



**Reason**

**OPERATION MANUAL**

# propellerhead

The information in this document is subject to change without notice and does not represent a commitment on the part of Propellerhead Software AB. The software described herein is subject to a License Agreement and may not be copied to any other media except as specifically allowed in the License Agreement. No part of this publication may be copied, reproduced or otherwise transmitted or recorded, for any purpose, without prior written permission by Propellerhead Software AB.

©2015 Propellerhead Software and its licensors. All specifications subject to change without notice. Reason, Reason Essentials and Rack Extension are trademarks of Propellerhead Software. All other commercial symbols are protected trademarks and trade names of their respective holders. All rights reserved.

# **Table of Contents**

## **Introduction 23**

### **Welcome! 24**

### **About this chapter 24**

### **About this manual 24**

### **About the Reason operating system versions 24**

### **Conventions in the manual 24**

### **The Authorization system 26**

Registering Reason 26

Running Reason with Internet Verification 27

Authorizing your Computer/Ignition Key (for off-line use) 27

About deauthorizing the computer/Ignition Key 28

Running Reason on an authorized computer - or with an authorized Ignition Key hardware 28

Running Reason in Demo Mode 29

### **Reassigning the Function Keys in Mac OS X 30**

### **About automatic program updates 31**

## **Common Operations and Concepts 33**

### **About this chapter 34**

### **Areas, windows and basic navigation 34**

Song window overview 34

The Browser 35

The Main Mixer 36

The Rack 37

The Sequencer 38

The Transport Panel 39

The ReGroove Mixer 39

Navigating between the areas 40

Showing/hiding the Navigators 40

Using several Reason Song windows 40

The Tool Window 41

The On-screen Piano Keys window 42

### **General window techniques 43**

Resizing 43

Scrolling 44

Zooming in the Sequencer 45

Scrolling and zooming using a wheel mouse 46

### **Editing parameters 47**

Knobs 47

Faders and sliders 48

Buttons 48

Fold/Unfold buttons 49

Multi Mode selectors 49

Numerical controls 50

Alpha-numeric controls 50

Numerical segment displays 51

### **Tool Tips 52**

### **Context menus 53**

Parameter context menus 53

Device context menus 54

Main Mixer channel strip context menu 55

Rack "background" context menu 56

Main Mixer "background" context menu 56

Sequencer context menus 56

### **Undo and Redo 57**

## **On-screen Piano Keys 59**

### **About this chapter 60**

### **Using the On-screen Piano Keys 60**

Opening the Piano Keys window 60

Mouse mode 61

Computer Keys mode 62

## **Audio Basics 65**

### **About this chapter 66**

### **How Reason communicates with your audio hardware 66**

Manual audio routing 67

Audio quality 67

Audio settings 68  
About audio levels 70

## System signal paths 73

Audio Track signal paths 73  
Instrument Track signal paths 74

## General information about audio and computers 75

About latency 75  
About processors 76  
About RAM 76

## Sequencer Functions 77

### About this chapter 78

### Introduction 78

### Sequencer area overview 78

Song View and Edit Mode 79  
Toolbar overview 80  
Track List overview 80  
Tracks overview 81  
Lanes overview 81  
Clips overview 82  
Inspector overview 82  
Ruler overview 82  
Edit/Arrangement Pane overview 82  
Track scrollbar overview 83  
Song Navigator overview 83  
Transport Panel overview 83

### Track details 84

Track definition 84  
The relationship between the track, the rack and the Main Mixer 85  
Master Keyboard Input 90  
The relationship between tracks, lanes, clips and events 91  
Track types 91  
Track List elements 93  
Creating tracks 93  
Selecting tracks 97  
Moving tracks 98  
Deleting tracks 98  
Duplicating/copying tracks and devices 99  
Coloring tracks 100

Naming tracks 100  
Folding tracks 100  
Muting tracks 101  
Soloing tracks 101

### Lane details 102

Audio lane 102  
Note lane 103  
Parameter automation lane 104  
Pattern lane 105  
Creating/adding lanes 106  
Deleting lanes 108  
Moving note lanes 109  
Copying (duplicating) note lanes 109  
Muting lanes 110

### Clip basics 110

Clip types 110

### Toolbar details 111

Toolbar tools 111  
Alternate tools 113  
Snap 114  
Sequencer Toolbar keyboard shortcuts 115

### Ruler details 115

### Transport Panel details 116

Transport keyboard commands 119

### About the Inspector 121

About subticks in the Position and Length displays 121  
About the “Match Values” function 121

## Recording in the Sequencer 123

### About this chapter 124

### General recording functions 124

Record enabling 124  
Click and Pre-count 128  
Loop mode 130  
General recording procedure 131  
Undoing a recording 132  
Recording tips 132

## **Audio recording details 132**

- Setting up the audio track 132
- Recording audio 137
- Recording audio in Loop mode 139
- Overdubbing audio using the “Dub” function 140
- Duplicating audio tracks using the “Alt” function 140
- Recording over or into an existing audio clip 141
- Recording audio from Mix Channel outputs 142
- Recording a mixdown of several audio tracks 144

## **Note recording details 148**

- Setting up the instrument track 148
- Recording notes 148
- Recording notes in Loop mode 148
- Recording over or into an existing note clip 149
- Recording notes using the “Dub” and “Alt” functions 150

## **Parameter automation recording details 152**

- Performance controllers vs. track parameter automation 152
- Recording performance controller automation 153
- Recording parameter automation into Note Clips 154
- Recording performance controller automation over or into an existing clip 154
- About performance controller automation on multiple lanes 155
- Recording parameter automation 155
- Recording parameter automation in Loop mode 156
- Recording parameter automation over or into an existing clip 157
- Adjusting automated parameters during playback - “Live mode” 158
- Recording parameter automation on multiple tracks 158

## **Pattern automation recording details 159**

- Recording pattern automation 159

## **Tempo automation recording 160**

- Recording tempo automation 160

## **Arranging in the Sequencer 163**

### **About this chapter 164**

## **Clip handling 164**

- Creating Clips 164
- Selecting clips 164
- Setting audio clip Level and Fades 167
- Deleting clips 168
- Resizing (masking) clips 169
- About masked recordings and events 170
- Tempo scaling clips 172
- Moving clips 174
- About overlapping clips 176
- Duplicating clips 176
- Cutting, Copying and Pasting clips 176
- Naming clips 177
- Coloring clips 177
- Splitting clips 178
- Joining clips 179
- Muting clips 181
- Merging clips on note lanes 181
- Matching clips using the “Match Values” function 182

## **Inserting bars 184**

## **Removing bars 184**

- About removing bars that contain audio recordings 185

## **Audio Editing in the Sequencer 187**

### **About this chapter 188**

## **Clip Modes and Editing 188**

- Inline editing vs. the Comp Editor (Edit Mode) 188
- Clip Modes 188
- Opening audio clips for editing 189

## **Editing audio inline 190**

- Preparing audio clips for inline editing 190
- Audio clip elements inline 191
- Inline audio editing tools 191
- Selecting Slices and Slice Markers 192
- Adding Slice Markers 193
- Deleting Slice Markers 193
- Repositioning Slice Markers 194
- Moving/stretching Slices 194
- Nudging Slices 196
- Quantizing audio 196

Split at Slices [197](#)  
Bounce Clip to REX Loop [197](#)  
Revert Slices [198](#)

## **Editing audio in the Comp Editor [199](#)**

Audio clip elements in the Comp Editor [199](#)  
The relationship between Clips, Comp Rows and Recordings [203](#)  
Comp Editor window handling [205](#)  
Comp Editor audio editing tools [205](#)  
Selecting a Comp Row for playback in a Single Take clip [206](#)  
Selecting Comp Rows [207](#)  
Deleting Comp Rows [208](#)  
Moving Comp Rows [208](#)  
Duplicating Comp Rows [208](#)  
Cutting, copying and pasting Comp Rows [209](#)  
Adjusting the Comp Row Level [209](#)  
Adjusting the Recording Offset [210](#)  
Delete Unused Recordings [210](#)  
Bounce Clip(s) to New Sample(s) [211](#)  
Normalizing Clips [212](#)  
Reversing Clips [213](#)

## **Comping audio [214](#)**

Adding Cuts [214](#)  
Adding Segments [215](#)  
Adding Crossfades to Cuts [215](#)  
Deleting Cuts [216](#)  
Moving Cuts [216](#)  
Changing Comp Row assignments [217](#)  
Bounce Clip(s) to New Recording(s) [218](#)  
Creating a comped audio clip [219](#)  
Turning Comp clips into Single Take clips [223](#)

## **Changing the tempo and transposition of the audio [223](#)**

Selecting Stretch and Transpose Type [223](#)  
Tempo scaling Clips [223](#)  
Transposing Audio Clips [225](#)

## **Audio and tempo matching [227](#)**

Matching an imported audio clip to the song tempo [227](#)

## **Editing audio using the Inspector [228](#)**

Editing recordings and cuts in the Inspector [228](#)  
Matching audio values using the "Match Values" function [228](#)

# **Note and Automation Editing [231](#)**

## **About this chapter [232](#)**

### **The Edit Mode [232](#)**

Selecting what to edit [233](#)  
Opening note and automation clips for editing [233](#)  
Edit Mode elements [235](#)  
Edit Mode window handling [237](#)  
Note Edit Modes [237](#)  
Creating empty clips [240](#)

## **Tool Window editing tools [241](#)**

### **Note editing [242](#)**

Selecting notes [242](#)  
Drawing notes [243](#)  
Deleting notes [245](#)  
Resizing notes [245](#)  
Moving notes [248](#)  
Duplicating notes [251](#)  
Using Cut, Copy and Paste [252](#)  
Quantize [253](#)  
Pitch (Transpose) [256](#)  
Extract Notes to Lanes [257](#)  
Scale Tempo [260](#)  
Editing note velocity [261](#)

### **Automation editing [263](#)**

Overview [263](#)  
Editing parameter automation [263](#)  
Drawing parameter automation events [266](#)  
Deleting automation events [267](#)  
Editing performance controller automation [267](#)  
About Automation Cleanup [269](#)  
Editing pattern automation [270](#)  
Drawing pattern automation [271](#)  
Moving, resizing and duplicating pattern automation clips [272](#)  
Deleting pattern automation clips [272](#)  
The "Convert Pattern Automation to Notes" function [273](#)  
Editing tempo automation [273](#)  
About tempo changes and tempo automation of audio tracks [274](#)  
Automating time signature [275](#)  
Moving, resizing and duplicating time signature automation clips [276](#)  
Deleting time signature automation clips [276](#)

## Note and automation editing in the Inspector 277

Editing notes and events in the Inspector 277  
Matching notes or events using the “Match Values” function 277

## Working with Blocks in the Sequencer 281

### About this chapter 282

#### Introduction 282

The idea behind Blocks 282

#### Arrangement Views 283

Song View (with Blocks disabled) 283  
Song View (with Blocks enabled) 283  
Block View 284

#### Editing Blocks in the Block View 284

Selecting a Block for editing 284  
Renaming Blocks 285  
Defining the Block length 285  
Changing Block color 285  
Recording in the Block View 285  
Editing clips in the Block View 285  
Arranging clips in the Block View 286

#### Arranging Blocks in the Song View 286

Creating Block Automation Clips 286  
Resizing Block Automation Clips 288  
Reassigning Blocks in Block Automation Clips 288  
Muting lanes in Block Automation Clips 289  
Converting Block Automation Clips to Song Clips 291  
Combining Block Automation Clips with Song Clips 293

## Working with the Rack 297

### About this chapter 298

#### Rack device procedures 298

Navigating in the rack 298  
Resizing and detaching the rack 299  
About Device Groups 300

Creating devices 302  
Selecting devices 304  
Deleting devices 306  
Re-ordering devices 306  
Re-routing devices 308  
Creating new rack columns 308  
About the “Sort Selected Device Groups” function 308  
Replacing devices 309  
Duplicating devices 310  
Cut, Copy and Paste devices 310  
Naming devices 311  
Folding and unfolding devices 312

## Working with Rack Extensions 313

### About this chapter 314

#### What are Rack Extensions? 314

Future compatibility 314

#### Trying and buying Rack Extensions 314

Trial versions of Rack Extensions 314  
Buying Rack Extensions 314

#### Installing and managing Rack Extensions 315

#### Using Rack Extensions in Reason 316

About missing Rack Extensions 318

## Sounds, Patches and the Browser 319

### About this chapter 320

#### About patches 320

Reason devices that use patches 320  
Loading patches 321  
Setting browse focus 324  
Saving patches 325  
Copying and pasting patches between devices 326  
Initializing patches and resetting device parameters 326



## About ReFills 327

## Using the Browser 328

- Opening the browser 329
- Browser elements 330
- Navigating in the Browser 334
- Using Locations and Favorites 336
- Favorites Lists 336
- Selecting and auditioning samples and REX loops 339
- Selecting multiple files 339
- Cross-browsing patch files 340
- Create Instrument/Create Effect 341
- About patch formats and sampler devices 341
- Using the “Search” function 342
- Loading files 342
- About browse lists 343
- Handling Missing Sounds 344
- Reason file formats 346

## Routing Audio and CV 349

### About this chapter 350

### Signal types 350

- Audio signals 350
- CV/Gate signals 350
- P-LAN signals 351
- About MIDI routing 351

### About cables 351

- Cable appearance 351
- Checking and following cable connections 352
- Cable color 353

### Automatic routing 353

- Auto-routing of audio input signals 353
- Auto-routing of Instrument devices 354
- Auto-routing of Effect devices 354
- Auto-routing of CV/Gate signals 355
- Auto-routing devices after they have been created 355
- About re-routing devices in songs created in Reason Version 5 or earlier 356

### Manual routing 357

- Connecting cables 358
- Connecting cables using pop-up menus 358
- Disconnecting cables 359
- Disconnecting devices 359

## Using CV and Gate 360

- Routing CV and Gate signals 360
- About CV Trim knobs 360

## The Main Mixer 361

### About this chapter 362

### Overview 362

- The Audio Track, its device and mixer channel strip 363
- The Mix Channel device and channel strip 364
- The Master Section device and mixer strip 365

### Navigating in the Main Mixer 366

- Viewing the Main Mixer area 366
- Scrolling and navigating in the Main Mixer 366
- Showing and hiding channel strip sections 367
- Switching between channels, rack devices and tracks 368

### Managing mixer channels 369

- Creating and deleting channels 369
- Selecting channels 369
- Moving channels 370
- Copying and duplicating channels 370
- Copy channel settings 371
- Resetting channel settings 371
- Naming mixer channels 371
- Coloring mixer channels 372

### The channel strip 373

- Input section 373
- Dynamics section 374
- EQ section 377
- The Spectrum EQ Window 378
- Insert FX section 381
- FX Sends section 382
- Fader section 383
- Channel Header section 384

### The Master Section strip 385

- Master Compressor section 386
- FX Send section 387
- Master Inserts section 388
- FX Return section 389
- Master Fader section 390
- Master Section Header 391

## **Automating mixer parameters 391**

## **Working with effects 391**

Insert FX 391  
Send FX 396

## **Output Busses 399**

Creating an Output Bus 399  
Deleting an Output Bus 401  
Recording a sub-mix onto an audio track 402

## **Parallel Channels 403**

Creating Parallel Channels 403  
Deleting Parallel Channels 406  
Naming Parallel Channels 406

## **Solo, Mute and Send FX logic 407**

Solo and Mute logic 407  
Send FX level and mute logic 409

## **Remote controlling the Main Mixer 411**

Remote controlling a single mixer channel 411  
Remote controlling multiple mixer channels 411

## **Advanced routing tips and tricks 414**

Chaining Send effects from Redrum or Mixer devices 414  
Using compression sidechaining 416  
Using the Mix Channel and Audio Track devices' Direct Outs 417  
Creating an input channel for recording with effects 418

## **Song File Handling 421**

### **About this chapter 422**

### **Opening Songs 422**

Opening a Reason or Record Song 422  
Opening a Reason Demo Song 423  
Opening the last Song at program launch 423

### **Closing Songs 424**

Closing a Song 424

### **Creating Songs 424**

Creating a new Song 424  
Setting up a Default Song 424  
Creating a new Song from a template 425

## **Saving Songs 425**

Saving a Song 425  
Saving and optimizing a Song 426  
Including Song Information 426  
About Self-Contained Songs 427  
Making a Song appear as a Template Song 428  
A note about saving Songs as audio files 428

## **Audio data and Scratch Disk settings 429**

About audio data in Song files 429  
Changing Scratch Disk folder location 429  
About "Orphan Audio Streams" 430

## **Importing and exporting Standard MIDI Files 430**

Importing Standard MIDI Files 430  
Exporting Standard MIDI Files 431

## **Importing and Exporting Audio 433**

### **About this chapter 434**

### **Importing audio 434**

Audio formats, sample rates and tempo matching 434  
About tempo matching imported audio 434  
Importing audio to the sequencer 435

### **Exporting audio 438**

Exporting Songs or parts of Songs 438  
Bouncing Mixer Channels 440  
Bouncing Audio Clips 442  
Drop to Propellerhead 444

## **Sampling 447**

### **About this chapter 448**

### **Overview 448**

One-click sampling 448  
The Edit Sample window 448  
About sample format, rate and resolution 449

### **General sampling functions 449**

Setting up for sampling 449

## **Sampling 451**

The Sample buttons 451  
Sampling procedure 451  
The Song Samples location 454

## **Editing samples 456**

The Edit Sample window 456  
Setting Sample Start and End 458  
Cropping samples 460  
Normalizing samples 460  
Reversing samples 460  
Fading in/out samples 461  
Looping samples 462  
Saving edited samples 464  
Renaming samples 464

## **Sample management 465**

About Assigned and Unassigned samples 465  
Saving samples in a song 466  
Deleting samples from a song 466  
Loading samples into a device 467  
Duplicating samples 468  
Exporting samples 469  
About self-contained samples 471

## **The ReGroove Mixer 473**

### **Introduction 474**

ReGroove basics 474

### **The ReGroove Mixer 475**

Global parameters 475  
Channel parameters 476  
Copy, Paste and Initialize ReGroove channels 480

### **Groove Settings 481**

### **Working with grooves 484**

Applying grooves to your music 484  
Commit to Groove - making the grooves "permanent" 487  
Creating your own ReGroove patches 488

### **Groovy tips & tricks 489**

## **ReGroove patches in the Factory Sound Bank 490**

## **Remote - Playing and Controlling Devices 491**

### **About the various MIDI inputs 492**

### **About Remote 492**

### **Setting up 493**

Adding a control surface or keyboard 493  
Other functions 495  
Example Setups 495

### **Remote basics 496**

About Standard vs Remote Override mapping 497  
About mapping variations 497

### **Locking a surface to a device 498**

Locking a surface 498  
Unlocking a surface 500

### **Remote Override 501**

Activating Remote Override Edit mode 501  
Remote Override mapping 502

### **Additional Remote Overrides... 505**

Assigning Additional Overrides 506

### **Keyboard Control 507**

Enabling Keyboard Control 507  
Editing Keyboard Control 507

### **Saving Remote Setups 508**

## **ReWire 509**

### **About this chapter 510**

### **Why use Reason with ReWire? 510**

### **Introducing ReWire! 510**

In ReWire version 1 510  
In ReWire 2 510

## **How does it work? 510**

Terminology 511

About system requirements 511

About synchronization 511

## **Launching and quitting applications 511**

## **Using the Transport and Tempo controls 512**

## **Routing audio 512**

Preparations in Reason 512

Routing in the ReWire host application 513

## **Routing MIDI via ReWire 2 513**

## **Converting ReWire channels to audio tracks 514**

## **Details about various ReWire hosts 514**

# **Synchronization and Advanced MIDI 515**

## **About this chapter 516**

## **Synchronization to MIDI Clock 516**

ReWire users – read this! 516

What is synchronization and MIDI Clock? 516

Using Reason as MIDI Clock master 516

Slaving Reason to an external MIDI application or instrument 518

Slaving Reason to another program on the same computer 518

External synchronization considerations 519

## **Advanced MIDI - The External Control Bus inputs 521**

About the External Control Bus inputs 521

Routing MIDI to devices 522

Receiving Controller data via MIDI 522

About recording Pattern Changes 522

# **Optimizing Performance 523**

## **Introduction 524**

Checking Processing Power 524

## **Optimization and latency reduction 524**

About Latency Compensation 525

## **Optimizing your computer system 526**

## **Optimizing Songs 528**

## **RAM requirements 530**

# **Hardware Interface 531**

## **Introduction 532**

About using ReWire 533

## **Sampling Input section 533**

## **Advanced MIDI Device 534**

## **More Audio 534**

## **The Big Meter 535**

# **The Combinator 537**

## **Introduction 538**

## **Creating Combinator devices 539**

## **Combinator elements 540**

## **About internal and external connections 541**

About External Routing 541

## **Adding devices to a Combi 543**

About the Insertion line 543

Creating new devices in a Combi 543

Adding devices using drag and drop [544](#)  
Adding devices using copy/paste [545](#)  
Adding a Combi to a Combi [545](#)  
Combining two Combis [545](#)  
Combining devices in a Combi with devices in the rack [545](#)

## **Combi handling [545](#)**

Moving the entire Combi [545](#)  
Moving devices within a Combi [546](#)  
Moving devices out of a Combi [546](#)  
Deleting devices in a Combi [546](#)  
Uncombining devices [546](#)

## **Sequencer tracks and playing Combis [546](#)**

## **The Controller panel [547](#)**

Select backdrop... [548](#)

## **Using the Programmer [549](#)**

Key Mapping instrument devices [550](#)  
Setting Velocity Ranges for instrument devices [551](#)  
Using Modulation Routing [552](#)  
CV Connections [555](#)

## **Mixer 14:2 [557](#)**

### **Introduction [558](#)**

### **The Channel Strip [558](#)**

Channel Strip Controls [559](#)

### **The Mixer signal flow [560](#)**

### **About the EQ modes [560](#)**

### **The Auxiliary Return Section [561](#)**

### **The Master Fader [561](#)**

### **Connections [561](#)**

### **Chaining several Mixer 14:2 devices [563](#)**

## **The Line Mixer 6:2 [565](#)**

### **Introduction [566](#)**

### **Channel parameters [566](#)**

### **The Auxiliary Return section [566](#)**

### **Master level [566](#)**

### **Connections [567](#)**

## **ID8 Instrument Device [569](#)**

### **Introduction [570](#)**

The Sounds [570](#)  
The ID8 and Standard MIDI Files [570](#)

### **Using the ID8 [571](#)**

Selecting Sounds [571](#)  
Controlling Sounds [571](#)  
About saving edited Sounds [572](#)

## **Subtractor Synthesizer [573](#)**

### **Introduction [574](#)**

Loading and Saving Patches [574](#)

### **The Oscillator Section [575](#)**

Oscillator 1 Waveform [575](#)  
Setting Oscillator 1 Frequency - Octave/Semitone/Cent [577](#)  
Oscillator Keyboard Tracking [577](#)  
Using Oscillator 2 [577](#)  
Oscillator 2 Waveform [578](#)  
Noise Generator [578](#)  
Phase Offset Modulation [579](#)  
Frequency Modulation (FM) [581](#)  
Ring Modulation [582](#)

### **The Filter Section [583](#)**

Filter 1 Type [583](#)  
Filter 1 Frequency [586](#)  
Resonance [586](#)

Filter Keyboard Track (Kbd) 586  
Filter 2 587

## **Envelopes - General 588**

Amplitude Envelope 589  
Filter Envelope 589  
Mod Envelope 590

## **LFO Section 591**

LFO 1 Parameters 591  
LFO 2 Parameters 592

## **Play Parameters 593**

Velocity Control 593  
Pitch Bend and Modulation Wheels 594  
Legato 595  
Retrig 595  
Portamento (Time) 595  
Setting Number of Voices - Polyphony 596  
About the Low Bandwidth button 596

## **External Modulation 596**

### **Connections 597**

Audio Output 597  
Sequencer Control 597  
Modulation Inputs 598  
Modulation Outputs 598  
Gate Inputs 598

## **Thor Polysonic Synthesizer 599**

### **Introduction 600**

Loading and Saving Patches 600

### **Thor elements 601**

### **The Controller panel 602**

### **Using the Programmer 604**

Basic connections - a tutorial 605  
The Oscillator section 608  
Mix section 615  
Filter slots 615  
Shaper 619  
Amp section 619

LFO 1 620  
Envelope sections 621  
Global section 622

## **Modulation bus routing section 624**

### **Step Sequencer 633**

Basic operation 633

### **Connections 637**

## **Malström Synthesizer 639**

### **Introduction 640**

Features 640  
Theory of operation 641  
Loading and Saving Patches 641

### **The Oscillator section 642**

Setting oscillator frequency 643  
Controlling playback of the graintable 643  
The amplitude envelopes 644

### **The Modulator section 645**

Modulator parameters 645  
Destinations 646

### **The Filter section 647**

The Filters 648  
The Filter Envelope 650  
The Shaper 651

### **Routing 653**

Routing examples 654  
The output controls 657

### **The play controls 657**

Polyphony - setting the number of voices 658  
Porta (portamento) 658  
Legato 658  
The Pitch Bend and Modulation wheels 659  
The Velocity controls 659  
The Modulation wheel controls 660

### **Connections 661**

Audio Output 661  
Audio Input 661

Sequencer Control [661](#)  
Gate Input [662](#)  
Modulation Input [662](#)  
Modulation Output [662](#)

## **Routing external audio to the filters [663](#)**

# **NN-19 Sampler [665](#)**

## **Introduction [666](#)**

### **General sampling principles [666](#)**

Background [666](#)  
Multisampling vs. single samples [666](#)

### **About audio file formats [667](#)**

Loading a Sample Patch [667](#)  
Loading REX Files as Patches [668](#)

## **Sampling in NN-19 [668](#)**

### **About Key Zones and samples [669](#)**

Loading a Sample into an empty NN-19 [669](#)  
Loading SoundFont samples [670](#)  
Loading REX slices as samples [670](#)  
Creating Key Zones [670](#)  
Selecting Key Zones [671](#)  
Setting the Key Zone Range [671](#)  
Deleting a Key Zone [672](#)  
About Key zones, assigned and unassigned samples [672](#)  
Adding sample(s) to a Key Map [672](#)  
Setting the Root Key [673](#)  
Removing sample(s) from a Key Map [673](#)  
Removing all unassigned samples [673](#)  
Rearranging samples in a Key Map [673](#)  
Setting Sample Level [673](#)  
Tuning samples [673](#)  
Looping Samples [674](#)  
About the Solo Sample function [674](#)

### **Automap Samples [675](#)**

Mapping samples without Root Key or Tuning information [675](#)  
How Mapping Information is saved [675](#)

## **NN-19 synth parameters [676](#)**

The Oscillator Section [676](#)  
The Filter Section [677](#)  
Envelope Section [678](#)  
LFO Section [679](#)

## **Play Parameters [681](#)**

Velocity Control [681](#)  
Pitch Bend and Modulation Wheels [681](#)  
Legato [682](#)  
Retrig [682](#)  
Portamento (Time) [682](#)  
Setting Number of Voices - Polyphony [683](#)  
Voice Spread [683](#)  
Low Bandwidth [683](#)  
Controller Section [683](#)

## **Connections [684](#)**

Audio Outputs [684](#)  
Mono Sequencer Control [684](#)  
Modulation Inputs [684](#)  
Modulation Outputs [684](#)  
Gate Inputs [685](#)

# **NN-XT Sampler [687](#)**

## **Introduction [688](#)**

## **Sampling in NN-XT [688](#)**

### **Panel overview [689](#)**

The main panel [689](#)  
The Remote Editor panel [689](#)

### **Loading complete Patches and REX files [690](#)**

Loading NN-XT Patches [690](#)  
Loading NN-19 Patches [690](#)  
Loading SoundFonts [691](#)  
Loading complete REX files as Patches [691](#)

### **Using the main panel [692](#)**

The Pitch and Modulation wheels [692](#)  
The External Control wheel [692](#)  
High Quality Interpolation [693](#)  
Global Controls [693](#)

## **Overview of the Remote Editor panel 695**

The Key Map display 695  
Sample parameters 696  
Group parameters 696  
Synth Parameters 697

## **About Samples and Zones 697**

### **Selections and Edit Focus 698**

Selecting Zones 699  
Moving Edit Focus 701

### **Adjusting parameters 701**

Adjusting Synth parameters 701  
Adjusting Group parameters 701  
Sample parameters 702

## **Managing Zones and Samples 703**

Creating a Key Map 703  
About file formats and REX slices 704  
Adding more samples to the Key Map 704  
Replacing a sample 704  
Quick browsing through samples 705  
Removing samples 705  
Auditioning samples 705  
Adding empty Zones 705  
Duplicating Zones 706  
Removing Zones 706  
Rearranging Zones in the List 706

## **Working with Grouping 706**

About Groups 706  
Creating a Group 706  
Moving a Group to another position in the List 707  
Moving a Zone from one Group to another 707  
Selecting a Group and/or Zones in a Group 708  
The Group Parameters 708

## **Working with Key Ranges 708**

About Key Ranges 708  
Setting up Key Ranges 708  
About the Lock Root Keys function 712  
About the Solo Sample function 713  
Sorting Zones by Note 714

## **Setting Root Notes and Tuning 715**

About the Root Key 715  
Setting the Root Note manually 715  
Tuning samples manually 715

Setting the Root Note and Tuning using pitch detection 716  
About changing the pitch of samples 716

## **Using Automap 716**

### **Layered, crossfaded and velocity switched sounds 717**

Creating layered sounds 717  
About velocity ranges 717  
Setting velocity range for a Zone 719  
About Crossfading Between Zones 719  
Setting crossfading for a Zone 721

### **Using Alternate 721**

About the Alternate function 721

## **Sample parameters 722**

Root Note and Tune 722  
Sample Start and End 722  
Loop Start and End 722  
Play Mode 723  
Lo Key and Hi Key 723  
Lo Vel and Hi Vel 723  
Fade In and Fade Out 723  
Alt 723  
Out 723

## **Group parameters 724**

Key Poly 724  
Legato and Retrigger 725  
LFO 1 Rate 725  
Portamento 725

## **Synth parameters 726**

The Modulation controls 726  
The Velocity controls 728  
The Pitch section 729  
The Filter section 730  
The Modulation Envelope 731  
The Amplitude Envelope 733  
The LFOs 734

## **Connections 737**

Sequencer Control 737  
Modulation Input 737  
Gate Input 737  
Audio Output 737



## **Dr. Octo Rex Loop Player 739**

### **Introduction 740**

ReCycled Loops 740

### **About REX file formats 741**

### **Loading and saving Dr. Octo Rex patches 741**

About the Dr. Octo Rex patch format 741

About opening songs that previously used Dr. Rex devices 741

### **Playing Loops 742**

Switching playback between Loop Slots 742

### **Adding Loops 743**

Loading Loops “On the Fly” 744

Removing Loops 744

Cut/Copy and Paste Loops between Loop Slots 744

### **Playing individual Loop Slices 744**

### **Creating sequencer notes 745**

### **Slice handling 748**

Selecting Slices 748

Editing individual Slices 748

Editing in the Waveform Display 749

The Slice Edit Mode 750

### **Dr. Octo Rex panel parameters 751**

Pitch and Mod wheels 751

Trig Next Loop 751

Note To Slot 751

Loop Slot buttons 752

Enable Loop Playback and Run 753

Volume 753

Global Transpose 753

### **Dr. Octo Rex synth parameters 754**

Select Loop & Load Slot 754

Loop Transpose 754

Loop Level 755

Oscillator section 755

Mod. Wheel 756

Velocity section 756

The Filter Section 757

Envelope section 758

LFO section 759

Pitch Bend Range 760

Setting number of voices - polyphony 761

Audio Quality settings 761

### **Connections 761**

Modulation Inputs 762

Modulation Outputs 762

Gate Inputs 762

Gate Output 762

Slice Outputs 762

Main Outputs 762

## **Redrum Drum Computer 763**

### **Introduction 764**

### **Sampling in Redrum 764**

### **About file formats 765**

### **Using patches 766**

Loading a patch 766

Checking the sounds in a patch 766

Creating a new patch 767

Creating an empty patch 767

### **Programming patterns 768**

Pattern basics 768

Pattern tutorial 769

Setting pattern length 770

Setting pattern resolution 771

Step dynamics 771

Pattern Shuffle 772

Flam 772

The Pattern Enable switch 773

The Enable Pattern Section switch 773

Pattern functions 774

Chaining patterns 774

Converting Pattern data to notes in the main sequencer 775

### **Redrum parameters 776**

Drum sound settings 776

Global settings 779

## Using Redrum as a sound module **780**

### Connections **781**

## Kong Drum Designer **783**

### Introduction **784**

#### Overview **784**

- The Pad Section [784](#)
- The Drum Control Panel [785](#)
- The Drum and FX Section [785](#)
- About using custom backdrops [785](#)

#### About file formats **785**

#### Using patches **786**

- Loading a Kit Patch [786](#)
- Checking the sounds in a Kit Patch [787](#)
- Creating a new Kit Patch [787](#)
- Creating an empty Kit Patch [788](#)
- Saving Kit Patches [788](#)

#### Pad Settings **789**

- Assigning Drums to Pads [789](#)
- Renaming Pads [790](#)
- Copying & Pasting Drums between Pads [790](#)
- Assigning Hit Type to Pads [790](#)
- Muting and Soloing Pads [791](#)
- Working with Pad Groups [792](#)

#### The Drum and FX section **793**

- Signal flow [794](#)
- The Drum Control Panel [796](#)
- Sampling in Kong [798](#)
- The Drum Module slot [798](#)
- The FX slots [799](#)

#### The Drum modules **800**

- NN-Nano Sampler [800](#)
- Nurse Rex Loop Player [804](#)
- Physical Bass Drum, Snare Drum and Tom Tom [809](#)
- Synth Bass Drum, Snare Drum and Tom Tom [811](#)
- Synth Hi-hat [812](#)

#### The Support Generator modules **813**

- Noise Generator [813](#)
- Tone Generator [814](#)

## The FX modules **815**

- Using CV modulation of Bus FX and Master FX parameters [815](#)
- Drum Room Reverb [816](#)
- Transient Shaper [816](#)
- Compressor [817](#)
- Filter [818](#)
- Parametric EQ [818](#)
- Ring Modulator [819](#)
- Rattler [820](#)
- Tape Echo [820](#)
- Overdrive/Resonator [821](#)

### Connections **822**

- Sequencer Control [822](#)
- Modulation Input [822](#)
- Aux Send Out [822](#)
- Gate In and Out [823](#)
- Audio Out 3-16 [823](#)
- Main Audio Out [823](#)

### Using Kong as an effect device **823**

### Using external effects with Kong **824**

## External MIDI Instrument **825**

### Introduction **826**

#### Using the External MIDI Instrument **826**

- Setting up for controlling an external MIDI instrument [826](#)
- Controlling the sound of your external MIDI instrument [827](#)
- Using MIDI Program Change [827](#)
- Recording MIDI Controller automation [828](#)

### Connections **833**

- Sequencer Control [833](#)
- Assignable CC [833](#)

### Tips & Tricks **833**

- Audio recording of MIDI controlled external instruments [833](#)

## **The MClass Effects 837**

### **The MClass effects 838**

### **The MClass Equalizer 839**

### **The MClass Stereo Imager 840**

### **The MClass Compressor 841**

### **The MClass Maximizer 844**

## **Line 6 Amps 845**

### **Introduction 846**

About the Amp Tones patch format 846

Basic usage 846

Front panel 847

### **Using the Line 6 Amps 848**

Selecting Patches (Amp Tones) 848

Selecting Amp and Cabinet model 849

About the Amp/Cabinet models 850

Amp Parameters 850

Additional parameters 850

Additional Line 6 Amp Models 851

Connections 852

## **Scream 4 Sound Destruction Unit 853**

### **Scream 4 Sound Destruction Unit 854**

Parameters 854

CV inputs and outputs 858

Screamy tips and tricks 859

## **Pulveriser 861**

### **Introduction 862**

About the Patch format 862

### **Parameters 862**

Common effect device parameters 862

Signal Routing selector 863

The Squash section 864

The Dirt section 864

The Filter section 865

The Tremor section 866

The Follower section 867

Blend 868

Volume 868

### **Modulation inputs and outputs 869**

CV Modulation inputs 869

Audio Modulation inputs 869

CV Modulation outputs 870

### **Demolition tips and tricks 870**

Beef up your sounds 870

Make your pads tremble 870

## **Alligator Triple Filtered Gate 871**

### **Introduction 872**

About the Patch format 872

### **Overview and signal flow 872**

### **Parameters 874**

Common effect device parameters 874

Pattern section 874

Gate and Amp Envelope 875

Filters and Modulation 876

Effects 878

Mix controls 880

### **Audio connections 881**

Main Inputs and Outputs 881

Separate Outputs 881

### **CV connections 882**

Gate inputs 882

CV Modulation inputs 882

Gate Outputs 882

LFO CV Out 882

### **The built-in patterns 883**

## **Methods and Tips 884**

Playing the Alligator live 884  
Playing the gates from Matrix patterns 884  
Controlling other sounds and effects 884

## **RV7000 Mk II Advanced Reverb 887**

### **Overview 888**

About the Patch format 888  
Connections 888  
The main panel 889  
The Remote Programmer 889

### **Reverb algorithms and parameters 890**

Common effect device parameters 890  
About the main panel parameters 890  
Selecting an algorithm 890  
Small Space 891  
Room 891  
Hall 892  
Arena 892  
Plate 892  
Spring 892  
Echo 893  
Multi Tap 893  
Reverse 894  
Convolution 895

### **The EQ section 898**

### **The Gate section 899**

### **CV Inputs 900**

## **The Echo 901**

### **Introduction 902**

About the Patch format 902

### **Parameters 902**

Common effect device parameters 902  
The Mode section 903  
The Delay section 904  
The Feedback section 905

The Color section 906  
The Modulation section 907  
The Output section 908

### **CV/Gate inputs 909**

### **The Breakout Jacks 909**

### **Tips and Tricks 910**

Using the Roll function 910  
Creating “pitched” delay 910  
Distorted external feedback 910

## **BV512 Vocoder 911**

### **Introduction 912**

How does a vocoder work? 912

### **Setting up for basic vocoding 913**

Vocoding vocals in real-time 913  
Vocoding an existing audio track 915

### **Using the BV512 as an equalizer 917**

### **BV512 parameters 918**

### **Connections 919**

### **Automation 920**

### **Tips and tricks 921**

Choosing a carrier sound 921  
Choosing a modulator sound 922  
Using the modulator as carrier 923  
Controlling the Hold function 924  
Using the individual band level connections 924  
“Playing” the vocoder from a MIDI keyboard 926  
Using the BV512 as a reverb 926

## **Neptune Pitch Adjuster and Voice Synth 929**

### **Introduction 930**

Typical use cases 930

## Overview and basic concepts 931

Sections overview 931

The display 932

## Setting up for pitch processing 932

Setting up for pitch processing of recorded audio tracks 932

Setting up for pitch processing of “live” audio 933

## Using pitch correction 933

Basic settings for pitch correction 934

Using automatic pitch correction 935

Using manual pitch correction 939

## Using pitch shifting (Transpose) 940

## Using Formant control 941

What are formants? 941

Using the Formant function 942

## Using the Voice Synth 942

## Panel parameters 943

Level Meter and Bypass/On/Off switch 943

Bend and Vibrato wheels 943

Input signal type 944

MIDI Input 944

Pitch Adjust section 945

Transpose section 946

Formant section 946

The Output Mixer section 946

## Connections 947

Sequencer Control 947

CV In 947

CV Out 948

Audio In 948

Voice Synth Out 948

Audio Out 948

## Pitch adjustment tips and tricks 949

Using automation for temporary pitch correction 949

Hard pitch correction of a vocal track 950

Pitch correction with changed voice character 950

Octave dub 950

Pitch-shifting drums (non-pitched input) 950

Speech effects 951

About “freezing” pitch adjustments on audio tracks 951

## Half-Rack Effects 953

### Common effect device features 954

### DDL-1 Digital Delay Line 956

### CF-101 Chorus/Flanger 957

### Spider Audio Merger & Splitter 959

### Spider CV Merger & Splitter 961

### RV-7 Digital Reverb 965

### D-11 Foldback Distortion 967

### ECF-42 Envelope Controlled Filter 968

### PH-90 Phaser 972

### UN-16 Unison 974

### COMP-01 Auto Make-up Gain Compressor 975

### PEQ-2 Two Band Parametric EQ 976

## Matrix Pattern Sequencer 977

### Introduction 978

About the three Output types 978

### Programming patterns 979

Pattern basics 979

Tutorial 982

Using Curve Patterns 984

Setting Pattern Length 985

Using Tied Notes 985

Setting Pattern Resolution 986

Pattern Shuffle 986

Pattern Mute 986

Pattern Functions 987

Chaining Patterns 987

Converting Pattern data to notes in the main sequencer 988

## **Example usage 989**

Using the Matrix for modulation 989  
Programming “Acid Style” lead lines 990  
Triggering samples 990

## **RPG-8 Arpeggiator 991**

### **Introduction 992**

### **Using the RPG-8 993**

Setting up 993  
Recording MIDI note data for the RPG-8 - simple tutorial 995  
Rendering arpeggio notes to track 997

### **RPG-8 Parameters 998**

MIDI-CV Converter parameters 998  
Arpeggiator parameters 999  
Pattern editor 1001

### **CV connections 1004**

### **Tips and tricks 1006**

## **ReBirth Input Machine 1007**

### **Information about ReBirth Input Machine 1008**

## **Menu and Dialog Reference 1009**

### **Reason menu (Mac OS X) 1010**

#### **File menu 1011**

#### **Edit menu 1015**

Preferences – General 1033  
Preferences – Audio 1036  
Preferences – Control Surfaces 1040  
Preferences - Sync 1043

Preferences – Advanced 1044  
Preferences - Language (Windows only) 1046

#### **Create menu 1047**

#### **Options menu 1048**

#### **Window menu (Windows version) 1052**

#### **Window menu (Mac OS X version) 1054**

#### **Help menu 1056**

## **Key Commands 1057**

### **About the Key Commands chapter 1058**

General keyboard shortcuts 1058  
General modifier keys 1059  
Transport keyboard shortcuts 1059  
Sequencer keyboard shortcuts 1060  
Sequencer modifier keys 1061  
Arrow keys 1062  
Save dialog keyboard shortcuts 1062  
On-screen Piano Keys keyboard shortcuts 1062  
NN-19 modifier keys 1063  
NN-XT keyboard shortcuts 1063  
NN-XT modifier keys 1063  
Dr. Octo Rex keyboard shortcuts 1063  
Dr. Octo Rex modifier keys 1063  
Redrum keyboard shortcuts 1063  
Redrum modifier keys 1064  
Kong modifier keys 1064  
Matrix keyboard shortcuts 1064  
Matrix modifier keys 1064  
RPG-8 keyboard shortcuts 1064  
External MIDI Instrument keyboard shortcuts 1064

## **Index 1065**

# **Chapter 1**

## **Introduction**

# Welcome!

This is the Operation Manual for Propellerhead's Reason Version 8.3 music production software. The information in this manual is also available as html files in the on-line Reason Help system.

If you haven't already, don't forget to check out the Video Tutorials web site, which can be accessed from the Reason Help menu.

Also, be sure to regularly check out the Propellerhead web site at [www.propellerheads.se](http://www.propellerheads.se) for the latest news!

## About this chapter

The Introduction chapter describes some of the general conventions used throughout the Reason Operation Manual. It also contains instructions on how to utilize the Reason authorization system.

## About this manual

In this Operation Manual, all aspects of the Reason program are described in detail. The first chapters deal with general methods and techniques, e.g. how to connect audio sources, mix and record. Then follow descriptions of all rack devices in Reason.

## About the Reason operating system versions

Propellerhead Reason comes in two platform versions: one for Windows 7 or later and one for Mac OS X 10.7 or later. The screenshots in this manual were taken from both platform versions of Reason, and some screenshots remain from older versions of Reason. Since the program layout is more or less identical in these versions, there shouldn't be any problem following the instructions.

## Conventions in the manual

This manual describes both the Windows and Mac OS X versions of Reason; wherever the versions differ this is clearly stated in the text.

### Text conventions

The text conventions are pretty straightforward. The examples below describe when certain text styles are used:

- **This style instructs the user to perform the task(s) described in the sentence.**
- ! **This text style means IMPORTANT INFORMATION. Read carefully to avoid problems!**
- **This text style is used for tips and additional info.**

### Key command conventions

In the manual, computer keyboard commands are indicated with brackets. For example:

- **Hold down [Shift] and press [C].**

However, some modifier keys are different on Windows and Mac computers. Whenever this is the case, the manual separates the commands with "(Win)" and "(Mac)" indications as in the following example:

- **Hold down [Ctrl](Win) or [Cmd](Mac) and press [S] to save your song.**



## References to context menus

Whenever the manual instructs you to select an item from the “context menu”, it means that you should right-click (or [Ctrl]-click if you're using a Mac with single-button mouse) on the specific area, section or device, and then select the item from the pop-up menu that appears - the context menu. The item list in context menus varies depending on where in the application you click. See “Context menus” for an overview of the context menus in Reason.

## Frames and circles (call-outs)



In pictures throughout this manual there might be circles and/or rectangles highlighting certain areas or objects. These are indicated by filled lines according to the examples in the picture above. Sometimes these highlighting frames/circles might also be accompanied by descriptive texts. The different colors of the frames and texts are only to enhance the contrast to the background pictures.

## Dashed arrows



A dashed arrow in a picture indicates the directions in which the pointer (or other tool) should be dragged to perform the desired operation. The example in the picture above shows in which directions (up and down) to drag the pointer to change the knob's setting.

# The Authorization system

Reason uses an authorization system designed to be as flexible as possible, while at the same time providing the best possible copy protection for the product. Here's how it works:

- **The core of the authorization system is your license number, which is registered to your user account on the Propellerhead web site.**
- **If you have a working Internet connection you can run Reason with Internet Verification.**  
The program will then contact the Propellerhead web site and verify that Reason is registered to your user account.
- **If you need to use Reason without Internet access, you can download and install the CodeMeter application and then authorize your computer (or Ignition Key hardware) from your Propellerhead user page.**  
During start-up Reason automatically detects that your computer is authorized.  
You can also choose to authorize an optional physical Ignition Key (USB stick) or Propellerhead Balance audio interface to run Reason in authorized mode, anywhere and on any computer.
- **Finally, if you don't have a working Internet connection, or any authorized computer or Ignition Key hardware, you can run Reason in Demo Mode.**  
This is also the mode you use if you are trying out the program, but haven't yet purchased it. In Demo Mode you can work as usual and even save your work. However, you cannot open songs in Demo Mode (for details, see ["Running Reason in Demo Mode"](#)).

## Registering Reason

To be able to run Reason in authorized mode (see ["Running Reason with Internet Verification"](#) and ["Running Reason on an authorized computer - or with an authorized Ignition Key hardware"](#)), the program must be registered to your account on the Propellerhead web site.

- **If you purchased the boxed version of Reason, follow the instructions printed on the DVD sleeve.**
- ! **If you purchased Reason directly from the Propellerhead web site, the Reason license has already been registered to your user account and you can use Reason by authorizing your computer or by running with Internet Verification.**

## Running Reason with Internet Verification

When you launch Reason on an unauthorized computer, or without an authorized Ignition Key hardware connected, the following window appears:

- ! **Note that this procedure requires a working Internet connection (and that your Reason license has been registered to your user account as described in “Registering Reason”).**

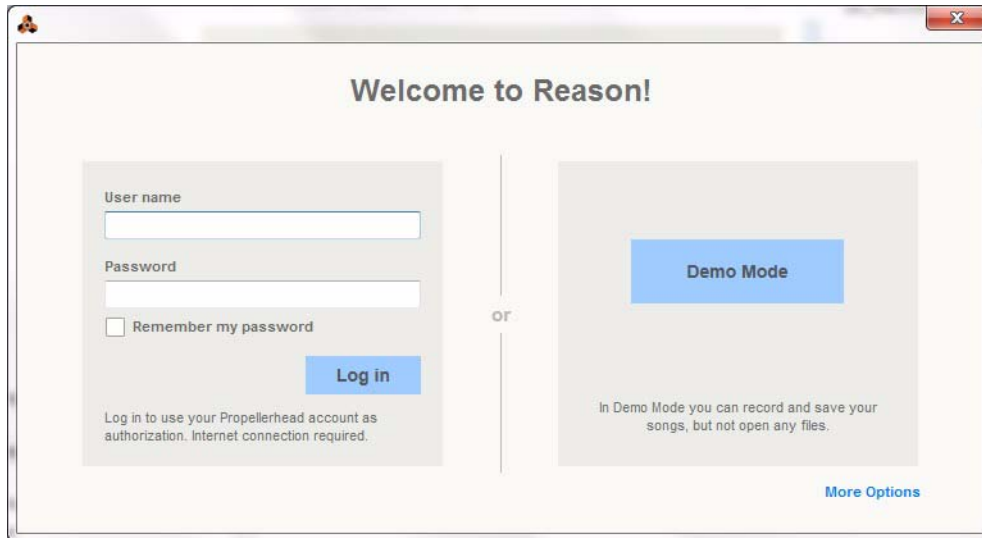

- **Enter the User name and Password for your Propellerhead account and click the Log in button.** Reason launches in Authorized Mode.
- ! **It is not possible to run two instances of Reason (on different computers) authorized to the same user account. Reason will then enter Demo Mode (see “Running Reason in Demo Mode”).**

## Authorizing your Computer/Ignition Key (for off-line use)

- ! **Note that a working internet connection is required to be able to perform the following steps.**

### 1. Launch Reason.

When you start Reason, this window is displayed:

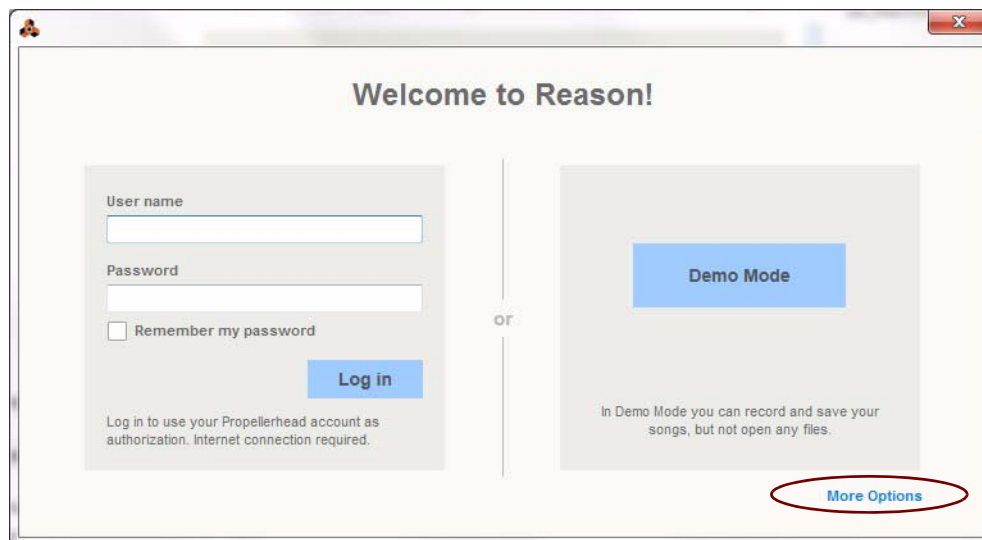

**2. Click on the “More Options” link.**

Your default web browser starts up and takes you to the More Options page on the Propellerhead web site, where the whole authorization process is described in detail.

**3. Follow the link on the web page to download and install Codemeter.**

If you are updating from a previous version of Reason, you may already have Codemeter installed on your computer. However, it's a good idea to download and install the latest version of the Codemeter driver.

**4. When done, return to the More Options page and click the Authorize Computer and Keys link.**

**5. When you launch Reason again, you will be able to run the program in Authorized mode, without having to log in.**

You can now quit the web browser if you like.

## About deauthorizing the computer/Ignition Key

You can have one computer and one Ignition Key authorized at a time. If you're moving your work from an authorized computer to another computer, you should first deauthorize the current computer and then authorize the other one. This is done from your account page at the Propellerhead web site:

**1. Log in on your currently authorized computer and go to your own "Products" page under the user menu.**

**2. Click the Authorize button.**

On the page that is shown, there should be a Deauthorize button next to the computer icon.

**3. Click the Deauthorize button next to the computer icon to remove the authorization from your computer.**

If you are using an authorized Ignition Key or Propellerhead Balance audio interface instead of an authorized computer, you can just move the Ignition Key/Propellerhead Balance from your old computer to your new one.

**! Remember to deauthorize your computer before updating the Operating System or before sending your computer to service or selling it!**

## Running Reason on an authorized computer - or with an authorized Ignition Key hardware

If you launch Reason on an authorized computer, or with an authorized Ignition Key hardware (Propellerhead USB stick or Propellerhead Balance audio interface) connected, the program will simply start without further ado.

- **If you are using an Ignition Key on an unauthorized computer, always connect the Ignition Key hardware before starting your computer and launching Reason. This way Reason will start up immediately, without the Authorization procedure.**

If you have an authorized computer, or an authorized Ignition Key hardware connected to your computer, it's no longer necessary to have Internet connection when running Reason.

## Running Reason in Demo Mode

If you don't have a Reason license, or if you don't have an authorized computer or your optional Ignition Key hardware at hand and don't have a working Internet connection, you can run Reason in Demo Mode:

### 1. Launch Reason.

The following window appears:

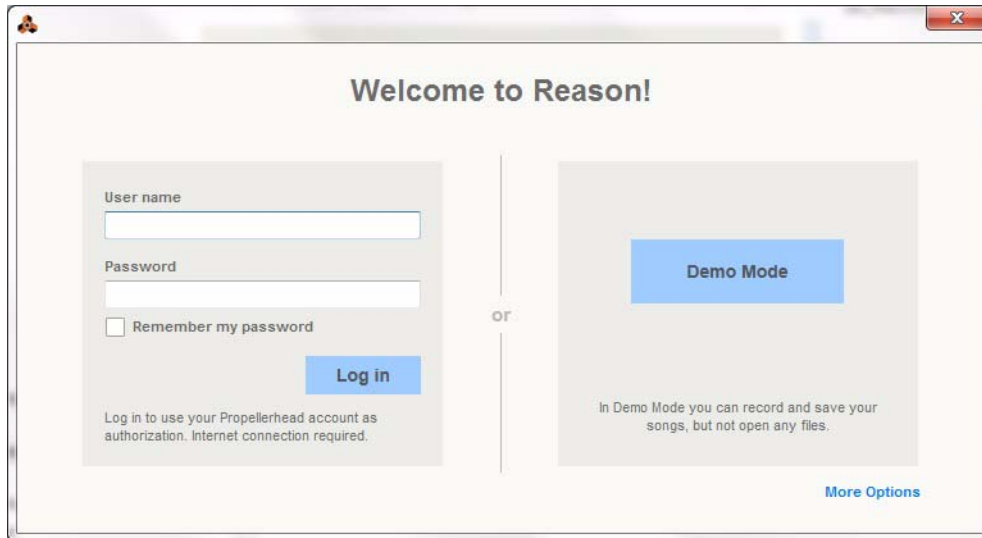

### 2. Click on the "Demo Mode" button.

Reason launches in Demo Mode.

The Demo Mode LED lights up to the right on the Transport Panel:



Running Reason in Demo Mode allows you to perform all operations as in Authorized Mode, with three exceptions:

- **You cannot export audio, drop files to Propellerhead or bounce mixer channels to disk.**
- **You will not have access to any Rack Extension devices.**
- **You cannot open songs.**

The only songs that can be opened in Demo Mode are the dedicated demo songs (file extension ".rsndemo", ".reedemo" and ".recdemo"). See ["Opening a Reason Demo Song"](#).

If you disconnect your Ignition Key hardware on an unauthorized computer, or lose the Internet Connection while running Reason with Internet Verification, the program will automatically enter Demo Mode. You can continue to work, and save your songs as usual. When you reconnect the Ignition Key hardware or reconnect to the internet, Reason will automatically revert to authorized mode and the Demo Mode indicator will go off.

# Reassigning the Function Keys in Mac OS X

When you work with Reason, you will do a lot of navigating between the three main areas - the main mixer, the rack and the sequencer. The quickest way to switch between these areas is to use the function keys F5, F6 and F7 (see ["Navigating between the areas"](#) for details). Also, the F2, F3, F4 and F8 keys are shortcuts for showing and hiding the Spectrum EQ window, Browser, On-screen Piano Keys window and the Tool Window, respectively.

However, on many Macintosh models (especially MacBooks), the function keys double as hardware control buttons. For example, they might control the volume of the built-in speaker, the display brightness or keyboard backlight. To make these keys actually work as function keys for software such as Reason, you need to hold the "Fn" key while pressing them.

This can work perfectly OK, but to get the best workflow in Reason we recommend that you change this behavior, so that pressing e.g. the F5 key actually sends "F5" to Reason (and you hold down the Fn key to get the hardware control functions instead). Here is how you change this:

**1. Open the System Preferences in Mac OS X and select the "Keyboard" item.**

The "Keyboard" preferences are shown.

**2. Select the "Keyboard" tab and make sure the checkbox "Use all F1, F2, etc. keys as standard function keys" is ticked.**

Now you can use F2-F8 for controlling functions in Reason. To use hardware control features such as volume and display brightness, you need to hold down the "Fn" key before pressing the function keys.

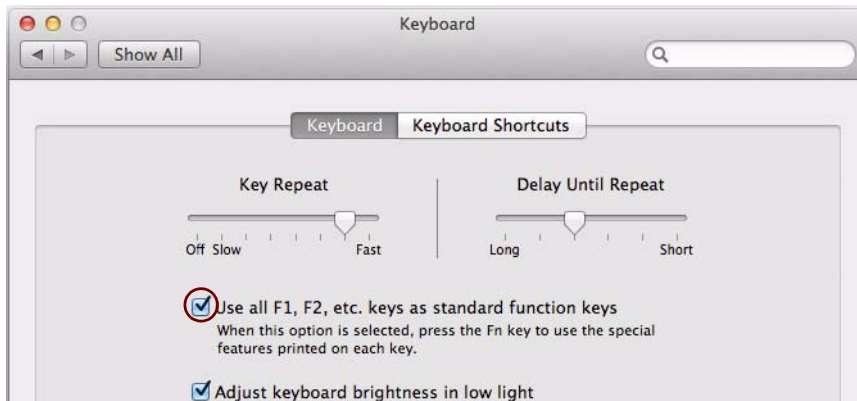

Some function keys might also be pre-assigned to Mac OS X keyboard shortcuts, which will have priority over software such as Reason. This is easily changed:

**3. Click the "Keyboard Shortcuts" tab in the "Keyboard" window.**

The Keyboard Shortcuts window shows lists of keyboard shortcuts assigned to system functions. For example, [Cmd]+[F5] is in the Accessibility group assigned to turn VoiceOver on or off. In Reason, this is the keyboard shortcut for detaching the main mixer into a separate window.

4. Scroll down to the "Turn VoiceOver on or off" item in the Accessibility group and either remove the tick from the checkbox or assign it to another keyboard shortcut.

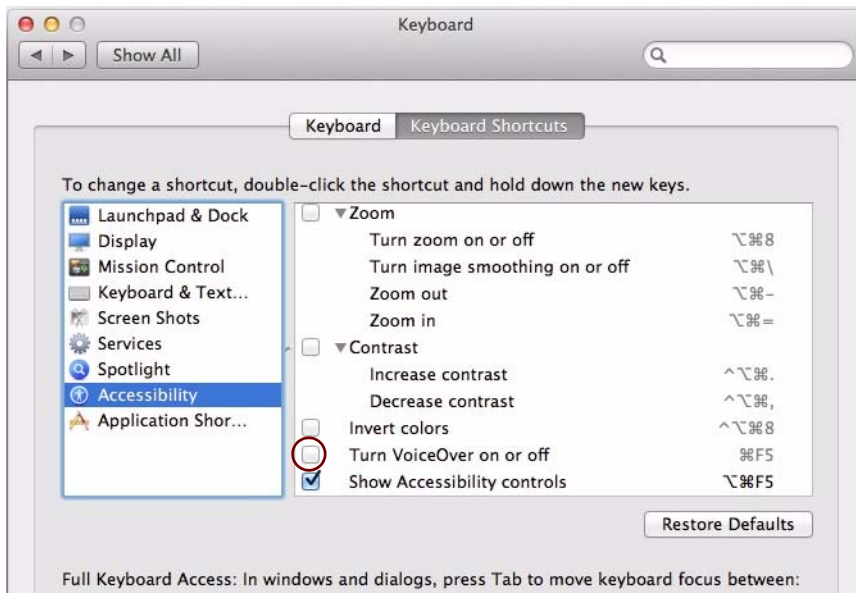

5. Now, you're finished with the settings and can close the "Keyboard" window.

From now on, the function keys and keyboard shortcuts will perform their intended functions in Reason.

## About automatic program updates

As from Version 8.2, Reason supports automatic program updates. When you launch Reason it automatically checks for new updates on the Propellerhead web site - provided your computer is connected to the Internet.

If you are working with Reason off-line, and then connect to the Internet, you can manually check for updates by selecting the "Check for Updates..." item on the Help menu.

Each time a new Reason version is available, an "update bar" becomes visible at the top of the Reason song document after launch. In the update bar you can choose to either download the update now or later:



If you click "Not Now" Reason will wait a number of days before it checks for updates again.

If you click “Download” the update is downloaded and prepared for installation. A download progress bar appears in the update bar:

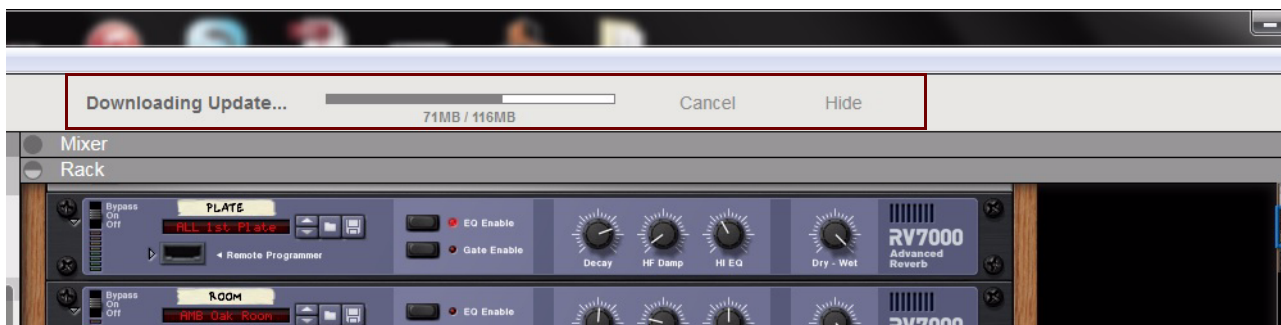

- If you want to abort the download, click “Cancel”.
- If you want to hide the download progress bar, click “Hide”.

When the download is ready, two options are available:

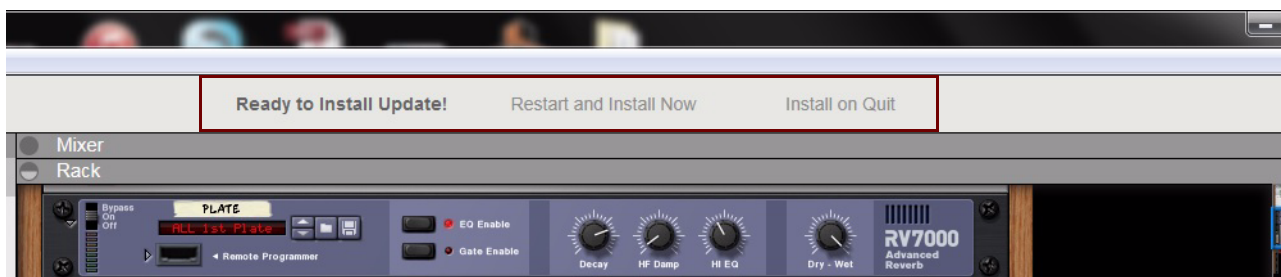

- Click “Restart and Install Now” to install the update and launch the updated version of Reason.
- Click “Install on Quit” to continue running the current Reason version and install the update after you quit the current Reason session.



**Chapter 2**  
**Common Operations**  
**and Concepts**

# About this chapter

This chapter gives a basic overview of the Reason application and describes general methods and techniques employed throughout the Propellerhead Reason software. It also explains the terminology used throughout the program, manuals and help files.

## Areas, windows and basic navigation

### Song window overview



A Reason Song window with its Browser, Main Mixer, Rack and Sequencer areas.

The Reason graphical user interface is divided into four main areas:

- **The Browser**  
The Browser is where you create devices, load patches into devices and load songs.
- **The Main Mixer**  
The Main Mixer is located at the top in the Reason Song window. Here are the channel strips for the audio and instrument tracks in your song.
- **The Rack**  
The Rack is where all sound and effects devices you use in your song are located. The Rack resembles a traditional hardware rack, where sound modules and effects units can be mounted.
- **The Sequencer**  
The Sequencer is where you record your audio and instrument tracks. Here you can also record automation of device parameters in the Rack and of channel strip parameters in the Main Mixer. The Sequencer also incorporates the Transport Panel, where all sequencer transport controls are located.

The areas can be viewed together, as in the picture above, in pairs or separately - see [“Navigating between the areas”](#). The areas can also be resized - see [“Resizing”](#).

# The Browser

The Browser to the left in the Song window (and also in the Rack window, if the Rack is detached) features shortcuts for creating devices, loading patches and songs, and sample management functions. By pressing [F3] you can toggle between Show and Hide Browser.

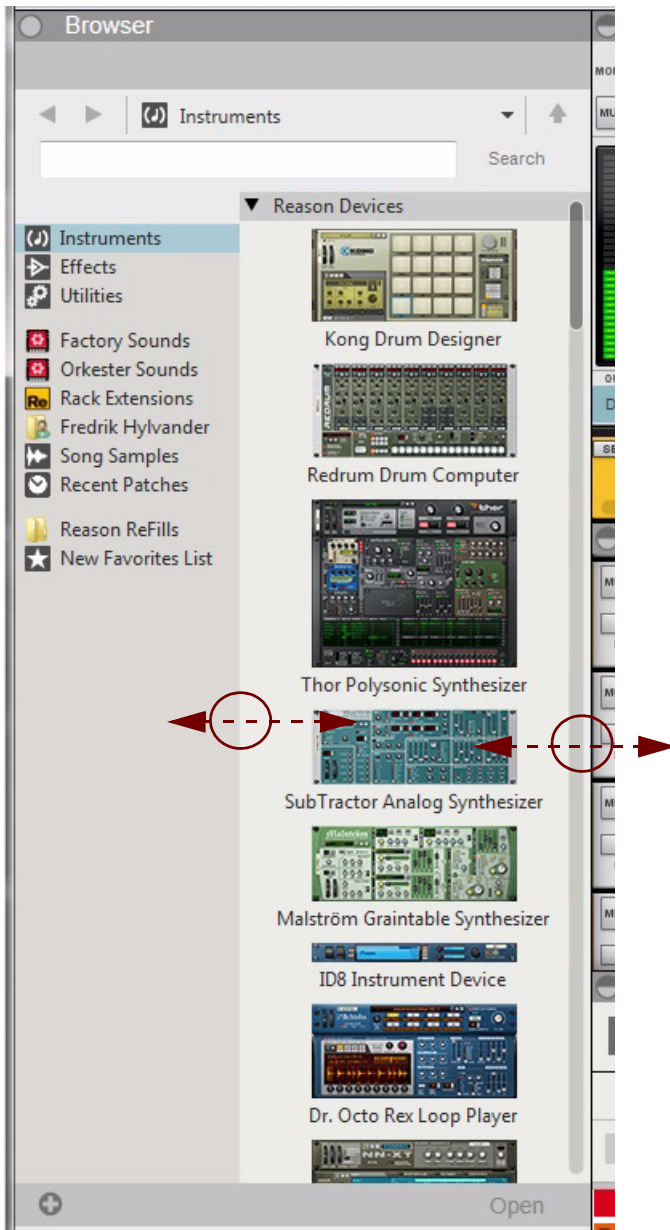

*The Browser with the Instruments palette selected.*

- See **“About using the Browser in the detached rack”** and **“Creating devices”** for information on how to use the **“Device”** functions.
- See **“Using the Browser”** for information on how to browse for patches and songs.
- See the **“Sampling”** chapter for information on how to use the **“Song Samples”** functions.

# The Main Mixer



The Main Mixer with the Fader sections currently scrolled into view.

In the Main Mixer, all channel strips of the Reason song are visible. You can scroll vertically in the Main Mixer by clicking and dragging inside the frame in the Channel Strip Navigator to the right. This way you will be able to access all channel strip parameters. If you have a lot of channels ins your song you can also scroll horizontally by clicking and dragging the Mixer scrollbar at the bottom of the Main Mixer area.

- **By pressing function key [F5], or by double clicking the gray Mixer header, you can maximize the Main Mixer area.**
- **To the right on the Mixer header is the Detach Main Mixer icon. Clicking this, or holding [Ctrl](Win) or [Cmd](Mac) and pressing [F5], will detach the Main Mixer and place it in a separate window.** This is especially useful if you are using multiple screens with your computer.



The Detach Mixer icon for the Main Mixer.

For more details about the Main Mixer, please refer to “The Main Mixer” chapter.

# The Rack

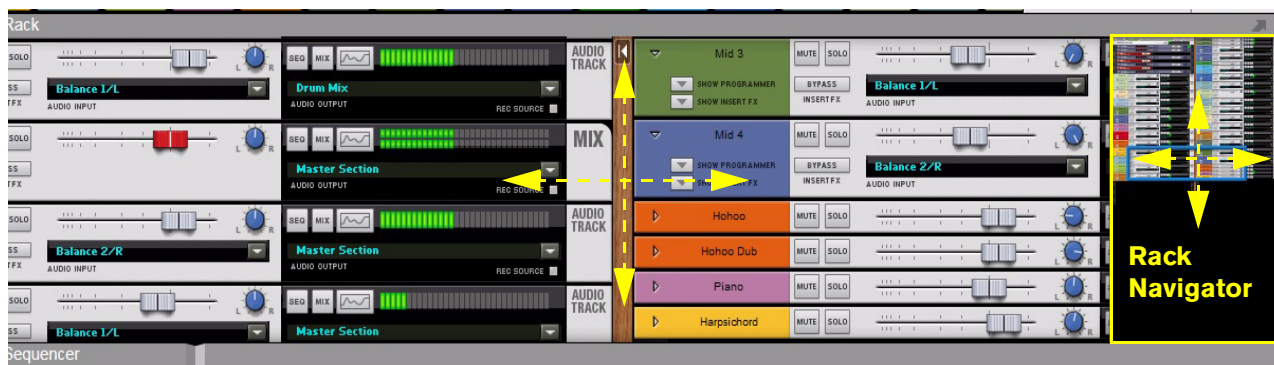

*The Rack with two rack columns next to each other, and the Rack Navigator to the right.*

In the Rack, all instruments, effects and mixer channel devices of the Reason song are visible. You can scroll vertically and horizontally in the Rack by clicking and dragging the frame in the Rack Navigator. You could also click anywhere outside the frame in the Rack Navigator to immediately jump to the desired position. Alternatively, place the pointer on any of the wooden “side panels” in the rack, and click and drag in any direction. This way you will be able to access all devices in the rack.

- **By pressing function key [F6], or by double clicking the gray Rack header, you can maximize the Rack area.**
- **To the right on the Rack header is the Detach Rack icon. Clicking this, or holding [Ctrl](Win) or [Cmd](Mac) and pressing [F6], will detach the Rack and place it in a separate window.**  
This is especially useful if you are using multiple screens with your computer.



*The Detach button for the Rack.*

When you detach the Rack, the Transport Panel at the bottom of the Sequencer will be duplicated below the Rack in the new window. This way, you will be able to control the Sequencer transport functions without needing to change window. There is also a second instance of the Browser available to the left in the detached Rack. By pressing [F3] you can toggle between Show and Hide Browser in the detached Rack.

For more details on how to work with the Rack, refer to [“Working with the Rack”](#).

# The Sequencer

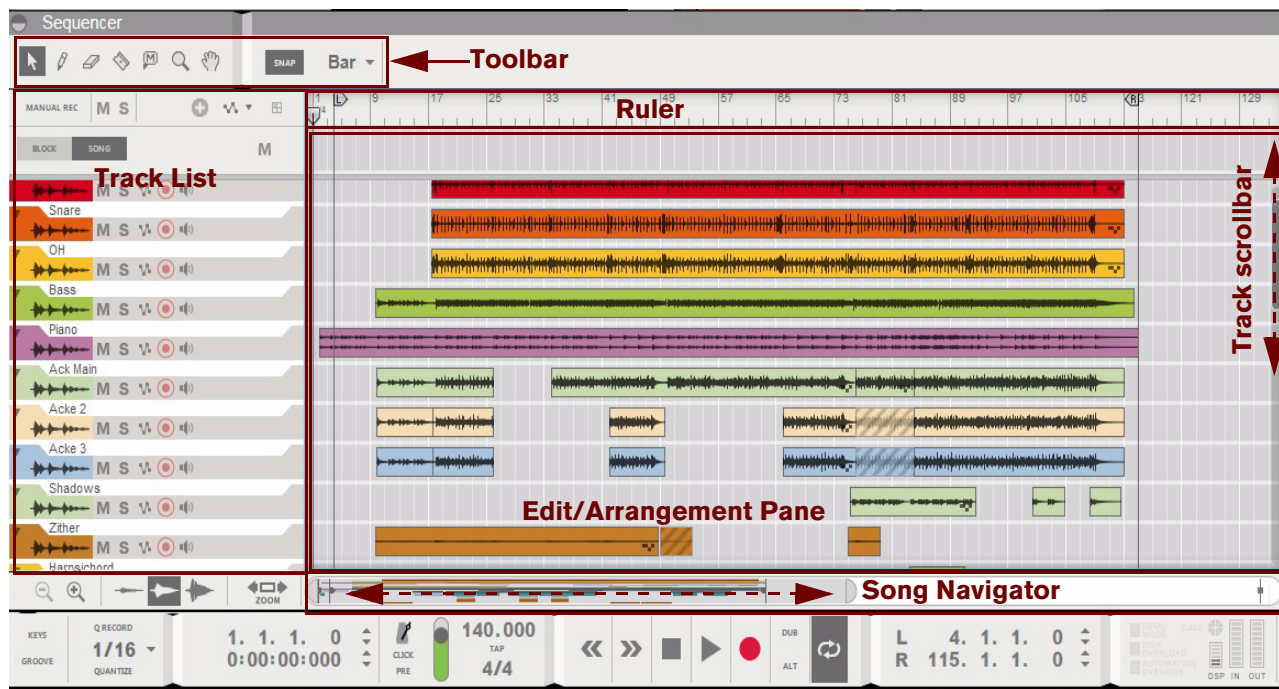

*The Sequencer with a number of recorded audio tracks.*

To the left in the Sequencer, all tracks in the Reason song are listed in the Track List. By clicking on a track in the Track List you select the track for playback from a connected MIDI master keyboard and/or for recording.

At the top to the left is the Toolbar, with various sequencer editing tools.

The big center section of the Sequencer is called the Edit/Arrangement Pane. Here is where all recorded sequencer data is displayed.

You can scroll in the Sequencer by using the Track scrollbar to the right and the Song Navigator at the bottom of the Sequencer - see [“Scrolling”](#) and [“Zooming in the Sequencer”](#).

- **By pressing function key [F7], or by double clicking the Sequencer header, you can maximize the Sequencer area.**

For more details about the sequencer, refer to [“Sequencer Functions”](#).

## The Transport Panel

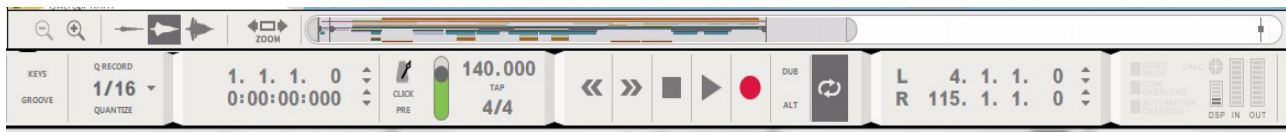

At the bottom of the Reason Song window is the sequencer Transport Panel. From here you control the sequencer transport functions, such as Rewind, Fast Forward, Stop, Play and Record. You can also set Tempo and Time Signature and various other parameters.

The Transport Panel is always available together with the Sequencer. If you have detached the Rack, a duplicate of the Transport Panel will be also present in the Rack window.

To the right on the Transport Panel are indicators for Audio In and Out levels, DSP Load, Disk Overload, Audio Calculation, Demo Mode and Automation Override status.

- **The Transport Panel can be shown/hidden from the Windows menu.**

For more details about the Transport Panel, please refer to [“Transport Panel details”](#).

## The ReGroove Mixer

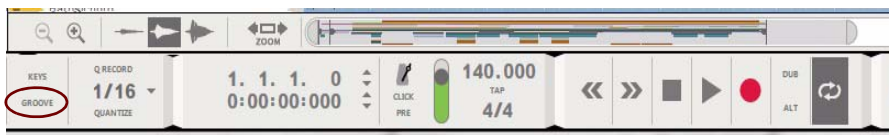

To the left on the Toolbar in the sequencer is the “Groove” button. Clicking this will bring up the ReGroove Mixer.



The ReGroove Mixer is used for adding advanced grooves to your instrument tracks in the Sequencer.

To hide the ReGroove Mixer, just click the “Groove” button again.

For more details about the ReGroove Mixer, please refer to [“The ReGroove Mixer”](#).

## Navigating between the areas

By using the functions keys [F5], [F6] and [F7] you can quickly and easily navigate between the Main Mixer, Rack and Sequencer areas of the Reason window.

- **Press [F5] to toggle between a maximized Main Mixer area and the previous view.**
- **Press [F6] to toggle between a maximized Rack area and the previous view.**
- **Press [F7] to toggle between a maximized Sequencer area and the previous view.**
- ! **If the Main Mixer and/or the Rack are detached in separate windows, you have to press [F5] to view the Main Mixer window, [F6] to view the Rack window and [F7] to view the Sequencer window. It's not possible to toggle between views/windows by repeatedly pressing the same function key.**

It's also possible to press any of the [F5], [F6] and [F7] function keys simultaneously in different combinations to switch between combined area views. For example, pressing [F5] and [F6] simultaneously will bring up a combined maximized view of the Main Mixer and Rack areas in the Reason window. The Sequencer area will then automatically become minimized

Pressing all three function keys simultaneously, or holding [Ctrl](Win) or [Cmd](Mac) and pressing [F7], will bring up all areas together, equally sized.

- ! **Note that using three function keys simultaneously is not supported on all computer keyboards.**
- ! **If the Main Mixer and/or the Rack are detached in separate windows, pressing any of the [F5], [F6] and [F7] keys in combination will automatically attach the corresponding (detached) window(s).**

To select an area for editing etc., simply click anywhere in the desired area. The selected area will then be surrounded by a thin blue rectangle.

## Showing/hiding the Navigators

Deselecting "Show Navigators" on the Options menu will hide the Channel Strip Navigator in the Main Mixer and the Rack Navigator in the rack.

Selecting "Show Navigators" will show the navigators again.

## Using several Reason Song windows

You can have several Songs open at the same time. Each Song will appear in a separate Song window, complete with Main Mixer, Rack, Sequencer and Transport Panel. Each Song window can be moved, minimized and resized using the standard Windows and Mac procedures.



# The Tool Window

The Tool Window is a floating window which features two tabs that contain functions for editing in the sequencer and for editing grooves for the ReGroove mixer. The Tool Window can be accessed from the Window menu.

- **Open the Tool Window by selecting “Show Tool Window” from the Window menu. Alternatively, press [F8].** The [F8] key can be used for toggling between showing and hiding the Tool Window.

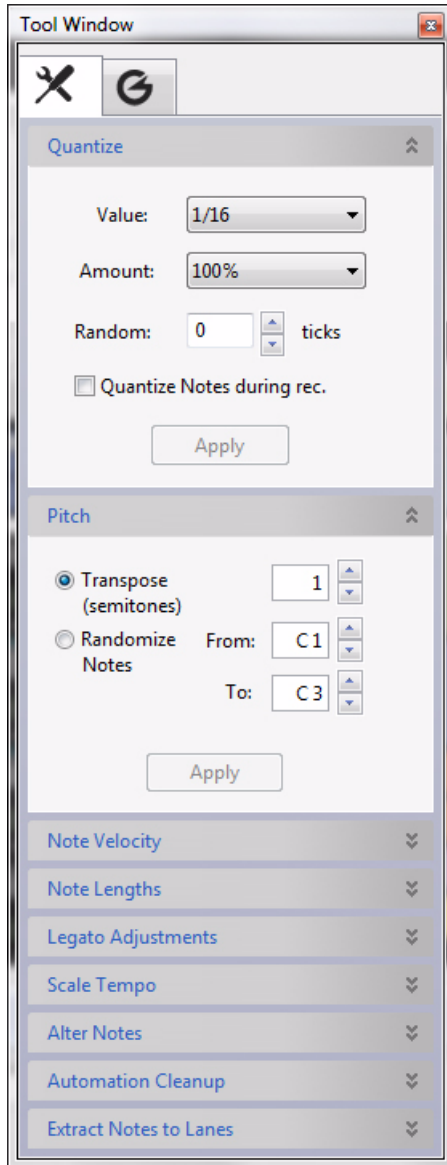

*The Tool Window.*

- See the **“Note and Automation Editing”** chapter for information on how to use the various functions of the **“Sequencer Tools”** tab.
- See **“The ReGroove Mixer”** chapter for information on how to use the functions of the **“Groove Settings”** tab.

## The On-screen Piano Keys window

The On-screen Piano Keys floating window features a virtual keyboard which lets you play instrument devices without needing to have a MIDI master keyboard connected to your computer. The On-screen Piano Keys window can be accessed from the Window menu.

- **Open the On-screen Piano Keys window by pressing [F4], or by clicking the “Keys” button to the left on the Transport Panel. Alternatively, select “Show On-screen Piano Keys” from the Window menu.**

The [F4] key can be used for toggling between showing and hiding the On-screen Piano Keys window.

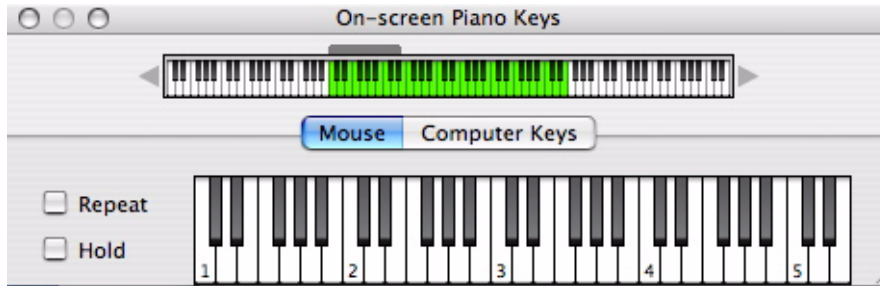

*The On-screen Piano Keys window in “Mouse” mode.*

See [“On-screen Piano Keys”](#) for more information.

# General window techniques

## Resizing



*Adjustable headers in the Reason Song window.*

Between each area in the Reason Song window are gray headers that separate the areas from each other. Some of the headers can be adjusted, making it possible to resize the areas. The horizontal dividers between the Main Mixer and Rack, and between the Rack and Sequencer can be adjusted, as well as the vertical dividers between the Browser and the other areas - and the divider to the left of the Rack Navigator in the Rack.

When you place the mouse pointer on these types of headers, the pointer changes to a double-arrow symbol. Clicking and dragging these headers makes it possible to resize the adjacent areas.

→ You can also click the circular button on the header of any of the areas to show/hide the corresponding area:

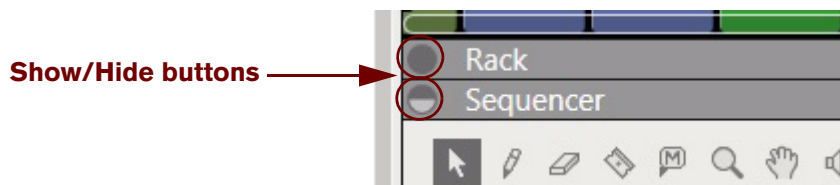

*The Show/Hide buttons of the Rack and Sequencer areas.*

# Scrolling

Reason offers a few different options for scrolling in the different areas.

## Scrolling with the Navigators and scrollbars



*Navigators/scrollbars in a Reason Song window.*

Whenever there is information “outside” the visible screen area, you may want to scroll to the desired destination. The Reason Song window features a number of Navigators that can be used for scrolling. Navigators are present in the Main Mixer, in the Rack and in the Sequencer.

The Main Mixer and the Sequencer have horizontal and vertical Navigators/scrollbars.

The Rack has only one Navigator which can be used for scrolling both vertically and horizontally (when using more than two rack columns next to each other). The Rack Navigator can also be resized by moving the vertical edge to the left of the Rack Navigator. Resizing the Rack Navigator will also resize the rack devices inside the Navigator, making them easier to distinguish.

- **To scroll with a Navigator, click anywhere inside the frame in the Navigator and drag the frame to the desired position.**  
As the pointer enters the frame, it automatically switches to a hand symbol.
- **Alternatively, click anywhere in the Navigator area to immediately jump to the desired position.**
- **At high zoom values in the Sequencer, you can hold [Shift] and drag the Song Navigator frame to scroll with greater precision.**

## Scrolling with the Hand tool

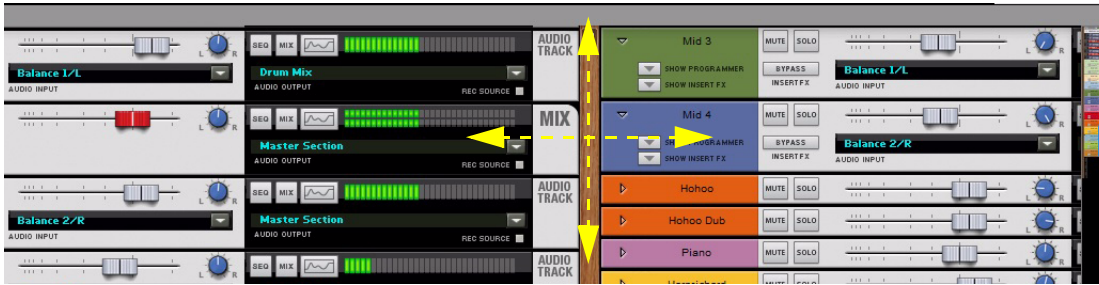

*Scrolling with the Hand tool in the Rack.*

In the Rack and Sequencer, you can also use the Hand tool for scrolling the view.

- 1. In the Rack, place the pointer on either of the wooden side panels of a rack column.**  
The pointer will switch to a hand symbol.
- 2. Click and drag the rack vertically and/or horizontally to scroll in the rack, as shown in the picture above.**  
If you are using only a single rack column, it's only possible to scroll vertically.

In the Sequencer you have to manually switch to the Hand Tool by selecting it from the sequencer Toolbar. With the Hand Tool selected, you can scroll in any direction on the Edit/Arrangement Pane. Refer to [“Hand Tool”](#) for more information.

## Zooming in the Sequencer

In the Sequencer it's possible to zoom in and out horizontally using the Song Navigator. You can also use the Magnifying Glass Tool on the Sequencer Toolbar to zoom vertically - see [“Magnifying Glass Tool”](#). In addition to this, it's also possible to set a zoom level for the audio recordings inside the Audio Clips.

➤ See also [“Scrolling and zooming using a wheel mouse”](#).

### Zooming vertically in the Sequencer

- ➔ To zoom in vertically in the Sequencer arrangement, and thus increase the Track height, click on the “+” magnification button at the bottom of the Track List:

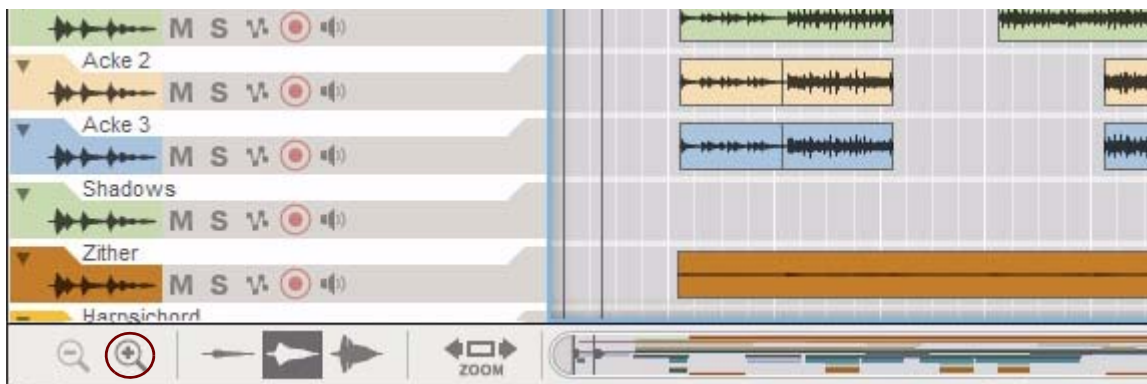

*Increase the Track height by clicking the + magnification button at the bottom of the Track List.*

- ➔ To zoom out vertically, click on the “-” magnification button.
- When the Sequencer is in Edit Mode, individual vertical zoom controls become available.

## Waveform Zoom Mode



- **Choose between three zoom modes for the audio recording(s) inside all Audio Clips.**

Using the Small Waveform Zoom Mode is especially useful if you have recorded with the Clip Safe function (see ["Recording using the Clip Safe function in Propellerhead Balance"](#)) where the dynamic range can be quite wide.

- ! **The zoom modes only affect the visual presentation of the waveform, not the audio levels.**

## Zooming horizontally in the Sequencer

You can also zoom in and out horizontally in the Sequencer by using the Song Navigator.



- **To zoom in and out horizontally, click and drag a Song Navigator handle sideways.**  
The pointer changes to a double arrow symbol and you can now zoom in by resizing the Song Navigator Frame.
- **[Shift]-click on a Song Navigator handle and drag horizontally to zoom in and out symmetrically.**
- **By right-clicking (Win) or [Ctrl]-clicking (Mac) inside the Song Navigator frame you can both scroll (drag sideways) and zoom (drag up or down) simultaneously.**

## Zooming to selection



- **Click the Zoom To Selection button or press [Z] to do one of two things:**  
Zoom horizontally to fit the current selection (e.g. selected clips in the arrangement).  
Zoom out horizontally to "Show All".

"Show All" happens if there is no selection, or if you are already zoomed in on the current selection (i.e. you can press Z repeatedly and go between zoomed in and zoomed out).

"Show All" means different things depending on the mode:

- **If you're in Song mode, Show All = from the first clip to the last in song.**
- **If you're in Edit mode (with no open clip), Show All = all clips on this track.**
- **If you're in an open clip, Show All = see the whole clip.**

## Scrolling and zooming using a wheel mouse

If you're using a mouse equipped with a scroll wheel, this can be used for the following scrolling and zooming operations:

### Scrolling in the Main Mixer with a wheel mouse

- **Spin the scroll wheel to scroll vertically in the Main Mixer.**
- **Press [Shift] and spin the scroll wheel to scroll horizontally in the Main Mixer.**

### Scrolling in the Rack with a wheel mouse

- **Spin the scroll wheel to scroll vertically in the Rack.**

- **Press [Shift] and spin the scroll wheel to scroll horizontally in the Rack.**

Note that the Rack must have at least two rack columns next to each other for this to work.

## Scrolling in the Sequencer with a wheel mouse

- **Spin the scroll wheel to scroll vertically on the Edit/Arrangement Pane.**
- **Press [Shift] and spin the scroll wheel to scroll horizontally on the Edit/Arrangement Pane.**
- ! **Note that scrolling horizontally cannot be done when the Song Navigator frame is fully expanded.**

## Zooming in the Sequencer with a wheel mouse

- **Press [Ctrl](Win) or [Cmd](Mac) and spin the scroll wheel to zoom in and out vertically on the Edit/Arrangement Pane.**
- **Press [Ctrl]+[Shift](Win) or [Cmd]+[Shift](Mac) and spin the scroll wheel to zoom in and out horizontally on the Edit/Arrangement Pane.**

# Editing parameters

Since a large part of Reason is laid out like “real” hardware devices, such as the Main Mixer, instrument and effect devices etc., almost all controls are designed like their real world counterparts - mixer faders, effect unit knobs, transport buttons, etc. How to adjust these controls is described in the following paragraphs.

## Knobs

- **To “turn” a knob, point at it, hold down the mouse button and drag up or down (as if the knob was a vertical slider).**

Dragging upwards turns the knob clockwise and vice versa.



- **If you press [Shift] and drag, the knob will turn slower, allowing for higher precision.**  
You can also adjust the knob precision with the “Mouse Knob Range” setting on the General page in Preferences. This dialog is opened from the Edit menu (or from the Reason menu if you are running Mac OS X).
- **To reset a knob to its default value (usually zero, center pan or similar), press [Ctrl](Win) or [Cmd](Mac) and click on the knob.**

## Faders and sliders

→ To move a fader or slider, click on the handle and drag in the fader/slider direction.



- You can also click anywhere on the fader/slider to instantly move the handle to that position.
- If you press [Shift] and drag, the fader/slider will move more slowly, allowing for higher precision.
- To reset a fader/slider to its default value (usually zero, 100, center pan or similar), press [Ctrl](Win) or [Cmd](Mac) and click on the fader/slider handle.

## Buttons



Many functions and modes are controlled by clicking buttons. Many of the buttons in Reason have a “built-in” LED, or the button itself lights up, indicating whether the button is on or not.



## Fold/Unfold buttons

Fold/Unfold buttons are distinguished by a small triangle at the top to the left on a device. Clicking on a Fold/Unfold button will unfold the device panel so that more controls are visible and can be accessed for editing on the screen.

On some devices, such as the RV7000 Advanced Reverb, there are more than one Fold/Unfold button. Clicking on the second Fold/Unfold button on the unfolded front panel will open up the Remote Programmer panel from which more parameters can be accessed:



*Click on the Fold/Unfold Button to unfold the front panel.*



*Click on the second Fold/Unfold Button on the unfolded panel to bring up the Remote Programmer.*



*The Fold/Unfold buttons on an RV7000 Advanced Reverb device.*

## Multi Mode selectors

Some parameters allow you to select one of several modes. There are two different graphical representations of this in Reason.

The multi mode selector type below consists of a button with the different modes listed above it:



→ **Click the button to step through the modes or click directly on one of the modes printed on the panel, or click on the corresponding LED, to select mode.**

The currently selected mode is indicated by a lit LED.

The multi mode selector type below is a switch with more than two positions:



→ **To change mode, click and drag the switch, or click directly at the desired switch position (just as when adjusting a slider).**

## Numerical controls

In Reason devices, numerical values are often displayed in numerical displays with “spin controls” (up/down arrow buttons) on the side. Some parameter values, such as oscillator and LFO waveforms, are displayed graphically in the displays. There are two ways of changing values in these types of controls:

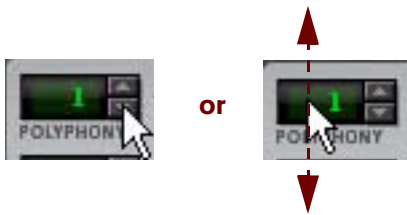

- **By using the up and down buttons on the spin controls.**  
To adjust a value in single steps, click on its up or down arrow button. To scroll a value continuously, click on an arrow button and keep the mouse button depressed.
- **By clicking and holding the mouse button depressed in the actual display and then dragging the mouse up or down.**  
This allows you to make coarse adjustments very quickly.

## Alpha-numeric controls

In Reason, alpha-numeric values and/or device presets are displayed in alpha-numeric readouts with “spin controls” (up/down arrow buttons) on the side. There are two ways to change alpha-numeric/preset values:



- **By using the up and down buttons on the spin controls.**  
To adjust a value or select a preset in single steps, click on the up or down arrow button. To scroll a value continuously, click on an arrow button and keep the mouse button depressed.
- **By clicking and holding the mouse button depressed in the actual alpha-numeric display and selecting from the list that appears.**  
This allows you to make coarse adjustments very quickly or to immediately change to a preset anywhere in the list.
- **This type of control is used to select, e.g., patch and reverb algorithms and some oscillator waveforms.**

## Numerical segment displays

In the numerical segment displays on the sequencer Transport Panel and in the sequencer Inspector, values can be edited in a number of different ways. The editing principle is exactly the same for the Transport Panel and Inspector displays, which is shown in the two examples below.

### Transport Panel segment displays

The segment displays of the Transport Panel can be edited as shown in the following Tempo display examples. The Tempo display segments show (from left to right) BPM and 1/1000 BPM:

*Click on the left display segment to select the “whole BPM” value. Then, either click and drag up or down or use the mouse scrollwheel to change tempo in steps of 1 BPM. You can also use the [Up]/[Down] arrow keys on the computer keyboard to change the value.*

*Alternatively, type in the new tempo and press [Enter] on the computer keyboard.*

*You can also type in a number preceded by [+] or [-] to add or subtract the number from the current tempo value. Then, press [Enter] on the computer keyboard.*

*Click on the right display segment to select the “1/1000 BPM” value. Then, either click and drag up or down or use the mouse scrollwheel to change tempo in steps of 1/1000 BPM. You can also use the [Up]/[Down] arrow keys on the computer keyboard to change the value.*

*Alternatively, type in the new tempo and press [Enter] on the computer keyboard.*

*You can also type in a number preceded by [+] or [-] to add or subtract the number from the current tempo value. Then, press [Enter] on the computer keyboard.*

*Double-click on the display, type in the new tempo and press [Enter] on the computer keyboard.*

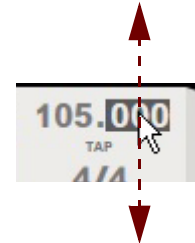

The other segment displays on the Transport Panel can be edited in the same way as described above. Some displays also features up/down arrow buttons.

## Inspector segment displays

The segment displays in the Inspector can be edited as shown in the following Position display examples. The Position display segments show (from left to right) Bars, Beats, 1/16th Note and Ticks:

*Click the up/down buttons to change the value in steps of 1 Bar (the leftmost segment).*



*Click in the display to select either the Bar, Beat, 1/16th note or Ticks segment. Then, click the up/down buttons to change the value of the selected segment in steps of 1 unit.*



*Click in the display to select either Bar, Beat, 1/16th note or Ticks. Then, click and drag the cursor up/down to change in steps of 1 unit. Alternatively, change the value with the mouse scrollwheel. You can also use the [Up]/[Down] arrow keys on the computer keyboard.*



*Click in the display to select either Bar, Beat, 1/16th note or Ticks. Then, type in a number and press [Enter].*



*Alternatively, select a segment, type in a number preceded by a [+] to add or a [-] to subtract the number from the current value. Then, press [Enter].*

*Double-click in the display. Then, type in the desired value and press [Enter].*

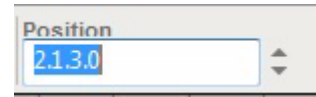

The other segment displays in the sequencer Inspector can be edited in the same way as described above.

## Tool Tips

If you hover with the mouse over a control on a device panel and wait a moment, a tool tip appears. The tool tip shows the name of the parameter associated with that control and its current value. This helps you fine-tune settings, set several parameters to the same value, etc.



→ You can turn off the Tool Tips function by deactivating the option “Show parameter value tool tip” in the “Appearance” section on the General page in Preferences.

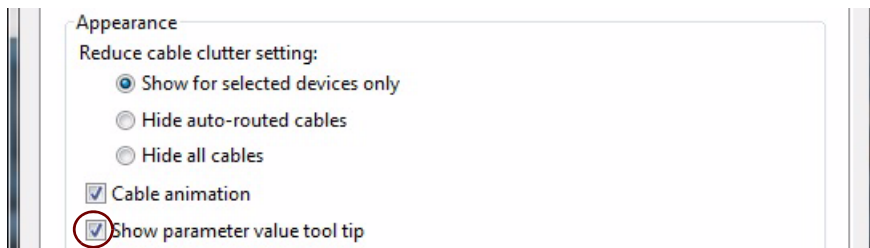

# Context menus

Context menus are “tailored” to contain only menu items that are relevant to the current circumstances. Using the various context menus allows you to work more quickly and more efficiently with Reason.

→ **To bring up a context menu, right-click (Win) or [Ctrl]-click (Mac) on the desired object, section or area in Reason.**

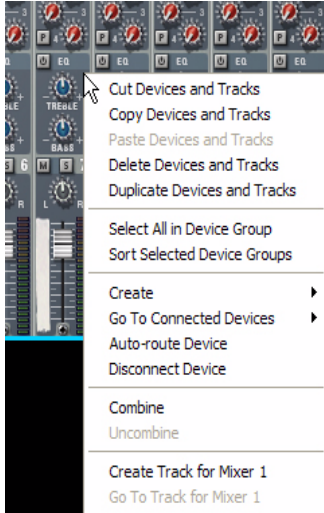

*The Mixer 14:2 device panel context menu*

→ **If you are using a Mac with a two button mouse, you may want to set this up so that clicking the right mouse button generates a [Ctrl]-click. This way, you can right-click to bring up context menus.**

The contents of the context menus depend on where you click. These are the primary types of context menus you will encounter in Reason:

## Parameter context menus

If you click on an automatable control (a mixer parameter, a device parameter, a fader, etc.), the context menu will contain the following items:

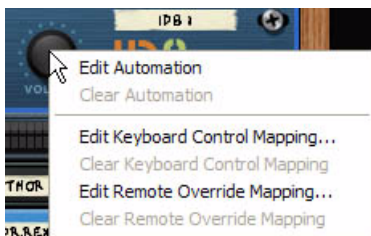

- **Functions for editing and clearing the recorded automation data for the control.**
- **Functions for associating computer keyboard commands and/or MIDI messages to the parameter.**  
This allows you to remote control parameters from a MIDI device or from the computer keyboard.

## Device context menus

If you click anywhere on a device in the Rack (but not on a parameter or display), the context menu will contain the following items:

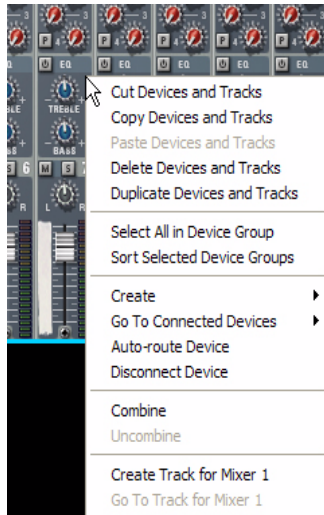

*The Mixer 14:2 device panel context menu*

- **Cut, Copy, Paste, Delete and Duplicate Device and Track items, allowing you to rearrange and manage the devices in the rack.**
- **Commands for managing Device Groups.**
- **A duplicate of the Create menu, allowing you to create new devices.**
- **A “Go To” submenu, listing all devices connected to the current device.**  
Selecting a device from the Go To submenu scrolls the rack to bring that device into view.
- **Auto-routing and Disconnect functions.**  
This allows you to automatically route (connect) or disconnect a selected device in a logical way.
- **Combine and Uncombine are used when you want to use the selected device in, or exclude it from, a Combinator setup.**
- **A Browse Instruments item which lets you browse for sounds for a selected Instrument device.**  
This item is available only for Instrument devices.
- **Additional device-specific items.**  
If the device is pattern-based, there will be various pattern functions (Cut/Copy/Paste, Clear, Shift, Randomize, etc.). These affect the currently selected pattern in the device.  
If the device uses patches, there will be functions for managing patches.  
Depending on the device there may also be various device-specific functions available. For example, the drum machine device has functions for manipulating the pattern for the selected drum sound only, etc.
- **“Create Track for...” and “Delete Track for...” are used if you want to create a Sequencer Track for the selected device, or delete the Sequencer Track used for the device without deleting the actual device.**
- **The “Go To Track for ...” will scroll the corresponding Sequencer Track into view in the Sequencer.**
- **The “Lock Control Surface to this Device” lets you lock a connected control surface to the selected device.**
- **The “Track Color” item lets you select color for the associated Sequencer Track (and Main Mixer channel strip, if the selected device is an Audio Track device).**

## Main Mixer channel strip context menu

If you click anywhere on a channel strip in the Main Mixer (but not on a parameter or display), the context menu will contain the following items:

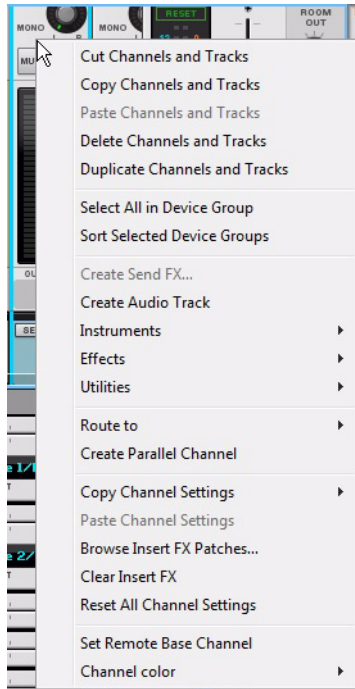

*The Channel Strip context menu.*

- **Cut, Copy, Paste, Delete and Duplicate Channels and Track items, allowing you to rearrange and manage the channel strips in the Main Mixer.**
- **Commands for managing Device Groups.**
- **The “Create Send FX” lets you browse for an effects device, or Effect Combi patch, to connect and use as a send effect.**  
The send effect will be automatically connected to the first available Send FX connectors of the Master Section device in the Rack.
- **A duplicate of the Create menu, allowing you to create new devices.**
- **“Route to” lets you create and connect to an Output Bus for sub-mixing.**
- **“Create Parallel Channel lets you create and connect to an additional channel for parallel processing.**
- **The “Copy Channel Settings” item lets you copy groups of settings for the selected channel strip.**  
The groups that can be selected are: “Dynamics”, “Filters and EQ”, “Insert FX”, “FX Sends” and “All”.
- **The “Paste Channel Settings” item appears if you have previously copied any channel settings and want to paste these to the selected channel strip.**
- **The “Browse Insert FX Patches” lets you browse for, and load, Effect Combi patches to the Insert FX section.**
- **The “Clear Insert FX” lets you delete any Insert Effects devices used in the channel.**
- **The “Reset All Channel Settings” resets all channel strip parameters to their default values.**  
It also automatically removes any used Insert FX devices from the channel strip.
- **The “Set Remote Base Channel” item lets you set the remote base channel to the selected channel strip.**  
This is useful when you remote control channel strips from a control surface via MIDI.

- The “**Lock Control Surface to this Device**” lets you lock a connected control surface to the selected channel strip.
- The “**Channel Color**” item lets you select color for the Main Mixer channel strip (and the associated Sequencer Track, if the selected channel has a track in the sequencer).

## Rack “background” context menu

If you click in an empty area of the rack, the context menu will contain the following items:

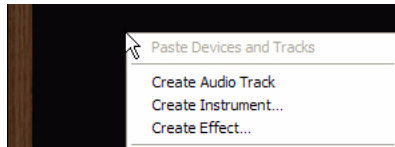

- A **Paste Devices and Tracks** item, allowing you to paste any copied or cut devices and tracks.
- A duplicate of the **Create** menu, allowing you to create new devices.

## Main Mixer “background” context menu

If you click in an empty area of the Main Mixer, the context menu will contain the following items:

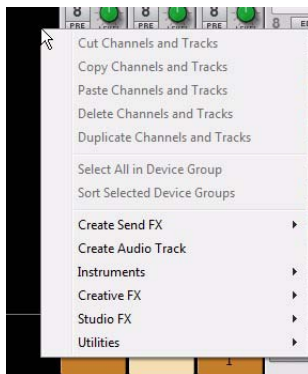

- A duplicate of the **Create** menu, allowing you to create new devices.
- The “**Create Send FX**” lets you browse for an effects device, or **Effect Combi patch**, to connect and use as a **send effect**.

The send effect will be automatically connected to the first available Send FX connectors of the Master Section device in the Rack.

## Sequencer context menus

If you click in the Sequencer, the context menus will contain items related to editing tracks, clips and events. The available items will differ depending on in which section or lane you click (Track List, note lane, etc.), and depending on whether you click on a note or automation event or not.

For example, the sequencer context menus contain functions for inserting or removing bars, deleting tracks, changing or deleting note and automation events.



# Undo and Redo

Virtually all actions in Reason can be undone. This includes creation, deletion and reordering of devices in the rack, parameter value adjustments, recording and editing in the sequencer etc. You can undo hundreds of actions.

- **To undo the latest action, select “Undo” from the Edit menu, or hold down [Ctrl](Win) or [Cmd](Mac) and press [Z].**

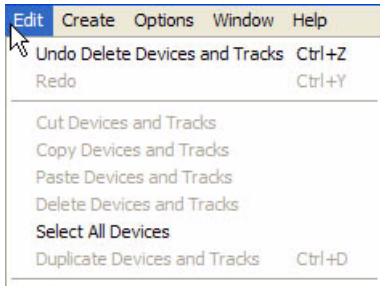

The action to be undone is indicated next to the Undo command on the Edit menu. For example, if your latest action was to delete some device(s) from the rack, the Edit menu will display “Undo Delete Devices and Tracks”.

- **To redo the last undone action (“undo the undo operation”), select “Redo” from the Edit menu, or hold down [Ctrl](Win) or [Cmd](Mac) and press [Y].**

Similarly, the action to be redone is shown on the Edit menu.

## About multiple Undos and Redos

The concept of multiple undos may require an explanation.

Let's say you have performed the following actions:

- 1. Created a Mixer device.**
- 2. Created a synth device.**
- 3. Adjusted the Attack parameter of the synth device.**
- 4. Changed the panning for the synth device in the Mixer.**
- 5. Adjusted the playback tempo on the Transport Panel.**

After these five actions, the Undo History will look as follows:

UNDO
5. Adjust tempo
4. Change pan
3. Adjust Attack
2. Create Synth Device
1. Create Mixer Device

If you now select Undo, your latest action (the tempo change) will be undone, and moved to a “Redo list”:

UNDO	REDO
4. Change pan	
3. Adjust Attack	
2. Create Synth Device	
1. Create Mixer Device	5. Adjust tempo

Selecting Undo again undoes the next action in the list (the panning adjustment):

UNDO	REDO
3. Adjust Attack	
2. Create Synth Device	4. Change pan
1. Create Mixer Device	5. Adjust tempo

If you now select Redo, the most recently undone action will be redone. In this case, your panning adjustment will be performed again (and added to the Undo History again):

UNDO	REDO
4. Change pan	
3. Adjust Attack	
2. Create Synth Device	
1. Create Mixer Device	5. Adjust tempo

At this point, you still have the option to Redo the tempo change. But if you instead perform another action (e.g. change the level of the synth device in the mixer), this would become the action at the top of the Undo History - and the Redo list would be cleared.

UNDO	REDO
5. Change level	
4. Change pan	
3. Adjust Attack	
2. Create Synth Device	
1. Create Mixer Device	(Empty)

You can no longer redo the “undone” tempo change!

# **Chapter 3**

## **On-screen Piano Keys**

# About this chapter

This chapter describes the functions of the On-screen Piano Keys window.

The On-screen Piano Keys window enables you to play instrument devices using either your mouse or computer keyboard. This provides a simple and convenient way to input notes or chords when using the program without an attached MIDI master keyboard.

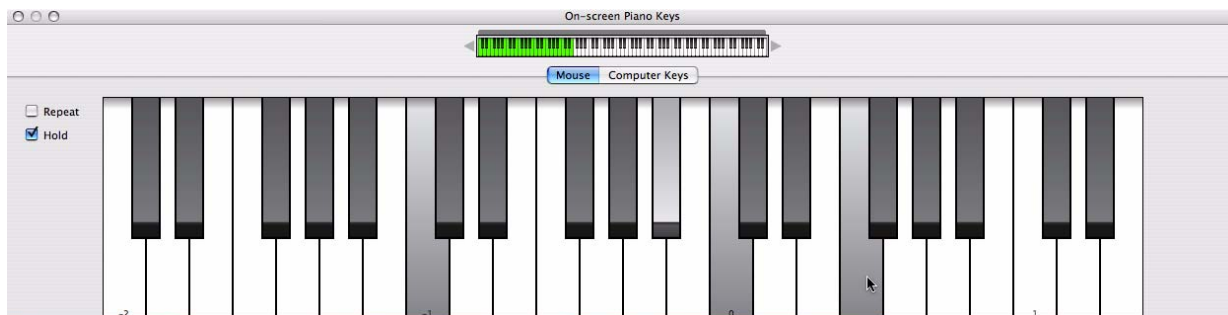

## Using the On-screen Piano Keys

### Opening the Piano Keys window

- To open the window, press [F4] or select “Show On-screen Piano Keys” from the Windows menu - or click the Keys button to the left on the sequencer Transport Panel.

Like the Tool window, the On-Screen Piano Key window “floats” on top of other windows, remaining visible most of the time.

- You can choose between two basic operational modes to enter notes; “Mouse” or “Computer Keys”. Mouse Mode is for entering notes with the mouse, and Computer Keys Mode for using the computer keyboard to enter notes. The two modes are described separately below.

The respective buttons in the middle of the window are used to switch modes.



*Mode buttons.*

- **Regardless of mode, the On-screen Piano Keys window always follows Master Keyboard input.** This means that the Piano Keys will trigger the device associated with the track that has Master Keyboard Input. The Piano Keys input is merged with any attached keyboard/control surface input so you can use both simultaneously.
- **The available note range is 10 octaves (C -2 to E 8).**
- **When the On-screen Piano Keys window is in Mouse mode, you can resize it by clicking and dragging the window frame according to standard procedures.** This is especially useful in “Mouse” mode, since you can adapt the window to show the desired note range.

## The Keyboard Navigator

This is present in both modes and shows the total key range. The green area indicates the key range available in the On-screen Piano Keys window.

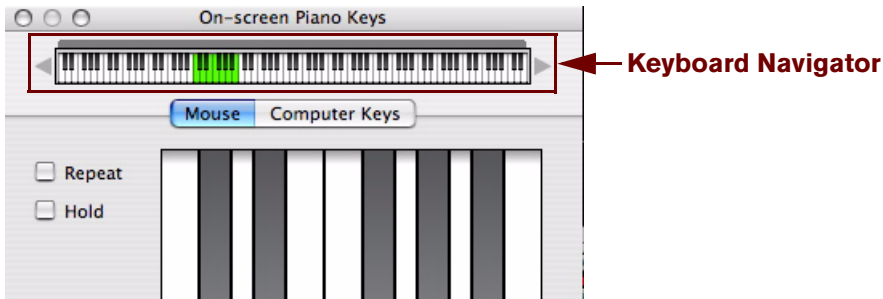

Keys that produce sound are indicated by a gray strip above the keyboard in the Keyboard Navigator. This is useful when playing a patch where only certain keys or key ranges produce sound, e.g. a REX file or a sampler patch.

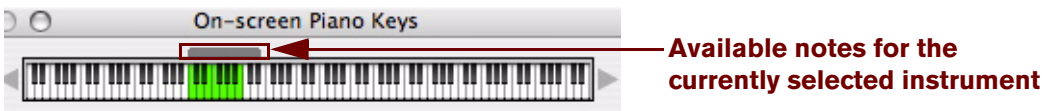

## Setting Octave range

There are several ways to set the Octave range:

- **Click the arrow buttons on either side of the Keyboard Navigator.**  
Each click will shift one octave up or down.

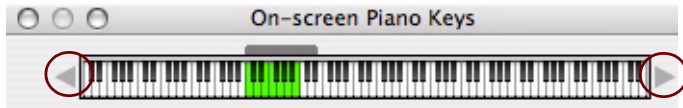

- **Click and drag the green key range area in the Keyboard Navigator.**

The current octave number is always shown for the leftmost key - by default the [A] key on the computer keyboard.

## Mouse mode

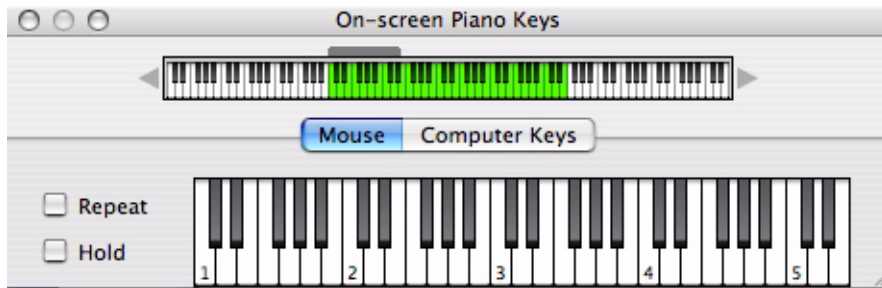

When Mouse Mode is selected, the Piano Keys window will show a standard piano keyboard.

- **To enter notes, simply click on the keyboard with your mouse.**  
As described above, the record enabled track governs what instrument device is played.

- **The keys are velocity sensitive. The higher up on the key you click, the lower the velocity and vice versa.**  
The velocity range is between 40 and 127.



*Low and high note velocities.*

- **The keyboard octave range can be set using the arrow buttons at each side of the navigator keyboard.**  
Each C key is labeled with the octave number. You can also simply drag the green key range area to where you want. It will snap to octave ranges.
- **In Mouse Mode, the keyboard can be resized both vertically and horizontally.**  
Resizing horizontally extends or diminishes the key range. By resizing the window vertically you change the key size for the keyboard, as well as the key range.

## Adding sustain

If you press [Shift] when entering notes, the notes will sustain, just like when using a sustain pedal.

## Repeat and Hold functions

- **The Repeat function will continuously repeat the last clicked note as quarter notes with a quarter note pause in between (at the current tempo).**  
This feature can be useful when tweaking synth parameters or browsing for patches. It is activated/deactivated by checking/unchecking the box.
- **The Hold function will keep any keys you click on pressed down for as long as Hold is active.**  
Hold is activated/deactivated by checking/unchecking the box.

## Computer Keys mode

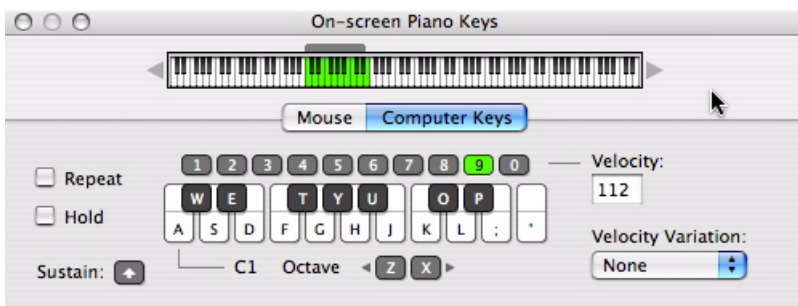

When Computer Keys Mode is selected, the On-screen Piano Keys window shows a graphic (partial) representation of a computer keyboard. The window cannot be resized in this mode.

→ **In Computer Keys Mode you can play notes and chords using your computer keyboard.**

The Computer Keys keyboard range is fixed to 18 notes (from C to F), although the octave range will give you access to any notes within the ten octaves shown in the navigator. You can also click on the keys with your mouse to trigger notes. The numerical keys in the top row are not used to enter notes but to set velocity, see “Velocity”.

→ **The default layout of the Computer Keys logically reflects the layout of a piano keyboard’s black and white keys.**

The first (leftmost) key represents C and so on up to F an octave above. By default, the [A]-key will play the first C, the [W]-key a C# and so on, according to piano keyboard standards. If you wish, you can customize the note to key assignment in the Preferences - Advanced page (see “Preferences – Advanced”).

## Octave range

→ **Press [Z] or [X] on your computer keyboard to shift one octave down or up, respectively.**

There are also “Z” and “X” Octave buttons in the On-screen Piano Keys window that function in the same way.

See “Setting Octave range” for more ways of changing the Octave range.

## Repeat and Hold functions

See “Repeat and Hold functions”.

## Adding sustain

→ **Press [Shift] when entering notes to make the notes sustain, just like when using a sustain pedal.**

There is also a Sustain button in the On-screen Piano Keys window that has the same functionality.

## Velocity

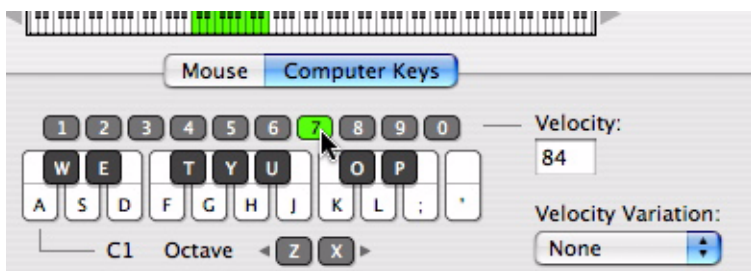

In Computer Keys Mode, note velocity for notes you enter is set using the numerical keys in the top row. The currently set value is also shown in the Velocity value field. The numerical keys correspond to the following velocity values:

Numerical key	Velocity value
1	1
2	14
3	28
4	42
5	56
6	70
7	84
8	98 (default)
9	112
0	127

## Velocity Variation

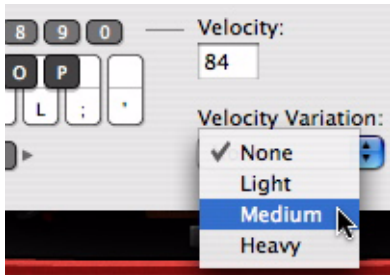

This feature will randomly vary the velocity values for the notes you enter. There are four modes; None (default), Light, Medium and Heavy. The degree of velocity variation is as follows.

Item	Variation
None (default)	0
Light	+/- 5%
Medium	+/- 10%
Heavy	+/- 25%



# **Chapter 4**

## **Audio Basics**

# About this chapter

This chapter contains some useful information about how audio is handled by Reason and how the audio is routed. Some of it may seem a bit technical, but we recommend that you read it to get the most out of Reason.

## How Reason communicates with your audio hardware

Reason receives, generates and plays back digital audio - a stream of numerical values in the form of ones and zeroes. For you to be able to record and play back anything, the audio must be converted from analog to digital when recording, and from digital to analog when playing back through some kind of listening equipment (a set of speakers, headphones, etc.).

This conversion is most often handled by the audio card installed in your computer, or by an external audio interface connected via USB or FireWire. To achieve the best possible performance, Reason requires that the audio card uses an ASIO driver on Windows systems. On Mac OS X systems, Reason supports Core Audio drivers.

To receive and deliver digital audio to the computer's audio hardware, Reason uses the driver you have selected in the Preferences dialog. In the Rack on screen, this connection is represented by the Hardware Interface (also known as the Hardware Device):

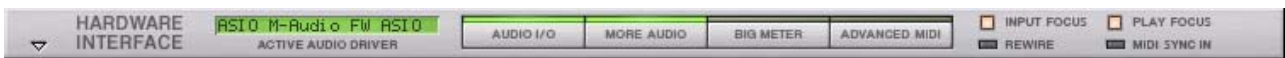

*The Hardware Interface is always located at the top of the rack.*

**! If you are using Reason as a ReWire slave, Reason will instead feed the digital audio to the ReWire master application (typically another audio sequencer program), which in turn handles the communication with the audio hardware. See “ReWire” for more details.**

The Hardware Interface contains 64 input and 64 output “sockets”, each with an indicator and a level meter. There are also two Sampling Inputs that can be used for sampling audio to sampler devices. 16 input and 16 output sockets are shown on the main panel, and an additional 48+48 sockets are shown if the “More Audio” button is activated on the main panel. Each one of these indicators represents a connection to an input or output on your hardware audio interface (or a ReWire channel to another application if you are using ReWire).

However, the number of available inputs and outputs depends on the number of inputs and outputs on your hardware audio interface. For example, if you are using a standard sound card with stereo inputs and outputs, only the first two inputs and outputs will be available. In the Hardware Interface, the indicators are lit green for all currently active and connected inputs and outputs. Activation of inputs and outputs on your hardware audio interface is done on the Audio page in the Preferences dialog (see “Active input and output channels”).

Inputs and outputs that are currently connected have green indicators. Available but un-connected inputs and outputs have yellow indicators and any connections made to unavailable inputs and outputs have red indicators.



*In this case, Inputs 1 and 2 are available, but not connected, Outputs 1 and 2 are available and connected, whereas Output 3 is unavailable, but connected on the back of the Hardware Interface.*

**! You never have to connect any cables to the Audio In jacks of the Hardware Interface to be able to record audio on sequencer tracks. This routing is made internally “in the background”, which means you just have to select audio interface inputs from the Audio Input drop-down list - see “Selecting audio input(s) and defining mono or stereo”.**

## Manual audio routing

In most cases, you will want to have the Main Mixer Master Section device connected to outputs 1 and 2 of the Hardware Interface. This connection is made automatically as soon as you create a new Song document. However, there might be situations where you want to manually route audio to other outputs of the Hardware Interface. For example if you want to use the Control Room Outputs of the Main Mixer (see “Control Room output section”).

To send the sound of a device in the Rack to a specific output, you route the device output to the corresponding Output jack on the Hardware Interface. This is done by using the patch cables on the back of the rack, as described in “Manual routing”. If we flip the rack around, by pressing the [Tab] key, the Hardware Interface looks like this:



*On the rear of the Hardware Interface, Inputs 1 and 2 are available but not connected, Outputs 1 and 2 are available and connected, whereas Output 3 is connected but unavailable.*

! **You never have to connect any cables to the Audio In jacks of the Hardware Interface to be able to record audio on sequencer tracks. This routing is made internally “in the background”, which means you just have to select audio interface inputs from the Audio Input drop-down list in the sequencer Track List - see “Selecting audio input(s) and defining mono or stereo”.**

## Audio quality

The audio quality in a computer based recording system depends on two things:

- **The quality of the software calculating the audio.**  
In our case, this is the Reason DSP (Digital Signal Processing) code.
- **The quality of the hardware audio interface used for recording and playing back the sound.**

### Software

- **Reason uses 32-bit floating point arithmetic for all internal audio operations, with 64-bit summing in the mix bus in the Main Mixer Master Section.**  
This ensures the highest possible audio quality throughout the entire signal chain.
- **Reason supports 16, 20, and 24 bit resolution for input and output audio.**
- **Reason supports all standard sample rates between 44.1 kHz and 192 kHz.**  
Reason also supports lower sampling frequencies, but using a sample rate of less than 44.1 kHz is not recommended since it might affect the audio quality negatively.
- **A number of digital audio techniques that reduce the risk of “aliasing”, background noise, unwanted distortion and “zipper noise” are implemented in Reason.**

### Audio hardware

How good a hardware audio interface actually sounds depends on a number of things; its frequency range and frequency response curve, the resolution (bit depth), the signal to noise ratio, the distortion under various circumstances, etc. Furthermore, some designs are more prone to disturbance from the other electronics in the computer than others. Such disturbance might add hum or high pitched noise to the signal.

The only advice we can give is that if you are serious about sound, choose your audio hardware carefully!

# Audio settings

Sample rate and resolution are properties of digital audio which determine the quality of the sound. Generally, higher sample rate and resolution result in better audio quality (but also larger audio files and higher demands on computer performance and audio hardware). The table below shows some common sample rate/resolution combinations:

Sample rate:	Resolution:	Comment:
44.1 kHz	16 bit	This is the format used on standard audio CDs.
44.1 kHz – 192 kHz	24 bit	These are formats used in professional studios and high-end recording equipment.

To cater for all different situations, Reason supports multiple sample rates and resolutions.

## Sample Rate settings for recording and playback

Reason handles all internal audio processing in 32-bit floating point resolution, with 64-bit summing in the mix bus in the Main Mixer Master Section. However, the resolution of the input and output audio is determined by the hardware audio interface. That is, if you have a 24-bit audio card, Reason will record and output audio in 24-bit resolution, and if you have a 20-bit audio card, audio will be recorded and played back in 20-bit resolution.

The recording and playback sample rate can be specified on the Audio tab in the Preferences dialog (accessed from the Edit menu (Win) or Reason menu (Mac)):

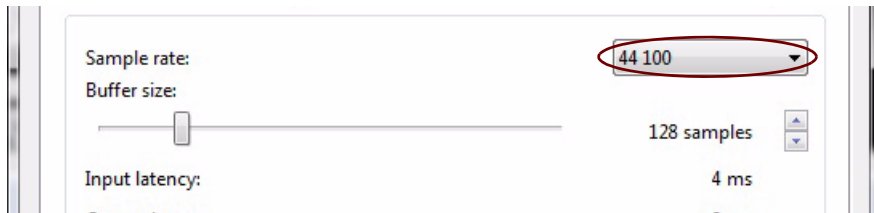

→ **Select the desired sample rate from the drop-down menu.**

Note that the available options on this pop-up menu depend on which sample rates are supported by the audio hardware.

! **Reason supports multiple sample rates in the same song!**

Reason allows import (or recording) of audio of any sample rate. If the original sample rate of a recording is different than the rate currently set for the audio card, Reason will automatically do a sample rate conversion.

First, a real-time sample rate conversion algorithm is used (allowing the audio to be played back immediately). Meanwhile, in the background, the program calculates a sample rate conversion of the highest quality, which will be used as soon as it is calculated. The CALC progress indicator on the transport panel lights up whenever the program is doing high quality calculations in the background:



*The CALC progress indicator on the Transport Panel appears when Reason performs high quality audio calculations.*

## Buffer Size settings

The Buffer Size can be adjusted on the Audio tab in the Preferences dialog (accessed from the Edit menu (Win) or Reason menu (Mac)):

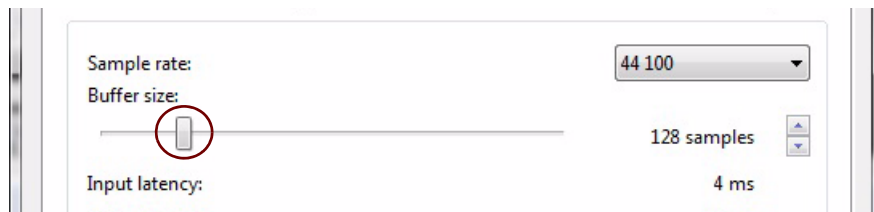

→ **Select Buffer Size by clicking and dragging the slider sideways.**

The trick here is to find the optimum relationship between audio quality, DSP Load and latency. Experiment with different Sample Rate settings in combination with different Buffer Size settings to get the best result.

A professional audio interface used together with a state-of-the-art computer should normally be able to handle a combination of a high sampling frequency (96 kHz) and a small Buffer Size (64-128 samples) without problems. A budget priced audio interface normally requires a lower sampling frequency (44.1 kHz) in combination with a little higher Buffer Size (256-512 samples).

See [“About latency”](#) for more information about buffer size and latency.

## CPU Usage Limit settings



In the “Miscellaneous” section on the “General” page in Preferences, you can define an upper limit for the CPU usage. If the DSP Load should exceed this set limit, the Reason application will stop receiving and outputting sound. If this happens, you might have to change the audio settings (see [“Sample Rate settings for recording and playback”](#) and [“Buffer Size settings”](#)) - or remove tracks and/or devices from your song. By default, the “CPU Usage Limit” is set to 80%. This is where the CPU load usually starts to make the sound crackle and distort.

## About MultiCore Audio Rendering

Reason fully supports multicore audio rendering. This means that if your computer has multiple CPU Cores (Dual Core or Quad Core, for example), or multiple CPUs, Reason takes advantage of this to significantly enhance the performance. A higher system performance allows for more tracks and devices in your songs.

If your computer has a multi-core CPU, or multiple CPUs, MultiCore Audio Rendering is active by default, as indicated on the “General” tab in Preferences:

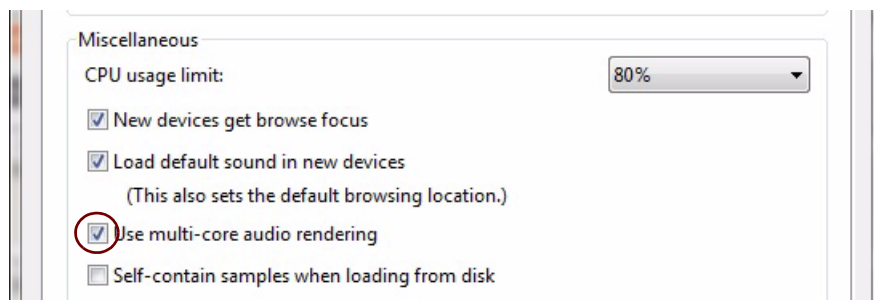

## Master Tune setting

By default, Reason plays back a “middle A” at 440 Hz, which is the standard tuning in most instruments. However, if you are playing Reason together with other instruments, you may want to adjust the tuning:

1. Select “Preferences...” from the Edit menu (Win) or Reason menu (Mac).
2. Click the “Audio” tab.
3. Adjust the global tuning with the Master Tune slider or button controls.

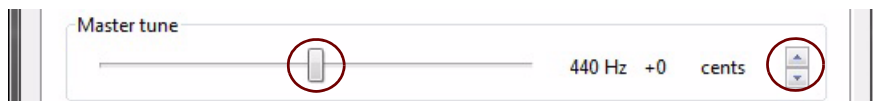

→ If you like, you can also adjust the Master Tune during playback.

! The Master Tune setting affects the tuning of all sound sources in Reason, including the Tuner function on the Audio Tracks. It also affects the tuning of the Redrum and Dr. Octo Rex loop player.

## About audio levels

When recording and playing back in Reason, you should keep an eye on the Audio In and Audio Out Clip indicators on the Transport Panel, or on the Hardware Interface and the Big Meter. You should also keep an eye on the clip indicators on the Main Mixer Master Section. If any of the clip indicators light up, the audio level is too high, resulting in clipping (digital distortion).

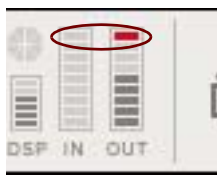

*The Clip indicators will stay lit for a short moment, to make them easier to spot.*

*The Clip indicators on the Audio In and Audio Out meters on the Transport Panel.*

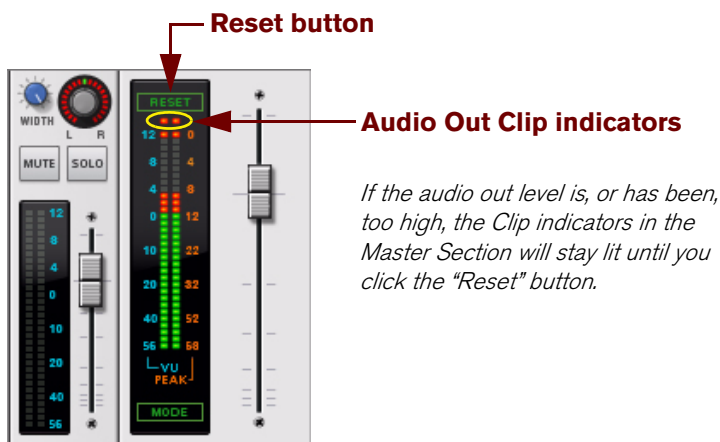

*The Clip indicators in the Master Section of the Main Mixer.*

! Note that if you use the Propellerhead Balance audio interface when recording audio tracks in Reason, you can use the unique Clip Safe function. The Clip Safe function allows you to heal clipped input signals! See “Recording using the Clip Safe function in Propellerhead Balance” for more information.

- ! Note that the Main Mixer Master Section Clip indicators will only work if there are no other devices connected between the Master Section device and the Hardware Interface!

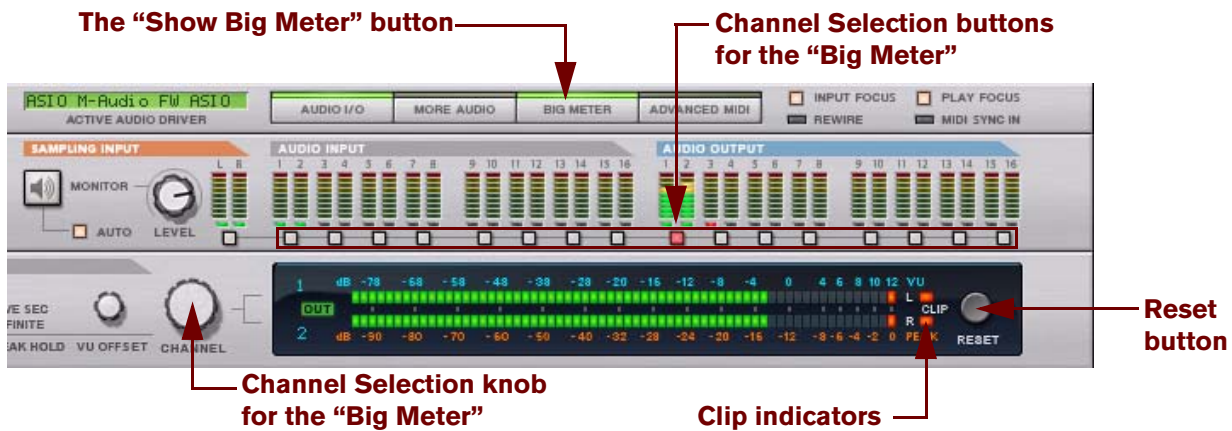

*The Big Meter on the Hardware Interface.*

- To remedy Audio In clipping, adjust the level at the input source, i.e. on the hardware audio interface or on the preamp connected to the hardware audio interface.
- ! When recording or sampling external audio signals, clipping cannot be adjusted in the Reason application - it must be adjusted at the audio input source!
- ! When sampling audio internally from devices in the rack, you have to adjust the Output Level on the source device to make sure clipping doesn't occur in the Hardware Interface.
- To remedy Audio Out clipping, lower the master level on the Mixer (or other device) that is connected to the Hardware Interface, until Audio Out clipping doesn't light up on playback.  
You could also use the MClass Maximizer as an insert effect on the Master Section in the Main Mixer to ensure that clipping never occurs - see ["The MClass Maximizer"](#).
- To get a better overview of the levels, bring up the Big Meter on the Hardware Interface, by clicking the "Big Meter" button on the front panel. Then, select the input or output pairs to view in the Big Meter by clicking on the corresponding channel selection button below each input or output pairs. Alternatively, select channel by turning the channel selection knob.  
If the audio level is, or has been, too high, the Clip indicators on the Big Meter will stay lit until you click the Reset button, or select new audio channels for the Big Meter.
- ! In some situations, the Audio Out Clip indicator on the Transport Panel and the Output Clip indicators on the Reason Hardware Interface might light up if the metronome Click is active in the sequencer during playback (see ["Click and Pre-count"](#)). This is nothing to worry about and won't cause any distortion in your song. To determine if the metronome is causing the clipping indication, just disable Click and see if the clipping stops.
- ! Note that it doesn't matter if the level meters on the individual devices (effects, Mixer channels, etc.) "hit the red". Output clipping can only occur in the Hardware Interface.

The technical reason for this is that internally, Reason uses high resolution floating point processing, which ensures highest audio quality and virtually limitless headroom. In the Hardware Interface, the floating point audio is converted to the resolution used by the computer's audio interface, and that's where audio out clipping might occur.

## If you are using multiple outputs

If you are using an audio interface with more than two outputs, you might want to have different devices connected to different outputs. If the Audio Out Clip indicator on the Transport Panel lights up, you should play back the section again while checking the Reason Hardware Interface. Each output socket has a level meter - if the red meter segment lights up, the output is clipping.



*Output 7 indicates audio clipping.*

*The indicator for Output 7 on the Hardware Interface indicates clipping.*

- **If necessary, bring up the Big Meter and select the output pair where the clipping occurs. Lower the output level of the device connected to the clipping output, until no clipping occurs.**

## If you are using ReWire

If you are streaming audio to another application using the ReWire protocol, clipping can not happen in Reason. This is because the conversion from floating point audio happens in the other audio application. See ["ReWire"](#) for more information.



# System signal paths

Depending on the track types in the sequencer, the default signal chain varies. In this section we're going to describe the default audio signal paths for Audio Tracks and Instrument Tracks.

## Audio Track signal paths

When you're recording and playing back audio that originates from an external source, like a guitar or a vocalist, the audio signal must first travel from the source, via a hardware audio interface, into the Reason application. Then, when played back, the audio travels from the Reason application, via the hardware audio interface, to a speaker system or similar. The figure below shows a schematic overview of the audio signal paths for a "standard" auto-routed Audio Track in Reason:

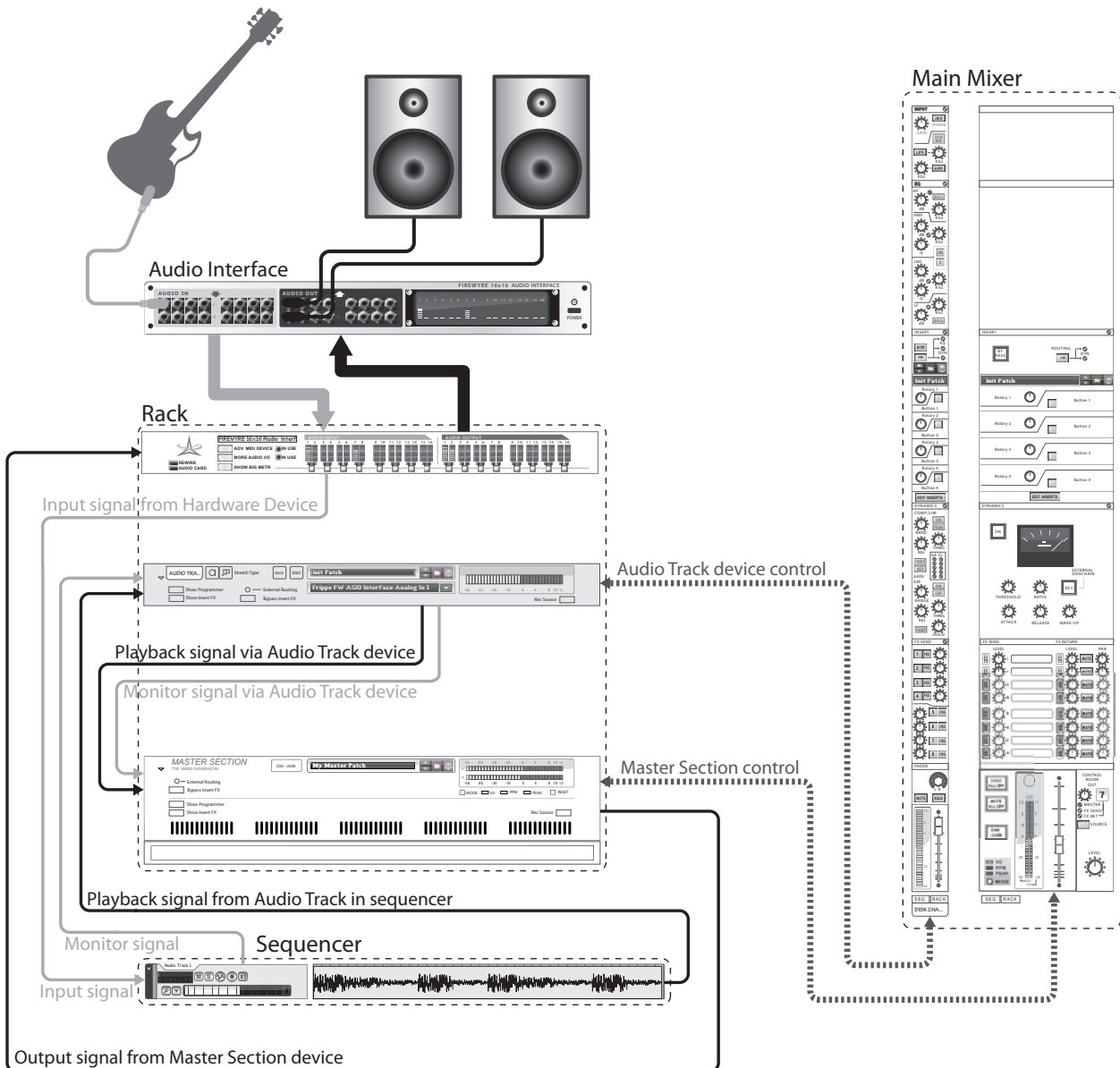

An Audio Track signal path in Reason.

# Instrument Track signal paths

When you're recording and playing back audio from an instrument device, like the ID8 Instrument device, the audio signal only has to travel only in one direction: from the Instrument device, via the hardware audio interface, to a speaker system or similar. The figure below shows a schematic overview of the audio signal paths for an auto-routed Instrument Track in Reason:

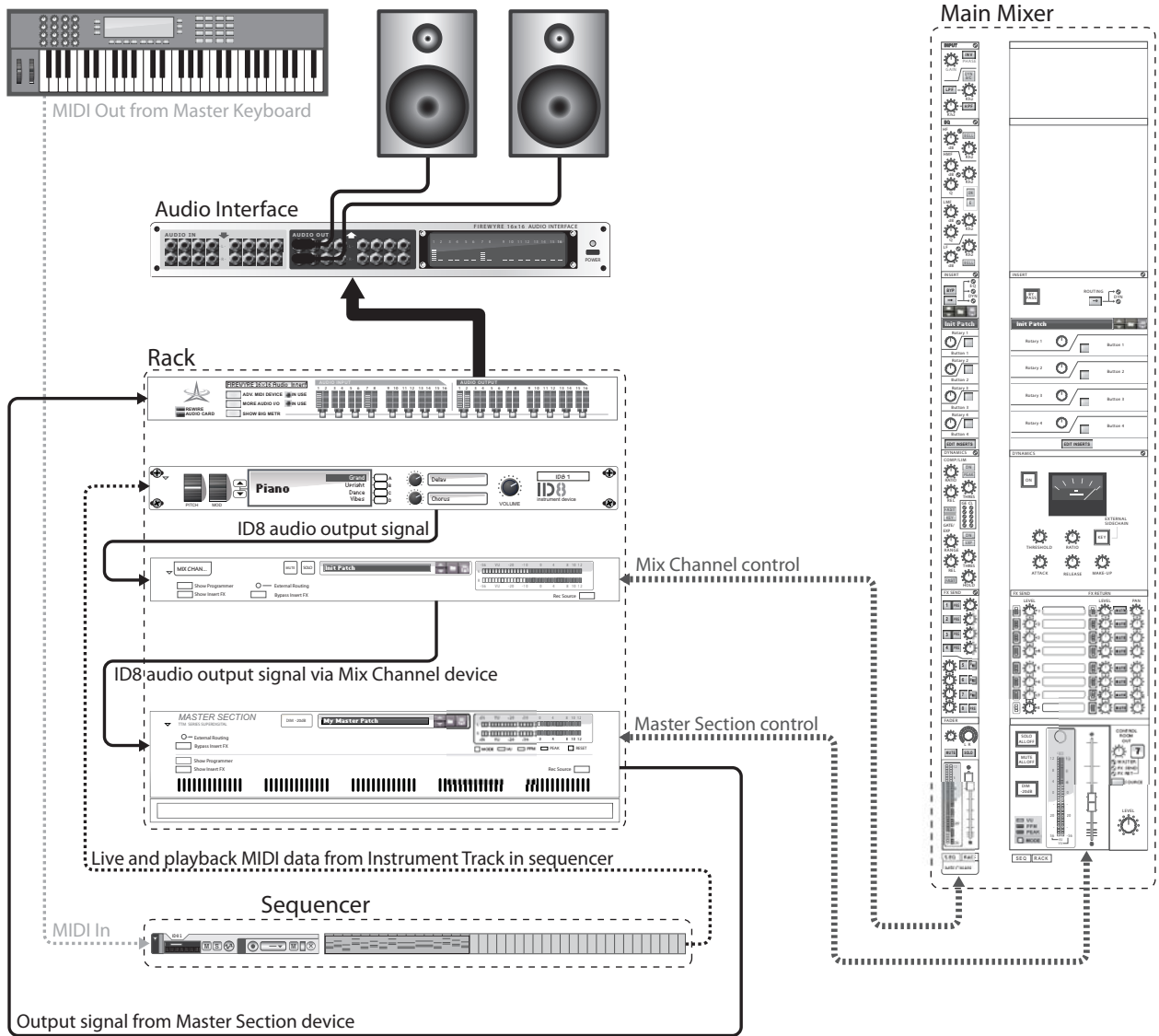

An Instrument Track signal path in Reason.

# General information about audio and computers

## About latency

On any personal computer system, there is a delay between the moment you input a sound, or “tell” the hardware to play a sound, and when you actually hear it. This delay is referred to as the “latency” of the design. This imposes a problem for any system where you want real-time user input to affect the sound.

### Why is there latency?

All audio applications receive and generate their audio in chunks. These chunks are then passed on to the audio card where they are temporarily stored before being converted into regular audio signals. The storage place for these chunks are called “buffers” (an analogy would be a bucket brigade, where a number of people each have a bucket, and water is poured from one bucket to another to reach its final destination).

The smaller the buffers and the fewer they are, the more responsive the system will be (lower latency). The general rules regarding the buffer size are these:

- **A small buffer size reduces the latency (the time it takes for the audio to “travel” from the audio interface input(s) to the application and from the application to the audio interface output(s)).**  
However, a small buffer size also increases the DSP Load. Too small a buffer size setting could also make the sound crackle and distort.
- **A large buffer size reduces the DSP Load (allowing for more tracks to be played back simultaneously) and also ensures good audio quality.**  
However, a large buffer size also increases the latency.

A high sample rate will also reduce the latency. However, this will also raise the demands on the computer and its software. If the system can't cope with moving the data to and from the buffers fast enough, there will be problems that manifest themselves as glitches in audio playback.

To make things worse, audio playback is always competing with other activities on your computer. For example, a buffer size that works perfectly under normal circumstances might be too small when you try to open files during playback, switch over to another program while Reason is playing or simply play back a very demanding song.

### What is acceptable?

On a regular PC, the latency can vary quite a lot. This is an effect of the fact that computers and their operating systems were created for many purposes, not just for recording and playing back audio. For multimedia and games, a latency of a 100 ms might be perfectly acceptable, but for recording and playing back audio it is definitely not!

- **PC audio cards running under Windows with a MME driver might at best give you a latency of around 160ms.**
- **The same card with a DirectX driver running under Windows provides at best around 40ms.**
- **A card specifically designed for low latency, with an ASIO driver under Windows, or a Core Audio driver under Mac OS X, can usually give you figures as low as 2-3 ms. This is definitely good enough for audio applications. That's also why ASIO or Core Audio drivers are required to run Reason.**

### Reason's built-in sequencer is not affected by latency

When Reason's sequencer is playing back a song, the timing between notes and audio is perfect! Once playback of a Reason pattern or song is up and running, latency isn't a consideration at all. The computer clocks the audio between the steps and does this with perfect quartz accuracy! The timing is immaculate!

## ReWire and Latency

When you run Reason as a ReWire slave, it is the other program, the ReWire master, that is responsible for actually rendering the audio and playing it back via the audio card. It means that any latency is present in the ReWire master.

- ! **When Reason runs as a ReWire slave, what audio hardware you have, what audio driver you use, and the audio settings you have made in the Preferences dialog are of no importance at all! All audio hardware settings are then instead made in the ReWire host application.**
- ! **Note, however, that you may have to adjust the “External Sync Offset” in Preferences if Reason is synced via MIDI from the host application (see “[External synchronization considerations](#)”).**

For information on ReWire, see “[ReWire](#)”.

## Reducing latency

There are a few general methods for making sure latency is as low as possible:

- **Make sure you are using the latest version of the drivers for your hardware audio interface.**
- **Adjust the Sample Rate and Buffer Size parameters as described in “[Audio settings](#)”.**
- **Remove unnecessary background tasks on your computer.**  
This might be any background utility you have installed as well as networking, background internet activities etc.
- **Optimize your songs.**  
You might run into situations where you have to raise the Output Latency setting to be able to play back a very demanding song on your computer. Another option would be to actually optimize the song. See “[Optimizing Performance](#)” for details.
- **Get a better audio interface.**  
This is only required if you find that you need to increase Output Latency because your audio card can't really cope with the songs you try to play.
- **Get a faster computer.**  
This is only required if you find that you need to increase Output Latency because your computer can't really cope with the songs you try to play.

## About processors

When you run Reason, the clock speed of the processor is a major factor determining how many audio tracks and devices you can use at the same time.

If you plan to buy a computer specifically for Reason, you could play it safe and choose a computer with at least a dual-core Intel P4 dual core processor, or equivalent AMD processor, running at 2.0 GHz or faster. MultiCore processors will give better performance and are highly recommended.

## About RAM

Another important performance factor is the amount of installed RAM in the computer. Generally, one could say: the more the better, especially if you're running several applications simultaneously. To run Reason, a minimum of 4 GB RAM is required, but more is recommended for even better performance.

# **Chapter 5**

## **Sequencer Functions**

# About this chapter

This chapter describes the layout and general functions of the main sequencer. Recording, editing clips and events, arranging and working with Blocks in the sequencer are described in detail in the chapters “Recording in the Sequencer”, “Audio Editing in the Sequencer”, “Note and Automation Editing”, “Arranging in the Sequencer” and “Working with Blocks in the Sequencer”.

## Introduction

The sequencer is where you record your songs. The sequencer can be used to record audio tracks as well as instrument tracks, performance controllers, parameter automation and pattern automation. You can also arrange your songs, or parts of your songs, in Blocks. In Blocks mode you can build complete “sections” - consisting of a desired number of bars and tracks - that can be reused throughout the song. This chapter mainly describes the Song View and Edit Mode. Functions specific to Blocks and the Blocks View are described in the separate chapter “Working with Blocks in the Sequencer”.

## Sequencer area overview

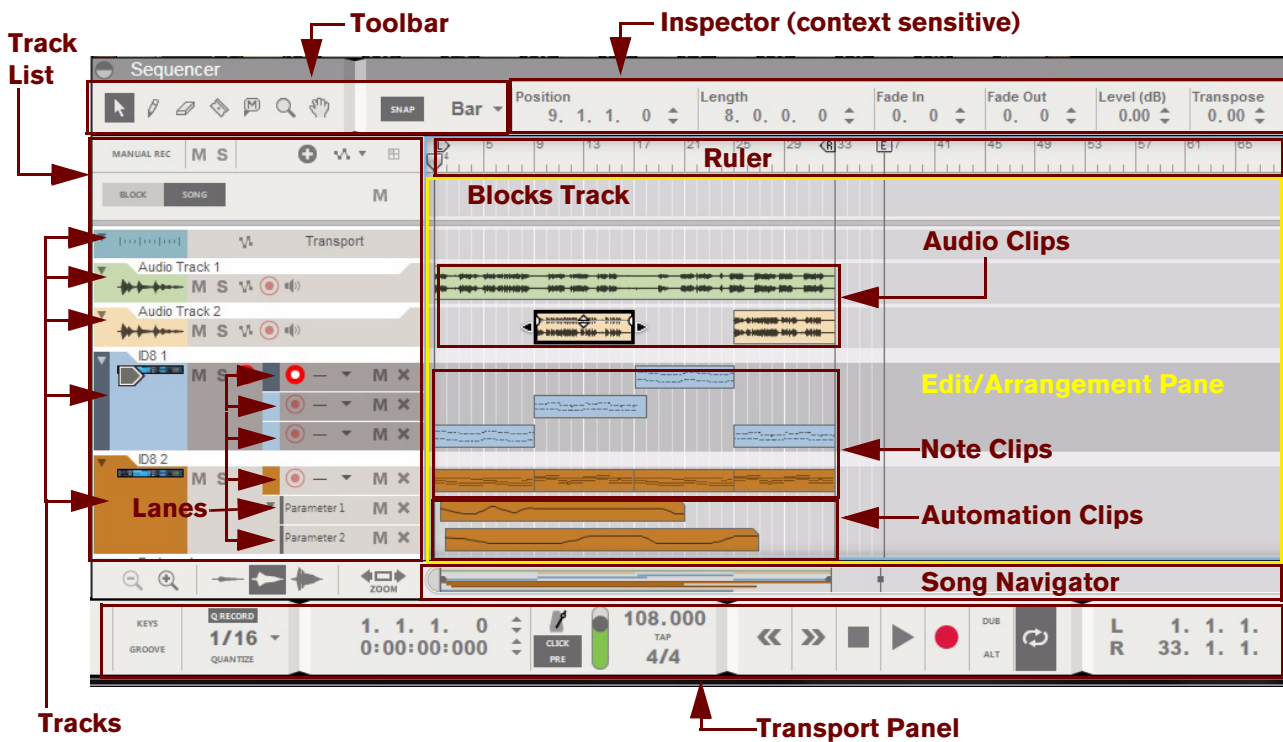

# Song View and Edit Mode

The Song View is the “normal view” where you are working with your song arrangement. This mode gives a good overview of the contents of the tracks in your song. If the Enable Blocks function on the Options menu is active, the Blocks track is also visible at the top in the Track List. If the Enable Blocks function is off, there is no Blocks track in the Track List.

On the Blocks track you arrange the Block automation clips that control which Block should play back (see “Working with Blocks in the Sequencer”).

Edit Mode is where you edit the contents of the clips in your song. To enter Edit Mode, hold down [Ctrl](Win) or [Cmd](Mac) and press [E]. In Edit Mode the Edit Pane shows detailed information about the content of one track (see “Tracks overview”), or lane (see “Lanes overview”) at a time and you can edit the events in individual clips (see “Clips overview”).

- ▶ **When you open a note or Comp audio clip by double-clicking it in Song View (or Block View), the sequencer automatically switches to Edit Mode. However, if you double-click a Single Take audio clip or parameter automation clip, it opens up for editing inline, directly in the Song View or Block View.**

## Song View

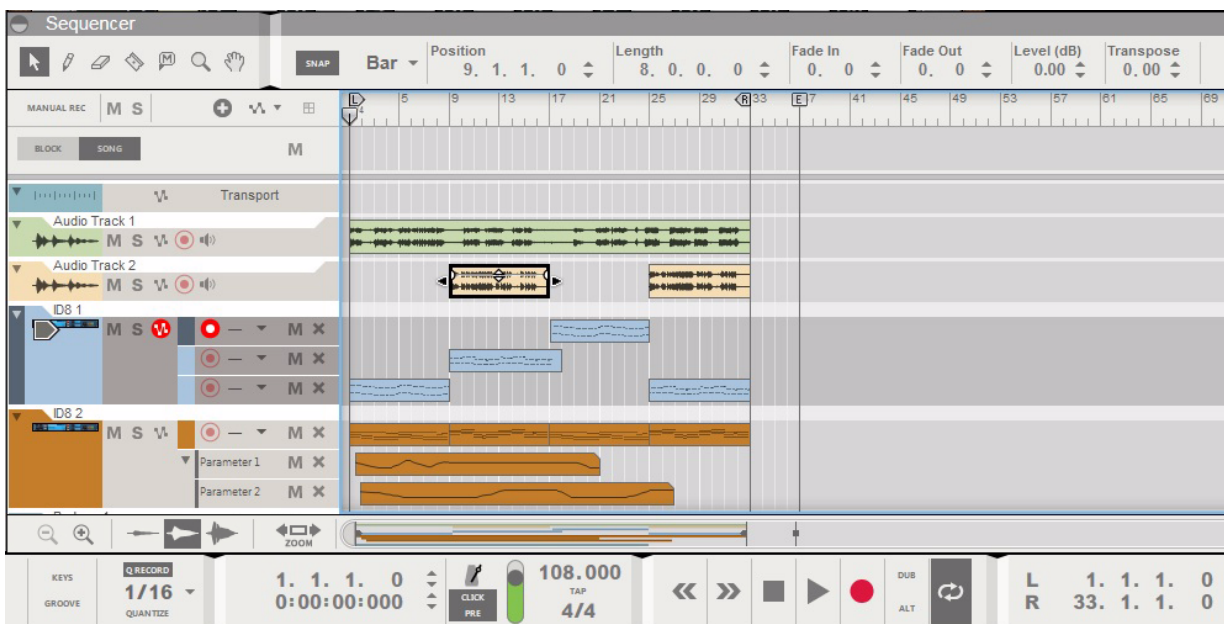

In the Song View, all clips on all tracks can be viewed. Use this mode to get an overview of your arrangement, and when you want to perform clip-based editing such as rearranging whole sections of your song, etc.

- ! **Note that if the Enable Blocks function on the Options menu is off, there is no Blocks track in the Track List.**

## Edit Mode

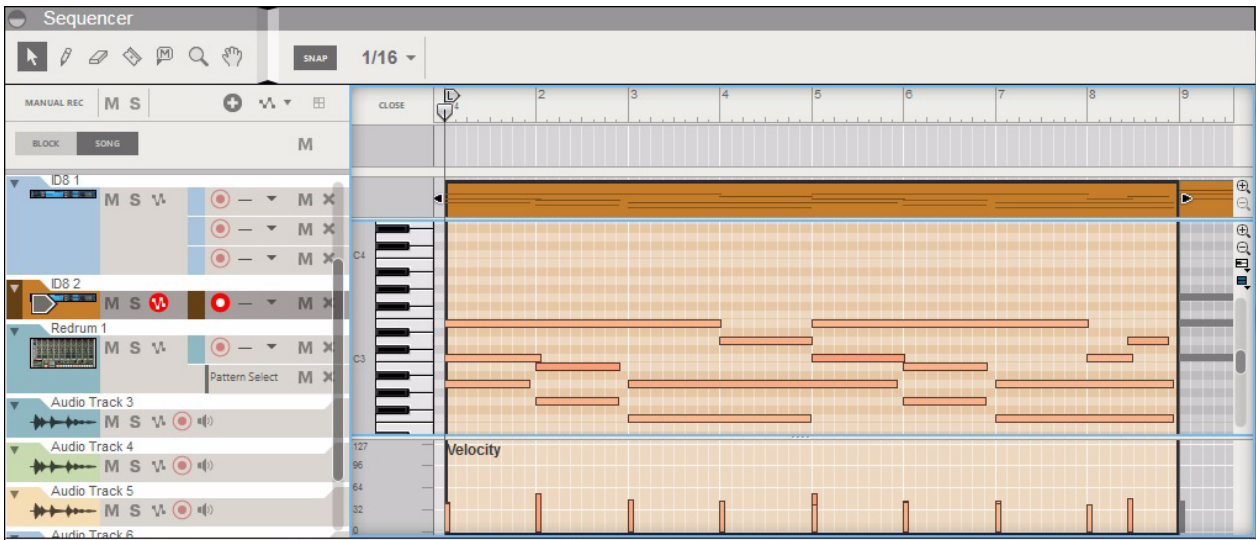

In Edit Mode, you get a close-up look at the recordings on a track. In Edit Mode, the Edit Pane can be divided into several horizontal edit rows, showing different types of events (notes, velocity, audio, parameter automation, etc.). This is the view mode of choice for fine editing the content of your recorded clips, and for drawing notes, performance controllers and other events manually.

## Toolbar overview



The sequencer Toolbar features various sequencer editing tools as well as the Snap function. The tools can be used in both Edit Mode and the Song/Block Views, with slightly different purposes in the respective modes. See [“Toolbar details”](#) for details about each tool.

## Track List overview



To the left in the sequencer, all tracks are listed in the Track List. Each track in the sequencer is associated with a specific device in the rack. By clicking on a device icon in the Track List you automatically set Master Keyboard Input (see [“Setting Master Keyboard Input”](#)) to the corresponding device in the rack for playing and/or recording.



## Tracks overview

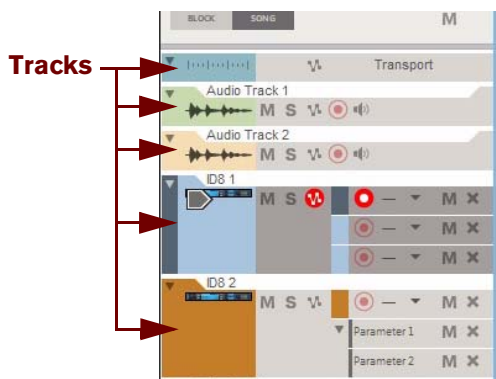

Most rack devices in a song automatically get their own dedicated track in the sequencer when you create the device. Each track can feature one or several lanes on which audio, note, performance controller, pattern and parameter automation events can be recorded - in clips. See [“Track details”](#) for more details about tracks.

**! If the Blocks button on the Transport Panel is on, the Blocks Track is also shown at the top in the Track List.**

## Lanes overview

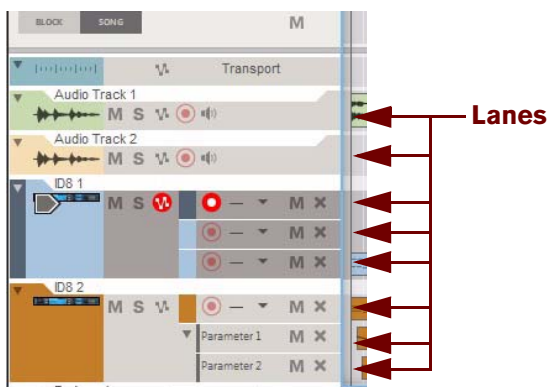

Each track consists of one (default) or several parallel lanes. The lanes can contain clips that feature note events or audio recordings, depending on track type. A track can also feature automation lanes that contain clips with parameter automation events - or pattern automation for pattern based devices. See [“Lane details”](#) for more details about lanes.

## Clips overview

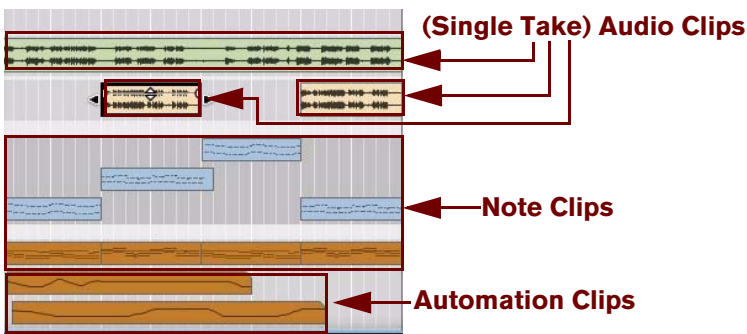

Note, audio, performance controller, pattern and parameter automation events are always contained in clips. A clip is basically a “container” for recorded data. Audio clips are displayed in the Edit/Arrange Pane as a rectangular box with one or two graphical audio waves inside (mono or stereo). Note events are displayed in a “piano roll” fashion in the clip. Performance controllers and parameter automation events are displayed as continuous lines, and pattern events are displayed as repeated rectangles in the clips. See [“Clip basics”](#) for information about the different clip types.

## Inspector overview

Position	Length	Fade In	Fade Out	Level (dB)	Transpose
9. 1. 1. 0	8. 0. 0. 0	0. 0	0. 0	0.00	0. 00

The context sensitive Inspector shows the properties of whatever is currently selected in the sequencer: clips, notes, automation events, audio comp rows and cuts etc. The properties of the selected item can be edited by changing the values in the various displays. See [“About the Inspector”](#) for more info.

## Ruler overview

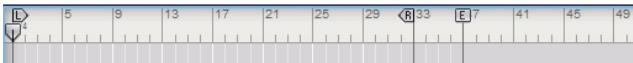

The Ruler is the song’s “time line”, measured in bars. In the Ruler, the Song Position Pointer indicates the current position in the song, i.e. in which bar the song is, or will begin, playing. The Ruler also shows the Left and Right Loop Locators as well as the Song End Marker. See [“Ruler details”](#) for more details.

## Edit/Arrangement Pane overview

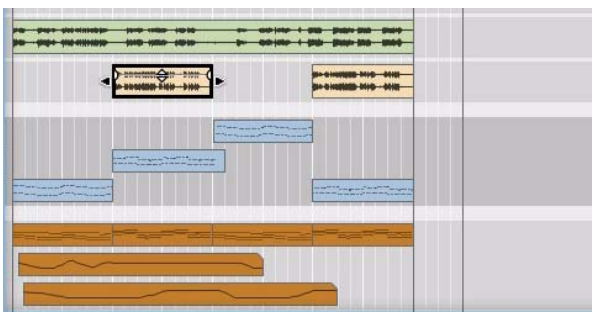

The big center section of the sequencer is called the Edit/Arrangement Pane. This is where all recorded events reside in clips - on one or more lanes on the respective track.

## Track scrollbar overview



To the far right in the sequencer is the Track scrollbar. With the Track scrollbar you can scroll vertically on the Edit/Arrange Pane. See [“Scrolling”](#) and [“Zooming in the Sequencer”](#) for more details.

## Song Navigator overview



Below the Edit/Arrangement Pane is the Song Navigator. With the Song Navigator you can scroll and zoom horizontally on the Edit/Arrangement Pane. The Song Navigator also features indicators for the Ruler’s Loop Locators, Song Position Pointer and Song End Marker. In the Song Navigator, all clips on all lanes are displayed as colored lines, indicating their positions in the song. See [“Scrolling”](#) and [“Zooming in the Sequencer”](#) for more details.

## Transport Panel overview

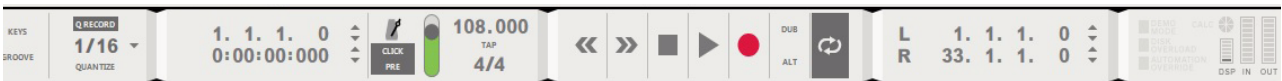

The Transport Panel features the sequencer transport controls (Rewind, Fast Forward, Stop, Play and Record) as well as controls for Tempo, Time Signature, Position, Time and Loop Locator placements and some other functions. See [“Transport Panel details”](#) for more details.

# Track details

## Track definition

The tracks in the sequencer are where you record your audio, note and automation to create your songs. A track is always associated with a device in the rack (except for the Transport track and Blocks track). An icon with a picture of the associated device is shown in the Track List on the left hand side in the sequencer. In the Track List, the name of the associated device is shown, as well as icons and buttons related to the specific track. Each track can incorporate various lane types (depending on track type). To the right of the Track List - on the Edit/Arrangement pane - each track has its own dedicated area for recorded events.

In the picture below, six sequencer tracks are shown. From the top down are the Transport Track (which is always present and cannot be moved or deleted), two audio tracks, two instrument tracks associated with one ID8 instrument device each, and one automation track for a Mix Channel strip.

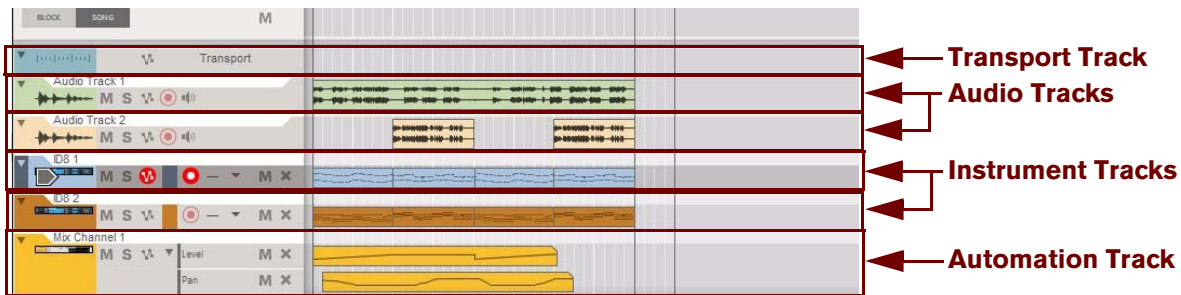

# The relationship between the track, the rack and the Main Mixer

A track in the sequencer is always associated with a device in the rack; i.e. there can never be a sequencer track without an associated rack device (except for the Transport track and Blocks track). Audio Track devices and Mix Channel devices in the rack also have their corresponding channel strips in the Main Mixer. Mixer channel strips can be considered “remote controls” for their corresponding rack devices. Depending on track type, the signal chain differs somewhat. The picture below shows the signal flow in five scenarios with three different track types:

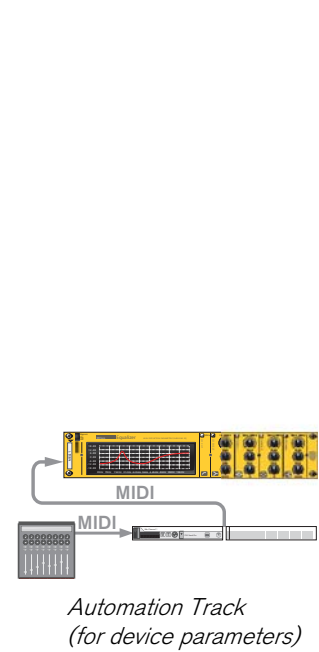
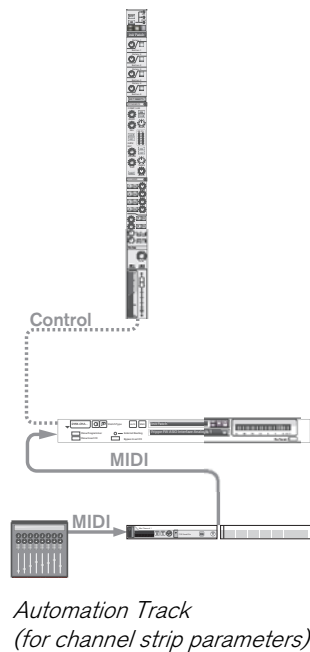
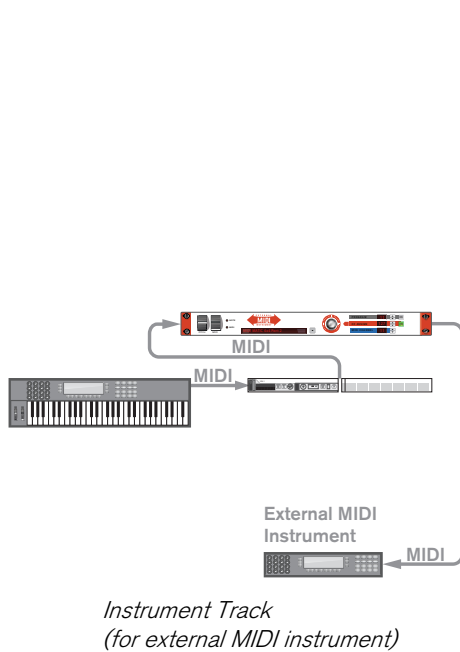
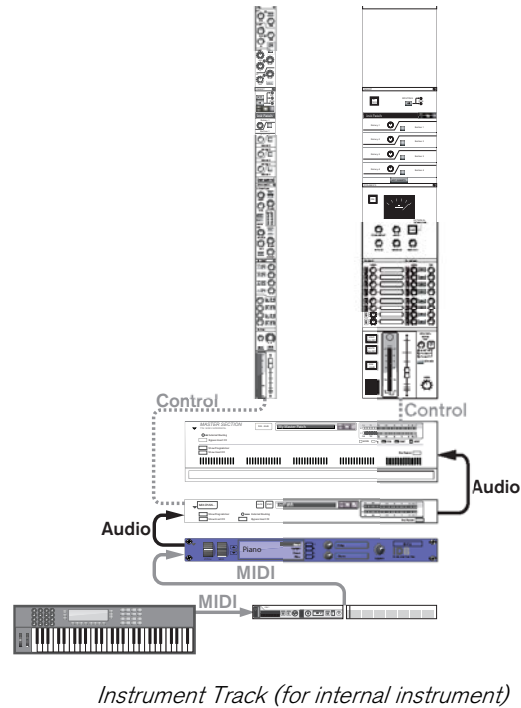
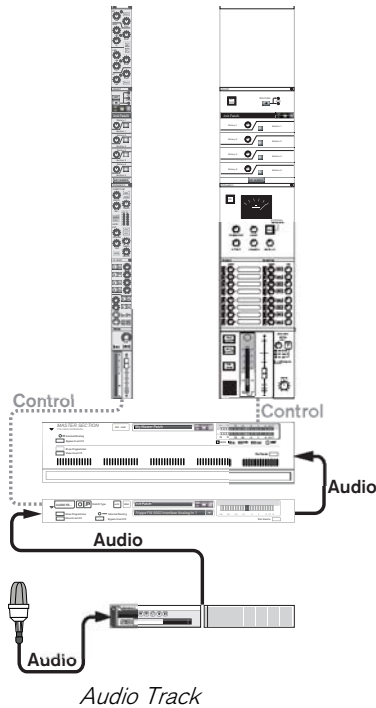

## Audio track relationships

An audio track is always associated with an Audio Track device in the rack and its corresponding Audio Track channel strip in the Main Mixer. An Audio Track device can also house insert effects.

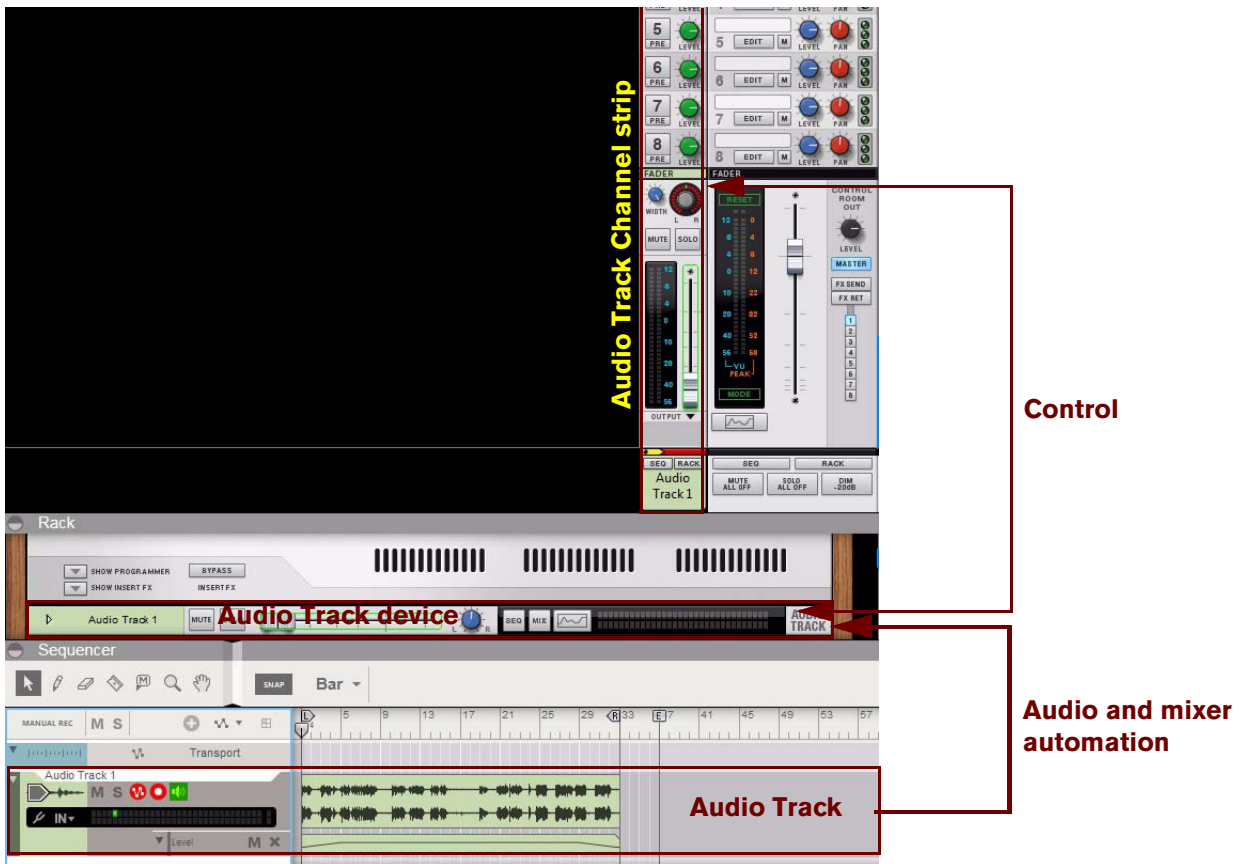

In the figure above, the audio track is associated with the Audio Track device in the rack, which in turn is controlled from the Audio Track channel strip in the Main Mixer. The audio track features recorded audio and mixer automation.

## Instrument track relationships (for internal instruments)

An instrument track is always associated with an instrument device in the rack. The instrument device in the rack is, in most situations, connected to a Mix Channel device in the rack. The Mix Channel device in the rack is controlled from the corresponding channel strip in the Main Mixer. A Mix Channel device can also house insert effects.

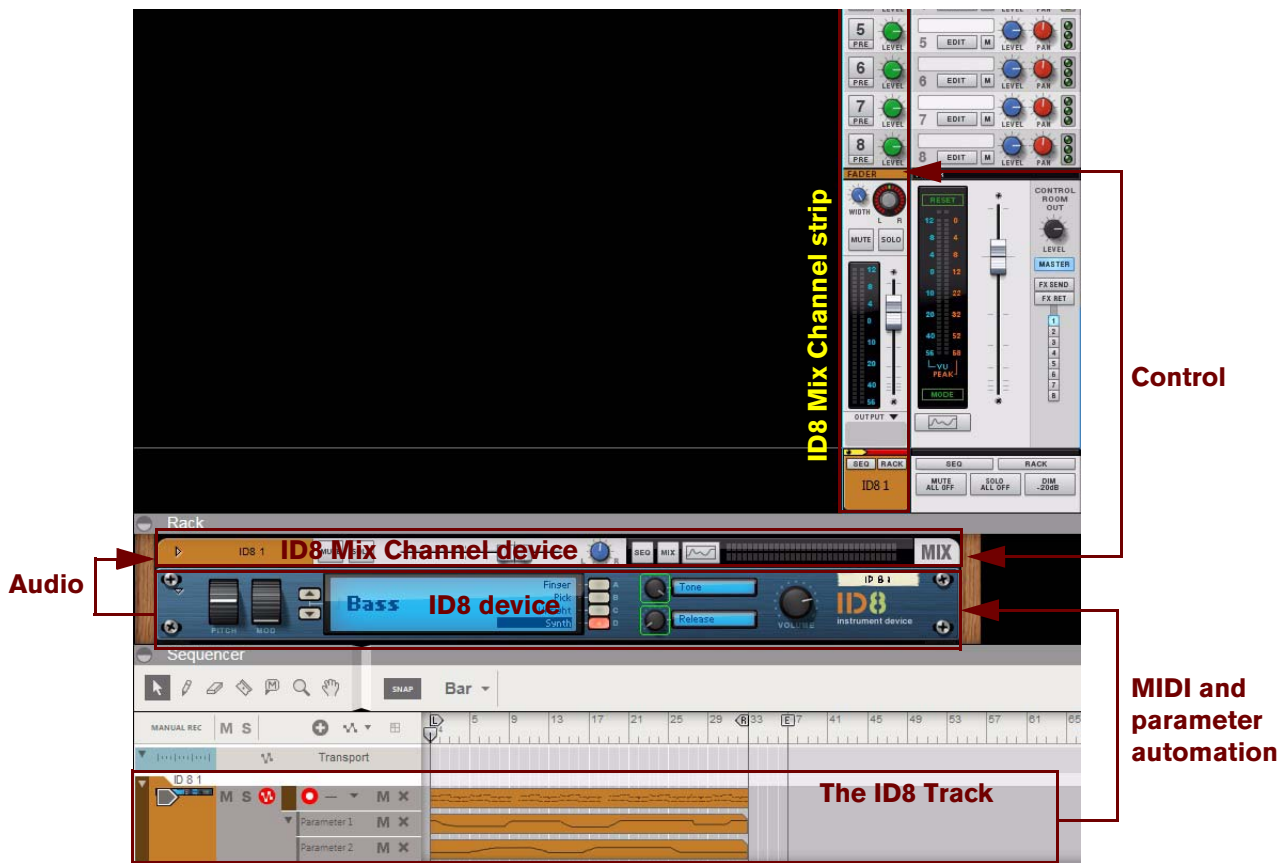

In the figure above, the ID8 track is associated with the ID8 instrument device in the rack. The ID8 instrument device is connected to the ID8 Mix Channel device in the rack, which in turn is controlled from the ID8 channel strip in the Main Mixer. The ID8 track features recorded MIDI notes and parameter automation.

Note that when you create an instrument, the connected Mix Channel device doesn't automatically get a track in the sequencer. If you want to record Mixer Channel automation, you have to first create a separate sequencer track for the Mix Channel device. See "[Automation \(non-instrument\) track relationships](#)".

## Instrument track relationships (for external MIDI instruments)

If you want to control an external MIDI instrument from the Reason sequencer you have to use the External MIDI Instrument device ("External MIDI Instrument"). The device works as a MIDI router in which you can define which MIDI Out Port and MIDI Channel you want the MIDI signals to be sent to from Reason. Since there is no internal audio involved in this setup, there is no Audio Track device or Mix Channel device present in the configuration.

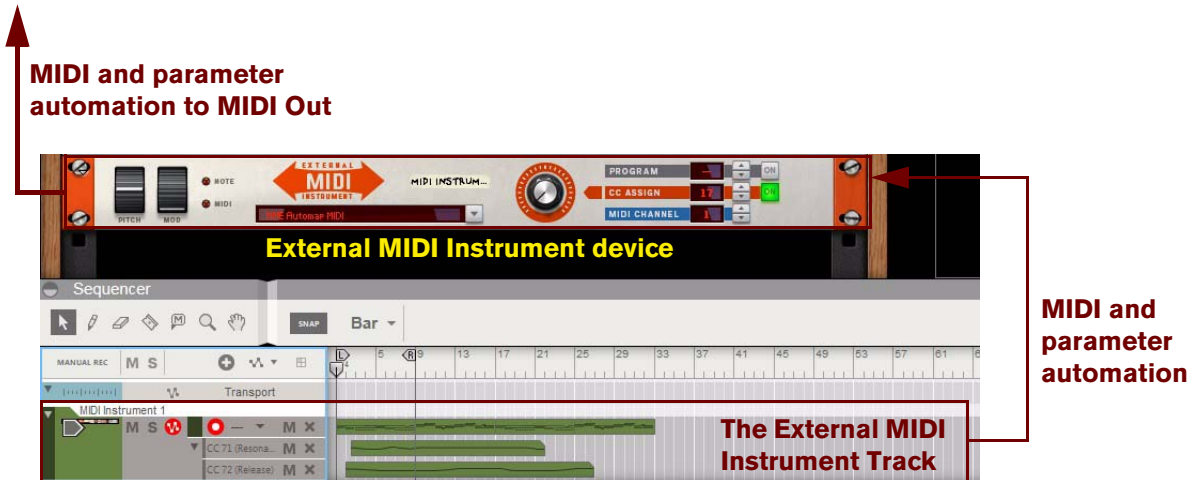

In the figure above, the External MIDI Instrument track is associated with the External MIDI Instrument device in the rack. The External MIDI Instrument track features recorded MIDI notes and parameter automation (MIDI CC#) that is sent via the External MIDI Instrument device to the desired MIDI Out Port and MIDI Channel.



## Automation (non-instrument) track relationships

A pure automation track is always associated with a “non-instrument” device, i.e. a device which can't receive MIDI *Note* information. Consequently, an automation track can only consist of parameter automation lanes. Examples of non-instrument devices are Mix Channel devices with their corresponding Mix Channel strips, effect devices, mixer devices and Spider Merger & Splitter devices. The picture below shows an example with an automated Mix Channel:

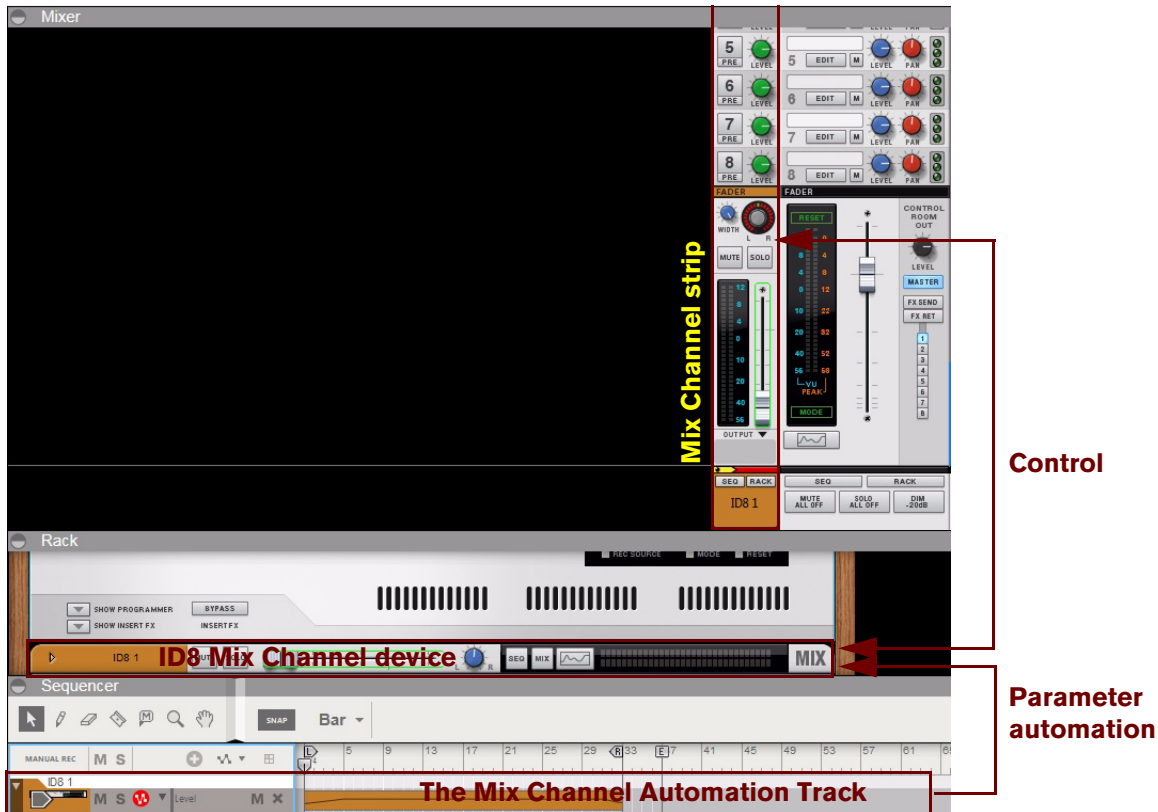

In the figure above, the Mix Channel automation track is associated with the Mix Channel device in the rack, which in turn is controlled from the channel strip in the Main Mixer.

The picture below shows an example with an automated MClass Equalizer device. Note that no mixer channel strip is involved in this situation since the automation only concerns a non-instrument device and not any Mix Channel device:



In the figure above, the Equalizer automation track is associated with the Equalizer device in the rack.

## Master Keyboard Input

The standard way of routing MIDI from a connected MIDI master keyboard or control surface to a device in the rack is to set the Master Keyboard Input in the sequencer. When MIDI is routed to a selected track in the sequencer, the notes and controller data are automatically echoed to the associated device in the rack. However, it is also possible to set Master Keyboard Input from the rack, see [“Playing devices from the rack”](#).

- **Setting Master Keyboard Input to an instrument track is necessary if you want to play notes on an instrument device from your MIDI master keyboard (and control the instrument device parameters via MIDI).**  
By locking additional MIDI keyboards to separate devices in the rack, you will be able to play and record on several sequencer tracks simultaneously, see [“Locking a surface”](#).
- **Setting Master Keyboard Input to an audio track is only necessary if you want to control the Main Mixer channel strip parameters via MIDI.**
- **Setting Master Keyboard Input to a “non-instrument” (parameter automation only) track is only necessary if you want to control the device’s parameters via MIDI.**

Besides the standard routing described above, it’s also possible to lock certain rack devices to specific control surfaces. See [“Locking a surface”](#) for more details.

! **If you have several MIDI keyboards/control surfaces locked to individual devices in the rack, it is possible to control and record on several tracks simultaneously!**

### Setting Master Keyboard Input

→ **To set Master Keyboard Input to a track and its associated device, click the device icon in the Track List.**



*Master Keyboard Input set to an instrument track.*



*Master Keyboard Input set to an audio track.*

The track gets a gray “arrow” symbol to the left, indicating that the track and associated device has Master Keyboard Input. The track and device will now respond to incoming MIDI data from a connected MIDI keyboard/control surface. By default, setting Master Keyboard Input also automatically selects the track, which is indicated by the gray color of the track in the Track List.

It’s also possible to set Master Keyboard Input and track selection independently from each other by selecting “Separated” on the “Keyboards and Control Surfaces” page in Preferences - see [“Preferences – Control Surfaces”](#).

- **Only one track at a time can have Master Keyboard Input. However, if you have locked additional MIDI keyboards to specific devices in the rack via Remote (see [“Locking a surface”](#)), you will be able to play and record these together with the track that has Master Keyboard Input.**

## The relationship between tracks, lanes, clips and events

A track is the top level in the sequencer Track List hierarchy. A track can consist of one or several parallel lanes. A lane can contain clips, which in turn can contain audio recordings, note events, performance controller events, parameter automation events or pattern events, depending on track type.

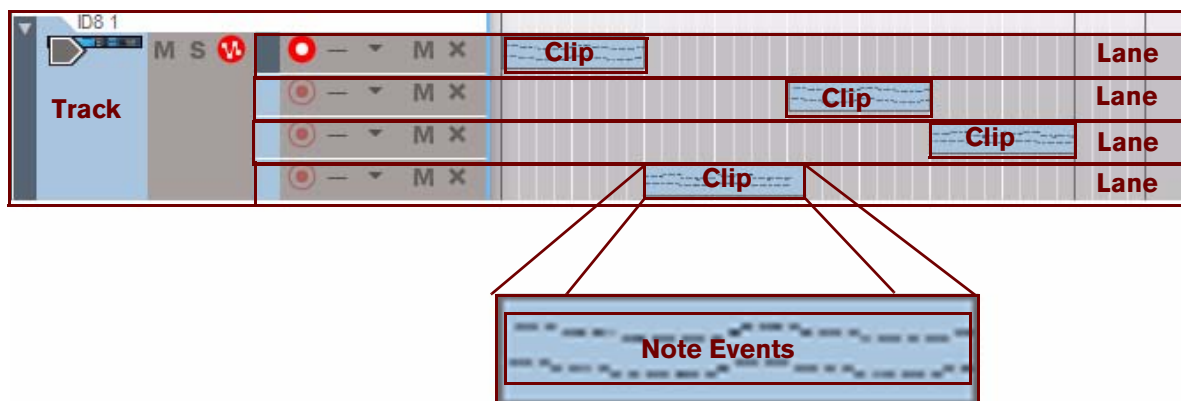

*An instrument track with four note lanes featuring clips with note events.*

- **A device in the rack can never have more than one track in the sequencer.**
- **A clip is a “container” for various types of events (audio recordings, note, performance controller, parameter automation or pattern events).**

## Track types

These are the different track types:

- **The Blocks track.**



The Blocks track is present at the top of the Track List only when the Enable Blocks function on the Options menu is on. On the Blocks track you can create Block Automation clips to decide which Blocks should play back. Refer to [“Working with Blocks in the Sequencer”](#) for more information about the Blocks feature.

- **The Transport track.**



The Transport track is always present at the top of the Track List and cannot be moved or deleted. The Transport Track can have a maximum of two lanes: one containing time signature automation, and the other containing tempo automation. See [“Automating time signature”](#) and [“Editing tempo automation”](#) for more details.

- **Audio tracks**

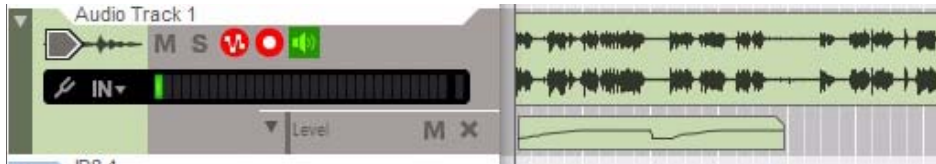

An audio track can only have a single audio lane containing clips with mono or stereo audio recordings. However, each audio clip can contain several recordings, i.e. different "takes". You can view and comp these takes in the Comp Editor. See ["Audio Editing in the Sequencer"](#) for more details. An audio track can also have parameter automation lanes containing automation for the Audio Track Channel strip parameters in the Main Mixer.

- **Instrument tracks**

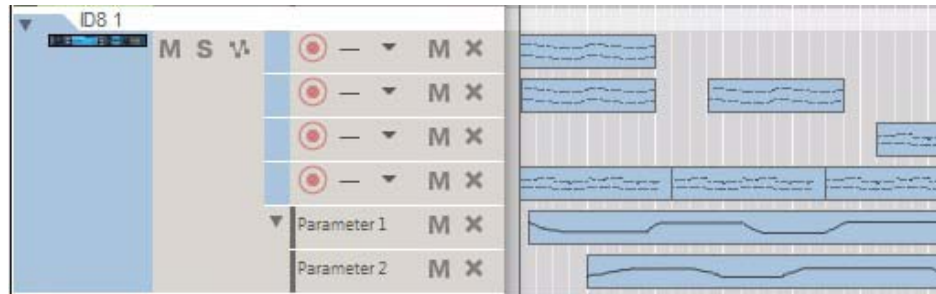

Devices that can receive MIDI notes, such as the ID8 device, will automatically be assigned a record enabled track when created. On an instrument track you can create a number of separate note lanes that can incorporate clips containing a combination of note and performance controller events. Multiple lanes are perfect if you, for example, are recording a drum track and want to record each drum sound on a separate lane. An instrument track can also have a number of parameter automation lanes that can contain clips with instrument parameter automation events.

- **Parameter automation ("non-instrument") tracks**

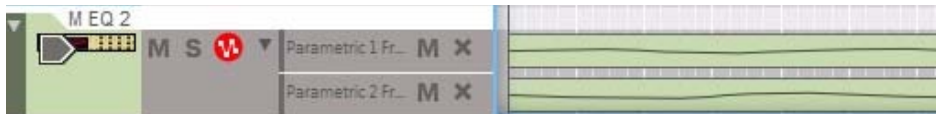

Tracks for devices that do not receive MIDI note data (e.g. effects and mixer devices and mixer channels in the Main Mixer) can only contain parameter automation lanes. These "non-instrument" devices are not automatically assigned a track when created. To automate parameters for non-instrument devices you need to manually create a track for these. The number of available lanes is limited by the number of parameters of each device. There can be one lane for each automatable parameter in the device.

## Track List elements

In the picture below, a Track List with four different tracks is shown. From the top down are the Transport Track (which is always present and cannot be moved or deleted), an Audio Track associated with an Audio Track device, an Instrument Track associated with an ID8 Instrument device and an Automation Track associated with the Mix Channel device.

The Transport Track in the picture features two parameter Automation Lanes (for Time Signature and Tempo) that have been manually created for the track. The audio track features only a single audio lane. The ID8 1 track features four note lanes and has two parameter automation lanes added. The Mix Channel 1 track is associated with the Mix Channel 1 device and has three parameter automation lanes added.

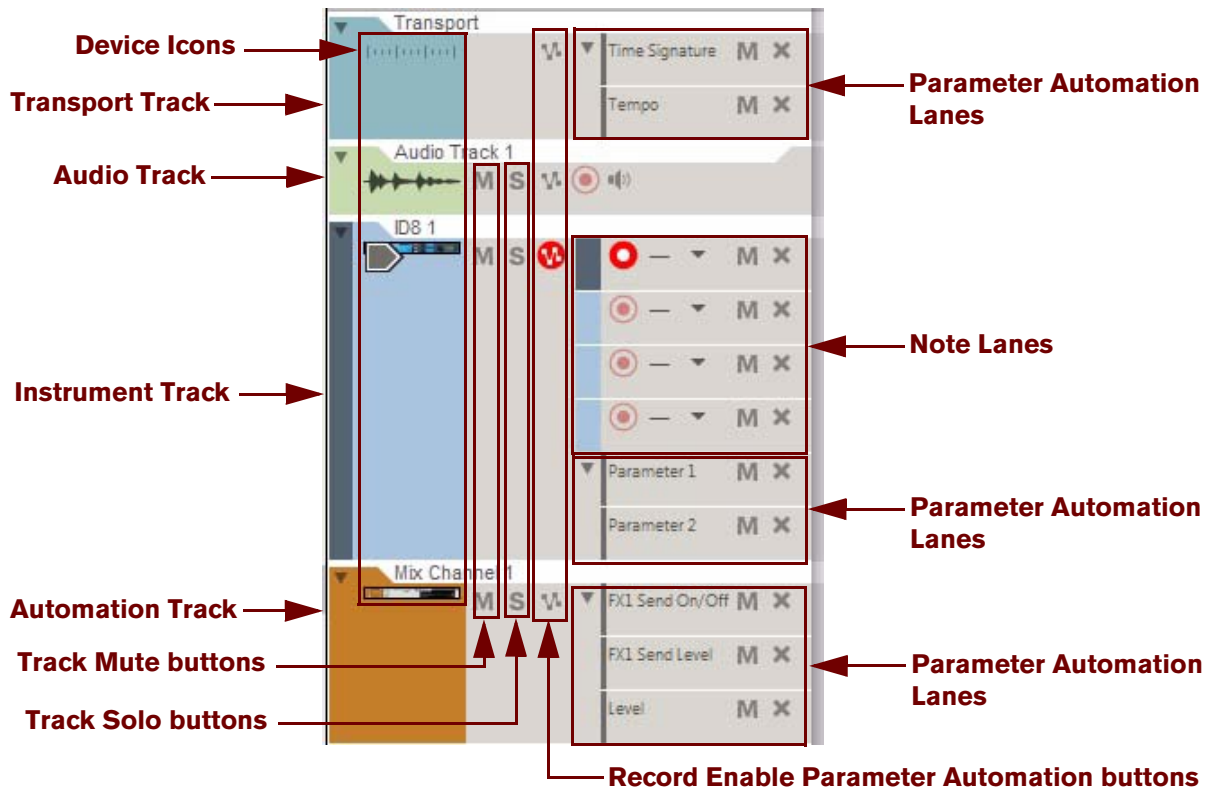

Depending on track type, the elements shown in the Track List can vary. The only common element for all track types is the "Record Enable Parameter Automation" button which should be enabled when you want to record parameter automation for the associated device. This and the other track elements will be described in detail later in this chapter.

## Creating tracks

### Creating an audio track

An audio track can be created as follows:

1. Hold down [Ctrl](Win) or [Cmd](Mac) and press [T]. Alternatively, select “Create Audio Track” from the “Create” menu or from the context menu in the Track List, rack or Main Mixer.

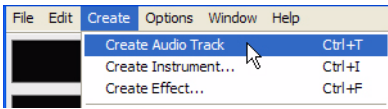

- Alternatively, double click the Audio Track device in the Utilities palette in the Browser.



2. An audio track is created in the sequencer and the associated Audio Track device is created in the rack. The Audio Track device's channel strip is created in the Main Mixer.

By default, the audio track is set up in mono. You can easily change to stereo by selecting “Stereo Input” in the “Audio Input” drop-down list - see “Selecting audio input(s) and defining mono or stereo”. If you select “Stereo Input”, the Audio Track channel strip in the Main Mixer automatically switches to a stereo channel.

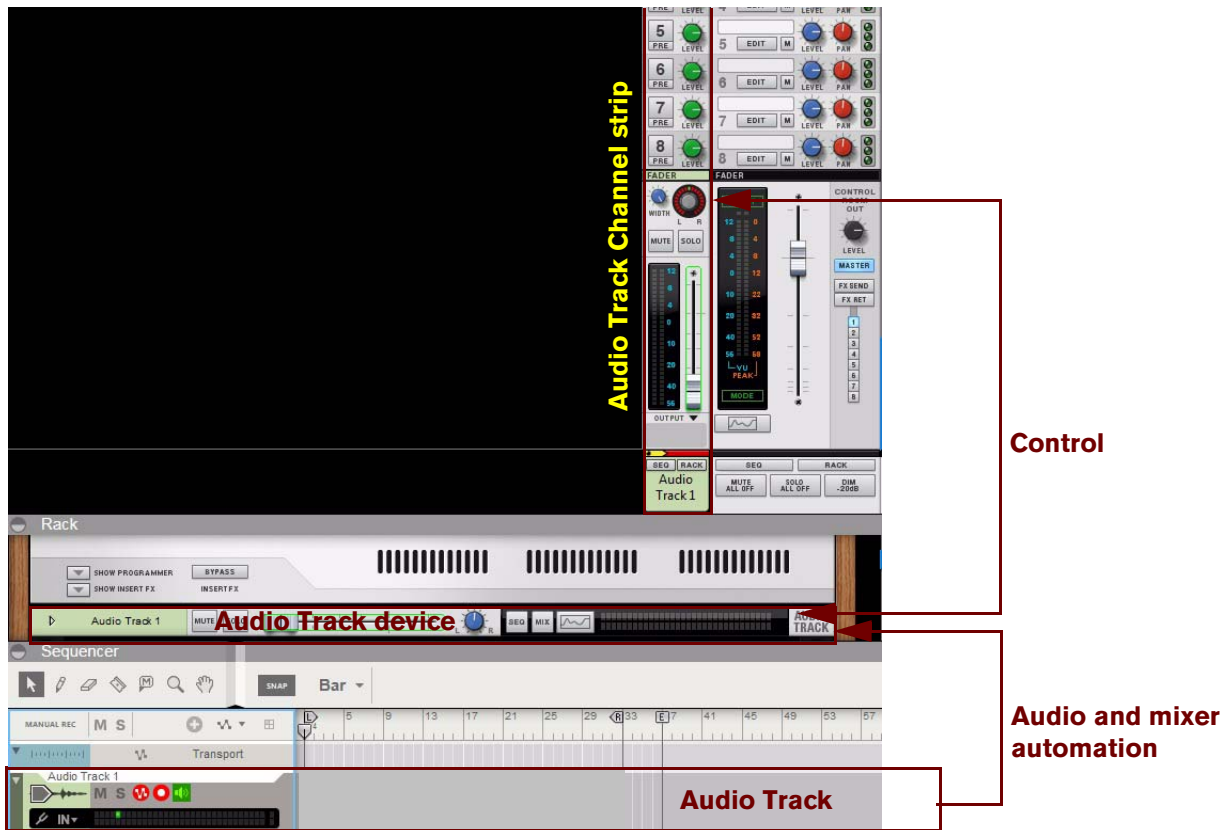

## Creating an instrument track

To create an instrument track, you need only create the instrument device. An instrument track is automatically created when you create a device which can receive MIDI notes:

**1. Drag and drop or double click the desired instrument device from the Instruments palette in the Browser.**

→ **Alternatively, select the desired instrument type from the “Create” menu.**

Alternatively, to select an Instrument patch and automatically load the patch into the appropriate device type, hold down [Ctrl](Win) or [Cmd](Mac) and press [I], or select “Create Instrument” from the “Create” menu to bring up the Patch Browser. Under Windows, you can also press [Insert] to open the Patch Browser. In the Patch Browser you can select and preview patches before loading them into the instrument.

**2. An instrument device is created in the rack and the associated track is automatically created in the sequencer.**

In addition, a Mix Channel device for the instrument is automatically created in the rack and its channel strip is created in the Main Mixer. All devices are automatically connected. The Mix Channel device automatically adapts its inputs to the created instrument type - if the instrument is in mono, the Mix Channel device will be in mono, and if the instrument has stereo outputs, the Mix Channel device will be in stereo.

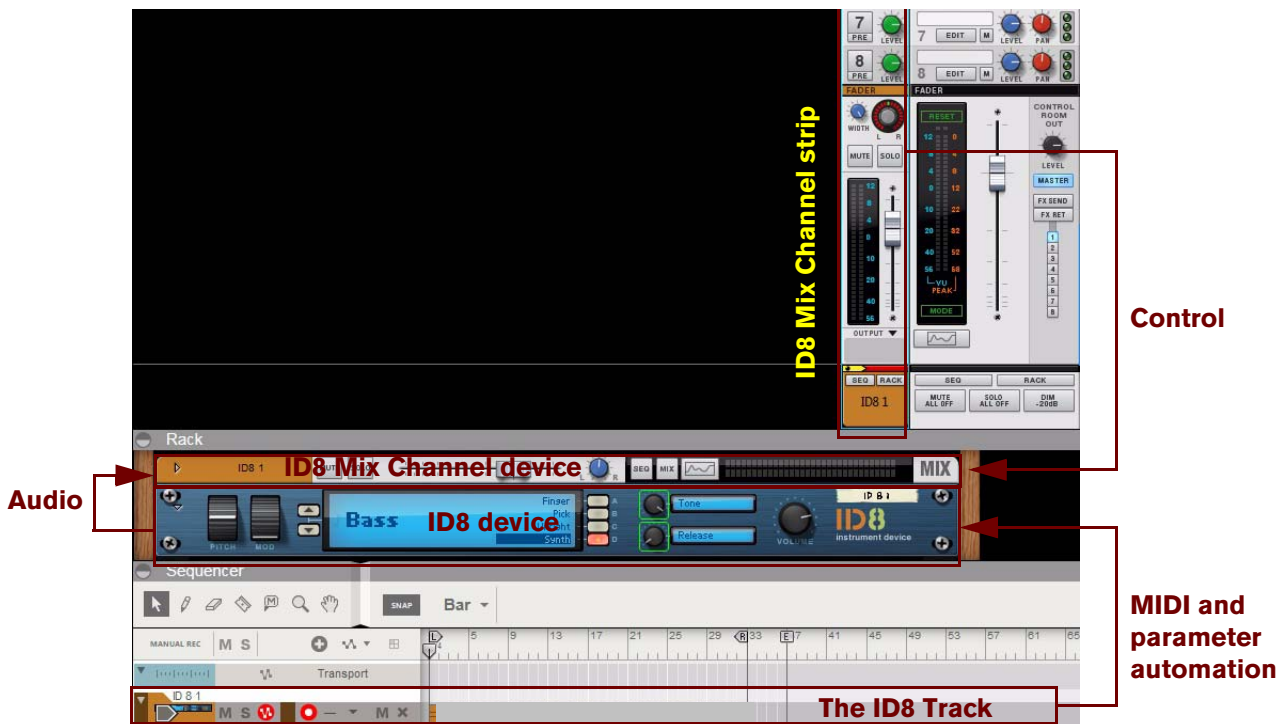

**! Note that no automation track is created for the Mix Channel device. This has to be manually created if you want to automate any of the Mix Channel strip parameters (see “Creating a parameter automation track for a non-instrument device”).**

→ **If you want to control an external MIDI instrument, create an External MIDI Instrument device from the “Create” menu or from the Instruments location in the Browser.**

An External MIDI Instrument device is created in the rack and the associated track is automatically created in the sequencer. See “External MIDI Instrument” for more details on how to configure the External MIDI Instrument device for controlling external MIDI instruments.

## Creating a parameter automation track for a non-instrument device

For non-instrument devices, such as effects devices and Mix Channel devices, you need to manually create a track if you want to record parameter automation. You can do that either by following the description below or by following either of the two last descriptions in ["Creating/adding parameter automation lanes"](#).

The track creation procedure described below also applies if you have manually deleted a track for an instrument device or an Audio Track device and want to create a new track for the device:

### 1. Select the device by clicking on it in the rack.



*A border around a device in the Rack indicates that it has been selected.*

### 2. Select "Create Track for ((patch) name of device)" from the Edit menu or the device context menu.

- ! **Note that if a track already exists for the device, this menu item will not be available - a device can only have one track.**
- **The new track will be automatically associated with the device and will get the same name as the device.**



- **Another way of creating a parameter automation track is by holding [Alt](Win) or [Option](Mac) and clicking on a parameter on the device panel. Alternatively, select "Edit Automation" from the parameter context menu.**
- **If you press [Alt](Win) or [Option](Mac) when you create a non-instrument device, this will automatically create an associated automation track for the device.**



## Short-cut for creating a Mix Channel track or Audio track

A faster way of creating a track for a Mix Channel device, or to create a new audio track (if you deleted the original one), is to go via the corresponding mixer channel strips in the Main Mixer:

1. **Scroll to the Main Mixer and locate the channel strip you want to create a track for.**



2. **[Shift]-click the SEQ (Goto Sequencer Track) button at the bottom of the channel strip.**

A new track will be automatically created in the sequencer for the selected channel strip.

- ! **If a track should already exist for the selected channel strip, [Shift]-clicking the SEQ (Goto Sequencer Track) button will only scroll the corresponding sequencer track into view, not create any new track.**

## Selecting tracks

- **Select a track by clicking on it in the Track List.**

A selected track gets a darker gray background color.



- Selecting a track in the sequencer will automatically scroll the corresponding device into view in the rack.
- **Selecting an audio track will set Edit Focus to its channel strip in the Main Mixer.**
- **Selecting another type of track (e.g. an instrument track) will set Edit Focus to the Mix Channel belonging to that device group.**  
See “About Device Groups” for information about device groups.
- **You can also select the next or previous track in the Track List list by using the up and down arrow keys on the computer keyboard.**
- ! **By default, selecting a track will automatically set Master Keyboard Input to that track. If you’d rather select tracks independent of the Master Keyboard Input selection, select “Separated” mode in the Preferences menu (“Keyboards and Control Surfaces” page). In “Separated” mode, you can select another track without automatically changing Master Keyboard Input. To change Master Keyboard Input, click the device icon on the desired track in the Track List.**
- **It is possible to select several tracks by using standard [Shift], or [Ctrl](Win) or [Cmd](Mac), selection techniques.**  
This allows you to e.g. move or delete several tracks in one go.

## Moving tracks

- **To move a track to another position in the Track List, click on the track handle (the leftmost area of the track) and drag the track up or down.**

A red insertion line is shown, indicating where the track will be placed after releasing the mouse button. All clips on all lanes of the track will be moved along with the track.



You can use the same technique to move several selected tracks at once. Use standard [Shift]-select or use [Ctrl](Win) or [Cmd](Mac) to select non-adjacent tracks.

## About sorting devices and channel strips according to the track order

Note that the order of the tracks in the sequencer Track List is totally independent from the device order in the rack - and from the channel strip order in the Main Mixer. However, it's possible to re-order devices and channel strips according to the track order in the Track List:

1. **Select the tracks in the Track List you want to re-order devices and channel strips after.**
2. **Select “Sort Selected Device Groups” from the Edit menu or from the track’s context menu.**

The associated devices and channel strips are now re-ordered, in the rack and Main Mixer respectively, according to the order of the selected tracks in the Track List.

- ! **Note that the re-ordering only affects the devices and channel strips of the selected tracks - all other devices and channel strips will remain unaffected.**

## Deleting tracks

The most common scenario would probably be to delete a track together with its associated device(s). However, it's also possible to delete only the track while keeping the associated device(s) in the rack.

### Deleting tracks together with their associated devices

- **To delete one or several tracks together with their associated devices in the Rack, select the tracks and then select “Delete Track(s) and Device(s)” from the Edit menu or from the track’s context menu. Alternatively, press [Delete] or [Backspace].**

An alert appears which prompts you to confirm or cancel the deletion of the track(s) and device(s).

- ! **If you're deleting the track for the Source Device or Mix Channel, and “Auto-group Devices and Tracks” on the Options menu is on, you will be asked if you want to delete the whole device group. If you hold down [Ctrl](Win) or [Cmd](Mac) while deleting, the whole device group will be deleted without the alert.**

See “[About Device Groups](#)” for more information about device groups.

### Deleting tracks only

- **To delete one or several tracks, select them and then select “Delete Track(s)” from the Edit menu or from the track’s context menu.**

The tracks will be deleted without an alert but you can always use the Undo function. See “[Undo and Redo](#)”.

**! If you delete an audio track, all recordings on that track will be removed!**

If you have deleted a track for a device and want to create a new track for the device, follow the descriptions in “[Creating a parameter automation track for a non-instrument device](#)” or “[Short-cut for creating a Mix Channel track or Audio track](#)”.

## Duplicating/copying tracks and devices

As it is not possible for a specific instance of a device to have more than one track, you cannot copy or duplicate only a track. These operations will instead duplicate/copy both the track (including all clips on the track) and its associated device(s) (with all settings). The duplicated/copied devices are really just like separate devices but with the same name and settings as the original devices, although their names will have the extension “Copy” to differentiate them from the original.

To make copies of tracks and their associated devices, complete with all lanes and recorded clips, use any of the following methods:

**! Note that if “Auto-group Devices and Tracks” on the Options menu is on, the entire device group(s) associated with the track(s) will be copied/duplicated when you perform the procedures described below.**

See “[About Device Groups](#)” for more information about device groups.

- **Hold down [Ctrl](Win) or [Option](Mac), click on the track handle and drag the selected track(s) to a new position in the track list.**
- **Select the track in the Track List, hold down [Ctrl](Win) or [Cmd](Mac) and press [D].**  
The duplicated track(s) will be inserted below the original track.
- **Select “Duplicate Device(s) and Track(s)” from the Edit menu or from the track’s context menu.**  
To bring up the context menu, right-click (Win) or [Ctrl]-click (Mac) on the track in the Track List. The duplicated track(s) will be inserted below the original track.
- **Select “Copy Device(s) and Track(s)” from the Edit menu or from the track’s context menu.**  
This allows you to insert the copied track(s) and device(s) by selecting “Paste” from the Edit menu or from the track’s context menu. The copied track(s) will be pasted below the currently selected track.
- ! Note that if “Auto-group Devices and Tracks” on the Options menu is off, duplicated/copied devices will not have auto-routed audio connections. To hear the duplicated devices, select the device and choose “Auto-route Device” on the Edit menu or context menu. Alternatively, flip the rack around and connect the audio outputs to available (or new) Mix Channel devices. You might also want to mute the original track to avoid double notes.**
- **To duplicate a selected audio track, with all recordings and mixer channel strip parameter settings, including any Insert FX, click the “Alt” or Dub” buttons on the Transport Panel - see “[Duplicating audio tracks using the “Alt” function](#)” and “[Overdubbing audio using the “Dub” function](#)”.**
- **If you hold down [Shift] and select Paste from the Edit menu or context menu, the copied device(s) will be auto-routed to an available mixer channel. If necessary, an additional Mix Channel will be automatically created.**

## Coloring tracks

A track can be assigned a color in the sequencer as follows:

- **To assign a new color to a selected track, select “Track Color” from the Edit menu or from the track’s context menu and then select color from the palette.**

The track color is shown in the track background in the Track List. The associated Audio Track device or Mix Channel device in the rack and its corresponding channel strip in the Main Mixer will also be assigned the new color. The selected track color will be reflected in all *new* clips you record or draw on this track.

- ! **If existing clips have the function “Use Track Color” active on the Clip context menu, these clips will also change color - otherwise they won’t. To manually change color of previously recorded clips, refer to “Coloring clips”.**

- **To automatically set a new color for new tracks, make sure the “Auto-color New Sequencer Tracks” box in the Options menu is ticked.**

The track color will be automatically selected from the palette when you create a new track.

## Naming tracks

Devices (and tracks) get the name of their loaded patch by default, but you can override this by manually renaming:

- **Name, or rename, a track by double-clicking its name tag in the Track List, typing in a name and pressing [Return].**

Note that naming/renaming a track also changes the name of the associated Source Device in the rack (and vice versa). Furthermore, renaming an audio track also changes the name of the associated Audio Track device in the rack as well as its corresponding channel strip in the Main Mixer. If you rename the track of a source device in a device group, its Mix Channel will get the same name. If you want a separate name for the Mix Channel, double-click in the Mix Channel name tag, in the rack or Main Mixer, type in a new name and press [Return].

See “About Device Groups” for more information about device groups.

## Folding tracks

To minimize the visible height of the track, and thus allow for a better overview of the tracks in the sequencer, it’s possible to fold tracks.

- **To fold/unfold a track, click on the small triangle on the track handle.**

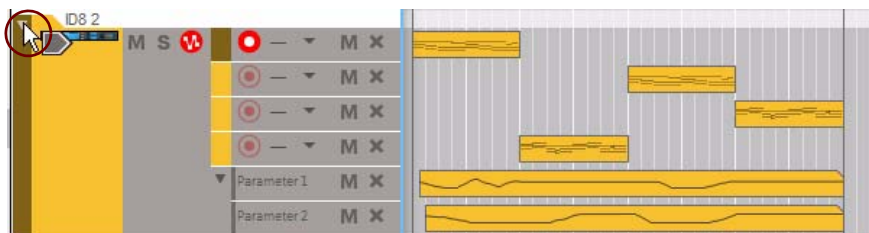

*An unfolded track.*



*The same track folded.*

A folded track will not show the individual lanes in the Track List, and on the Edit/Arrangement Pane the clips are shown as horizontal strips. If the folded track has several lanes, all the clips on the lanes will be shown as vertically stacked strips on the Arrangement Pane. No events in the clips are shown.

- **Basic clip operations (selecting, moving, copying etc.) are available also for folded tracks, although it is generally better to unfold a track if you want to edit its contents, as this gives you a better overview.**
- **To fold/unfold all tracks in the sequencer in one go, press [Alt](Win) or [Option](Mac) and click on a track handle triangle.**
- **It's also possible to fold/unfold only the parameter automation lanes on a track by clicking the triangle on the parameter automation tab. See “Parameter automation lane elements” for more details.**

## Muting tracks

To mute a track means to silence it, so that no data is sent from the track during playback. This can be useful when you are trying out different versions of an arrangement, for bringing elements in and out of the mix during playback.

**! Note that muting a sequencer track is NOT the same as muting a mixer channel (see “MUTE/SOLO buttons”).**

- **To mute a track, click the corresponding Mute (M) button in the Track List.**  
Everything present on the track will be muted.

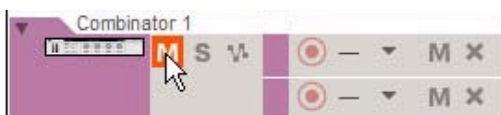

*A red “M” button in the Track List indicates that the track is muted.*

- **To unmute the track, click the “M” button again.**
- **Several tracks can have Mute active at the same time, in which case you can unmute them all by clicking the master “M” button at the top of the Track List.**

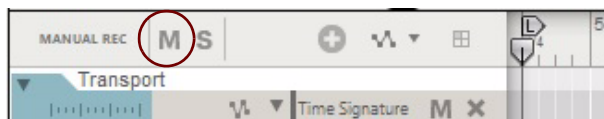

- **It's also possible to mute individual lanes and individual clips on a track. Refer to “Muting lanes” and “Muting clips”.**

## Soloing tracks

To solo a track means that all tracks in the sequencer, except for the soloed track, are muted.

**! Note that soloing a sequencer track is NOT the same as soloing a mixer channel (see “MUTE/SOLO buttons”).**

- **To solo a track, click the corresponding Solo (S) button in the Track List.**  
This mutes all other (un-soloed) tracks. Soloed tracks have green S buttons.



*Here, the “Filmscore Pad” track is soloed (indicated by the green “S” button).  
All other tracks are automatically muted (indicated by red “M” buttons).*

- **To turn solo off, click the green “S” button again.**
- **Several tracks can have Solo active at the same time, in which case you can turn off Solo for all of them by clicking the master “S” button at the top of the Track List.**



# Lane details

A track consists of one (default) or several parallel lanes. Depending on track type, the clips on the lanes can contain various types of events. A lane can also contain clips with performance controller and parameter automation events - or pattern selection for pattern based devices.

## Audio lane



The audio lane is not distinguished by a separate lane tab in the Track List like the other lane types. This is simply because an audio track can only have a single audio lane. Consequently, all audio lane elements reside in the audio track section instead.

## Audio lane elements



- **Record Enable button**  
To the right of the Record Enable Parameter Automation button is the Record Enable button. Make sure this button is on (red) before recording audio on the track. By default, this is activated when you select an audio track. If you want to record several audio tracks at the same time you need to click their Record Enable buttons first.
- **Monitor button**  
To the right of the Record Enable button is the Monitor button. Click this button to monitor the input signal of the track. The signal is monitored after the audio track channel strip which means that all channel strip parameters, including any Insert FX, Dynamics etc., will be monitored.
- ! **The Monitor button activation/deactivation depends on the setting in the “Monitoring” section on the “Audio” page in Preferences. If “Manual” is selected, you will have to manually activate the Monitor button. If “Automatic” is selected, the Monitor button is automatically activated when the Record Enable button is on.**
- **Enable Tuner button**  
To the left below the Device icon is the Enable Tuner button. Click the button to switch to Tuner mode. The Input Meter to the right will switch to a Tuner.



*Audio track in Tuner mode.*

In Tuner mode, you can tune a connected instrument - an electric guitar, for example. See [“Using the Tuner”](#) for more info.

- **Select Audio Input drop-down list**

To the right of the Tuner button is the Select Audio Input drop-down list. Here, you select which audio input(s) to use for the track. See “[Selecting audio input\(s\) and defining mono or stereo](#)” for more info.



- **Input Meter**

The Input Meter shows the level(s) of the input signal(s). If the selected audio input is mono, the Input Meter displays a single LED bar. If the audio input is in stereo, the Input Meter displays two parallel LED bars. See “[Setting input level\(s\)](#)” for details about setting input levels.

## Note lane



As the name implies, the note lane can contain clips that feature note events. Clips on a note lane can also contain performance controller events. One or several note lanes can be present on an instrument track.

### Note lane elements



- **Name**

At the top to the left is the name of the lane. As soon as you create a note lane it will automatically be named “Lane n” where “n” is the number of the lane - in chronological order. You can change the name of the lane by double-clicking in the name field, typing in a new name and then pressing [Return] on the computer keyboard.

- ! **Note that depending on the current magnification of the Edit/Arrangement Pane, the note lane names could sometimes be hidden. To make the note lane names visible, increase the vertical magnification of the Edit/Arrangement Pane, for example, by clicking the + magnification button below the sequencer Track Navigator.**

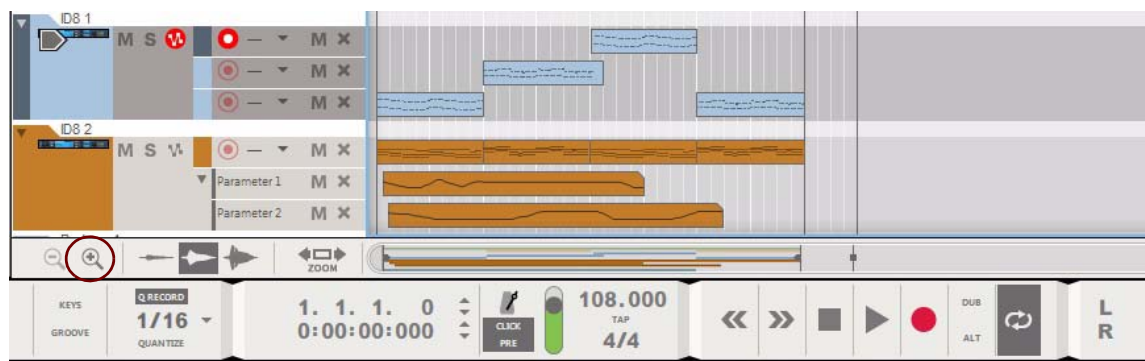

*Increase the vertical magnification by clicking the + magnification button below the Track List.*

- **Record Enable button**

Below the note lane name is the “Record Enable” button. Make sure this button is on (red) before recording on the lane. By default, the “Record Enable” button on the latest created/added note lane is automatically activated when you select an instrument track.

- **Groove Select drop-down list**

To the right of the “Record Enable” button is the “Groove Select” drop-down list. Here you can select a ReGroove channel for all clips on the lane. See more about ReGroove in [“The ReGroove Mixer”](#).

- **M (Mute) button**

Clicking the “M” button will mute the playback from the lane.

- **Delete (X) button**

To the far right is the “Delete Note Lane” (X) button. Clicking this button will delete the lane (and all clips on it). If there are clips on the lane, a dialog appears prompting you to confirm deletion.

## Parameter automation lane

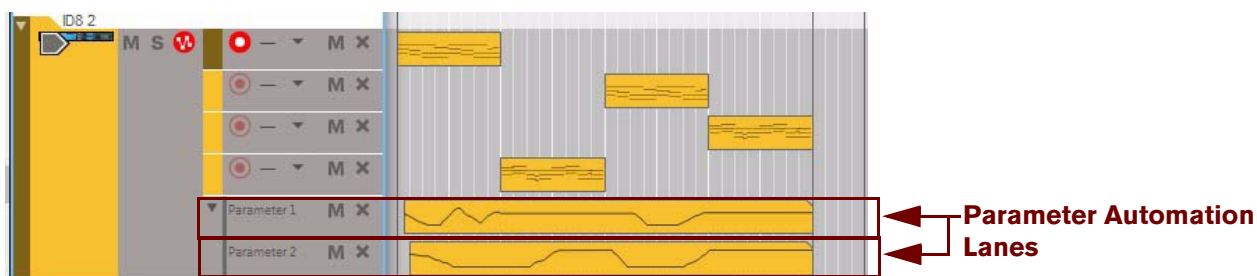

*An instrument track with two parameter automation lanes.*

Parameter automation is used for controlling changes of device parameter values in a song. You could, for example, automate a filter cutoff parameter and record filter sweeps at various positions in your song. These kind of parameter value changes are recorded on parameter automation lanes.

Parameter automation lanes can exist in all track types and can contain clips with device and/or channel strip parameter automation. A track can have as many automation lanes as its device has automatable parameters. For Mix Channel and Audio Track devices, parameter automation could be used for any of their corresponding channel strip controls.

## Parameter automation lane elements

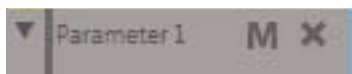

- **Fold/Unfold button**

Parameter automation lanes in a track can be folded/unfolded, as a group, by clicking the small triangle on the handle to the far left on the parameter automation lane tab.

→ **To fold/unfold all parameter automation lanes on all tracks in the sequencer, hold down [Alt](Win) or [Option](Mac) and click on the triangle on a parameter automation lane tab.**

- **Name**

The name of the automated parameter is displayed on the parameter automation lane tab. Since the name reflects the original device/channel strip parameter name, this cannot be changed.



- **M (Mute) button**

Clicking the “M” button will mute the parameter automation playback from the lane. Muting a parameter automation lane will freeze whatever value the parameter had when you muted the lane. Deactivating the Mute button reactivates the automation.

- **Delete Automation Lane (X) button**

To the far right is the “Delete Automation Lane” (X) button. Clicking this button will delete the lane (and all clips on it). If there are clips on the lane, a dialog appears prompting you to confirm deletion. See [“Deleting parameter automation lanes”](#) for alternative ways of deleting parameter automation lanes.

## Pattern lane

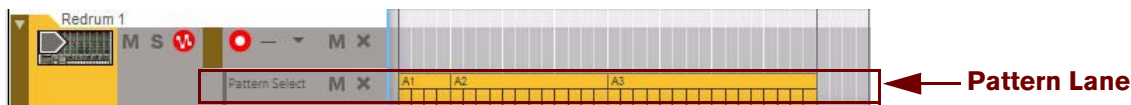

*A Redrum track featuring a pattern lane.*

A pattern lane can only exist in a track featuring a pattern based device, such as the Redrum Drum Module or the Matrix Analog Pattern Sequencer. A pattern lane can only contain clips with pattern Bank and pattern Number automation data. There can only be a single pattern lane per track.

### Pattern lane elements



- **Name**

The name of the automated parameter is displayed on the pattern automation lane tab. Since the name reflects the original device parameter name, this cannot be changed.

- **M (Mute) button**

Clicking the “M” button will mute the pattern automation playback from the lane. Muting a pattern automation lane will freeze whatever value the parameter had when you muted the lane. Deactivating the Mute button reactivates the pattern automation.

- **Delete Pattern Lane (X) button**

To the far right is the “Delete Pattern Lane” (X) button. Clicking this button will delete the lane (and all clips on it). If there are clips on the lane, a dialog appears prompting you to confirm deletion. See [“Deleting pattern lanes”](#) for alternative ways of deleting pattern lanes.

# Creating/adding lanes

## Adding note lanes

You can add additional note lanes on an instrument track. This can be useful under the following circumstances:

- **If you want to overdub notes or performance automation but don't want to record in existing clips.**
- **If you want to record a series of takes on separate note lanes, to later decide which take is the "best" (or to edit together a composite).**
- **If you want to apply different ReGroove grooves to different parts of a track, or want different grooves on separate drums on a drum track.**

You can create new note lanes for selected instrument tracks in the following ways:

- **Select "New Note Lane" from the Edit menu or from the context menu.**  
A new note lane will be created and automatically record enabled.
- **Click on the "New Note Lane" (Lanes +) button at the top of the Track List.**

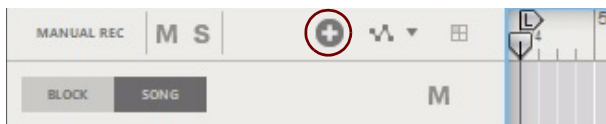

A new Note Lane will be created and automatically record enabled.

- **Click on the "Dub" button on the Transport Panel.**

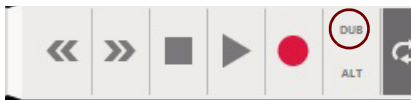

A new note lane will be created and automatically record enabled. See ["Recording notes using the "Dub" and "Alt" functions"](#) for more details.

- **Click on the "Alt" button on the Transport Panel.**

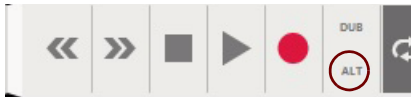

A new note lane will be created and automatically record enabled. At the same time, the previous note lane, or (if loop is activated and the Song Position Pointer is between the Left and Right Locators) the clips between the Left and Right Locators, will be muted. See ["Recording notes using the "Dub" and "Alt" functions"](#) for more details.

- **Note that the "Dub" and "Alt" functions can also be used on-the-fly during recording without stopping the sequencer.**

## Creating/adding parameter automation lanes

Parameter automation lanes can be created for all track types.

- **During recording of a track, changing any parameter values on the device/channels strip will automatically create a new parameter automation lane for each unique parameter. See “Recording parameter automation” for more details.**

Do as follows to manually create a parameter automation lane on a selected track:

- **Hold down [Alt](Win) or [Option](Mac) and click on a device parameter in the rack, or on a channel strip parameter in the Main Mixer. Alternatively, select “Edit Automation” from the parameter’s context menu.**

A new parameter automation lane will be automatically created in the track for the corresponding device or channel strip. The automated parameter on the device in the rack or channel strip in the Main Mixer will get a green border, indicating that it has been automated.

- ! **Note that if a track hasn’t already been created for the device/channel strip, it will be automatically created during this operation.**

Other ways of creating/adding a parameter automation lane are as follows:

1. **Click on the “Track Parameter Automation” drop-down list at the top of the Track List.**

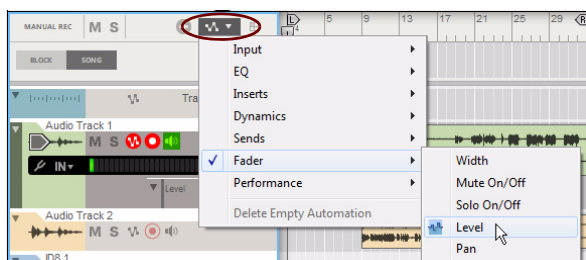

2. **Select the parameter you want to automate from the list.**

A new parameter automation lane is automatically created on the selected track.

If you click the Track Parameter Automation drop-down list again, any selected parameters will have a symbol to the left of the parameter name, indicating that an automation lane already exists for the parameter.

The automated parameters on the device in the rack or channel strip in the Main Mixer will get green borders, indicating that they have been automated.

## Creating a pattern lane

For pattern based devices such as the Redrum Drum Module and Matrix Analog Pattern Sequencer, a single pattern lane can be created on a selected track. Do either of the following:

- **Click the “Create Pattern Lane” button at the top right of the Track List.**

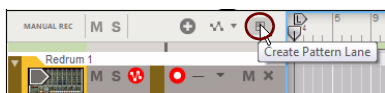

- **Select “Create Pattern Lane” from the Edit menu or from the context menu.**
- **Hold down [Alt](Win) or [Option](Mac) and click on the “Pattern” button section of the device in the rack.**
- **Right-click (Win) or [Ctrl]-click (Mac) on the “Pattern” button section of the device in the rack and select “Edit Automation” from the context menu.**

When you create a pattern lane, the bank buttons on the device in the rack get a green border to indicate that they have been automated.

- **Clicking the Pattern and/or Bank buttons on the device during recording will automatically create a pattern lane. See “Recording pattern automation” for more details.**

# Deleting lanes

## Deleting note lanes

A note lane can be deleted as follows:

- **Click the “Delete Note Lane” (X) button on the lane tab in the Track List.**

This will delete the lane (and all clips on it). If there are clips on the lane, a dialog appears prompting you to confirm deletion.



- **To delete the lane without the dialog, hold down [Ctrl](Win) or [Cmd](Mac) and click the Delete Note Lane button.**

## Deleting parameter automation lanes

There are a number of different ways of deleting a parameter automation lane:

- **Click the “Delete Automation Lane” (X) button on the lane tab in the Track List.**

This will delete the lane (and all clips on it). If there are clips on the lane, a dialog appears prompting you to confirm deletion.

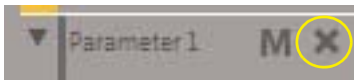

- **To delete the lane without the dialog, hold down [Ctrl](Win) or [Cmd](Mac) and click the Delete Automation Lane button.**

Another way is this:

- **Right-click (Win) or [Ctrl]-click (Mac) on the automated device parameter in the rack and select “Clear Automation” from the context menu.**

The green border around the device parameter disappears and the corresponding parameter automation lane is deleted from the track.

Alternatively, do the following:

- Select a track by clicking on it.**
- Click on the “Track Parameter Automation” drop-down list at the top of the Track List.**

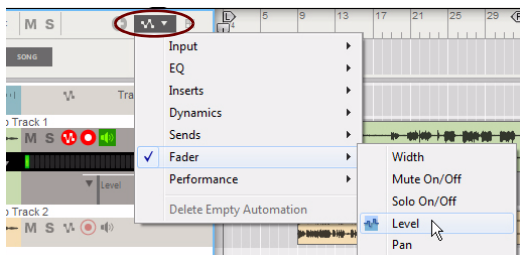

- De-select the parameter you want to delete from the list.**

All selected parameters will have a symbol to the left of the parameter name in the list indicating that it has been selected. Selecting a parameter with a symbol in the list will automatically delete the corresponding lane, with its clips, from the track. If there are clips on the lane, a dialog appears prompting you to confirm deletion.

The green borders that surrounded the automated parameters on the device/channels strip will also be removed.

## Deleting pattern lanes

There are two ways of deleting a pattern lane:

- **Click the “Delete Pattern Lane” (X) button on the lane tab in the Track List.**

This will delete the lane (and all clips on it). If there are clips on the lane, a dialog appears prompting you to confirm deletion.



- **To delete the lane without the dialog, hold down [Ctrl](Win) or [Cmd](Mac) and click the Delete Pattern Lane button.**

Alternatively:

- **Right-click (Win) or [Ctrl]-click (Mac) on the automated pattern section on the device in the rack and select “Clear Automation” from the context menu.**

The green border around the device pattern section disappears and the corresponding pattern lane is deleted from the track.

## Moving note lanes

A note lane has a “handle” and can be moved vertically together with all clips on the lane. Move a note lane to another position on the same track like this:

- 1. Click on the lane handle (the leftmost area of the lane).**

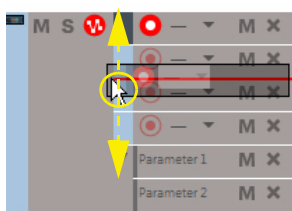

- 2. Drag the note lane up or down and release at the desired destination.**

Just as when moving tracks, a red insertion line is shown indicating where the note lane will be placed after you release the mouse button.

- **It is also possible to move note lanes, with their clips, between tracks.**
- ! **Parameter automation lanes and pattern lanes cannot be moved since they are tightly connected with their associated devices. However, you can move or copy clips from one lane to another.**

## Copying (duplicating) note lanes

You can copy (duplicate) one note lane at a time, together with its clips, by doing the following:

- 1. While pressing [Ctrl](Win) or [Option](Mac), click and drag a copy of the note lane to the desired destination.**

The cursor gets a + sign next to it to indicate duplication. The destination of the duplicated note lane could be the same track or another track.

- 2. Release the mouse button.**

- ! **Parameter automation lanes and pattern lanes cannot be duplicated.**

# Muting lanes

## Muting a note lane

→ To mute a note lane, click its “M” (Mute) button.



The note lane’s “M” (Mute) button.

## Muting a parameter automation lane

→ To mute a parameter automation lane, click its “M” (Mute) button.

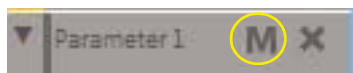

The parameter automation lane’s “M” (Mute) button.

# Clip basics

Only the basic properties and functions pertaining to clips are described here. See “Arranging in the Sequencer” for in-depth details about what you can do with clips.

## Clip types

Here are the different clip types:

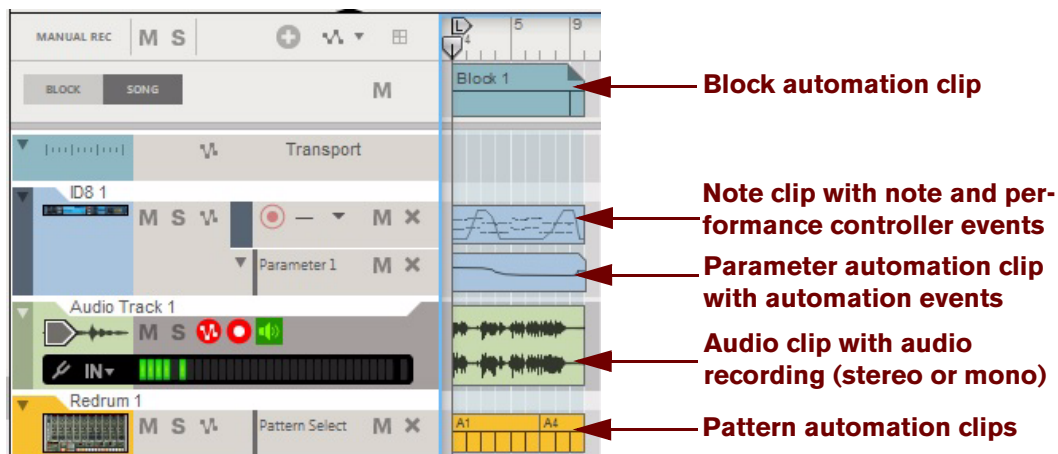

- **Block automation clips (only if Blocks are on) that contain information of which Block should play back.**
- **Note clips contain note events with velocity values. Note clips can also contain performance controller events.**
- **Parameter automation clips contain events for an automated device/channel strip parameter.**  
A parameter automation clip can easily be distinguished by the shape of its frame: the top right corner is “cut off”.
- **Audio clips contain mono or stereo audio recordings.**  
If the audio clip is a Comp clip, or a Single Take clip which contains several takes, there is a small symbol in the lower right corner of the clip.
- **Pattern automation clips contain device bank+pattern number.**

# Toolbar details

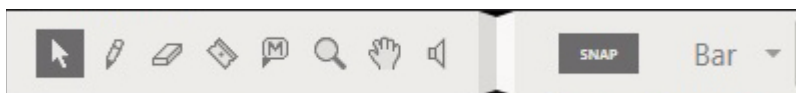

The Sequencer Toolbar can be found to the top left in the Sequencer Area. From the Sequencer Toolbar you can select various sequencer editing tools.

## Toolbar tools

### Selection Tool



The Selection (arrow) Tool is the main tool for selecting and moving tracks, note lanes, clips and events and recordings in clips. It's also used for resizing clips and events in clips. It is selected by default when a song is opened.

- You can also select the Selection Tool by pressing [Q] on the computer keyboard.
- Press [Alt](Win) or [Cmd](Mac) to momentarily switch from the Selection Tool to the Pencil Tool - or to the Speaker Tool when editing an open audio clip inline - or to the Cut (Razor) Tool when editing an open audio clip in the Comp Editor.

### Pencil Tool



The Pencil Tool is used for manually drawing clips and events in clips. It can also be used to edit the velocity values of notes in open note clips.

- You can also select the Pencil Tool by pressing [W] on the computer keyboard.
- Press [Alt](Win) or [Cmd](Mac) to momentarily switch from the Pencil Tool to the Selection Tool.

### Eraser Tool



The Eraser Tool is used for deleting clips and events.

- You can also select the Eraser Tool by pressing [E] on the computer keyboard.
- Press [Alt](Win) or [Cmd](Mac) to momentarily switch from the Eraser Tool to the Pencil Tool.

### Razor Tool



The Razor Tool is used for splitting clips - and for creating cuts when comping audio clips in Edit Mode.

- You can also select the Razor Tool by pressing [R] on the computer keyboard.
- Press [Alt](Win) or [Cmd](Mac) to momentarily switch from the Razor Tool to the Pencil Tool - or to the Selection Tool when editing an open audio clip on the Edit Pane.

## Mute Tool



The Mute Tool is used for muting clips in the arrangement - or lanes in Block automation clips (see “Muting lanes in Block Automation Clips”).

- You can also select the Mute Tool by pressing [T] on the computer keyboard.
- Press [Alt](Win) or [Cmd](Mac) to momentarily switch from the Mute Tool to the Razor Tool.

## Magnifying Glass Tool



The Magnifying Glass Tool lets you zoom in and out both horizontally and vertically on the Arrangement Pane. The Magnifying Glass Tool offers a couple of possibilities:

- **To zoom in with the Magnifying Glass Tool, click in the Arrangement Pane where you want the origin of magnification.**

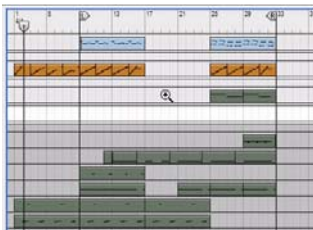

Place the Magnifying Glass Tool in the Arrangement Pane and click.

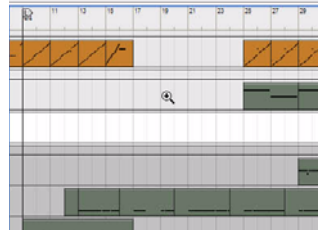

After three clicks, the Arrangement Pane looks like this. The magnification is equal in vertical and horizontal directions.

- **To zoom out with the Magnifying Glass Tool, hold down [Ctrl](Win) or [Option](Mac) and click.** You'll notice that the “+” sign in the Magnifying Glass Tool changes to a “-” sign.

- **You can also click and drag with the Magnifying Glass Tool to create a selection rectangle.** The view will then be zoomed in so that the selected area fills the entire Arrangement Pane.

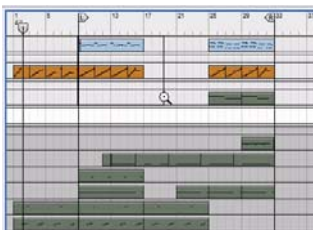

Place the Magnifying Glass Tool on the Arrangement Pane, click and drag to create a selection.

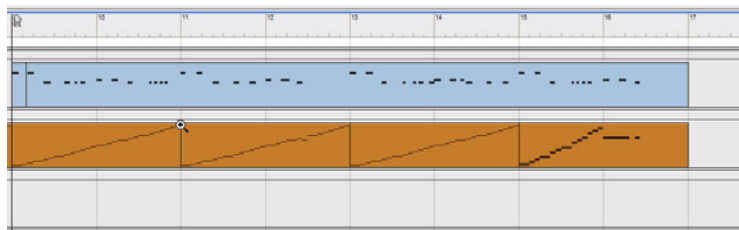

After releasing the mouse button, the zoomed selection fills up the Arrangement Pane. The magnification can be different in vertical and horizontal directions depending on the shape of the selection rectangle.



- You can also select the Magnifying Glass Tool by pressing [Y] on the computer keyboard.
- Press [Alt](Win) or [Cmd](Mac) to momentarily switch from the Magnifying Glass Tool to the Hand Tool.
- It's also possible to zoom in the Arrangement Pane by using the Sequencer Area Navigators and Zoom To Selection function as described in ["Zooming in the Sequencer"](#) and ["Zooming to selection"](#).

## Hand Tool



The Hand Tool is used for scrolling in the Edit/Arrangement Pane.

- Select the Hand Tool and click anywhere in the Edit/Arrangement Pane, keep the mouse button depressed and drag to desired view.

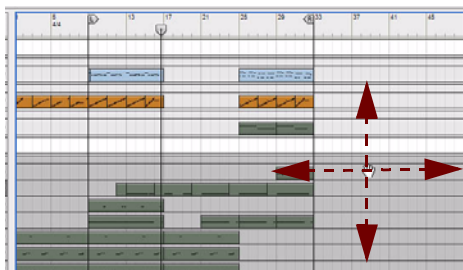

- You can also select the Hand tool by pressing [U] on the computer keyboard.
- Press [Alt](Win) or [Cmd](Mac) to momentarily switch from the Hand Tool to the + Magnifying Glass Tool.
- Press [Ctrl]+[Alt](Win) or [Cmd]+[Option](Mac) to momentarily switch from the Hand Tool to the - Magnifying Glass Tool.
- It's also possible to scroll in the Edit/Arrangement Pane by using the Sequencer Area Navigators as described in ["Scrolling with the Navigators and scrollbars"](#).

## Speaker Tool



The Speaker Tool is used for auditioning slices in Single Take audio clips, and for auditioning individual recordings on Comp Rows in Comp Clips. See ["Inline audio editing tools"](#) and ["Comp Editor audio editing tools"](#) for details.

## Alternate tools

For every tool mode described earlier, there is a so called alternate tool that can be momentarily selected by holding down [Alt](Win) or [Cmd](Mac) on the computer keyboard. Below is a summary of the alternate tools:

Selected tool	Alternate tool
Selection tool	Pencil tool (Speaker tool in inline editing of Audio Track or Cut (Razor) tool when editing audio clip in Comp Editor)
Pencil tool	Selection tool
Eraser tool	Pencil tool
Razor tool	Pencil tool (Selection tool when editing open audio clip on the Edit Pane)

Selected tool	Alternate tool
Mute tool	Razor tool
Magnifying Glass tool	Hand tool
Hand tool	+ Magnifying Glass tool
Hand tool	- Magnifying Glass tool by pressing [Alt]-[Ctrl](Win) or [Option]-[Cmd](Mac)

## Snap



The Snap function in the sequencer toolbar is used for “restricting” editing of clips and events to a user-selectable note value grid. When moving clips or events, the Snap function always works relative to the original position(s) of the clip(s) or event(s).

→ **Select the grid you wish to snap to by selecting the note value from the drop-down list:**

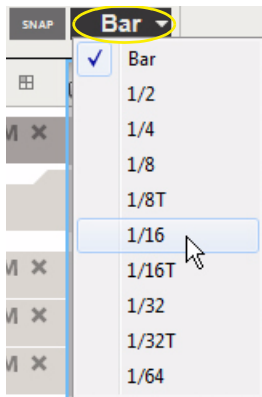

→ **Activate the Snap function by pressing [S], or by clicking the Snap button:**



! **Note that you can select different Snap values for selected clips and for open clips (see “[About separate Snap values for selected clips and for open clips](#)”).**

The Snap function effects the following operations:

- **Moving the Song Position Pointer, Loop Locators and Song End Marker.**  
When you adjust the Locators with Snap activated, they will snap to the selected Snap value on an absolute grid.
- **Moving clips and events, recordings and Comp Row cuts.**  
When you move objects with Snap activated, they will keep their relative distance to the Snap value positions.
- **Drawing clips.**  
When you create clips with the Pencil tool, their start and end positions will snap to the selected note value positions on an absolute grid.
- **Drawing events in open clips.**  
The Snap value determines the absolute grid points on which you can draw a note or an automation point. The Snap value also determines the shortest possible note length that you can draw.
- **Splitting clips with the Razor tool.**  
The Snap value determines the absolute grid to which a clip can be split.

- **Nudging clips, events and recording.**

When you nudge clips, events or recordings with Snap activated, they will keep their relative distance to the Snap value positions.

- **Creating Comp Row cuts**

The Snap value determines the absolute grid to which you could add cuts in open Comp audio clips.

- **Creating and Moving Slice Markers**

The Snap value determines the absolute grid to which you could add and move Slice Markers in open Single Take audio clips.

## About separate Snap values for selected clips and for open clips

There are two different Snap settings, one for when a clip is open for editing in Edit Mode, and one for when no clip is open (e.g. in Song/Block View). Typically, you would set a fine Snap value (e.g. 1/16) for open clips in Edit Mode and have the other Snap value set to "Bar" for convenient clip arranging in the Song/Block View. You can also choose to turn Snap off in either of these modes, independently of the other setting.

- **The Snap value for editing is used whenever a note clip or automation clip is open (including when an automation clip is opened in Arrange Mode).**

However, there's one exception: If a note clip is open in Edit Mode and you click in the Clip Overview (see "Edit Mode elements"), the clip will remain open but the Snap value for arranging will be selected. This allows you to e.g. move or resize the clip in the Clip Overview just like in the Song/Blocks View, without closing it first.

## Sequencer Toolbar keyboard shortcuts

Below is a complete list of the computer keyboard shortcuts for selecting tools on the sequencer Toolbar:

Function	Key command
Selection tool select	[O]
Pencil tool select	[W]
Eraser tool select	[E]
Razor tool select	[R]
Mute tool select	[T]
Magnifying Glass tool select	[Y]
Hand tool select	[U]
Snap On/Off	[S]

## Ruler details

The Ruler is the song's time line. In the Ruler, the Song Position Pointer indicates the current position in the song, i.e. in which bar the song is, or will start, playing. The Ruler also shows the Left (L) and Right (R) Loop Locators as well as the Song End Marker (E).

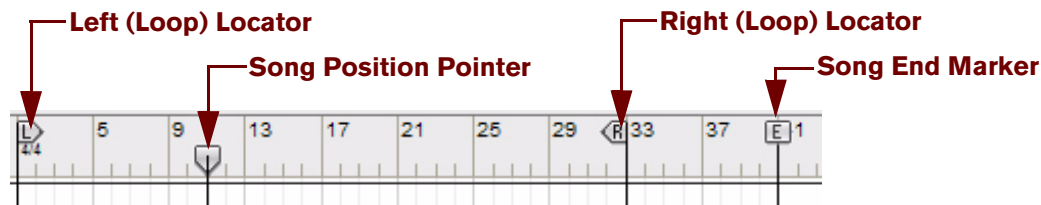

You can change the positions of the Song Position Pointer, Locators and Marker in the Ruler by clicking and dragging them to desired positions in the Ruler. Note that you have to click and drag the “flags” in the Ruler - not the lines. The Song Position Pointer and Loop Locators can also be moved by typing in new positions in the respective Position displays in the Sequencer Transport Panel (see “[Song Position](#)” and “[Left and Right Locator Positions](#)”). Another way of moving the Song Position Pointer is by using the Rewind and Fast Forward controls on the sequencer Transport Panel (see “[Rewind and Fast Forward](#)”).

## Transport Panel details

At the bottom of the Reason window is the sequencer's Transport Panel. From here you control the sequencer transport functions. You can also set tempo, time signature and various other parameters.

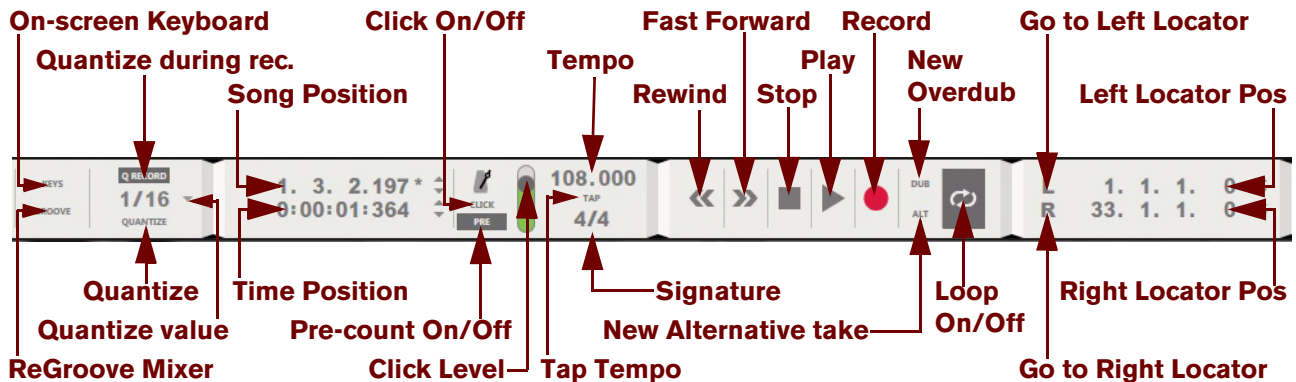

### Keys

- Click this button to bring up the **On-screen Piano Keyboard floating window**. See the “[On-screen Piano Keys](#)” chapter for more information.

### Groove

- Click the **Groove** button to bring up the **ReGroove Mixer**. Refer to “[The ReGroove Mixer](#)” chapter for more information.

### Q Record

- Click the **Q Record (Quantize during recording)** button to **quantize notes as they are being recorded**. When the Q Record button is on, all recorded MIDI notes will be quantized to the currently selected quantization grid. Refer to “[Quantize](#)” for more information on quantization.

### Quantize value

- **Select the desired quantization value from the drop down list**. Refer to “[Quantize](#)” for more information on quantization.

### Quantize

- Click the **Quantize** button to **quantize the notes in the selected clips to the selected Quantize value - after they have been recorded**. Refer to “[Quantize](#)” for more information on quantization.

## Song Position

The current song position is shown in the display. The song position is where the Song Position Pointer in the Ruler (see [Ruler details](#)) is at the moment. The display is divided into Bars, Beats, 1/16th Note and Ticks (there are 240 Ticks for each 16th note) segments. You can edit the position of the Song Position Pointer, and thus change the song playback position, according to the descriptions in ["Transport Panel segment displays"](#).

### About subticks in the Song Position display

When editing notes and automation events in the sequencer you have a resolution of 240 ticks per 1/16th note, which allows for very accurate positioning. But for the Song Position Pointer, the internal resolution is even higher (15360 ppq) which means that the position can end up on a fraction of a tick, a so called subtick.

If the Song Position Pointer value is on a fraction of a tick, this is displayed with an asterisk (\*) in the Tick section of the Song Position display.

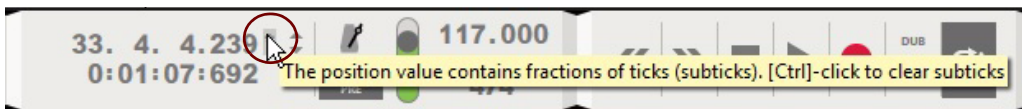

- **To adjust the Song Position Pointer to the closest tick value, press [Ctrl](Win) or [Cmd](Mac) and click on the asterisk in the display.**

The Song Position Pointer will now adjust to the closest tick value and the asterisk disappears.

## Time Position

The current position of the Song Position Pointer in the Ruler (see [Ruler details](#)) is shown in time format (hours, minutes, seconds and milliseconds) in the display. You can change the position in time of the Song Position Pointer, and thus change the song playback time position, according to the descriptions in ["Transport Panel segment displays"](#).

### Click On/Off

- **Click this button to hear an audible metronome click as the sequencer plays.**

The click will sound on every beat, with the first beat in every bar accented (higher pitched). See ["Click and Pre-count"](#) for more details.

### Pre(-count) On/Off

- **Click the Pre button to hear a pre-count (count-in) click sound before recording.**

Pre-count will only be present before recording - not before regular playback. See ["Click and Pre-count"](#) for details about selecting number of pre-count bars etc.

### Click Level

- **Adjust the audio level of the metronome (and Pre-count) with this slider.**

See ["Click and Pre-count"](#) for more details.

## Tempo

The current song tempo is shown in the display in BPM (Beats Per Minute) and 1/1000 of a BPM. You can edit the tempo according to the descriptions in ["Transport Panel segment displays"](#). The Tempo range is 1.000-999.999 BPM.

## Tap Tempo

Instead of setting the Tempo with the Tempo control (see above), you can manually tap in the desired tempo in real-time.

### → Click the Tap button repeatedly to set desired sequencer tempo.

The tempo is defined by averaging the time between a minimum of two clicks and a maximum of 16 clicks. The more clicks, the more “steady” the tempo. The time-out between two series of clicks is 2 seconds. The detectable tap tempo range is 30-999.999 BPM.

## Signature

The current song time signature is shown in the display. You can edit the time signature according to the descriptions in [“Transport Panel segment displays”](#).

The available Signatures are: 1/2-16/2, 1/4-16/4, 1/8-16/8 and 1/16-16/16.

## Rewind and Fast Forward

### → Click on the Rewind or Fast Forward buttons to move the Song Position Pointer in steps of one bar (from its current position).

### → To move the Song Position Pointer several bars at once, click and hold the mouse button depressed.

Instead of clicking the buttons, you can use the computer keyboard:

### → Press [4] on the numeric keypad for Rewind and [5] for Fast Forward.

### → If you click and hold the Rewind or Fast Forward buttons, or press and hold the [4] or [5] keys, the positioning speed will be faster after the first 20 bars.

## Play and Stop

### → Click the Play button to start playback from the Song Position Pointer’s current position.

### → Alternatively, press [Enter] on the numeric keypad on the computer keyboard.

### → Click the Stop button to stop playback (or recording).

### → Alternatively, press [0] on the numeric keypad or [Shift]+[Return] on the computer keyboard.

If you click the Stop button, or use the keyboard “Stop” commands, when the song is already stopped, the Song Position Pointer is moved according to the following rules:

### • Clicking/pressing Stop the first time moves the Song Position Pointer to where playback was last started.

### • Clicking/pressing Stop a second time moves the Song Position Pointer to the beginning of the song.

### • If the Song Position Pointer already is at the beginning of the song, nothing happens.

This means you can always click twice on the Stop button in “stop mode”, to return to the beginning of the song.

### → Press [Spacebar] on the computer keyboard to toggle between Play and Stop.

## Record

### → Click the Record button to begin recording on the selected track/lane in your song.

Alternatively, press [\*] on the numeric keypad or hold down [Ctrl](Win) or [Cmd](Mac) and press [Return] on the computer keyboard. If Pre-count has been activated (see [Pre\(-count\) On/Off](#) above), the recording will begin after the set number of pre-count bars.

### ! Nothing you play during the pre-count period will be recorded.

## Dub and Alt

Clicking on any of these buttons will add additional audio tracks or note lanes for overdub purposes. Refer to [“Overdubbing audio using the “Dub” function”](#) and [“Recording notes using the “Dub” and “Alt” functions”](#) for more details about these functions.

## Loop On/Off

→ **Click the Loop button or press [L] to activate the Loop function.**

When the loop function is activated, recording and playback will be continuously looped between the Left and Right Locators. Some general rules regarding loop mode are these:

- **If the Song Position Pointer is to the left of (before) the Right Locator when playback is started, the song will play to the Right Locator and then immediately jump back and seamlessly continue from the Left Locator.**
- **If the Song Position Pointer is to the right of (after) the Right Locator when playback is started, the Locators will be ignored and the song will continue to play “un-looped”.**
- **If the Left Locator is to the right of the Right Locator, i.e. in “reversed” order, the song will play to the Right Locator and then immediately jump and seamlessly continue from the Left Locator, skipping the part of the song in-between the Locators. The song will then continue to play “un-looped”.**

## Go to Left and Right Locators

- **Click on the “L” or “R” button to move the Song Position Pointer to the Left or Right Locators respectively.**
- **Alternatively, press [1] on the numeric keypad on the computer keyboard to move the Song Position Pointer to the Left Locator or [2] to move to the Right Locator.**

## Left and Right Locator Positions

The current positions of the Left and Right Locators in the Ruler (see [Ruler details](#)) are shown in the displays. The display is divided into Bar, Beat, 1/16th Note and Ticks (there are 240 Ticks for each 1/16th Note). You can change the positions of the Locators, and thus change the loop playback region, according to the descriptions in [“Transport Panel segment displays”](#).

## Transport keyboard commands

Below is a complete list of the computer keyboard shortcuts for the Sequencer Transport functions:

Function	Key command
Stop, Go to start position, Go to start of song	[0] on the numeric keypad or [Shift]+[Return]
Play	[Enter] on the numeric keypad
Toggle Stop/Play	[Spacebar]
Rewind	[4] on the numeric keypad
Fast Forward	[5] on the numeric keypad
Record	[*] on the numeric keypad or [Ctrl](Win) or [Cmd](Mac)+[Return]
Go to Left Locator	[1] on the numeric keypad
Go to Right Locator	[2] on the numeric keypad
Go to the start of the song	[.] on the numeric keypad
Move forward one bar	[8] on the numeric keypad
Go back one bar	[7] on the numeric keypad
Tempo up	[+] on the numeric keypad

Function	Key command
Tempo down	[-] on the numeric keypad
Loop On/Off	[/] on the numeric keypad or [L]
Click On/Off	[C] or [9] on the numeric keypad
Pre-count On/Off	[Ctrl](Win) or [Cmd](Mac)+[P]
Set the Left and Right Loop Locators to encompass selected clips.	[Ctrl](Win) or [Cmd](Mac)+[L]
Set the Left and Right Loop Locators to encompass selected clips and start playback in Loop Mode.	[P]

**! If you are using ReWire for remote controlling Reason, the transport functions can be handled by either application. See “ReWire” for details.**



# About the Inspector

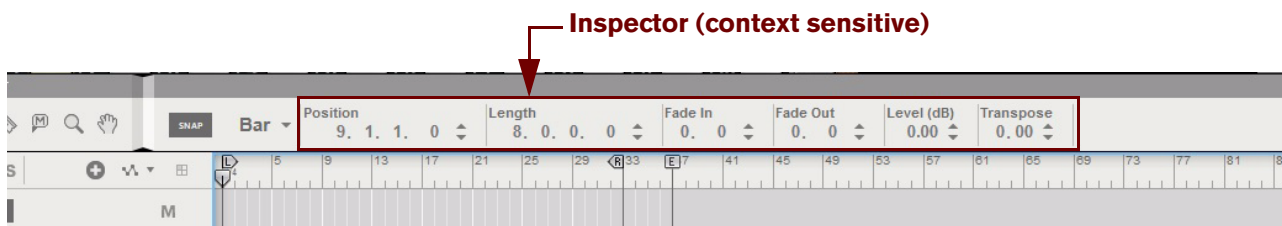

The Inspector, located above the Edit/Arrangement Pane, can be used for a number of different editing purposes pertaining to clips, events and recordings. The Inspector is context sensitive, meaning it will have different content and functionality depending on what is currently selected. How to edit using the Inspector is described in detail in the sections “Resizing clips using the Inspector”, “Moving clips using the Inspector”, “Editing recordings and cuts in the Inspector” and “Editing notes and events in the Inspector”.

! **When the Pencil Tool is selected, the Inspector isn't visible. Instead, menus pertaining to Time Signature, Pattern Automation and Blocks Automation are displayed.**

## About subticks in the Position and Length displays

When editing notes and automation events in the sequencer you have a resolution of 960 ppq (240 ticks per 1/16th note), which allows for very accurate positioning. But when you record, the internal resolution is even higher (15360 ppq) which means that notes and automation events can end up on a fraction of a tick, a so called subtick.

If the value is a fraction of a tick, this is displayed with an asterisk (\*) in the Tick section of the Position or Length display.

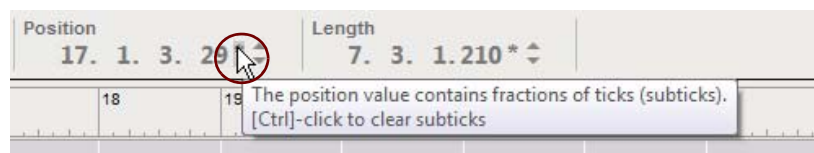

→ **To adjust the clip or event position (or length) to the closest tick value, press [Ctrl](Win) or [Cmd](Mac) and click on the asterisk in the display.**

The position or length value will now adjust to the closest tick value and the asterisk disappears.

! **When it comes to audio editing, you will have access all the way down to the sub-tick level. This means there won't be any sub-tick asterisks when editing audio.**

## About the “Match Values” function

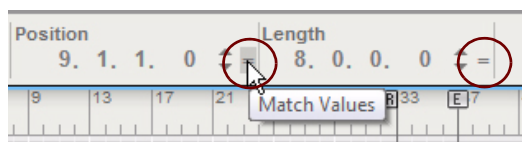

The “Match Values” function in the Inspector can be used to match the positions, lengths and/or values of several selected clips, notes, events or recordings to the position, length and/or value of the topmost (or leftmost) selected clip, note, event or recording. Refer to “Matching clips using the “Match Values” function”, “Matching audio values using the “Match Values” function” and “Matching notes or events using the “Match Values” function”.



# **Chapter 6**

## **Recording in the Sequencer**

# About this chapter

This chapter describes the different recording techniques that you can use in Reason. The chapter covers both audio, notes and parameter automation recording. Before you read this chapter, it's recommended that you are familiar with the basic sequencer functions and definitions described in the "Sequencer Functions" chapter. A lot of functions are common for all types of recording methods. These will be described first in this chapter. Later in the chapter we will go into functions specific to audio, notes and parameter automation recording.

## General recording functions

### Record enabling

Before you can start recording on a track in the sequencer, the track needs to be record enabled. There are two types of buttons for record enabling: the Record Enable button, which is used when recording audio clips and note clips, and the Record Enable Parameter Automation button, which is used when recording device/channel strip parameter automation and tempo automation:

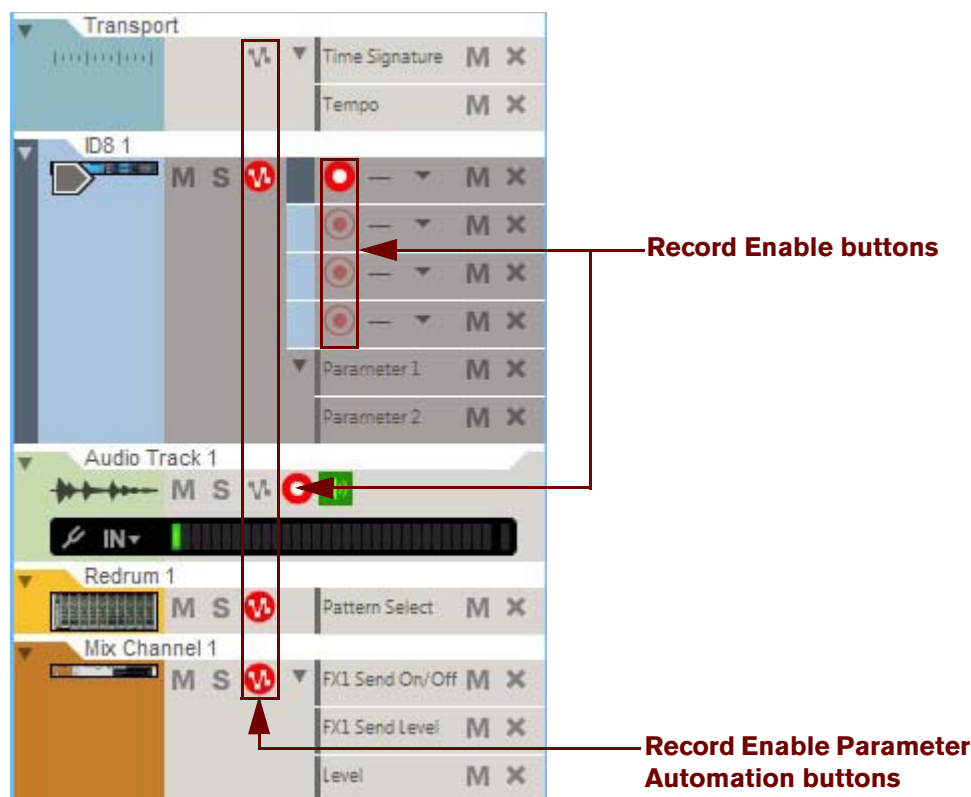

Five tracks with their Record Enable and Record Enable Parameter Automation buttons.

Activated Enable Record and Enable Record Parameter Automation buttons are indicated with a red color. Recording can be simultaneously enabled on an unlimited number of audio tracks (limited only by the computer's processing and hard disk performance) - plus one note lane on an instrument track. However, if you have locked several MIDI keyboard controllers to specific instrument devices in the rack - using Remote (see "Locking a surface") - you can record MIDI on these instrument tracks simultaneously. Recording of parameter automation can be simultaneously enabled on as many tracks as you like.

## Record enabling an audio track



Record Enable button (On)

- **To record enable an audio track, click on the Record Enable button on the audio track.**  
The Record Enable button goes red.

Selecting an audio track will automatically record enable the track if you have selected “Standard” mode in the “Master Keyboard Input” section on the “Keyboard and Control Surfaces” page in the Preferences dialog (see [“The Master Keyboard Input setting”](#)) - and if the Manual Rec button in the Track List is Off, see [“About the Manual Rec function”](#).

Also, depending on the setting in the “Monitoring” section on the “Audio” page in Preferences, monitoring of the input signal to the audio track may, or may not, be automatically activated - see [“Monitoring”](#).

## Record enabling multiple audio tracks

- **If you want to record audio from separate audio inputs on several tracks at once, click the Record Enable buttons on all desired audio tracks in the Track List.**

Each record enabled audio track will automatically unfold to show the Tuner button, the Select Audio Input drop-down list and the Input Meter. When recording audio on several tracks simultaneously, it doesn't matter which audio track has Master Keyboard Input.



Record Enable buttons (On)

*Multiple audio tracks record enabled, for recording audio on several tracks at once.*

## Record enabling an instrument track

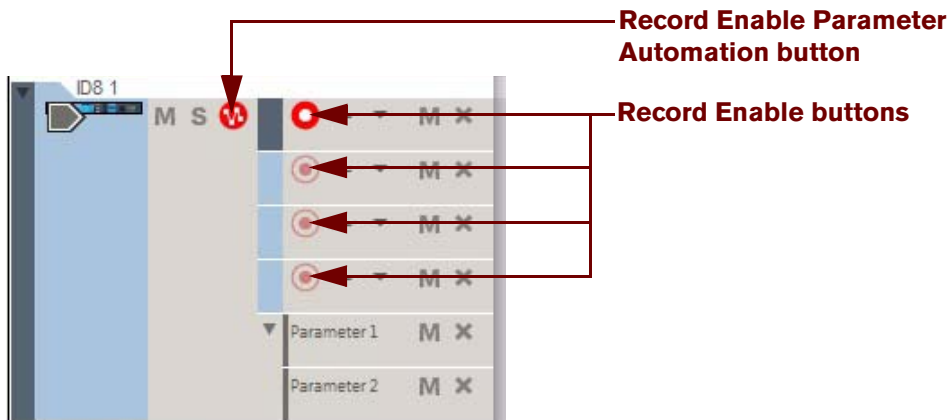

- **To record enable an instrument track, click on the Record Enable button on a note lane on the instrument track.**

The Record Enable button lights up red and the track has Master Keyboard Input.

If you have selected “Standard” mode in the “Master Keyboard Input” section on the “Keyboard and Control Surfaces” page in the Preferences dialog (see [“The Master Keyboard Input setting”](#)), selecting an instrument track will automatically set Master Keyboard Input to that track - if the Manual Rec button in the Track List is Off, see [“About the Manual Rec function”](#). An instrument track that has Master Keyboard Input will automatically be record enabled, and will also be enabled for parameter automation recording, indicated by the red Record Enable Parameter Automation button.

- **If you want to record on another note lane on the instrument track, just click the corresponding Record Enable button on the note lane.**
- ! **Only one note lane on one instrument track can have Record Enable active at a time, unless you have locked additional MIDI keyboard controllers to specific instrument devices in the rack (see [“Locking a surface”](#) in the Remote chapter). If you only have one MIDI keyboard controller (assigned as Master Keyboard), you can only record notes on one note lane at a time (see [“Setting Master Keyboard Input”](#)).**

## Record enabling several instrument tracks

If you have locked additional MIDI keyboard controllers to specific instrument devices in the rack (see “[Locking a surface](#)” in the Remote chapter), the corresponding tracks for all these locked devices are automatically record enabled - if the Manual Rec button in the Track List is Off, see “[About the Manual Rec function](#)”. These additional record enabled tracks are all displayed with the gray “Master Keyboard Input” symbol to the left of the device icon in the track list, and their Record Enable buttons are also automatically switched on. The track with “normal” Master Keyboard Input is also indicated with the gray Master Keyboard Input symbol to the left of its device icon.

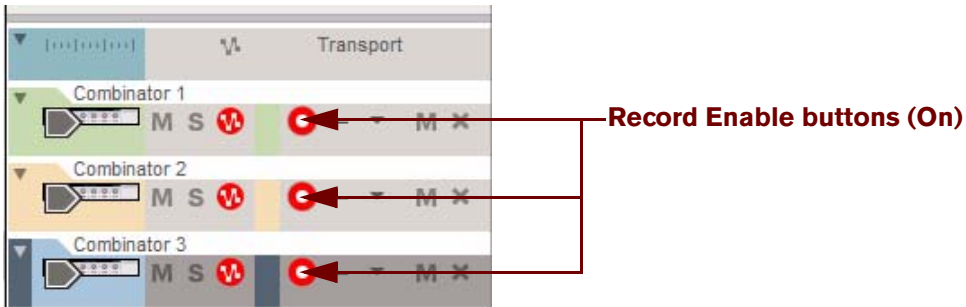

The “Combinator 3” track with Master Keyboard Input and the “Combinator 1” and “Combinator 2” tracks controlled from additional MIDI keyboards locked to the corresponding devices in the rack.

- **To manually enable/disable any additional record enabled instrument tracks that are locked to specific MIDI keyboard controllers, click the Record Enable buttons on a note lane on any of these tracks.**

## About the Manual Rec function

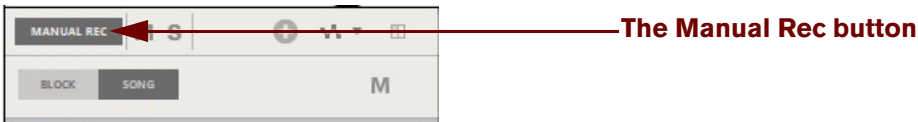

The Manual Rec button in the Track List.

The Manual Rec function in the Track List can be used if you don't want automatic record enabling of a selected track. For example, when you are finished recording your audio tracks and want to proceed with recording channel strip parameter automation, you probably don't want the audio tracks to be record enabled for audio.

- **Click the manual Rec button to disable automatic record enabling of selected tracks.**

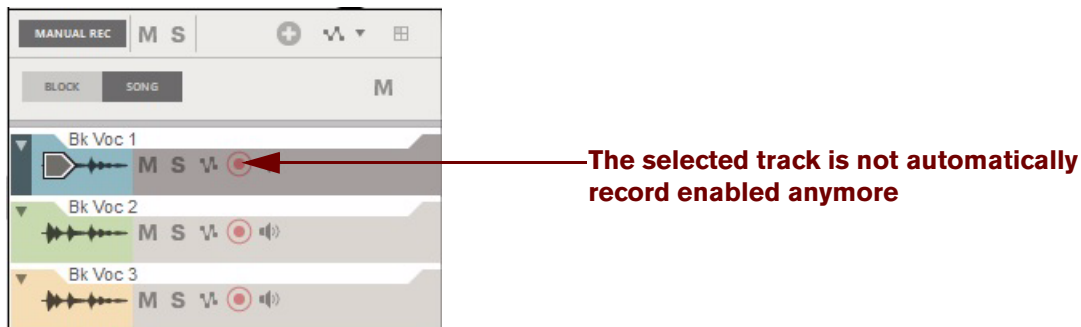

The Manual Rec function activated.

If you change your mind and want to record audio on an audio track, you have to manually record enable it by clicking its Record Enable button as described in “[Record enabling an audio track](#)”. Alternatively, switch off the Manual Rec button to enable the automatic record enabling again.

- ! **The Manual Rec function affects both audio tracks and instrument tracks.**

## Record enabling parameter automation

Parameter automation can be recorded on all track types, on one track at a time or on multiple tracks simultaneously.



- **Click on the Record Enable Parameter Automation button(s) on the desired track(s) in the Track List to enable parameter automation recording.**  
All tracks enabled for parameter automation recording will be indicated by red Record Enable Parameter Automation buttons.
- **Setting Master Keyboard Input to a track will automatically enable parameter automation recording, as indicated by the red Record Enable Parameter Automation button.**

## Record enabling pattern automation

Pattern automation can be recorded on tracks associated with pattern based devices such as the Redrum Drum Module, Dr. Octo Rex Loop Player or Matrix Analog Pattern Sequencer. Enabling pattern automation works in the same way as enabling regular parameter automation (see [“Record enabling parameter automation”](#)).

- ! **Note that enabling the Record Enable Parameter button on a track featuring a pattern based device will also allow automation recording of other device parameters besides the Bank and Pattern select buttons. Any additional device parameters will be recorded on separate parameter automation lanes just like with non-pattern devices.**

## Click and Pre-count

During recording and playback it's possible to have a metronome-style click sound to indicate the tempo of the song. In recording mode it's also possible to have the metronome click sound appear a selectable number of bars before the start of the actual recording, a so called pre-count. Activation of click and pre-count are managed on the Transport Panel:



*The Click and Pre-count controls on the Transport Panel.*

### Click

- **Click the Click button to get an audible metronome click as the sequencer plays. Alternatively, press [C].**  
The click will sound on every beat, with the first beat in every bar accented (higher pitched).

### Pre-count

- **Click the Pre button to get a pre-count (count-in) click sound before the recording starts. Alternatively, press [Ctrl](Win)/[Cmd](Mac)+[P]**  
Pre-count will only be present before you record - not when you start regular playback.



- **Select the number of pre-count bars by choosing “Number of Precount Bars” in the Options menu.**  
You can choose between 1 to 4 bars.

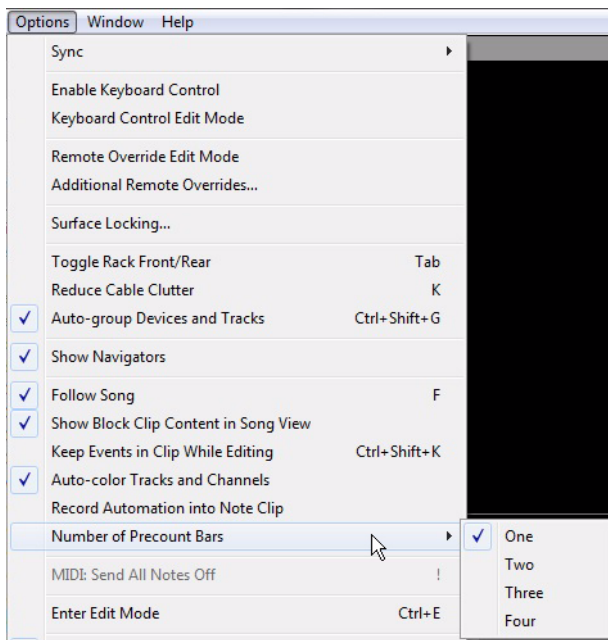

*Selecting number of pre-count bars.*

- **Feel free to experiment with different pre-count settings. For up-tempo (faster) songs it’s generally more convenient to have a little longer pre-count (3 or 4 bars) whereas for slower songs it’s often sufficient with 1-2 bars.**

## Click Level

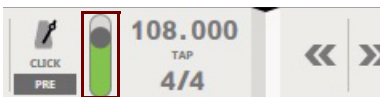

*Click Level slider.*

- **Adjust the audio level of the metronome click (and pre-count click) with the slider.**
- ! **Note that since the click sound is also routed via the selected audio card/interface on your computer - but not through the Reason mixer, the click sound will be summed to the rest of the sounds playing in your song. A high Click Level setting could therefore cause the Audio Output Meter on the Transport Panel, and the “Big Meter” in the Reason Hardware Interface, to indicate clipping. If this should occur, either lower the Click Level or deactivate Click to determine if it’s the click sound or the recorded sounds that cause clipping.**

## Loop mode

In loop mode, the song is automatically looped between the Left and Right Loop Locators on the Edit/Arrangement Pane during playback and/or recording:

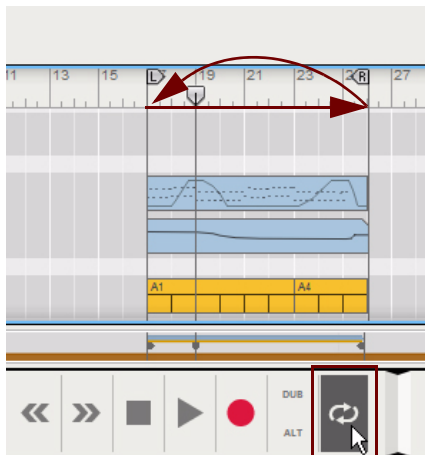

*Loop mode activated by clicking the Loop button on the Transport Panel.*

The behavior when recording in loop mode differs depending on what you're recording - audio, MIDI or parameter automation. Refer to ["Recording audio in Loop mode"](#), ["Recording notes in Loop mode"](#) and ["Recording parameter automation in Loop mode"](#).

## General recording procedure

The following description applies to all types of recording: audio, MIDI and parameter automation. For specific details of audio, MIDI and parameter automation recording, refer to “Recording audio”, “Recording notes”, “Recording performance controller automation” and “Recording parameter automation”.

1. If desired, select Click and/or Pre-count according to the descriptions in “Click and Pre-count”.
2. Move the Song Position Pointer to the position in the Ruler where you want to start your recording (see “Ruler details”).
3. Click the Record button on the Transport Panel. Alternatively, press [\*] on the numeric keypad, or hold down [Ctrl](Win) or [Cmd](Mac) and press [Return].

The Record button turns red. If Pre-count is enabled, wait for the set number of pre-count bars before starting to record audio, MIDI or parameter automation. During pre-count, nothing will be recorded.



*During pre-count, only the Record button is active (red) and nothing will be recorded.*

4. Start recording on the track.

As the recording begins, the Play button on the Transport Panel goes dark while the Record button remains red.



*During recording, both the Play and Record buttons are active and any input data will be recorded.*

If the lane is currently empty, a new clip is automatically created on the record enabled lane on the track. As the recording progresses, the clip expands following the Song Position Pointer. The clips are shaded in red during recording according to the picture below:

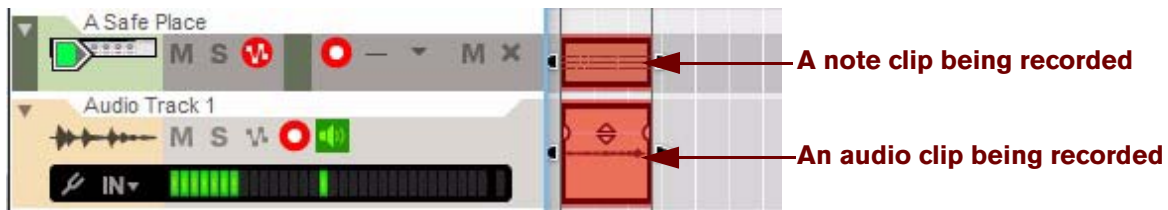

5. When you're done recording, click the Stop button on the Transport Panel. Alternatively, press [Spacebar], [0] on the numeric keypad, or hold down [Shift] and press [Return].

The Record and Play buttons turn gray, the Song Position Pointer stops and the red shading of the clip(s) disappears. The clip(s) show the recorded events as different types of graphical objects, depending on clip type.

- ! If nothing was recorded in a note clip, clicking Stop will automatically remove the empty note clip.

## Undoing a recording

- If you're not satisfied with the finished recording, you can select "Undo Record Track" from the Edit menu or select the clip on the Edit/Arrangement Pane and press [Delete] or [Backspace]. This will delete the clip and its contents.

## Undoing while recording a note clip

- If you're not satisfied with your ongoing recording of a note clip, press [Delete] or [Backspace]. This will delete the current note clip and all its contents and at the same time create a new clip starting at the current song position. The sequencer will continue recording during the entire process.
- ! Note that this only works when recording note clips.

## Recording tips

### Lowering the Tempo during recording

If you are going to record complex/difficult takes, a good suggestion is to lower the song tempo during recording and then speed up the song to normal tempo again during playback. For audio tracks, Reason features very sophisticated functions for audio stretching. Audio stretch enables you to alter the song tempo up or down without changing the pitch of the recorded audio. See "[About tempo changes and tempo automation of audio tracks](#)" for more details.

When recording MIDI, just lower the tempo when recording the difficult parts and speed up to normal tempo during playback.

## Audio recording details

### Setting up the audio track

#### Selecting audio input(s) and defining mono or stereo

- Select audio input(s) for the track from the Audio Input drop-down list.



Selecting audio inputs for the Audio Track.

At the top of the drop-down list you can select whether you want to use mono or stereo inputs. Depending on your selection, the LED meter switches to a stereo or mono display. Further down in the drop-down list you can select the audio interface input(s) you want to use for the track.

- If you are using the Propellerhead Balance audio interface, selecting any of its input channels in the drop-down list will automatically switch on the corresponding Ready LEDs on the Balance front panel. Also, if you have selected "Mono Input" in the Audio Input drop-down list, the Audio Track will show a CS (Clip Safe) symbol to the right of the LED meter.

## Setting input level(s)

Before you start recording audio on the track it's very important to set correct input level(s). The input signal should be loud enough to minimize noise and provide high quality, but not so loud that it causes clipping and distortion.

If you're using a 24-bit audio interface (recommended), aim at having the level of the input signal around -12dB on the track Input Meter according to the picture below. For 16-bit audio interfaces you may want to raise the level another couple of dB's.

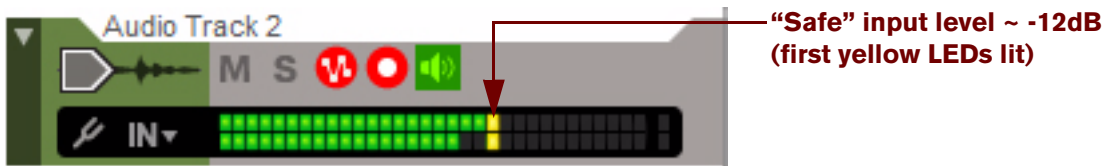

- To get a better view of the input levels, use the separate Recording Meter Window, see [“The Recording Meter Window”](#).
- ! If you are using the Propellerhead Balance audio interface you can use the special Clip Safe function to protect your recordings from accidental audio input clipping, see [“Recording using the Clip Safe function in Propellerhead Balance”](#).
- ! Always adjust the input level at the source (e.g. the preamp connected to, or built-in to the audio interface).
- ! If the input signal level should exceed 0dB (red clipping LEDs to the right) on the track Input Meter at any time during recording, there could be audible distortion in the recording:

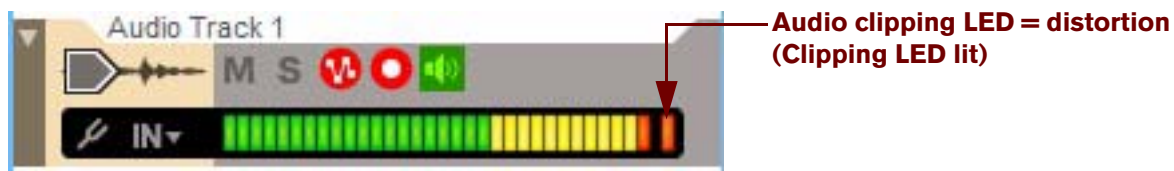

If the input level should clip, at any time, the red clipping LED(s) in the Input Meter will be constantly lit until you click on the Input Meter. This is to notify that there is, or has been, too loud an input signal present on the track.

- ! The input level cannot be adjusted using the Channel strip controls in the Main Mixer. The Channel strip controls are used only for adjusting the level and characteristics of the monitored signal and/or the playback signal of an existing recording on the track.

## Using the Clip Safe function with Propellerhead Balance

- ! Note that the Clip Safe function only works together with the Propellerhead Balance audio interface.

If you use the Propellerhead Balance audio interface together with Reason, you will have access to the Clip Safe function. The Clip Safe function lets you record a mono signal with an additional “invisible” headroom. This is done by using both AD converters in Propellerhead Balance for the same mono signal, with the second AD converter dedicated to the additional headroom.

When recording with the Clip Safe function, Reason records the mono signal in parallel using both AD converters. The original AD converter records the signal at normal level and the second AD converter records the same signal “padded” at a lower level.

In practice this means that if the input signal should exceed the normal 0dB clipping level during recording, the program will allow you to use the “padded” signal from the second AD converter and replace the clipped/distorted audio. The padded signal will be amplified in Reason so that its level accurately reflects the original recording level. In other words, the resulting signal will be just as loud as the original signal - but without any clipping or distortion.

Proceed as follows to activate the Clip Safe function:

1. Select “Mono Input” in the Audio Input drop-down list on the Audio Track and then select either “Balance 1/L” or “Balance 2/R”.



The CS (Clip Safe) symbol appears to the right of the level meter on the Audio Track.

2. Press the Clip Safe button on the Propellerhead Balance front panel.

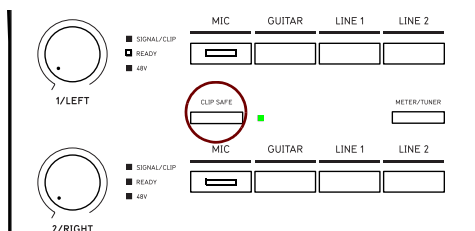

The Clip Safe button on the Propellerhead Balance audio interface.

A Clip Safe request signal is sent from the Balance interface to Reason. Depending on what audio inputs are selected on the record enabled Audio Track(s), the following happens:

- **If the Balance 1/L or 2/R input is selected as audio input (Mono) on one single record enabled Audio Track, the Clip Safe LED on the Balance interface turns green and the CS symbol on the Audio Track is lit.**  
When the Clip Safe LED on the Propellerhead Balance audio interface is green, the Clip Safe function is enabled. If the 1/L input is selected as audio input (Mono), the Right channel on the Balance interface is used for the additional headroom, and vice versa.
- **If the Balance 1/L and 2/R inputs are selected as Stereo Input, the Clip Safe function is disabled and the Clip Safe LED on the Balance interface turns red. The CS symbol on the Audio Track also disappears.**  
The Clip Safe function requires both inputs to be available. Also, if the Balance 1/L (mono) and 2/R (mono) inputs are selected as audio inputs on other record enabled Audio Tracks, the Clip Safe function is disabled.

See “Recording using the Clip Safe function in Propellerhead Balance” for more information about using the Clip Safe function.

## Monitoring

Monitoring means listening to the input signal of an audio track. Monitoring works according to the following principles:

- **By default, monitoring is automatically enabled as soon as an audio track is record enabled.**  
This makes it possible to hear what you will be recording - before and during recording to disk.
- **During playback of an audio track, monitoring is automatically disabled.**  
During playback, you will only hear the recorded signal - not any input signal.
- **Note that you can manually activate or deactivate monitoring for a track by clicking the Monitor button.**

The input signal is monitored after the Channel strip and Master Section in the Main Mixer which means that all mixer parameters, including any Insert Effects, Dynamics etc., will also be applied to the monitored signal.

- ! **Note that the Main Mixer parameters will only affect the monitored (and/or played back) signal - they will not affect the signal being recorded to disk.**

Depending on the technical specifications and/or settings in your hardware audio interface, the latency of the monitored input could become a problem. If this is the case, it's probably better to monitor the input signal before it reaches the Reason program, i.e. directly on the external audio interface/mixer/preamp. If you don't want to monitor through the Reason program you should select "External" or "Manual" in the Monitoring section on the Audio tab in the Preferences dialog:

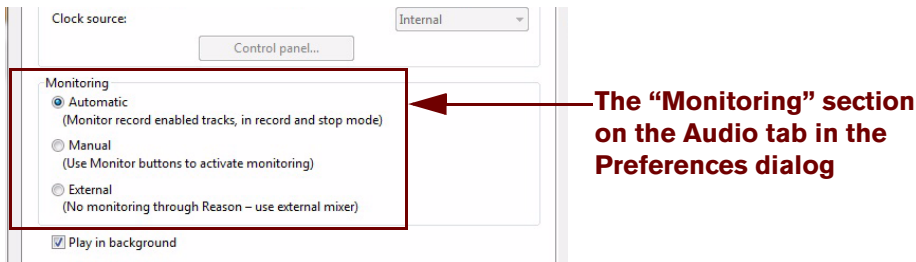

- **Select "Automatic" to select automatic monitoring of the Audio Track in Reason.**  
Each time you select and/or record enable an Audio Track in the Track List, monitoring in Reason will be automatically enabled. It's possible to manually disable monitoring in this mode if you like.
- **Select "Manual" to manually select if monitoring should be on or off.**  
This mode should be selected if you prefer to have manual control over monitoring, or when you are monitoring through external mixer or audio interface. In the latter case, you would select "Manual" mode and just don't click any monitor buttons.
- **Select "External" to deselect automatic monitoring of the Audio Track in Reason.**  
When you select and/or record enable an Audio Track in the Track List, monitoring in Reason will be automatically disabled. It's not possible to manually enable monitoring in this mode.

## Using the Tuner

An audio track also features a built-in tuner function. The Tuner detects and displays the input pitch of a connected instrument - an electric guitar, for example.

1. **Click the "Enable Tuner" button below the device icon to switch to Tuner mode.**  
The Input Meter switches to a Tuner.



*An audio track in Tuner mode.*

2. **Play a note on the connected instrument and watch the Tuner.**  
When the input pitch is detected, the Tuner lights up and indicates how far the pitch is from the displayed note value to the right of the Tuner. The center LED on the Tuner Meter indicates a perfectly tuned note pitch. The green arrow LEDs on either side of the Tuner Meter indicate how the connected instrument should be tuned. The left arrow LED means raise the pitch and the right means lower the pitch.
- ! **Note that the input note needs to sustain for a little while before the pitch can be detected.**

## The Recording Meter Window

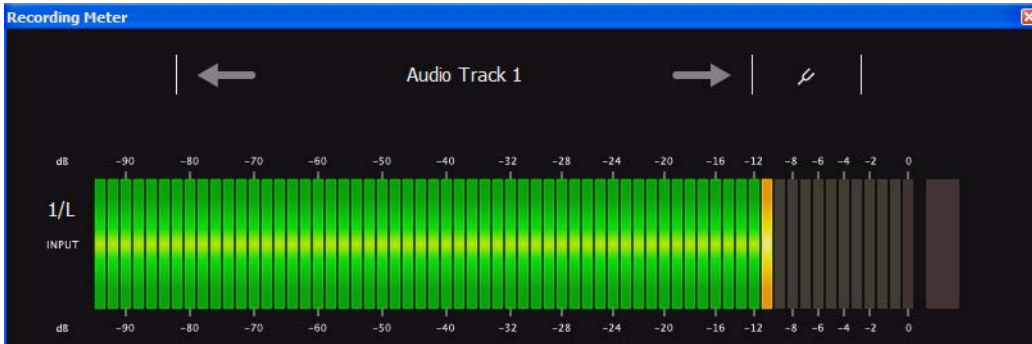

The main purpose of the Recording Meter floating window is to provide a good overview of recording levels and/or tuner values when you are located some distance away from the computer screen. The Recording Meter mirrors the information from the input level meter and Tuner of the currently selected record enabled Audio Track.

- **Toggle the Recording Meter window on and off by selecting “Show/Hide Recording Meter” from the Windows menu.**
- **If you are using the Propellerhead Balance audio interface you can also press the Meter/Tuner button on the front panel to toggle the Recording Meter window on and off:**

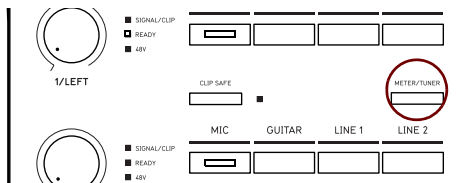

*The Meter/Tuner button on the Propellerhead Balance audio interface.*

- **Move the Recording Meter window by clicking on the window background and then dragging.**
- **If you have manually record enabled several Audio Tracks in the sequencer, you can choose which track to display in the Recording Meter window by clicking the right/left arrows on either side of the Audio Track name.** By default, the first record enabled Audio Track in the sequencer is displayed in the Recording Meter window.
- **Click the pitchfork symbol in the Recording Meter window to bring up the Tuner for the selected Audio Track.** A large Tuner display is shown at the bottom of the Recording Meter window.

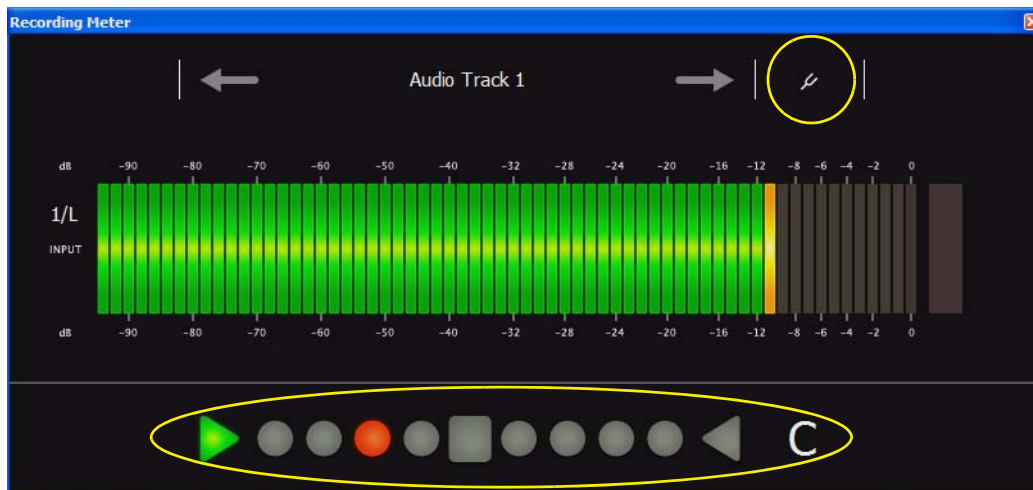

See “Using the Tuner” for more information about the Tuner.



## Recording audio

! To minimize the song saving time, we strongly recommend saving the song before recording many or large audio recordings.

1. Set up the audio track according to the descriptions in **“Setting up the audio track”**.
2. Record the track according to the descriptions in **“General recording procedure”**.
3. When the recording is finished, the audio clip on the track shows the recorded audio as one or two continuous waves inside the clip, depending on whether the input was in mono or stereo:



*An audio clip with a stereo audio recording.*

## Recording using the Clip Safe function in Propellerhead Balance

If you are recording using the Propellerhead Balance audio interface, you can utilize the Clip Safe function to protect your recordings from any accidental input signal clipping. The program can then take care of and heal any input signals that accidentally exceed 0dB.

See **“Using the Clip Safe function with Propellerhead Balance”** for more details.

! **Note that the Clip Safe function can only be used when recording in mono (single audio input) and only on one record enabled Audio Track at a time.**

Proceed as follows to set up and activate the Clip Safe function:

1. **Select the desired Audio Track for recording.**

2. **Select audio input in the drop-down list.**

! **Note that you can only select the Balance In L or R (Mono Input) for the Clip Safe function to be available.**

3. **Press the Clip Safe button on the Balance front panel.**

The Clip Safe LED on the Propellerhead Balance audio interface turns green. The CS indicator to the right of the input level meter on the Audio track is lit:



*The Clip Safe LED on the Propellerhead Balance interface and the CS indicator on the Audio Track.*

4. **Record the track according to the descriptions in **“General recording procedure”**.**

- ! **We recommend that you aim at -12dB maximum recording level, even if you are using the Clip Safe function. Recording high input levels will result in very loud audio on the track, which could be problematic to mix with the rest of the instrument tracks in your song.**

When the Clip Safe function is active, the Input Meter on the Audio Track, as well as the level meter in the Recording Meter window get their red LEDs replaced by yellow ones. The Recording Window also gets a Clip Safe symbol to the upper right:

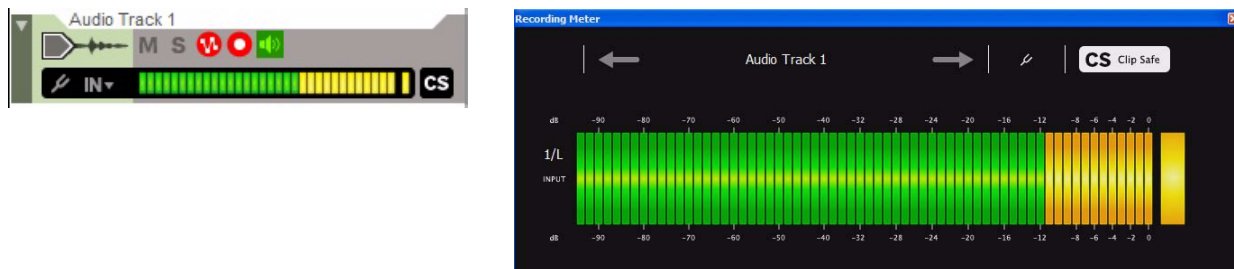

*The Input Meter on the Audio track and the Recording Meter gets yellow LEDs instead of red ones.*

5. **When the recording is finished, the audio clip on the track shows the recorded audio as a continuous wave inside the clip.**

The red vertical line(s) at the top of the of the audio clip indicate that Clip Safe was activated since the input level exceeded 0dB. The selected audio clip also gets an additional Heal (CS) button on its upper right hand side:



*Audio recorded with the Clip Safe function active.*

6. **Play back the track and hear where the signal clips.**

You should hear this when the playhead passes over the red vertical line(s) in the audio clip. Sometimes, though, if the clipping is moderate it might not be audible.

7. **To permanently heal the audio clip and use the Clip Safe audio, click the Heal (CS) button to the upper right-hand side of the audio clip. Alternatively, select “Heal Clip Safe Clips” from the Edit menu or audio clip context menu.**

Now, the clipped/distorted audio has been replaced by the “padded” Clip Safe audio and the recording should not clip or distort anymore. The area above the audio clip disappears, as does the Heal (CS) button.

- If you like, you can zoom out using the Waveform Zoom Level buttons to view the resulting waveform in its entirety in the Audio Clip (see **“Waveform Zoom Mode”**).
- The healing operation can also be performed on several selected audio clips in one go. Just select the desired clips and click a Heal (CS) button on one of the clips.
- If you want to remove the Clip Safe parts and keep the clipped/distorted parts, just undo the healing operation using the standard [Cmd](Mac)/[Ctrl](Win)+[Z] command.
- If you want to permanently delete the Clip Safe audio and keep the clipped/distorted audio, select **“Delete Clip Safe Audio”** from the Edit menu or audio clip context menu.
- In Edit Mode, the audio clip will have the same graphical appearance (the clipped/distorted parts indicated by red vertical lines, plus the Heal (CS) button to the right in the Clip Overview).

## Recording audio in Loop mode

Recording audio in Loop mode is very useful if you want to record alternative takes of the same part of the song. For example, let's say you want to sing a couple of takes of the chorus part of your song to later create the perfect chorus by selecting the best parts of the different takes.

! **To minimize the song saving time, we strongly recommend saving the song before recording many or large audio recordings.**

Proceed as follows to record audio in Loop mode:

1. **Set up the audio track according to the descriptions in “Setting up the audio track”.**
2. **Set the Left and Right Locators to span the chorus part of your song.**
3. **Enable the Loop function by pressing [L] or by clicking the Loop On/Off button on the Transport Panel:**



*Loop mode activated on the Transport Panel.*

4. **Click the L button on the Transport Panel to move the Song Position Pointer to the Left Locator.**



5. **Record the track according to the descriptions in “General recording procedure”.**

6. **Start singing to record audio on the track.**

When the Song Position Pointer has reached the Right Locator, the recording starts over from the Left locator again and you can now record a second take. The audio recorded in the previous take won't be heard but is saved in the “background” on a Comp Row.

Continue recording for as many loop cycles as you like.

7. **When the recording is finished, the audio clip on the track shows the last recorded audio take as one or two continuous waves inside the clip (depending on whether the input was in mono or stereo).**

! **If you recorded the last loop cycle throughout the entire clip length, the audio clip will be a Single Take clip. If you stopped recording the last loop cycle somewhere in the middle of the clip, the clip will be a Comp Clip.**

8. **Double-click the clip to open it for editing.**

- **If the last loop cycle was recorded throughout the entire clip length, the clip opens for editing inline.** If so, open the clip in the Comp Editor by clicking the “Open in Comp Edit” button in the Track List.

Otherwise, it opens in the Comp Editor right away. In the Comp Editor, you can see that there is one Comp Row for each of the recorded loop cycles (Takes):

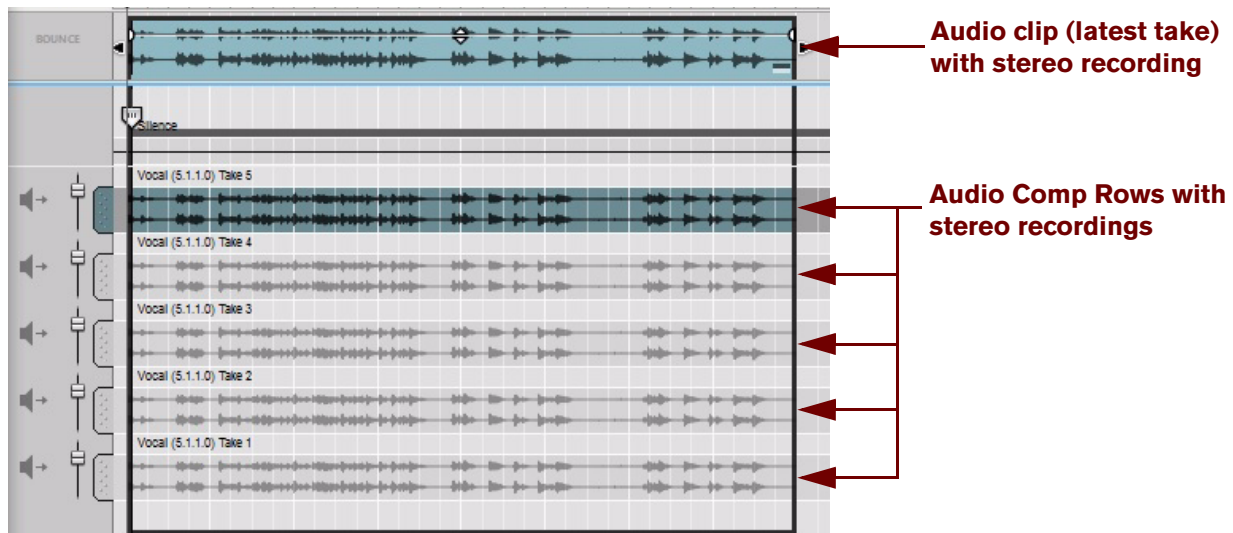

*Audio recorded in Loop mode with 5 loop cycles (Takes) recorded.*

From here, it's easy to assign the best parts from the different takes and comp them into a final clip. See [“Creating a comped audio clip”](#) for details.

- ! **If you have recorded using the Clip Safe function with the Propellerhead Balance audio interface, any clipped parts are displayed with vertical red lines above each Comp Row. If you decide to heal the audio clip using the Heal (CS) button or “Heal Clip Safe Clips” from the Edit menu or context menu of the selected audio clip, the recordings on all Comp Rows are healed in one go.**

## Overdubbing audio using the “Dub” function

Back in the tape recorder days, overdubbing was used to record additional takes on additional tracks on the same section of the tape, to create a complete arrangement. For example, recording a vocal chorus part could be done by overdubbing the singer three or four times on additional tracks. Overdubbing in Reason works in a similar way, but with much better control, and much better editing possibilities afterwards.

- **After you have recorded the first take on an audio track, click the “Dub” button on the Transport Panel.** This will create a new audio track with a duplicate of the original audio track settings, including the channel strip settings (with insert effects etc.). Now, you can continue recording on the new audio track as described in [“Recording audio”](#) and [“Recording audio in Loop mode”](#). Afterwards, you can edit the new track completely independently of the original track.
- **The “Dub” function can also be used on-the-fly while recording.**

## Duplicating audio tracks using the “Alt” function

Closely related to the “Dub” function, described in [“Overdubbing audio using the “Dub” function”](#), is the “Alt” function. This function can be used to create a new audio track with an identical copy of the selected audio track's settings. The only difference between the “Alt” and “Dub” functions is that the Alt function will automatically mute the original audio track.

→ **Select the audio track you want to duplicate and then click the “New Alt” button on the Transport Panel.**

This will create a new audio track with a duplicate of the original audio track settings, including the channel strip settings (with insert etc.). Now, you can continue recording on the new audio track as described in “Recording audio” and “Recording audio in Loop mode”. Afterwards, you can edit the new track completely independently of the original track.

– The “Alt” function can also be used on-the-fly while recording.

## Recording over or into an existing audio clip

If you start recording over an existing clip on an audio track, the new recording will incorporate (replace, but not erase) the previous recording in the clip. When you open the audio clip in the Comp Editor afterwards, there will be one Comp Row for each of the takes, the same result as when recording audio in Loop mode (see “Recording audio in Loop mode”).

Let’s have a look at the following example:

In the picture below, we have the original audio clip spanning bars 1-8 on the track:



*An audio track with an existing clip.*

Now, we want to redo (re-record) the part that spans bars 5-6. We place the Song Position Pointer at bar 5 and record 2 bars:

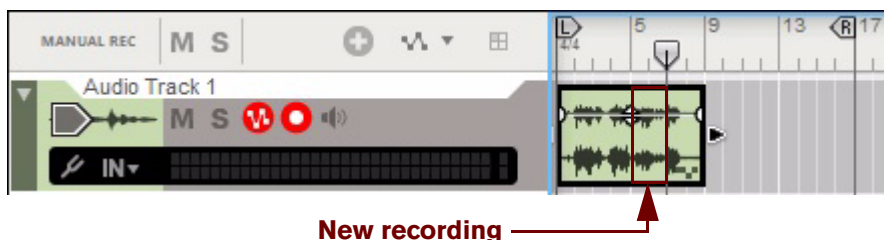

*A new recording made on bars 5-6 on the audio track.*

The new recording is made over the original clip. The recording in the original clip has therefore been incorporated into the start of bar 5 to the end of bar 6.

You can also see that the clip has become a Comp Clip, as indicated by the symbol (gray dots) at the lower right corner of the clip.

Now, let's double-click the clip to open it in the Comp Editor:

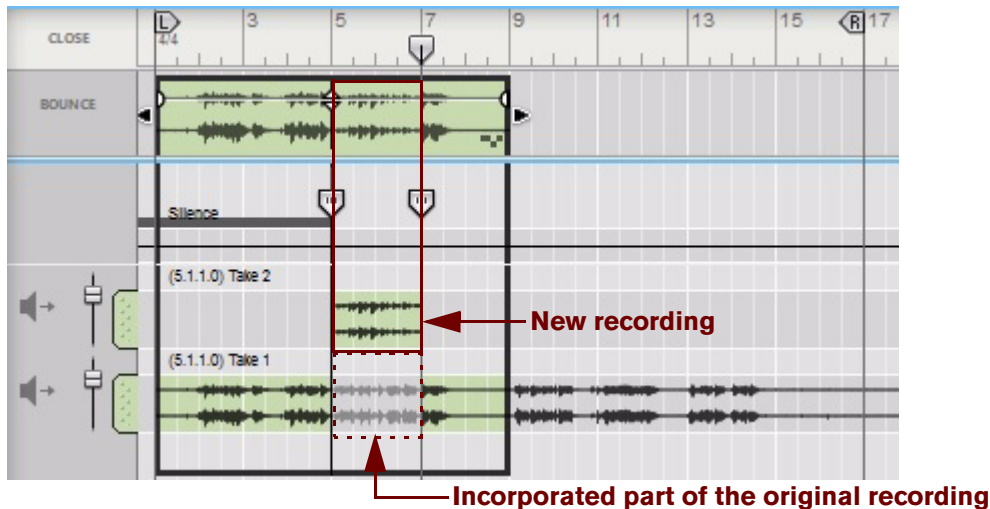

*The new and original recordings (takes) in Edit Mode.*

The new recording has incorporated bars 5-6 of the original recording. However, the original recording in bars 5-6 has been left totally unaffected. The entire original audio recording now resides on the "Take 1" Comp Row and the latest recording resides on the "Take 2" Comp Row. The resulting clip will now play back the "Take 1" recording in bars 1-4 and 7-8. Bars 5-6 will play back the "Take 2" recording.

See ["Creating a comped audio clip"](#) for details on how to extract parts from individual takes and comp into a final clip.

## Recording audio from Mix Channel outputs

Besides recording external audio from the inputs of your audio interface, it's also possible to record audio internally from the outputs of Mix Channel or Audio Track devices. Typical applications for this could be:

- **Recording the audio from an Output Bus (sub mixer) Mix Channel.**  
You might have the individual drums of your drum kit on separate tracks and these tracks are routed to a Mix Channel which is set to work as an Output Bus (see ["Output Busses"](#)). You then want to record the audio from the Output Bus onto a new Audio Track.  
  
In this situation, all you need to do is create a new Audio Track, activate the Rec Source button on the Output Bus Mix Channel device, and then select the Output Bus in the Select Audio Input drop-down list on the Audio Track in the Track List. Then, record the audio from the Output Bus as described in ["Recording audio"](#).
- **Re-recording of an audio track with effects applied.**
- **Recording when playing back an instrument or audio track while making live manipulations of effects or parameters.**
  - If you want to record the audio from an Instrument track onto an audio track, without making any live manipulations, you can also use the ["Bounce Mixer Channels"](#) function - see ["Bouncing Mixer Channels"](#).

The example below describes how to capture and record the audio from an ID8 device, but the general method can be used for other recording scenarios as well:

1. **Create an instrument track for the instrument device you want to record according to the descriptions in ["Creating an instrument track"](#).**  
You won't actually be recording on the instrument track in this situation. However, you will need the instrument track to be able to play the instrument device from your connected master keyboard.
2. **Create an audio track according to the description in ["Creating an audio track"](#).**

**3. In the rack, locate the Mix Channel device connected to the ID8 instrument device and click its “Rec Source” button.**

The “Rec Source” button on Mix Channel devices is used for real-time audio recording of devices connected to the Mix Channel device.

The “Rec Source” button on Audio Track devices are used for real-time re-recording of audio tracks.



*Enabling the Rec Source button on the Mix Channel device in the rack.*

**4. Locate the audio track and select “Stereo Input” and “ID8 1” as input source in the “Select Audio Input” drop-down list.**

All Mix Channel and Audio Track devices that have their “Rec Source” button enabled will appear in the list. In this example, we only have the Rec Source button active on the “ID8 1” Mix Channel.

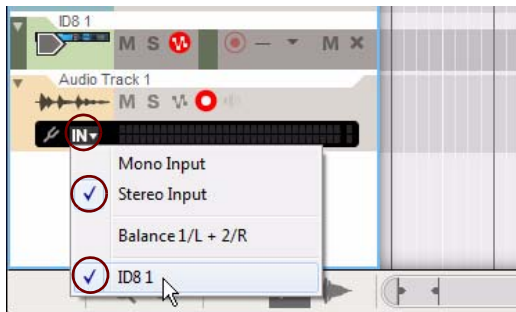

*“Stereo Input” and “ID8 1” selected in the “Select Audio Input” drop-down list.*

**5. Select the instrument track, in this example the ID8 1, so that it has Master Keyboard Input (red frame around the device icon) and disable the “Record Enable” button.**

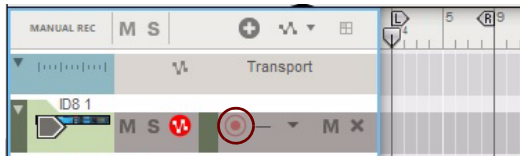

*Select the ID8 1 track and disable the Record Enable button.*

**6. Locate the audio track and record enable it by clicking the Record Enable button.**

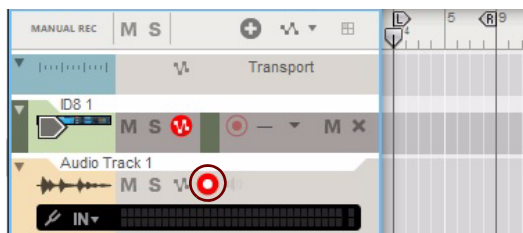

*Engage Record Enable on the Disk Channel track.*

**! Don't set Master Keyboard Input to the audio track - only click the “Record Enable” button on the audio track! This way, the ID8 1 instrument track will still have Master Keyboard Input.**

7. Play the master keyboard and set the input level to the audio track by adjusting the Level Fader on the ID8 1 Mix Channel strip in the mixer.

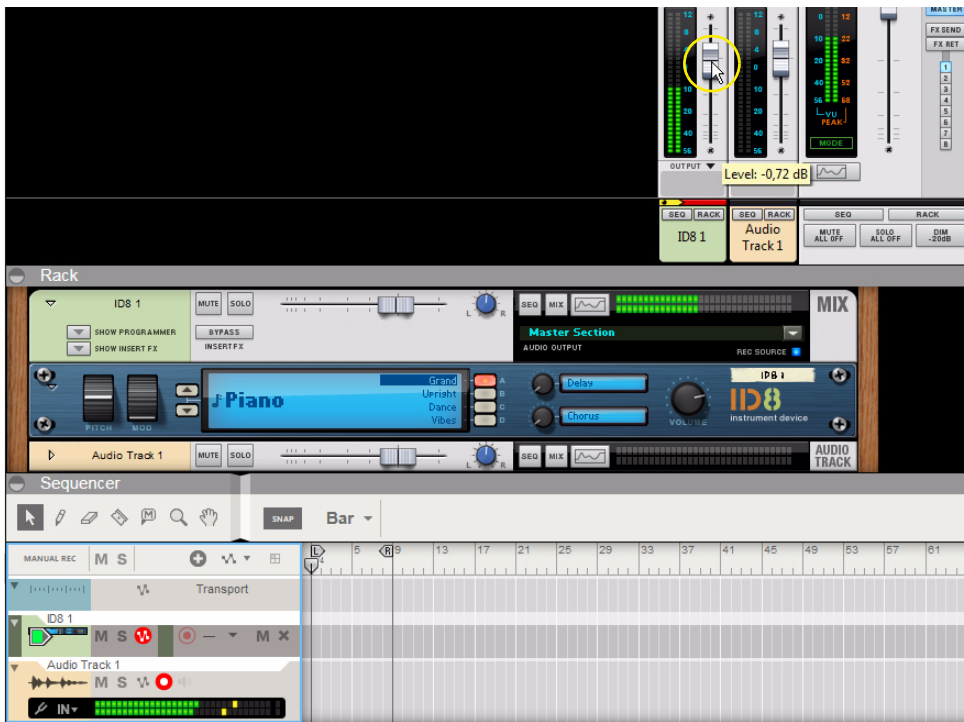

*Adjusting the instrument's level to the audio track.*

- ! **A Volume setting of -0.0 dB on the instrument device and a Level Fader setting of -0.0 dB on its corresponding Mix Channel strip in the mixer is often the optimal setting to avoid audio signal clipping. As when recording external audio, it's the track's Input Meter that should be observed for any clipping.**
8. Start recording audio on the audio track according to the description in **“Recording audio”**.
    - By using the recording method described above, it's also possible to record the audio from previously recorded note clips on instrument tracks.

## Recording a mixdown of several audio tracks

Another useful feature is to record a real-time mixdown of several previously recorded audio tracks onto a new, additional audio track. This is sometimes also referred to as recording stems or sub-mixes. Let's say we have four backing vocal tracks that we want to mix down and record on a new audio track. We can do this as follows:

1. **Create a new audio track according to the description in “Creating an audio track”**.  
This is the track we're going to use for recording the mixdown. We name the track “Mixdown” to make it easier to distinguish.
2. **Locate the Master Section device in the rack and click its “Rec Source” button.**



*The “Rec Source” button on the Master Section device.*

This will allow you to record the output from the Master Section onto the new audio track.



3. Locate the four backing vocal Audio Track devices in the rack, or their corresponding channel strips in the mixer, and click their “Solo” buttons.



*The four backing vocal Audio Track devices soloed.*

Since we’re going to record the four backing vocal tracks through the outputs of the Master Section, we only want the backing vocal tracks to sound. All other tracks in the song should therefore be muted.

4. Select the “Mixdown” track in the sequencer and select “Stereo” and “Master Section” from the “Select Audio Input” drop-down list.

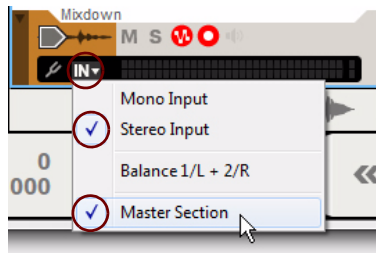

*“Stereo” and “Master Section” selected as Audio Input source.*

Selecting “Stereo” makes it possible to pan the backing vocal tracks in stereo before recording on the mixdown audio track.

5. Adjust the parameters of each of the backing vocal track channel strips as desired.

- Don’t forget to set the panning of each of the tracks to spread them in the stereo panorama.

- Select the “Mixdown” track in the sequencer and click the “Rec” button on the Transport Panel to start recording the mixdown.



*Recording the mixdown of the four backing vocal tracks to the “Mixdown” track.*

- During recording, you might want to perform real-time adjustments of the backing vocal tracks’ channel strip parameters to create a “live” mix.
- When you have recorded the mixdown, click “Stop” on the Transport Panel.

8. Before you play back the song with the mixdown track, remember to un-solo the four backing vocal Audio Track devices/channel strips. Also, mute the four original backing vocal tracks in the sequencer to avoid “double” sounds.



*Playing back the Mixdown track with the original backing vocal tracks muted in the sequencer.*

- Another alternative, if you want to record several Audio Tracks or Mix Channels onto a single audio track, is to create a sub-mixer setup - see “Output Busses”.

# Note recording details

Note events can be recorded for instrument devices and are contained in note clips. Performance controller events, such as Mod Wheel, Pitch Bend and Aftertouch events, can also be recorded for instrument devices, and be contained in note clips, but they are described separately in [“Parameter automation recording details”](#).

## Setting up the instrument track

To record notes for an instrument device - or for an external MIDI instrument - on a track in the sequencer, you need only create an instrument track as described in [“Creating an instrument track”](#). The instrument track will automatically have Master Keyboard Input and the note lane will automatically be record enabled. Since you will only be recording MIDI events on the instrument track - and no audio - there is no need to adjust audio levels etc. These can always be adjusted afterwards.

If you want to control an external MIDI instrument, simply create an External MIDI Instrument device and select the appropriate MIDI port and channel on the device panel. See [“External MIDI Instrument”](#) for more details.

### About “Quantize During Recording”



*The Q Record (Quantize During Recording) button on the Transport Panel.*

It's possible to quantize MIDI notes as they are being recorded. This will automatically align the start positions of the recorded notes to a pre-defined grid. Refer to [“Quantize”](#) for more details.

## Recording notes

1. **Set up the instrument track according to the description in [“Setting up the instrument track”](#).**
2. **Record the track according to the description in [“General recording procedure”](#).**
3. **When the recording is finished, the note clip on the lane shows the recorded note events in a piano-roll fashion inside the clip:**

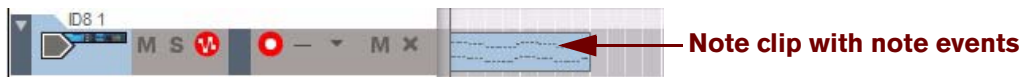

*A note clip with note events.*

The note clip's start and end boundaries will automatically snap to the closest bar to make it easier to arrange (move etc.) later on.

- ! **If no MIDI events (notes and/or performance controllers) were recorded, the empty note clip will be automatically removed from the lane after you have clicked Stop.**
- **It's also possible to manually insert notes by drawing them with the Pencil tool. Refer to [“Drawing notes”](#).**

## Recording notes in Loop mode

Recording on a note lane in Loop mode allows you to continuously add new notes in a defined section of your song:

1. **Set up the instrument track according to the description in [“Setting up the instrument track”](#).**
2. **Set the Left and Right Locators to span the desired part of your song.**

3. Enable the Loop function by pressing [L] or by clicking the Loop On/Off button on the Transport Panel:



Loop mode activated on the Transport Panel.

4. Click the L button on the Transport Panel to move the Song Position Pointer to the Left Locator.



5. Record the track according to the description in “General recording procedure”.

When the Song Position Pointer has reached the Right Locator, the recording starts over from the Left Locator again and you can record additional notes. Any new recorded notes will be added to the previously recorded ones and all notes will be heard during the recording.

Continue recording for as many loop cycles you like.

## Recording over or into an existing note clip

Recording over or into an existing note clip will simply add new note events to the previously recorded events in the note clip as described in “Recording notes in Loop mode”. However, If the new recording should start before the original clip, and expand into the original clip, a new clip will be created and will engulf the original clip. Let’s have a look at the following example:

In the picture below, we have the original note clip spanning bars 4-13 on the track:



A note lane with an existing clip.

Now, we’re going to record an intro which is going to span the first four bars:

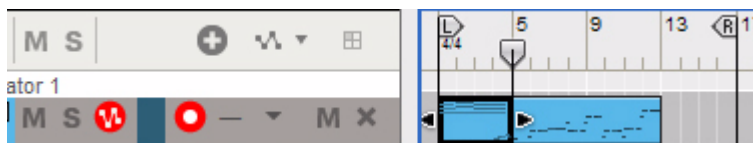

A new note clip recorded on bars 1-4 on the same note lane.

The new clip is partly recorded over the original clip. The part of the original clip that has been recorded over is incorporated in the new clip; the events from the original clip are now contained in the new clip, and the start of the original clip has been moved to bar 5, where the new clip ends.

! If you’re recording over or into a masked clip and the new clip engulfs masked events, the masked events will be permanently deleted! See more about masked events in “About masked recordings and events”.

- Another, perhaps more convenient, way of overdubbing on an instrument track is to create additional note lanes and record new clips on these using the New Dub or New Alt functions described in “Recording notes using the “Dub” and “Alt” functions”. This way, you will get a better overview of exactly what you added in each of your recordings.

## Recording notes using the “Dub” and “Alt” functions

A practical way of recording additional MIDI events on an instrument track is to use the “Dub” and “Alt” functions.



### The “Dub” function

The “Dub” function creates additional record enabled note lanes on which you can record “overdubs”. This is the function to use when you want to add new notes in the same section of the instrument track but want the notes to end up in new clips on additional note lanes instead of in the original clip. All note lanes will play back together.

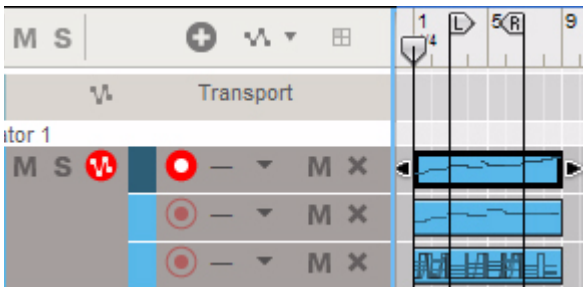

*The “Dub” function used for creating two additional lanes for overdub purposes. Loop mode is Off.*

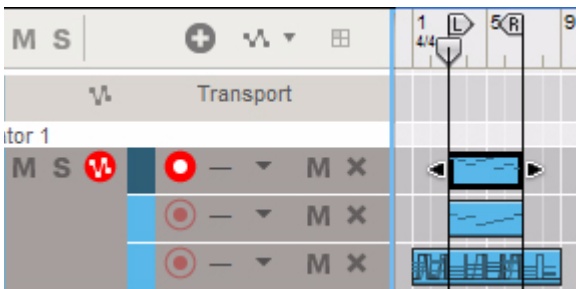

*The “Dub” function used for creating two additional lanes for overdub purposes in Loop mode.*

- Creating a new note lane using the “Dub” button can also be done on-the-fly while recording.

## The “New Alt” function

The “Alt” function creates additional record enabled note lanes on which you can record alternative takes. At the same time, the previous note lane will be muted. Only the most recently added note lane will play back.

**! Note that if Loop is activated and the Song Position Pointer is between the Locators, the clips between the Locators will be muted (instead of the lanes).**

Here are two examples where the “Alt” function has been used:

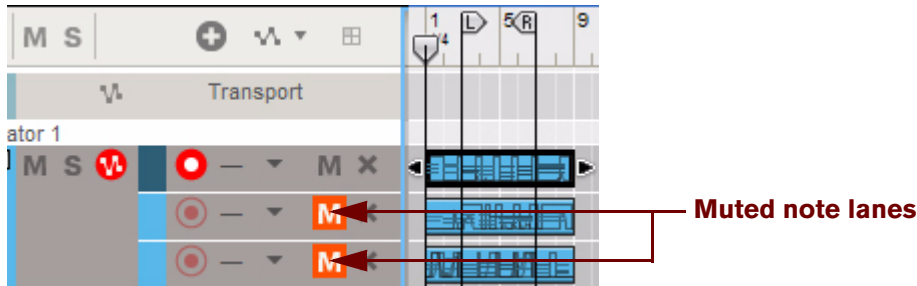

*The “Alt” function used for creating two additional lanes for alternative takes. Loop mode is Off.*

When using the “Alt” function with Loop mode off, the previous note lane will be automatically muted.

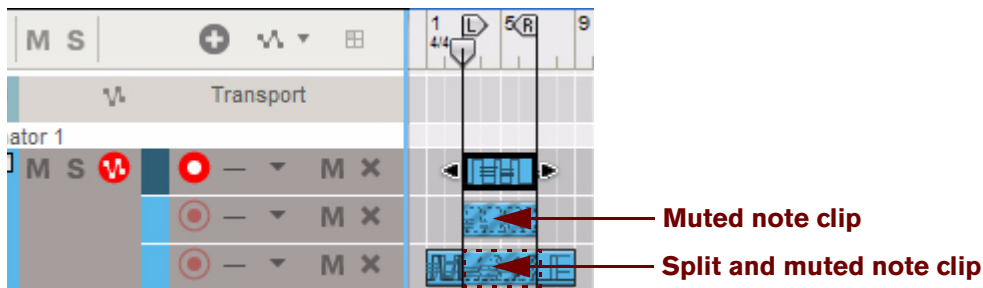

*The “Alt” function used for creating two additional lanes for alternative takes in Loop mode.*

When using the “Alt” function in Loop mode, the clips *between the locators* will be muted - not the entire note lane. If the locators are placed over an existing clip, as in the example above, clicking the “Alt” button in Loop mode will split the clip and mute the clip between the locators.

– **Creating a new note lane using the “Alt” button can also be done on-the-fly while recording.**

# Parameter automation recording details

In Reason, you can automate virtually any device and channel strip parameters and create completely automated mixes if you like. This is done by recording parameter events in the sequencer. It's also possible to record sequencer Tempo automation (see ["Tempo automation recording"](#)).

## Performance controllers vs. track parameter automation

Recording parameter automation can be done in two different ways; either as performance controller automation or as track parameter automation.

- **Performance controller automation is automatically recorded together with note events in note clips on note lanes.**  
Any standard MIDI performance controllers that you apply when playing (Pitch Bend, Mod Wheel etc.) will be recorded as performance controller automation in the note clip. A clip on a note lane can contain any combination of note events and performance controller automation events.
- **Track parameter automation creates separate parameter automation lanes on a track, one for each automated parameter.**

Which method you should use depends on how you prefer to work. The main differences to take into account are the following:

- **Performance controller automation allows you to contain the automation data in a note clip together with note events.**  
The key feature with performance controller automation is that it's contained together with the notes in the note clip. Moving the note clip moves the performance controller automation as well. Therefore, if your controller changes are part of your "note performance" (e.g. Pitch Bend and Sustain Pedal), then you want them as performance controllers (see ["Recording performance controller automation"](#)).  
Filter sweeps played together with the notes etc. can also be recorded as performance controllers (see ["Recording parameter automation into Note Clips"](#)).
- **If your parameter changes are for sound design or mixing purposes (e.g. a slow opening of a filter, a gradual change in level), they would probably work better as track parameter automation.**  
Track parameter automation is recorded on separate lanes on the track (one lane for each automatable parameter). Track parameter automation clips can be moved individually, independent from any note clips. See ["Recording parameter automation"](#).



# Recording performance controller automation

If you use any MIDI performance controllers when recording on a note lane, these are automatically added to the recorded clip. This makes sense as performance controllers are usually recorded at the same time you record notes, as a part of the performance. Standard MIDI performance controllers are Pitch Bend, Modulation Wheel, Sustain Pedal, Aftertouch, Breath Control and Expression.

- **To record standard performance controller automation, just follow the descriptions in “Recording notes”.**

When you have recorded performance controllers in the note clip, the clip will have automation curves visible in it along with the recorded note data.



Performance controllers are shown as curves in the note clip. In this picture, Mod Wheel, Pitch Bend and Sustain Pedal controllers have been used.

Green borders will appear around the automated device parameters to indicate that they are automated.



The Pitch Bend and Mod Wheel parameters have been automated, indicated by the green borders.

- ! **After you stop recording, you need to click Stop again, or click the “Automation Override” indicator to the right on the Transport Panel, for the green automation borders to appear on the device panel.**



The Automation Override indicator on the Transport Panel.

The performance controller automation is shown differently in the clip depending on the type of controller used. Controllers with bipolar range (such as Pitch Bend) are shown as lines in the middle when at zero (no pitch bend) with curves travelling up or down from the zero value. Controllers with only positive values (such as Mod Wheel) have zero at the bottom of the clip with applied modulation shown as curves travelling up from the zero value. Controllers with off/on values (such as Sustain Pedal) are shown as rectangular curves (on - duration- off).

- **If you open a note clip in Edit Mode (by double-clicking on the clip), the recorded performance data will show up on separate Performance Controller Edit Lanes on the Edit Pane.**

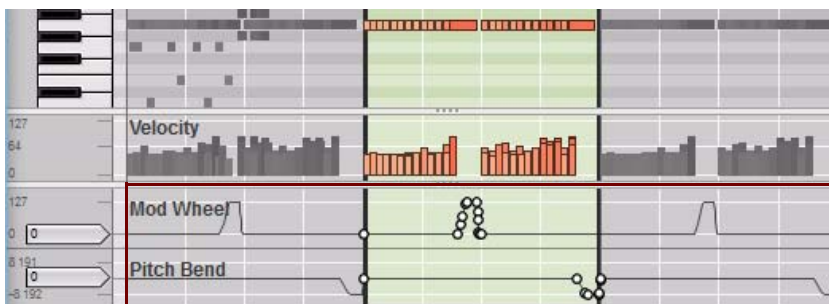

Performance Controller Edit Lanes

Performance controller automation on separate Edit lanes in Edit Mode.

- Note that you can record notes and performance controllers separately. I.e. you can first record notes on one note lane and then record performance controllers on another note lane on the same instrument track. The automation will be contained in note clips placed on a separate lane and can also be moved or muted separately.
- ! If several note lanes contain performance controller automation, the topmost lane has priority (see [“About performance controller automation on multiple lanes”](#)).
- It’s also possible to manually insert performance controller events by drawing events with the Pencil tool. Refer to [“Drawing parameter automation events”](#).

## Recording parameter automation into Note Clips

Besides the standard performance controllers (Pitch Bend, Mod Wheel etc.), you can choose to record automation of any type of instrument device parameter into a note clip:

1. Select **“Record Automation into Note Clip”** from the Options menu.

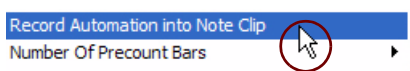

2. While recording on a note lane according to the description in [“Recording notes”](#), tweak the parameter(s) you want to automate on the instrument device panel in the rack - or use a Remote MIDI controller (see [“Remote - Playing and Controlling Devices”](#)).

Any parameter you tweak on the device will be recorded as automation inside the note clip - just like Performance Controller automation.

Green borders will appear around the automated device parameters to indicate that they are automated.

- ! After you stop recording, you need to click Stop again, or click the **“Automation Override”** indicator above the audio meters on the Transport Panel, for the green automation borders to appear on the device panel.
- While this method is perfect for making a note clip self-contained, there are some trade-offs. If you use this method to record device parameters, you won’t have the same overview as with track parameter automation. You also won’t be able to later mute a separate parameter automation lane, or move to parameter lanes independently.
- ! It is possible to have overlapping track parameter automation and automation inside a note clip for the same parameter. In such a case, the track parameter automation overrides the note clip automation. As soon as the track parameter automation clip ends, any automation inside the remaining part of the note clip takes over.

## Recording performance controller automation over or into an existing clip

- If you record over a note clip with performance automation data and you adjust any of the performance controllers used in the clip, the automation will be replaced with new performance events from this point onward until you stop recording.

However, if the new recording should start before the original clip’s start position, a new clip will be created which will incorporate the original clip. The new automation data will replace the existing one, but any existing note events will not be affected (see [“Recording parameter automation over or into an existing clip”](#) and [“Recording over or into an existing note clip”](#)).

## About performance controller automation on multiple lanes

If you have several active (un-muted) note clips with performance controller automation on different lanes of the same track, and these note clips overlap position-wise, the following rule applies:

- **Performance controllers in clips on the topmost lane override performance controllers of the same type in other overlapping clips on lanes below:**

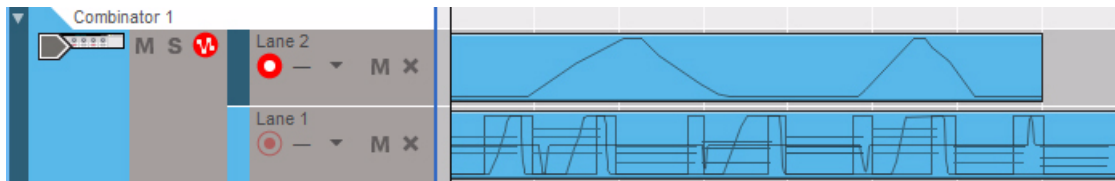

The clip on Lane 2 has Mod Wheel automation, and the clip on Lane 1 also has Mod Wheel automation - plus Pitch Bend and Sustain Pedal automation and note events. The Mod Wheel automation affecting the notes will follow the automation curve of the clip on Lane 2 for its duration. As soon as the clip on Lane 2 ends, the notes will be affected by the Mod Wheel automation in the clip on Lane 1.

## Recording parameter automation

Parameter automation is the standard way to automate device and channel strip parameters. Each automated device/channel strip parameter will generate a separate automation lane on the track. It's also possible to record automation of the Tempo on the Transport Panel. This is described in detail in ["Tempo automation recording"](#).

### Before you start recording parameter automation

Before you start recording automation of a device/channel strip parameter, you may want to set it to a suitable start value, what we call its "static value". By static value we mean the value the parameter should have whenever it is not automated in the song. Here is why:

Let's say you want to create a fade-out by recording a fader movement in a mixer channel strip. It's a good idea to first set the fader to the correct static value (i.e. the value the fader should have before you start the fade-out). The same thing is true if you want to create a filter sweep somewhere in the song: first set the filter frequency to the value it should have elsewhere in the song, then record the filter sweep. This makes it possible to set up a static mix first, and then add some automated parameter changes anywhere in the song while maintaining the static values elsewhere in the song.

You can think of the static value as a "default" or "fall-back" position for the duration of the song.

- **You can change the static value at any time, by opening the automation clip in Edit Mode. See ["Editing parameter automation in Edit Mode"](#).**

## Parameter automation recording procedure

### 1. Make sure there is a sequencer track for the device you're going to record parameter automation for.

For audio track devices and for instrument devices, a sequencer track is automatically created together with the device. For mix channel and effect devices, that might not necessarily have a sequencer track, the easiest way to create a track for parameter automation is by right-clicking (Win) or [Ctrl]-clicking (Mac) on the device/channel strip parameter and selecting "Edit parameter Automation" from the pop-up.

### 2. Set up the track for parameter automation recording according to the description in "Record enabling parameter automation".

If the track has note lanes you may want turn off the "Record Enable" button for the active note lane (unless you plan to record notes and parameter automation simultaneously of course).

### ! Note that it is not necessary for the track to be selected, or for the track to have Master Keyboard Input, to be able to record parameter automation. The "Automation Record Enable" button is completely independent from Master Keyboard Input. However, if you want to adjust the parameters from a control surface or MIDI Controller keyboard, this is most easily done by setting Master Keyboard Input to the track - see "Setting Master Keyboard Input".

### 3. Record the track according to the description in "General recording procedure".

### 4. Record the parameter automation by changing device/channel strip parameter(s) in the rack or in the mixer.

During recording, adjust the desired parameter(s), from the device panel or from a MIDI control surface. You can automate any parameter for the device - each parameter you tweak will automatically generate a separate parameter automation lane and a clip will be recorded on the corresponding lane from the point you changed the parameter.

- It is also possible to record automation of the channel strip EQ and Filter parameters from the Spectrum EQ window, see "The Spectrum EQ Window".

### 5. When you're done, click the "Stop" button on the Transport Panel to stop recording.

In the Song View or Blocks View, the parameter automation clip(s) on the lane(s) show the recorded parameter automation events as curves or lines inside the clip.



Parameter automation clip with parameter events

If you click the "Stop" button again, or click the "Automation Override" indicator on the Transport Panel, the automated parameters on the device(s) will be marked with green borders, indicating that they have been automated.

If you play back the recorded section again, the automated parameters will change automatically. Outside the clip boundaries, the parameters will have their original settings (the static values they had before you started recording).

- It's also possible to manually insert parameter automation events by drawing events with the Pencil tool. Refer to "Drawing parameter automation events".

## Recording parameter automation in Loop mode

Recording parameter automation events in Loop mode works similar to "non-looped" recording (see "Recording parameter automation"), except that for every new loop cycle any changed parameter value will replace the previously recorded value for the corresponding parameter.

## Recording parameter automation over or into an existing clip

Recording parameter automation events over or into an existing automation clip will simply replace the previously recorded automation events. However, if the new recording should start before the start position of the original automation clip, and expand into the original clip, the new clip will merge with the original clip. After the new clip ends, the parameter automation in the original clip will “take over”.

If you need to redo a section of the recorded automation in an existing clip, or simply record more automation for a parameter, proceed as follows:

**1. Set up and start recording in the same way as described in “Parameter automation recording procedure”.**

As long as you don’t change the parameter value, its automation data will be played back normally, and nothing will be changed.

**2. At the desired position, adjust the parameter.**

As soon as you start changing the parameter value, the Automation Override indicator will light up on the transport panel.



*The Automation Override indicator on the Transport Panel.*

From this point on, the previously recorded automation values will be replaced with the new automation values. Automation recording is different from recording note events where nothing is erased when you record over previously recorded clips. A parameter automation “overdub” will replace any previous automation values at the same position for the duration of the recording. Automation clips logically cannot be “overdubbed” as a parameter cannot have more than one specific value at a given point in time.

**3. When you’re done, click the “Stop” button on the Transport Panel to stop recording.**

You have now replaced the automation values from where you started recording to where you stopped recording. The Automation Override indicator will still be lit but it will go off if you click Stop or Play on the Transport Panel.

**→ You can also click the “Automation Override” indicator during recording.**



This “resets” the parameter to the previously recorded value and the automation recording will stop (making the previously recorded automation active again, from that position). You are still in record mode, so as soon as you adjust the parameter again, the Automation Override indicator will light up.

## Adjusting automated parameters during playback - “Live mode”

Even if you have automated a device/channel strip parameter, you can still “grab it” and adjust it during playback, overriding the recorded automation:

### 1. During playback, adjust an automated parameter.

The Automation Override indicator lights up on the Transport Panel.



From this point onward, the recorded automation for the parameter is temporarily disabled.

### 2. To activate the previously recorded automation again, click the “Automation Override” indicator.

This returns the control of the parameter to the parameter automation lane in the sequencer.

- **Note that you can also temporarily turn off automation for a parameter by clicking the “On” button (so that it goes dark) on the parameter automation lane in the sequencer (see “Muting a parameter automation lane”).**

## Recording parameter automation on multiple tracks

Although only one track can have Master Keyboard Input, it is possible to record enable any number of tracks for automation recording.

### → Activate the Record Enable Parameter Automation button for all the tracks you wish to record automation for.

When recording is activated, all automation record enabled tracks will record track parameter changes from their respective devices in the rack. This is especially useful if you have assigned parameters on several devices to a single control on a MIDI control surface, or have multiple control surfaces controlling different devices in the rack while you’re recording. See “Remote - Playing and Controlling Devices” for details.

# Pattern automation recording details

If your song contains pattern based devices such as the Redrum Drum Computer, Matrix Analog Pattern Sequencer or Dr. Octo Rex, you probably want to use more than a single pattern throughout the song. To facilitate this you can record pattern changes in the sequencer.

## Recording pattern automation

1. **Before you start recording on the track, make sure the “Record Enable Parameter Automation” button is on (red).**

You can disable the “Record Enable” button for the note lane for now as it won’t be needed.

2. **Make sure that the “Enable Pattern”/”Enable Loop Playback” button is activated on the device in the rack.**



The “Enable Pattern” buttons on the Redrum (top) and Matrix (bottom) devices.

3. **Set the desired start pattern on the pattern device.**

4. **Start recording on the track from the desired position.**

When recording starts, the pattern device will automatically start. Although no clip will be created until you change pattern on the device for the first time, the start pattern is still being recorded.

5. **During recording, change patterns with the “Bank” and “Pattern” buttons on the device panel.**

As soon as a Pattern or Bank value is changed on the device, a pattern lane is automatically created on the track. On the lane, a pattern clip is automatically created and the pattern selection is recorded in the clip. Make sure you change the patterns slightly in advance - the actual pattern change will be recorded (and happen) on the next downbeat according to the sequencer time signature setting.

6. **When you are done, click “Stop” on the Transport Panel to stop recording.**

The automated pattern selection buttons on the device in the rack will be marked with a green border, indicating that they have been automated. A pattern automation lane with pattern clips has also been created on the Edit/Arrangement Pane.

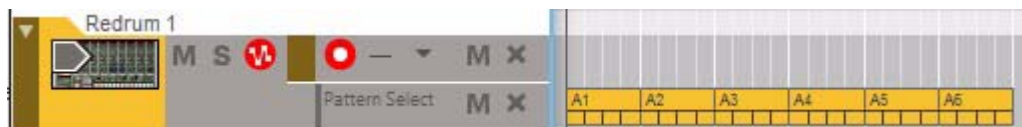

Pattern automation clips on the pattern automation lane.

- **Pattern automation has no “static value”. Patterns will only be played back where there are pattern clips on the lane. Where the pattern lane has no clips, the device will stop and no pattern will be played back.**

- **Each pattern change will be recorded on a downbeat (at the start of a new bar in the sequencer).**  
You can move pattern changes to other positions by moving or resizing the pattern clips, see [“Editing pattern automation”](#).
- **You can “punch in” on recorded pattern changes, to replace a section of the pattern lane with new pattern automation events. This can be done the same way as described in [“Recording parameter automation over or into an existing clip”](#).**
- **After recording the pattern changes, you can use the function “Convert Pattern Track to Notes”, to transfer the notes in the patterns to regular notes in the main sequencer.**  
This allows you to create unlimited variations by later editing the notes in Edit mode. See [“The “Convert Pattern Automation to Notes” function”](#).
- **On the Redrum, Matrix and Dr. Octo Rex devices, you could also use the “Copy Pattern/Loop to Track” function.**  
This function lets you convert a defined range of pattern clips into notes in a new note clip. See [“Copy Pattern to Track”](#).
- **You can also manually draw automation clips on the Pattern automation lane - see [“Drawing pattern automation”](#)**

## Tempo automation recording

In Reason it's possible to record automation of the sequencer's tempo. This means that a song can automatically change tempo whenever you like. You can record tempo automation events on the parameter automation lanes on the Transport track.

### Recording tempo automation

Automating tempo is done much in the same way as with other parameter automation. You record the tempo changes by changing the Tempo value on the Transport Panel. When you later play back, audio clips will automatically be stretched to follow the tempo changes (unless you have disabled stretch for the clips - see [“About disabling Stretch for audio clips”](#)). Note clips and automation clips will always follow tempo changes.

To record tempo automation, do as follows:

**1. Set the desired song tempo in the Tempo display on the Transport Panel.**

This will be your static value, i.e. the tempo of the song wherever there is no clip present on the tempo automation lane.

**2. Press [Alt](Win) or [Option](Mac) and click in the Tempo display on the Transport Panel.**

This will both select the Transport track and create a Tempo automation lane at the same time. The Tempo display will also be marked with a border, indicating that the Tempo parameter has been automated.

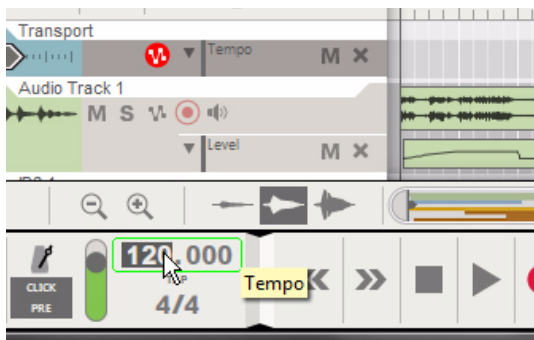



**3. Start recording in the sequencer and record the tempo changes by changing the value in the Tempo display.**

Click and drag up/down in either of the display segments to change tempo in BPM steps or 1/1000 BPM steps.

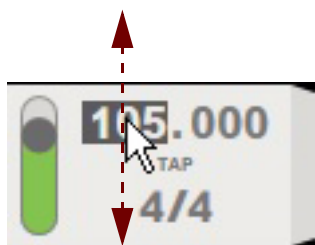

or

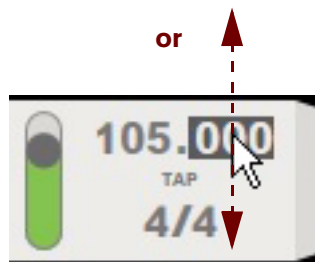

- You can also manually draw Tempo automation events in the parameter automation clip, using the Pencil tool  
- see **“Drawing tempo automation events”**.



# **Chapter 7**

## **Arranging in the Sequencer**

# About this chapter

This chapter describes how you can arrange and work with the clips in your song. The chapter covers both audio, note and parameter automation clip arrangement. Special arrangement techniques pertaining to the Blocks View are described in the separate chapter “Working with Blocks in the Sequencer”.

Before reading this chapter, it’s recommended that you are familiar with the sequencer functions and definitions described in the “Sequencer Functions” and “Recording in the Sequencer” chapters.

## Clip handling

Clip arrangement in the sequencer is done mainly in the Song View - but could also be done in Edit Mode, if the clips you’re arranging are on the same lane. The descriptions in this chapter refer to arrangement in the Song View, unless otherwise stated.

## Creating Clips

Clips are created automatically when you record, but you can also create empty clips and add notes and other events in them by drawing with the Pencil Tool.

- **To create a clip, double click with the Selection (Arrow) Tool on a track.**  
This will create an empty clip with the length of the current Snap value setting (e.g. 1 bar). To create longer clips, double click, keep the mouse button pressed and drag to the right.
- **You can also create clips by selecting the Pencil Tool and drawing on a Lane in the sequencer.**

## Selecting clips

- **To select any type of clip in the Song View, just click on it.**  
A selected clip is indicated with a thick black border with Clip Resize handles on either side. In Edit Mode, the Clip Resize handles appear in the Clip Overview area.

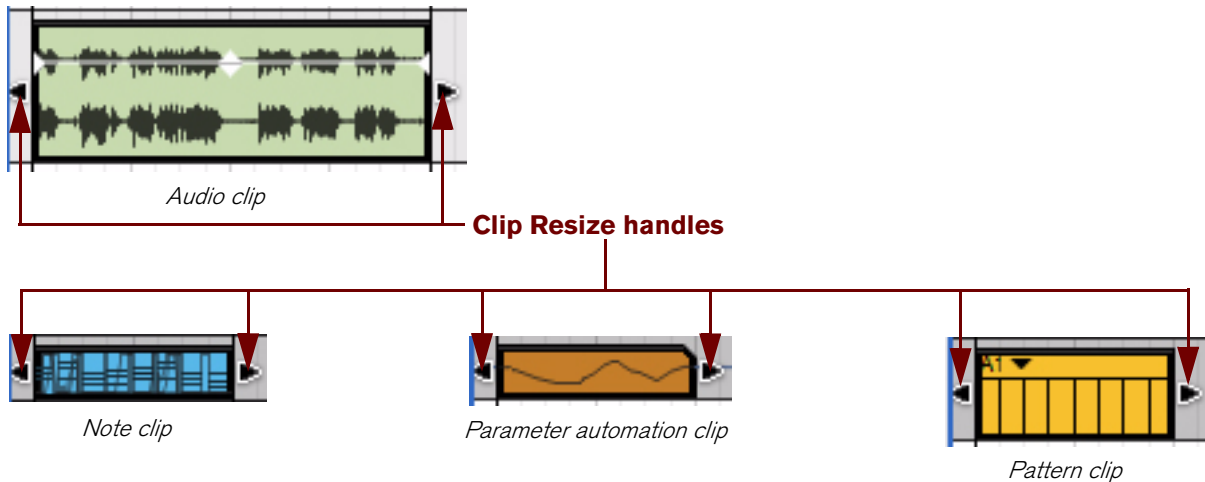

*Selected clips in Song View.*

- **To de-select clips, just click anywhere on the Arrange Pane background.**

## Inspector displays for selected clips

In the sequencer Inspector, the Position and Length displays shows the start position and length of the selected clip. For selected audio clips, four additional displays are shown: Fade In, Fade Out, Level and Transpose. If several clips are selected, the displays show the values for the earliest (or topmost) selected clip in the song.

Position	Length	Fade In	Fade Out	Level (dB)	Transpose
2. 1. 1. 0	8. 0. 0. 0	0. 0	0. 0	0.00	0.00

*The Inspector displays for selected Audio Clips.*

- **Clip Position display**  
The clip Position display shows at what position in the song the clip begins. The display readout is divided into Bar, Beat, 1/16 Note and Ticks (1/16th note=240 Ticks). The position can be edited according to the descriptions in ["Moving clips using the Inspector"](#).
- **Clip Length display**  
The clip Length display shows the length of the clip. The display readout is divided into (from left to right) Bar, Beat, 1/16 Note and Ticks. The length can be edited according to the descriptions in ["Resizing clips using the Inspector"](#).
- **Fade In and Fade Out displays (audio clips only)**  
The Fade In and Fade Out displays for selected audio clips show the Fade In and Fade Out times for the audio in the clip. The readout is divided into 1/16 Note and Ticks. The Fade times can be edited as described in ["Inspector segment displays"](#).
- **Level display (audio clips only)**  
The Level display for selected audio clips shows the level of the audio in the clip. The readout is divided into dB and 1/100 dB. The level can be edited as described in ["Inspector segment displays"](#).
- **Transpose display**  
The Transpose display shows the transposition of the audio recordings in the selected Audio Clip(s) - relative to the original pitch. The display readout is divided into (from left to right) Semitones and Cents, See ["Transposing Audio Clips"](#).

## Selecting multiple clips

In Song View, several clips can be selected, e.g. for cutting, copying, pasting, deletion, moving or resizing purposes.

### → Press [Ctrl](Win) or [Shift](Mac) and select the clips.

Under Windows, you can also press [Shift] and click to select a range of clips on the same lane.

- Draw a selection rectangle with the Selection Tool (arrow) on the Arrange Pane background.

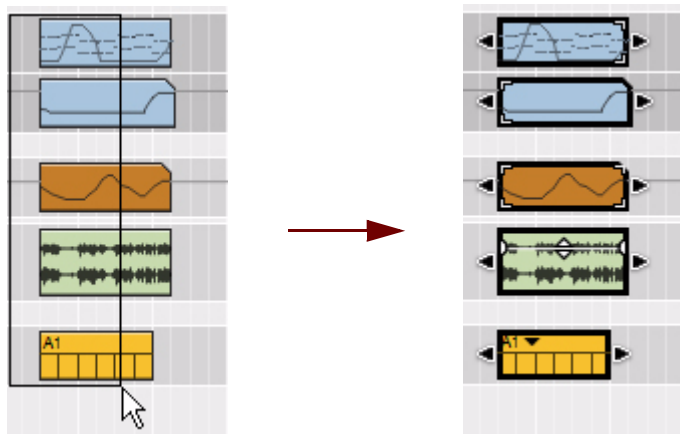

*Click, hold and draw a rectangle with the Selection Tool to select multiple clips.*

All clips that are touched by the selection rectangle will be automatically selected when the mouse button is released.

- **If you hold down [Shift] when you select clips with the selection rectangle technique, any previously selected clips will remain selected.**  
This allows you to make multiple, non-contiguous selections: first select some clips, then hold [Shift] and select some more clips, and so on.
- **Use the “Select All” function on the Edit menu or on the clip context menu to select all clips in the song.**  
Alternatively, hold down [Ctrl](Win) or [Cmd](Mac) and press [A].
- **You can also select multiple clips in the Clip Overview area in Edit Mode - if the clips are on the same lane.**

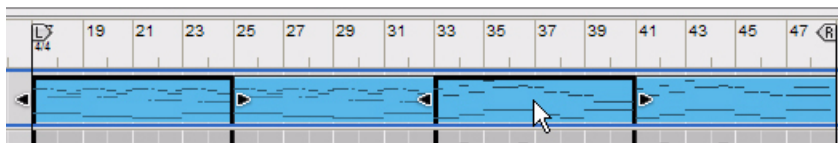

*Two selected clips in the Clip Overview area in Edit Mode.*

## Selecting clips with the arrow keys

Another way of selecting clips on the Arrange Pane is to use the arrow keys on the computer keyboard.

- Press the [Left] or [Right] arrow keys to select the previous or next clip on the lane.
- Press the [Up] or [Down] arrow key to select the closest clip on the lane above or below.
- Hold down [Shift] and use the [Left]/[Right] arrow keys to make multiple selections on the same lane.

## Setting audio clip Level and Fades

Besides the Clip Resize handles, a selected audio clip also has Fade In and Fade Out handles plus a Clip Level handle. These can be edited at any time, either by using the handles as described below, or using the Inspector as described in “[Fade In and Fade Out displays \(audio clips only\)](#)” and “[Level display \(audio clips only\)](#)”:

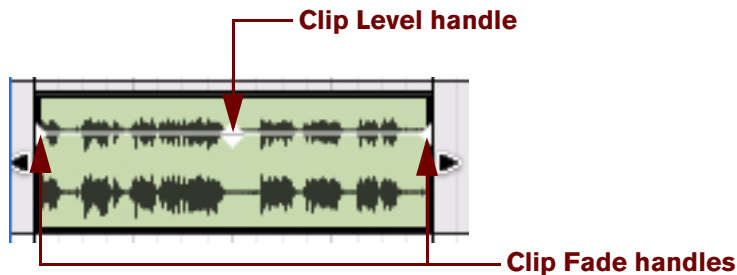

*A selected audio clip in Arrange Mode.*

### Fade In and Fade Out Handles

- **Click and drag these handles horizontally to introduce a fade in and/or fade out of the audio in the clip.**

The Fade settings can be set individually for each audio clip in the song. The fading is non-destructive and can be changed at any time. If Snap is activated (see “[Snap](#)”), the set Snap value is taken into account when setting the fade time(s).

### Clip Level Handle

- **Click and drag this handle vertically to adjust the audio level in the audio clip.**

The Level can be set individually for each audio clip in the song. The Level setting is non-destructive and can be changed at any time.

## Deleting clips

- **To delete a clip, select it and press [Delete] or [Backspace] or select “Delete” from the Edit or context menu.**  
You can also draw selection rectangles with the Selection tool, encompassing several clips and delete them all at once. The same rules apply as when selecting clips (see “Selecting clips”).
- ! **If you delete an audio clip which contains recordings that are not used elsewhere in the song, those audio recordings will be permanently deleted! However, if you accidentally erase an audio clip, you can always use the “Undo” function.**

### Deleting clips with the Eraser tool

You can also use the Eraser tool to delete clips on the Arrange Pane. The Eraser tool can be used in two ways: you can click on single clips or you can make a selection rectangle encompassing several clips:

- **Select the Eraser Tool and click on the clip you want to delete.**

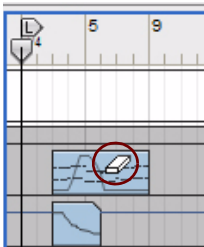

*Select the Eraser Tool and click on the clip you want to delete.*

Alternatively, if you want to delete multiple clips:

- **Select the Eraser Tool, click and hold the mouse button and draw a selection rectangle on the Edit/Arrange Pane background.**

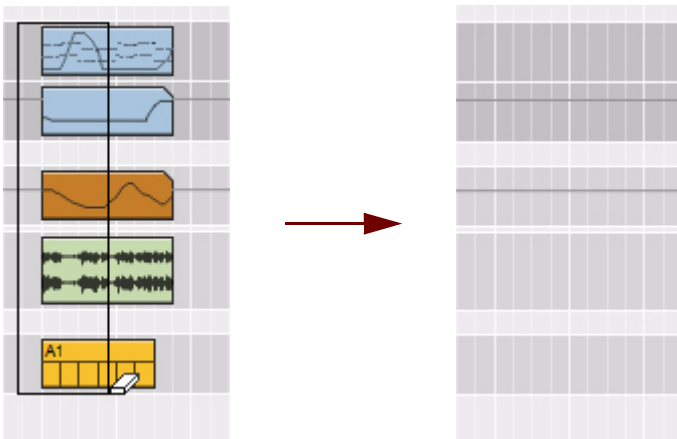

*Click, hold and draw a rectangle with the Eraser Tool to erase multiple clips.*

All clips that are touched by the selection rectangle will be deleted once you release the mouse button.



## Resizing (masking) clips

All clip types can be resized by clicking and dragging either of the Clip Resize handles on the selected clip(s). This can be done both in the Song View and in Edit Mode. In Edit Mode, the Clip Resize handles appear in the Clip Overview area.

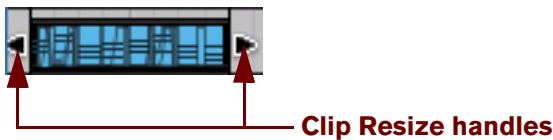

*A selected note clip.*

If you resize a clip and make it smaller, any recordings or events that now lie outside the clip boundaries will not sound, or have any effect, when played back. However, they are not deleted - just masked. If you make the clip larger again, the recordings or events that were masked will become visible and will play back again. See [“About masked recordings and events”](#).

If you enlarge an unmasked clip, nothing special will happen except that the clip “window” becomes larger.

- **If you resize an audio clip which uses Fade In and/or Fade Out, the fade slopes will follow along, unaffected, with the clip boundaries.**

## Resizing multiple clips

It's possible to resize several clips by first selecting the clips, and then dragging a Clip Resize handle on one of the selected clips. All selected clips will be resized by the same amount.

## Resizing clips using the Inspector

Another way of resizing clips is to change the clip length(s) in the Inspector. This can be done in the following way:

- **Select one or several clips on the Arrange Pane and then change the Length value in the Inspector by clicking on the up/down arrow buttons.**

In the example below, we expand the clip lengths by 2 bars by clicking the up arrow button twice.

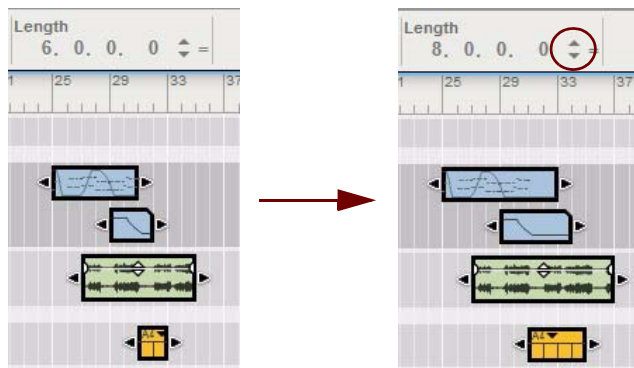

All selected clips become 2 bars longer.

- See [“Inspector segment displays”](#) for more details on how to edit in the Inspector displays.
- **If the Tick segment in the Length display shows an asterisk (\*), it means that the value is a fraction of a Tick - a subtick. See [“About subticks in the Position and Length displays”](#) for more info.**

## About masked recordings and events

A note or parameter automation clip which contains masked events is indicated by white corners on the left, right or both clip boundaries:

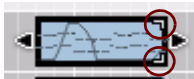

The position of the white corners indicate on which side of the clip boundary the masked events exist:

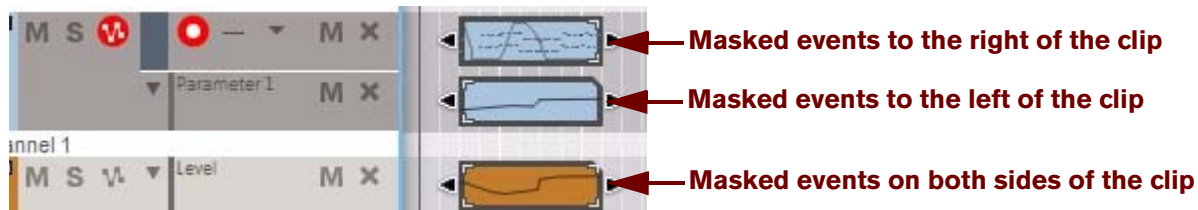

**! Audio clips don't have any indication if they contain masked recordings.**

## Masked recordings in audio clips

If you resize an audio clip and make it smaller, the masked part of the recording will be silent during playback. If you open a masked audio clip in the Comp Editor, the part of the recording that will actually play back is shown in the Clip Overview area. The masked part of the recording will appear grayed out on a Comp Row:

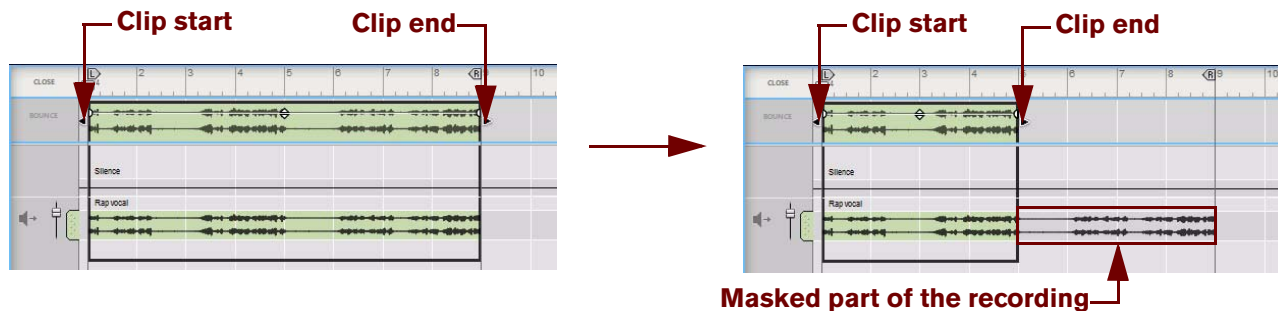

*An open audio clip before and after masking.*

## Masked events in note and parameter automation clips

In the picture below is an open note clip in Edit Mode with notes and performance controller events, before and after resizing the clip:

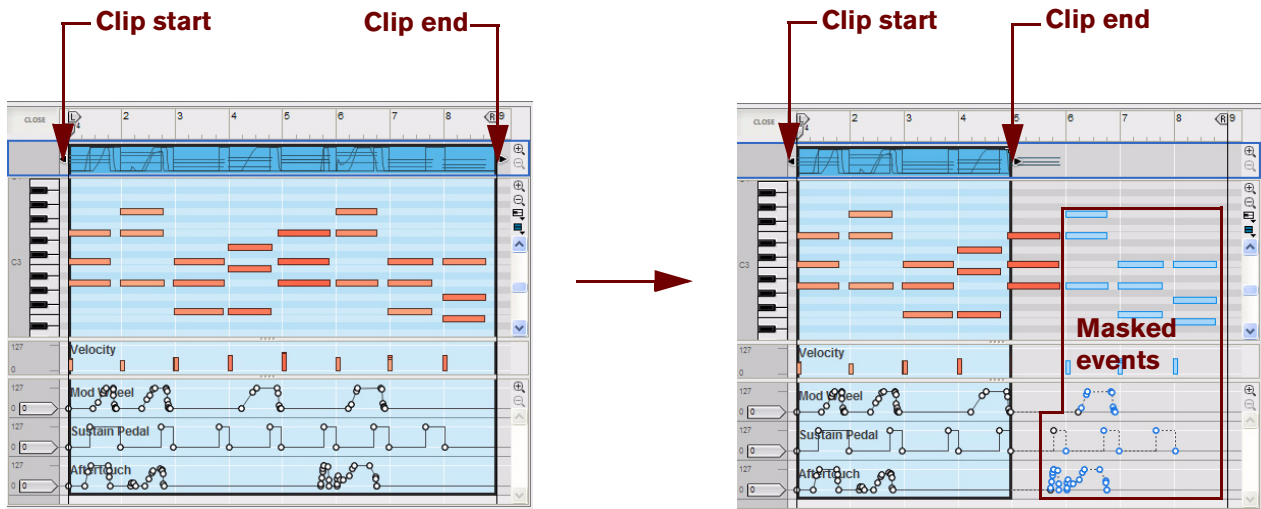

*An 8-bar note clip with notes and performance controller events.*

*The same note clip resized to 4 bars*

After resizing the clip from 8 to 4 bars, all events that begin in bars 5-8 are now masked and won't play back. All masked events will still be there - and follow along with the clip if the clip should be moved, cut or copied.

Masked events will be a blue color on the Note Edit Lane, to indicate that they won't play back. The first three-note chord in the masked area is still an orange color. That's because the notes begin in bar 4 (just before the downbeat) and thus will play back in their entirety, also after resizing the clip.

Masked performance controller events, parameter automation events and pattern automation events will be inactive - but could still affect the masked clip (see ["About masked performance controllers and automation events"](#) below). Outside a masked clip, the controller/parameter/pattern values will default to their Static Values in the masked area (see ["Static Value Handles"](#)).

**! Note that just switching to Edit Mode won't show masked events. A clip has to be opened before you can view these events. You can remove all masked note and parameter automation events using the "Crop Events to Clips" function on the Edit menu (see ["The "Crop Events to Clips" function"](#)).**

## About masked performance controllers and automation events

Masked performance controller and parameter automation events just outside a clip can still affect the clip, since they affect the curve shape. The example below shows a masked note clip with Mod Wheel performance controller.

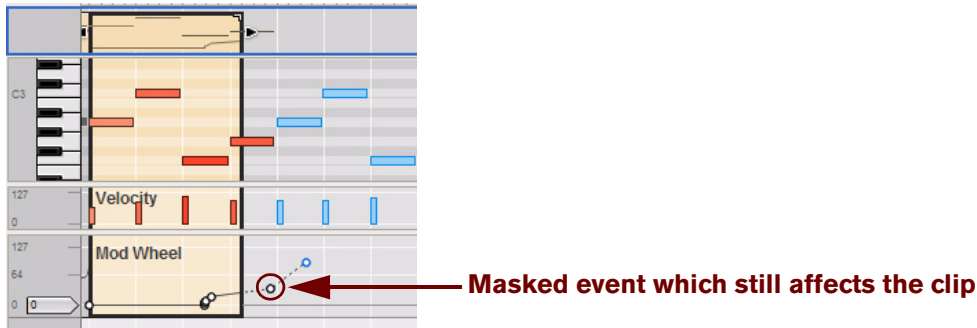

The first Mod Wheel automation event to the right of the masked part of the clip determines the direction of the automation curve from the last event in the unmasked area. These types of automation events are not blue, but black and white, just like unmasked events.

The result in this example is that the Mod Wheel value will continue to rise all the way to the end of the masked clip, at which point the value will drop down to the Static Value - in this case "0".

## The “Crop Events to Clips” function

There may be situations when you want to delete all masked events, i.e. events located outside the left and/or right clip boundaries. This function only works for note and parameter automation clips and will delete all masked notes that begin in the masked clip section, plus any performance controller or parameter automation events:

1. Reduce the size of the clips to your liking.
2. Select one or several clips and choose “Crop Events To Clips” from the Edit menu or from the context menu.
3. After the cropping operation, all events outside the clip have been deleted.

## Tempo scaling clips

It is possible to tempo scale the content of clips, i.e. make the clip play back at faster or slower tempos. This can be achieved in two different ways:

- By manually stretching selected clip(s).
  - By editing the tempo scaling numerically in the Tool Window.
- ! Tempo scaling can be applied to all clip types, except for Time Signature automation clips.
- ! Note that Pattern Automation Clips will only be resized - the pattern tempo in the source device will NOT be scaled but will still be synced to the main sequencer tempo!

Below, we will describe how to use the “scale tempo” tool to manually stretch clips. Numerical tempo scaling in the Tool Window is explained in “Scale Tempo” in the “Note and Automation Editing” chapter.

1. **Select one or several clips, either on the arrangement pane in Song/Blocks View, or in the Clip Overview in Edit Mode.**
2. **With the Arrow Tool selected, hold down [Ctrl](Win) or [Option](Mac) and place the mouse cursor over one of the Clip Resize handles.**

When you reach any of the Clip Resize handles, the arrow symbol switches to a “scale tempo” arrow.

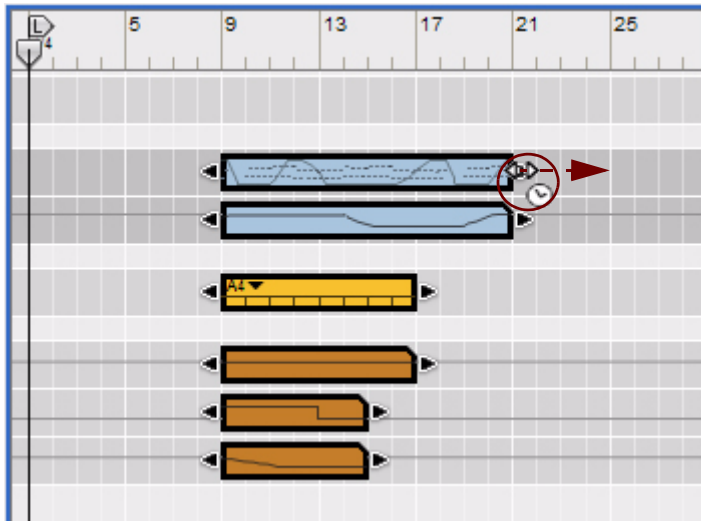

3. **Hold down [Ctrl](Win)/[Option](Mac) and click and drag the cursor sideways in either direction to scale the tempo of the clip contents.**

In this example, we make the “stretched” clip four bars longer by dragging the right clip handle one bar to the right.

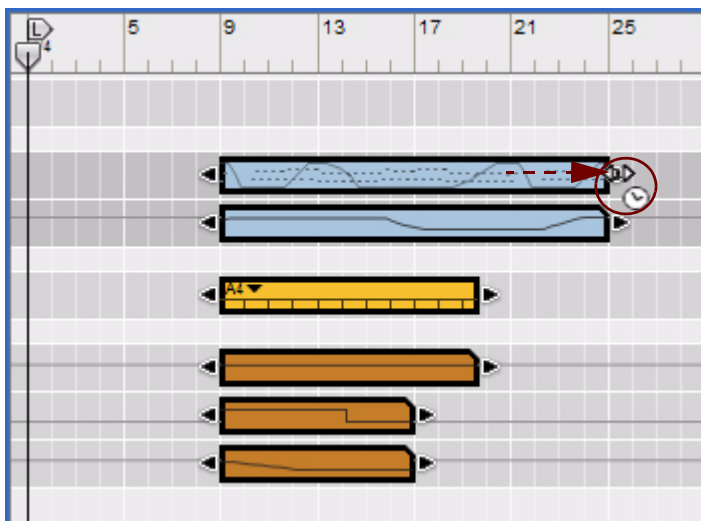

Now, all clips have been tempo scaled and the clip content have been stretched to match the new clip length. Note that the content of all selected clips have been scaled proportionally. The Pattern Clip has only been resized, though. The pattern tempo in the source device has NOT been scaled.

For more details about tempo scaling audio clips, refer to “Tempo scaling Clips” in the “Audio Editing in the Sequencer” chapter.

# Moving clips

## Moving clips on the same lane

- **To move a clip, drag and drop it to the desired destination on the lane.**

It's also possible to select and move several clips by dragging and dropping them at the desired destination. If the Snap function is selected (see “Snap”), you will only be able to move the clip(s) in steps of the selected Snap value.

- **You can also use the “Cut” and “Paste” functions on the Edit menu or context menu to cut the selected clip(s) and then paste them at the current Song Position Pointer position (see “Cutting, Copying and Pasting clips”).**

## Nudging clip positions

You can use the left and right arrow keys on the computer keyboard to “nudge” the positions of selected clips in a couple of different ways:

1. **Select the Snap value by which you want to nudge the clip(s).**

2. **Press [Ctrl](Win) or [Cmd](Mac) and use the Left and Right arrow keys to move the clip position back or forward by the set Snap value.**

It doesn't matter if Snap is on or off - the clip will always be moved in steps of the set Snap value.

- **Press [Ctrl]+[Alt](Win) or [Cmd]+[Option](Mac) and use the left and right arrow keys to move the clip position back or forward in Tick increments.**

There are 240 ticks per 1/16 note so this is very fine editing - check the tick positions in the inspector when you nudge because typically you won't “see” the position changes unless you're working at a high zoom level.

- **Press [Ctrl]+[Shift](Win) or [Cmd]+[Shift](Mac) and use the left and right arrow keys to move the clip position back or forward in Beat increments.**

## Moving clips using the Inspector

Another way of moving clips is to change the clip position in the Inspector. This can be done in the following way:

- **Select one or several clips on the Arrange Pane. Then, change the Position value in the Inspector, either by clicking on the Up/Down spin controls, or by using any of the methods described in “Inspector segment displays”.**

In this example, we move the clips position 2 bars forward by clicking the “Up” spin control twice.

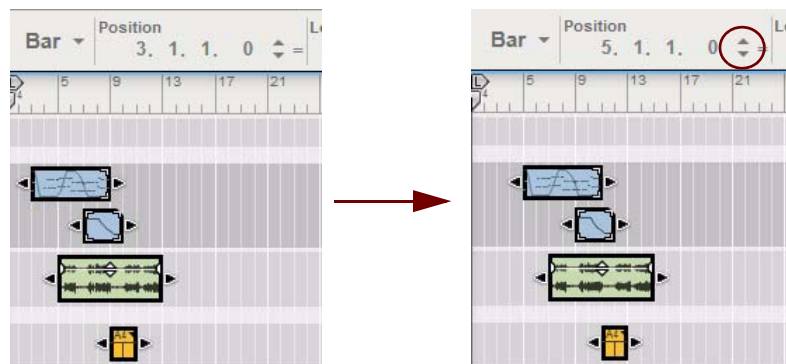

All selected clips are moved forward by 2 bars.

- **If the Tick segment in the Position display shows an asterisk (\*), it means that the value is a fraction of a Tick - a subtick. See “About subticks in the Position and Length displays” for more info.**

## Moving clips between lanes

You can move clips between lanes, either on the same track or between lanes on different tracks:

→ **Click and drag the clip(s) to the desired position on the new lane.**

The set Snap value is taken in to account if the function is activated (see “Snap”). It's also possible to move several selected clips in one go.

→ **Hold down [Shift] when you drag the clip(s), to restrict the clips to vertical movement.**

! **If you want to move several clips in the Windows version of Reason, press the [Shift] key after you have pressed the mouse button, otherwise pressing [Shift] will select or deselect clips, and that's not what we want here.**

! **For a successful result, it's important that the source and destination lanes are of the same, or similar, type (see “About alien clips” below).**

## About alien clips

An alien clip is a clip containing types of event, or different parameter range/resolution, other than that the lane is intended for. For example, if we move a note clip from a note lane to a parameter automation lane, the note clip would become alien and won't play back on the automation lane:

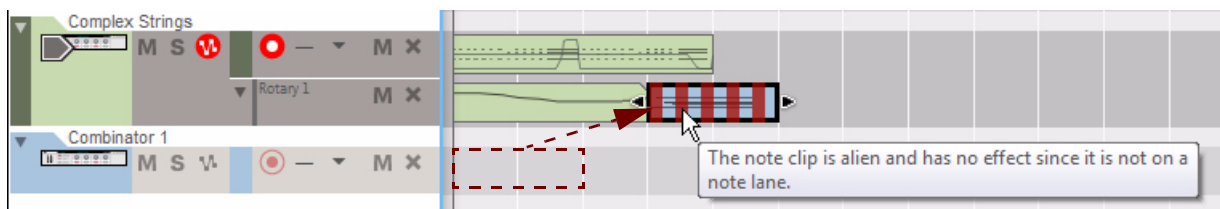

*If a note clip is moved from a note lane to a parameter automation lane, for example, the clip becomes alien.*

An alien clip can be distinguished by its red stripes, which indicate that the clip is currently inactive. If you place the cursor over an alien clip, a tool tip appears with detailed information:

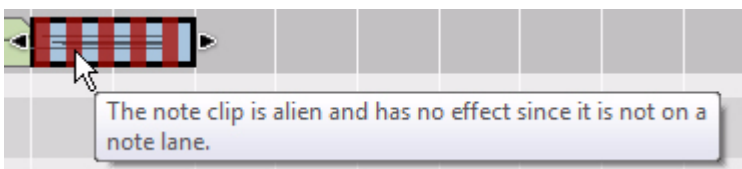

*Tool tip for an alien note clip.*

• **A parameter automation clip can also become alien if it is moved to a parameter automation lane for a parameter with a different range or resolution.**

In most cases, you can resolve this by first selecting the clip and then selecting “Adjust Alien Clips to Lane” from the Edit menu or from the context menu.

For example, if a parameter automation clip for a parameter that has a bipolar (-64 to 63) value range is moved to a parameter automation lane with a unipolar (0 to 127) value range, it will become alien. Selecting “Adjust Alien Clips to Lane” from the Edit menu or context menu will adjust the parameter automation events of the clip to fit the range of the parameter on the destination lane.

## Moving clips with performance controller automation to another track

If you move note clips that contain performance controller automation events to another track (for a different type of instrument device), there are a few things to note:

- **If you have only recorded standard performance controllers (Pitch Bend, Mod Wheel and Sustain pedal) in the note clip, these will usually translate without any problems when moved to another device track.**  
Be aware that all devices do not respond to all performance controllers - the Malström device, for example, does not respond to Aftertouch, Expression or Breath performance controller data.
- **If you have recorded non-standard controller parameters for a device in the note clip using the “Record Automation into Note Clip” option (see “Recording parameter automation into Note Clips”) some automated parameters may not have an equivalent parameter in the target device.**  
In such cases the automation data for an incompatible controller will simply be ignored.
- **Parameters common to most instrument devices (filters, envelopes etc.) will be transferred to the target device whenever applicable.**

## About overlapping clips

If you move or resize clips so that the clips overlap each other, the following rules apply:

- **Clips or sections of clips that are hidden (overlapped) will not play back.**  
Any lane can only play back a single clip at a time - if you want to mix two clips, put them on separate lanes (note clips) or on separate tracks (audio clips). See “Adding note lanes” and “Duplicating/copying tracks and devices”.
- **The clip with the latest start position have priority (and will be played back).**  
This means if a shorter clip is placed “in the middle” of a longer clip, as in the picture below, the sequencer will play the beginning of the long clip, then the shorter overlapping clip and then the end of the long clip.



- ! **If both clips start at the same position and have the same length, the clip which was moved last will sound. Consequently, the “hidden” clip won’t play back at all.**

## Duplicating clips

- **To duplicate selected clips, hold down [Ctrl](Win) or [Option](Mac), then click with the Selection Tool and drag a copy of the clip(s) to the desired destination.**  
As you begin dragging, the cursor displays a “+” sign next to it to indicate duplication.
- **You can use the Duplicate function ([Ctrl]/[Cmd]-[D]) to quickly make copies of clips, lined up after each other and spaced according to the Snap value.**
- **It’s also possible to duplicate only a part of one or several clips by using the Razor Tool as described in “Duplicating a part of one or several clips”**

## Cutting, Copying and Pasting clips

You can move or duplicate clips using the “Cut”, “Copy” and “Paste” commands on the Edit menu or the context menu. When you paste, the clips will end up at the current song position, on their original lane(s).

If you paste a clip into another Reason song document, the pasted clip will be placed on the track with edit focus, if possible. Typically, you can just select a track in the other document, place the song position pointer where you want, and paste the clip(s) onto the selected track.

New tracks will be created when necessary. Since all tracks must have a device associated with them, the new tracks will be associated with empty Combinator devices. You can then use the Patch browser on the Combinator to select a suitable patch and device type. The above rules also apply when pasting alien clips and parameter automation clips.



## Using Cut/Copy and Paste to repeat clips

When you cut or copy clips, the song position will automatically move to the end of the selection (or, if Snap is activated, to the closest Snap value position after the end of the longest clip). This allows you to quickly repeat a section of clips in the following way:

- 1. Make sure the sequencer is stopped.**
- 2. Activate Snap (see “Snap”) and set the Snap value to “Bar” (or to the length of the section you want to repeat).**
- 3. Select the clips you want to repeat.**  
Since you can select clips on several tracks, this is a quick way to copy entire song sections.
- 4. Select “Copy” from the Edit menu or context menu, or hold down [Ctrl](Win) or [Cmd](Mac) and press [C].**  
The song position is moved to the closest snap value after the end of the longest clip in the selection (provided that the sequencer is stopped).
- 5. Select “Paste” from the Edit menu, or hold down [Ctrl](Win) or [Cmd](Mac) and press [V].**  
The copied section is pasted in, and the song position is moved to the end of pasted selection.
- 6. Paste again, as many times as you want to repeat the selection.**

## Naming clips

- 1. You can name an individual clip by selecting it and then selecting “Add Labels to Clips” from the Edit menu or context menu.**  
A text field is opened.
- 2. Type in a name for the clip and then press [Return].**

When adding labels to several selected clips in one go, they will all receive generic names according to the clip type (e.g. “untitled note clip”). Double-clicking on a label in a clip opens the text field where you can type in the label text.

## Renaming clips

- **To rename a clip, double-click on the label, type in a new name and press [Return].**

## Removing labels from clips

- **To remove labels from clips, select them and choose “Remove Labels From Clips” from the Edit menu or context menu.**  
Alternatively, double-click on the clip label, press [Backspace] or [Delete] and then press [Return].

## Coloring clips

By default Clips are set to "Use Track Color", and will have the same color as their tracks. You can override this by selecting individual colors from the Clip Color submenu.

- **Select “Clip Color” from the Edit menu or the context menu and then choose a color from the palette on the sub-menu.**  
All selected clips will be colored according to the selected color. If you record new clips on the lane, they will be colored according to the set track color.

# Splitting clips

You can split clips using the Razor Tool in Arrange Mode. To split a single clip, proceed as follows:

**1. Select the Razor Tool and place it where you want to split the clip.**

On the Razor Tool's left edge is a cross-hair which indicates where the split will take place. If activated, the Snap setting is taken into account (see "Snap").

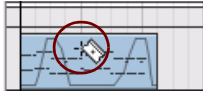

**2. Click with the Razor Tool to split the clip at the cross-hair's position.**

The clip is now split into two separate clips.

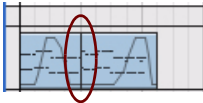

*A vertical line appears where the clip is split.*

**! Recordings and events in a split clip will always remain intact, e.g. notes in a note clip will not be split even if they span over the split point.**

It's also possible to split clips on all tracks in a song:

**1. Place the Razor Tool's cross-hair on the Ruler where you want to split the clips on all tracks and lanes of the song.**

**2. Click in the Ruler to split the clips on all tracks and lanes at the current position.**

Clips on tracks and lanes - including tracks and lanes that might not be visible - on the Arrange Pane will also be split.

You can also cut out a section of one or several clips in one go to:

**1. Place the Razor Tool on the Arrange Pane background close to where you want to split the clips.**

**2. Click and drag with the Razor Tool to select the split section - on one or several lanes.**

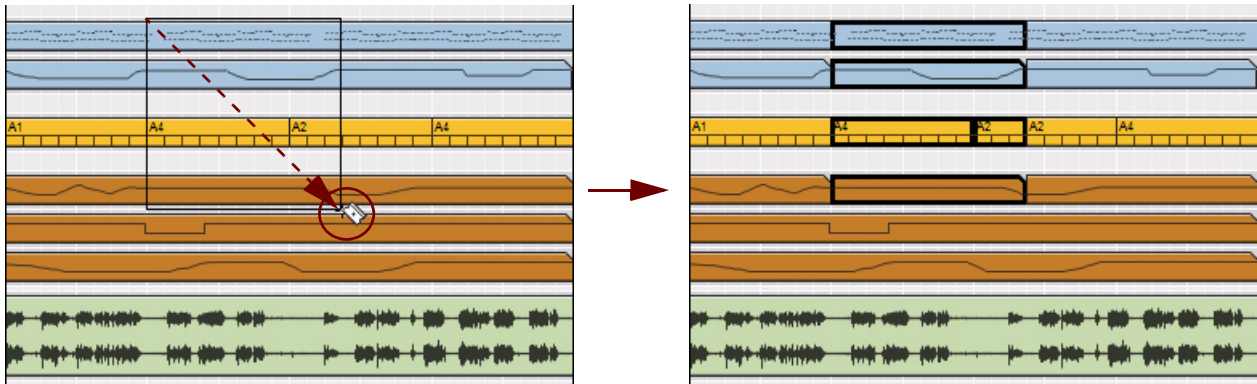

**3. Release the mouse button to split the clips.**

If you want to “cut” out a section of all clips on all tracks in the song, this can be done as follows:

1. **Place the Razor Tool’s cross-hair on the Ruler where you want to split the clips on all tracks of the song.**

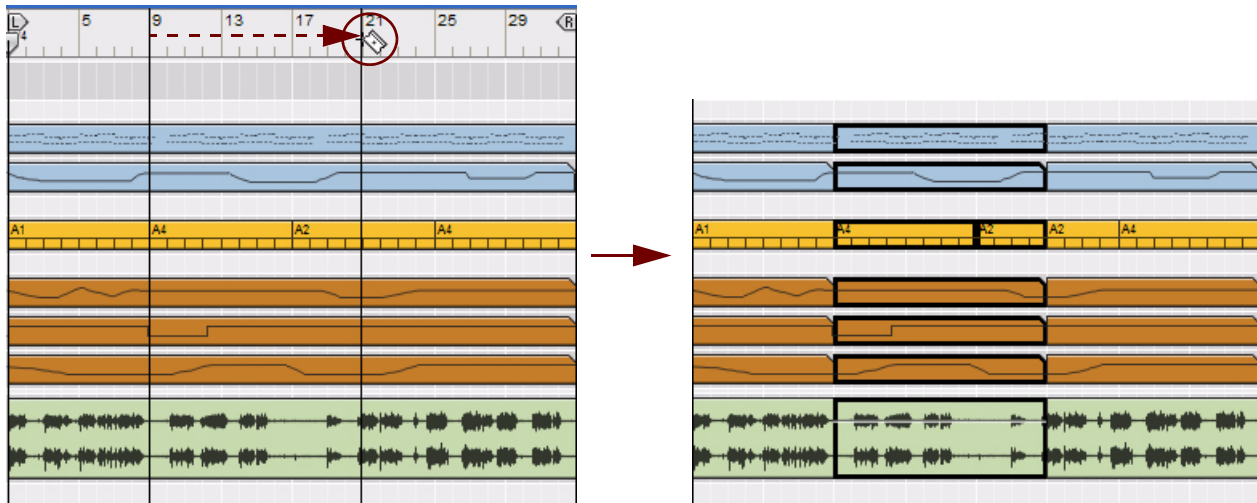

2. **Click and drag the Razor Tool in either direction on the Ruler to make a range selection.**
  3. **Release the mouse button to split the clips on all tracks and lanes in the song.**
- ! **Clips on tracks and lanes that might be scrolled out of view on the Arrange Pane will also be split.**

## Duplicating a part of one or several clips

By using either of the methods described above, it’s also possible to duplicate the “split” section of the clip(s) and then move them to a new destination. Here’s how:

- **With the Razor Tool selected, hold down [Ctrl](Win) or [Cmd](Mac) and drag to create a duplicate of the “cut out” section of the clip(s). Then, use the Selection Tool to move the duplicated clip(s) to a new destination.**  
The original clips will remain uncut, just as they were before the operation.

## Joining clips

Separate clips on the same lane can be joined into one clip. You can also join clips that aren’t directly adjacent on the lane, or clips that overlap each other.

1. **Select the clips you wish to join.**

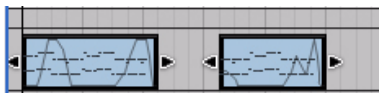

2. **Select “Join Clips” from the Edit menu or from the clip context menu. Alternatively, hold down [Ctrl](Win) or [Cmd](Mac) and press [J].**

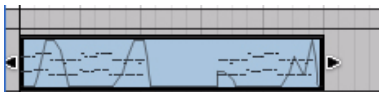

A single clip is created. If there was a gap between the clips before the operation, this area will be empty - the original positions of all events in the original clips will be preserved in the joined clip.

- **Only clips on the same lane can be joined.**  
It’s possible to select several clips on several lanes, but only selected clips on the same lanes will be joined.

- **You can also join selected clips that have other non-selected clips in-between them.**  
The non-selected clips in-between will then overlap and mask the joined clip at their current positions.
- ! **If you join note or parameter automation clips that contain masked events in the area(s) between the clips, the masked events will be permanently deleted! This is to make the resulting clip play back the same as the original clips did before joining.** (See **“Masked events in note and parameter automation clips”**).
- ! **If you join overlapping note or parameter automation clips, the events in the clip which lies on top will replace and permanently delete the events in the overlapped region of the “hidden” clip.**

## About joining audio clips

Joining audio clips basically works in the same way as joining note and parameter automation clips - except when it comes to joining overlapping audio clips. What happens if you join overlapping audio clips is that the clips will be placed on separate Comp Rows - and be automatically comped to a “final” clip. No recording will be deleted. Let’s have a look at the example in the picture below:



*The original audio clip (blue) with an overlapping audio clip (yellow) selected in Arrange Mode.*



*The two audio clips joined into a single audio clip in Arrange Mode.*

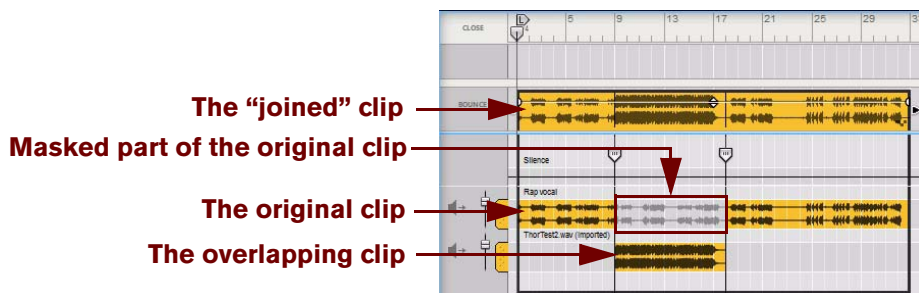

*The “joined” audio clip open in the Comp Editor.*

As you can see, the entire audio recording in the original clip is preserved - only masked where the overlapping clip is located. If you change your mind afterwards, you will still be able to access the entire original recording.

- **If overlapping clips have different Clip Levels, the Comp Row Levels will change to these levels after joining.**  
The Clip Level in the joined clip will be set to -0 dB.
- **If overlapping clips use Fade In and/or Fade Out and the clips overlap in the Fade In/Out area(s), the Fade(s) will be removed after joining.**  
Also, if you join audio clips that aren’t directly adjacent, any Fade Out in the first clip and Fade In in the second clip will be removed.
- **Any Cut Crossfades used in comped audio clips will be preserved after the joining.**

## Muting clips

Clips can be muted as follows:

- **Select the Mute Tool from the Toolbar and click on the clips you want to mute.**

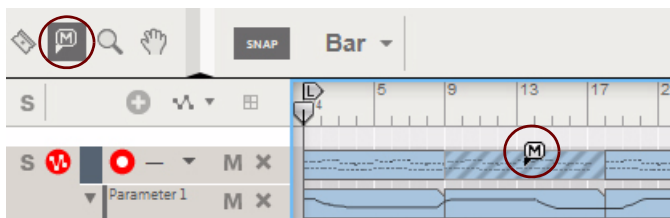

Muted clips are indicated with gray stripes, borders and events:

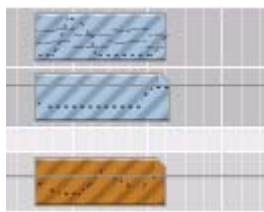

*Muted clips.*

- **Select the clips and then select “Mute Clips” from the Edit menu or from the clip context menu. Alternatively, select the clips and press [M] on the computer keyboard to mute them.**

## Unmuting clips

Muted clips can be unmuted as follows:

- **Click on muted clips with the Mute Tool.**
- **Select muted clips with the Arrow Tool and select “Unmute Clips” from the Edit menu or context menu - or press [M].**
- ! **Muted clips cannot be joined with other clips.**
- ! **Muted note clips will not be included when using the “Merge Note Lanes on Tracks” function described in the “Merging clips on note lanes” section.**

## Merging clips on note lanes

Several note lanes on a track can be merged into a single note lane:

1. **Select the track with the note lanes you wish to merge.**

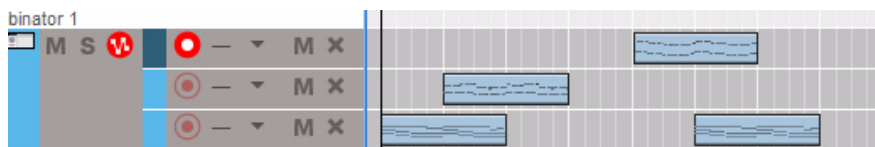

*A selected instrument track with separate note lanes.*

## 2. Select “Merge Note Lanes on Tracks” from the Edit menu or from the context menu.

The clips on all note lanes will be merged on the topmost note lane.



*The same instrument track after merging.*

- If there are time gaps between the clips on the lanes, several clips will be created on the merged note lane.
- Muted note lanes or muted clips on the track will not be included in the merge.
- It's also possible to select several tracks and merge the note lanes on each individual track, all in one go.

## Matching clips using the “Match Values” function

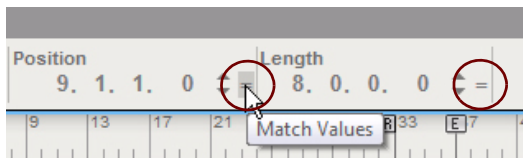

The “Match Value” function in the Inspector can be used for matching the positions or lengths of several selected clips to the position and/or length of the topmost selected clip (or leftmost if the clips are on the same lane).

### Matching clip positions

To match clip positions:

1. Select a couple of clips on the Arrange Pane.
2. Click the “Match Values” button to the right of the Position display to move all selected clips to the start position of the topmost clip - or leftmost clip, if the clips are on the same lane.

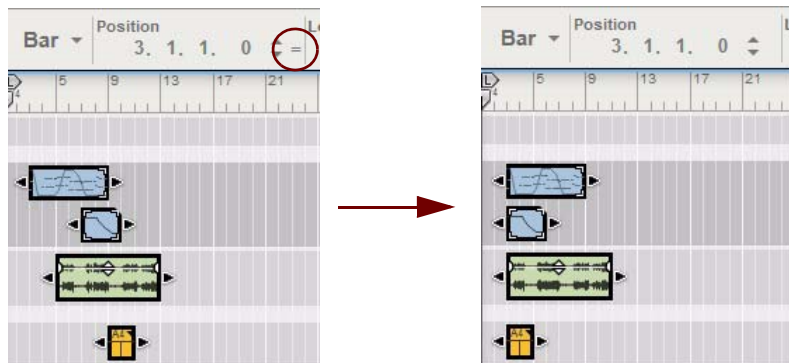

All selected clips are moved to the start position of the topmost selected clip.

- ! **Note:** If you match the position of several clips on the same lane, they will all start at the same position, and thus overlap.

## Matching clip lengths

Another Match Value function in the Inspector can be used to match the lengths of several selected clips to the length of the topmost (or leftmost if on the same lane) selected clip:

1. Select a couple of clips on the Arrange Pane.
2. Click the “Match Values” button to the right of the Length display to resize all selected clips to the length of the topmost clip - or leftmost clip, if the clips are on the same lane.

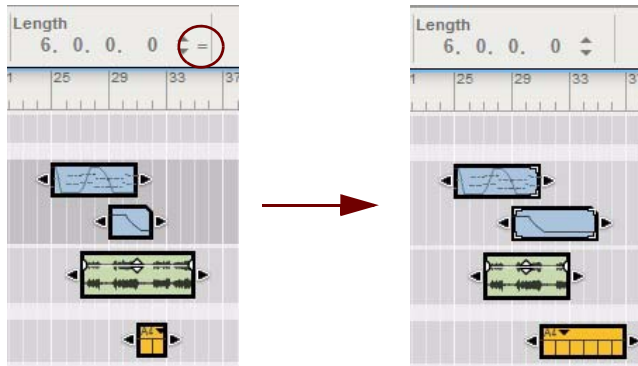

All selected clips are resized to a length of 6 bars - the same as the topmost selected clip.

## Matching audio clip levels, fades and transposition

In addition to Position and Length matching, audio clips can have their Fades, Levels and Transpose values matched:

1. In Arrange Mode, select a couple of audio clips.
2. Click the “Match Values” buttons to the right of the respective displays to match to the values of the topmost clip - or leftmost clip if the clips are on the same lane.

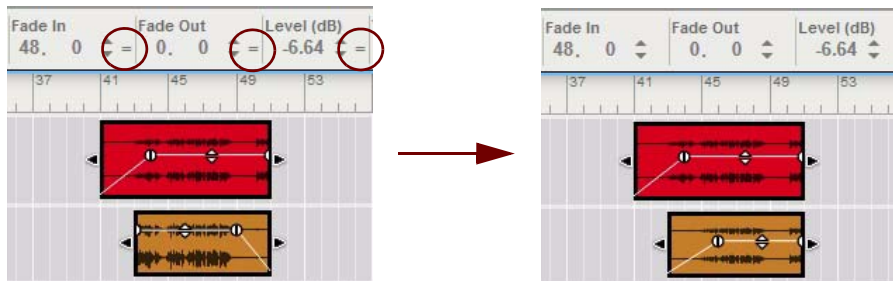

After having clicked the Match Values buttons, all selected audio clips get the same values as the topmost selected audio clip.

## Inserting bars

The “Insert Bars Between Locators” function on the Edit menu, or context menu, can be used for inserting empty bars between the Left and Right Locators. All clips that intersect the locator positions on all tracks after the Left Locator are split and moved to the Right Locator to make room for the inserted bars.

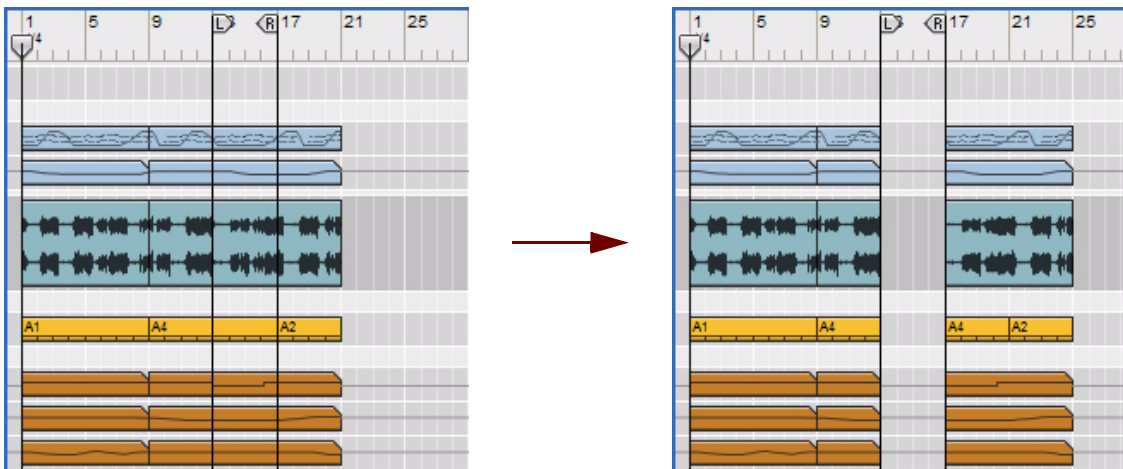

*Different tracks with lanes before and after insertion of 4 extra bars between bars 13-17.*

## Removing bars

The “Remove Bars Between Locators” function on the Edit menu, or context menu, removes all events between the Left and Right Locators. All clips that intersect the locator positions will be cut (when necessary), and the cut section (between the locators) will be removed. All clips that originally were located to the right of the Right Locator will then be moved to the Left Locator, closing the gap.

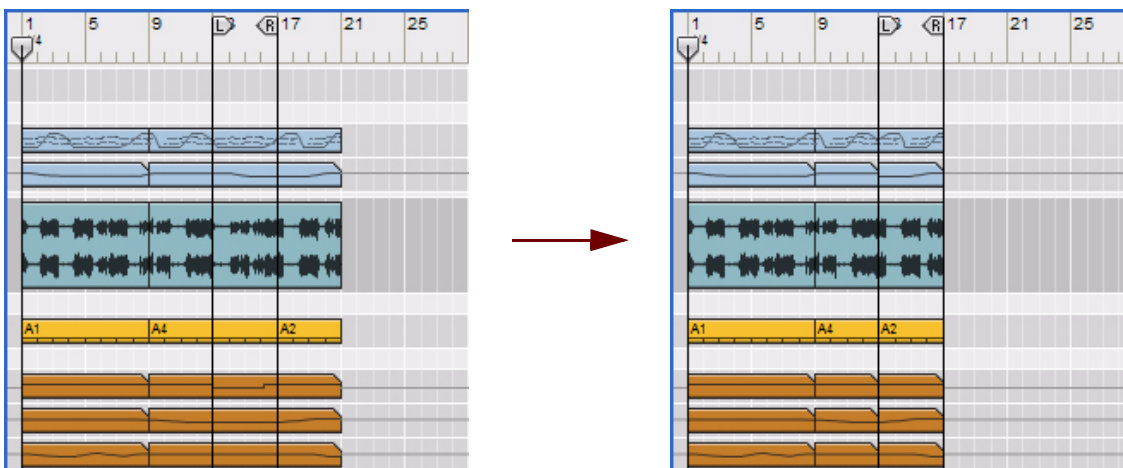

*Different tracks with lanes before and after removal of 4 bars starting at bar 13.*

**! Any removed note and parameter automation events between the Left and Right Locators will be deleted!**



## About removing bars that contain audio recordings

As opposed to note and parameter automation events, audio recordings in removed bars will not be deleted. Instead, they will be placed on a Comp Row and masked. If we open the second audio clip in the previous example in Edit Mode, we can see that the audio recording in the removed bars has been moved forward and masked:

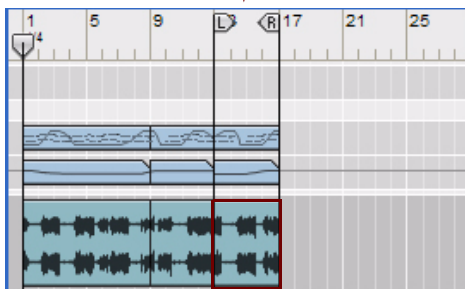
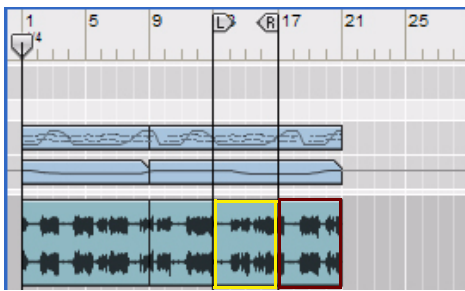

The audio clip in Song View before and after removal of four bars (yellow frame) between the locators.

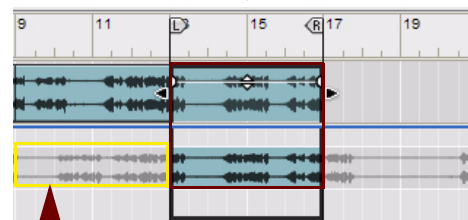
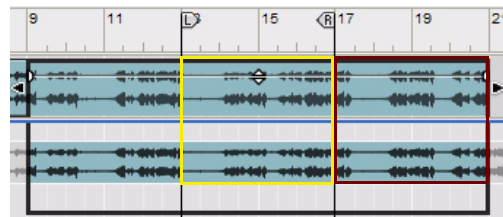

The audio clip in the Comp Editor after removal of four bars.

**“Removed” recording moved forward on the Comp Row and masked**



# **Chapter 8**

## **Audio Editing in the Sequencer**

# About this chapter

This chapter describes how to edit audio clips after you have recorded them in the sequencer. General sequencer functions, recording, note and automation editing, and arranging in the sequencer are described in detail in the chapters “Sequencer Functions”, “Recording in the Sequencer”, “Note and Automation Editing” and “Arranging in the Sequencer”.

## Clip Modes and Editing

After you have recorded your audio clips, you might want to adjust levels, trim starts and ends, add fades etc. If you have recorded several takes in your audio clips, or several cycles in Loop Mode, you can also cut out segments of the various takes and compile (comp) them into a final “perfect” audio clip.

You can also quantize audio clips, manually change the timing of individual notes or beats in the clips and even export audio clips as REX files.

### Inline editing vs. the Comp Editor (Edit Mode)

There are two main ways you can edit your audio clips:

- **Inline, in the Arrange View.**  
Inline editing can be made on Single Take clips (see “Clip Modes” below). Single Take clips can be opened for editing in the Arrange View, similar to when editing parameter automation clips. Inline editing allows you to adjust the positions (timing) of the automatically detected and distributed transient slice markers that appear in the audio clip. The timing can be adjusted by moving and stretching (warping) the audio slices.
- **In the Comp Editor (Edit Mode) to create compiled clips out of multiple recordings in the clip.**  
The Comp Editor is where you can cut out segments of several Takes (recordings) and compile into a final clip. Here you can also insert silence segments to e.g. remove noise from silent parts in your audio clips.

## Clip Modes

An audio clip can be either in Single Take Mode or Comp Mode:

- **A clip in Single Take Mode is set to play back only a single Take (Comp Row) throughout the audio clip.**  
If you have recorded only once in an audio clip, or recorded several complete Takes, the clip is automatically set to Single Take Mode.
- **A Single Take clip which contains only one single Comp Row does not have any special visual indication:**



A Single Take clip could also contain several Comp Rows, where one Comp Row has been manually selected for playback.

- **Single Take clips that contain more than one Comp Row are distinguished by two parallel lines in the lower right corner:**



You can create a Comp clip out of a Single Take clip by opening it in the Comp Editor/Edit Mode and adding Cuts, see “Adding Cuts”.

- **A Comp Mode clip is built up by segments from several recordings on multiple Comp Rows in the clip.**  
If you have recorded (or imported) several takes in the same audio clip - or recorded several loops in Loop Mode - and then compiled segments of the various Comp Rows in the Comp Editor, the clip is in Comp Mode. You can manually turn a Comp clip into a Single Take clip by clicking the “Bounce” button in the Comp Editor (see [“Turning Comp clips into Single Take clips”](#)) - or by opening the clip and manually selecting a single Comp Row for playback by clicking the desired Single Take Mode button (see [“Single Take Mode button”](#)).
- **Comp Mode Clips are distinguished by a couple of dots in the lower right corner:**



The dots indicate that there are compiled Comp Rows in the clip.

## Opening audio clips for editing

In the Arrange View, audio recordings are displayed as one or two (mono or stereo) waves in the audio clips. The selected audio clips in the pictures below contain mono recordings.

### Opening a Single Take clip

If the audio clip only has one single Comp Row, or several Comp Rows but only plays back one of these, it means it's in Single Take Mode (see [“Clip Modes”](#)). Open the clip as follows:

- **Open a Single Take clip by double-clicking it, or by selecting it and pressing [Return].**

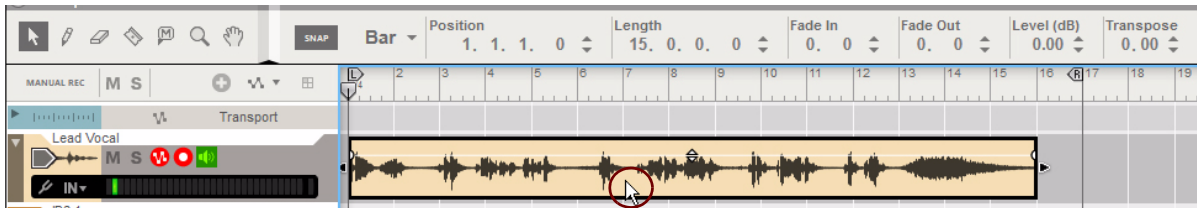

*Double-click a Single Take audio clip in the Arrange View...*

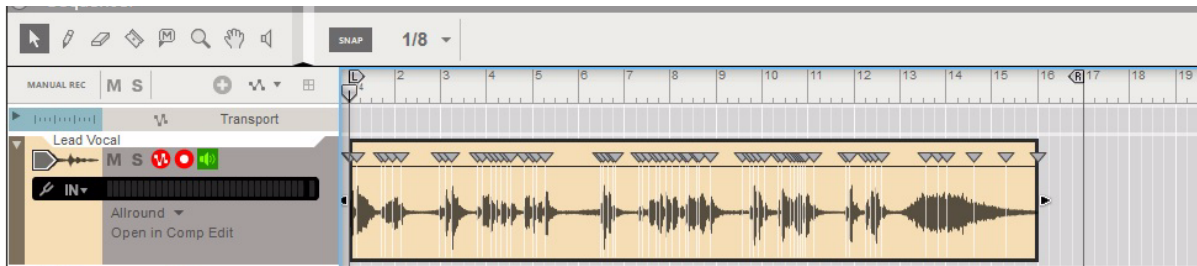

*...to open it for inline editing in the Arrange View.*

The Single Take clip opens inline in the Arrange View, i.e. the sequencer does not enter Edit Mode. This behavior is similar to when you open automation clips in the sequencer.

When the audio clip is open inline you can stretch, move and quantize audio slices etc., see [“Editing audio inline”](#).

- **To open another Single Take clip on the same track inline (and thus close the currently open clip), double-click the other clip.**

It is also possible to open a Single Take clip in the Comp Editor:

- **Select the Single Take clip and its track, and hold down [Ctrl](Win) or [Cmd](Mac) and press [E].**
- **Click the “Open in Comp Edit” button in the Track List when the Single Take clip is open inline.**

## Closing a Single Take clip

- To close a Single Take clip which is open inline, press [Esc] or [Return].  
Alternatively, click outside the open clip on the Arrange Pane, but not on the same track.

## Opening a Comp clip

If the audio clip is in Comp Mode (see “Clip Modes”), you can open the clip as follows:

- Open a Comp clip by double-clicking it, or by selecting it and pressing [Return].  
The sequencer automatically opens the clip in the Comp Editor (Edit Mode).

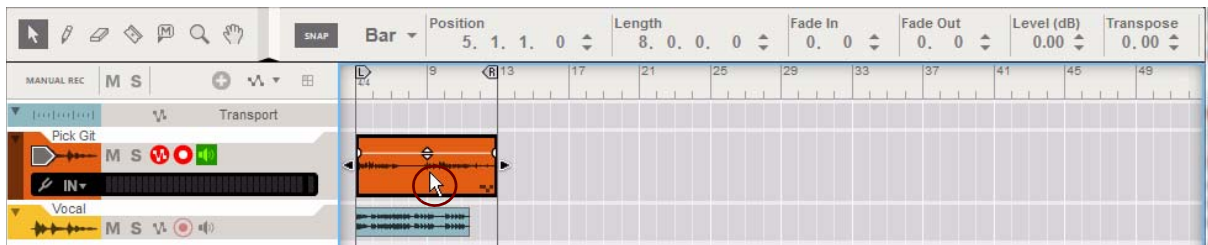

*Double-click a Comp clip in the Arrange View...*

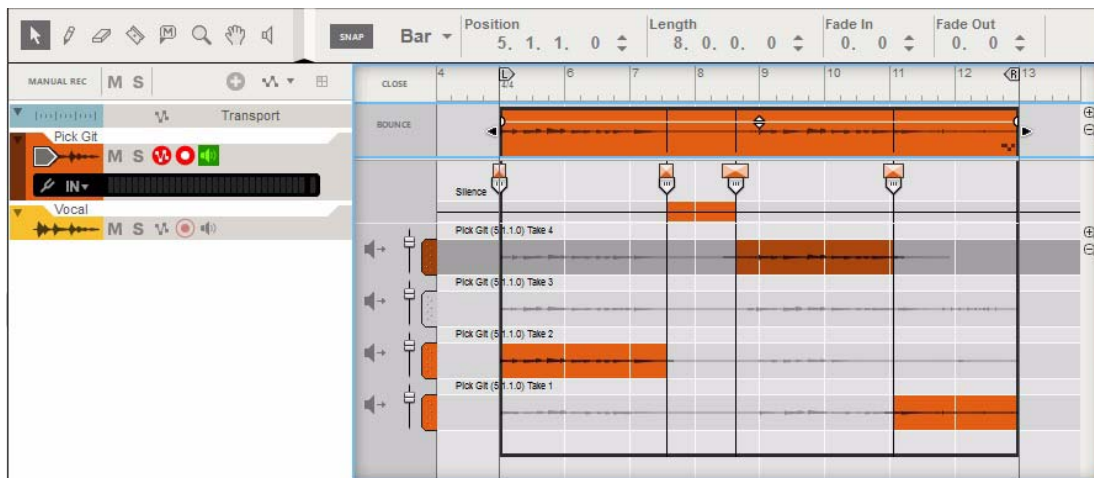

*...to open it for editing in the Comp Editor.*

- To exit and return to the Arrange View, either press [Esc], [Return] or click the “Close” button in the Comp Editor.

## Editing audio inline

### Preparing audio clips for inline editing

Inline editing, including stretching of audio slices, can only be performed on Single Take clips. If you have Comp clips that you want to edit inline, you first have to convert the Comp clips to Single Take clips, see “Turning Comp clips into Single Take clips”.

- ! If you plan to comp the audio in your clips in the Comp Editor, always do that before you start to work with slice stretching etc. inline. It will save you a lot of work if all the comping has been done beforehand!

- ! For the audio stretching to work, make sure the **Enable Stretch** function is active on the clips you are working with, see **“Enable/Disable Stretch (Audio Clips)”**.
- ! To get the best sound quality when you are stretching and quantizing audio it’s important that you have selected the correct **Stretch Type** for the audio track, see **“Selecting Stretch and Transpose Type”**.

## Audio clip elements inline

When a Single Take clip is open for editing inline in the Arrange View, it could look like this:

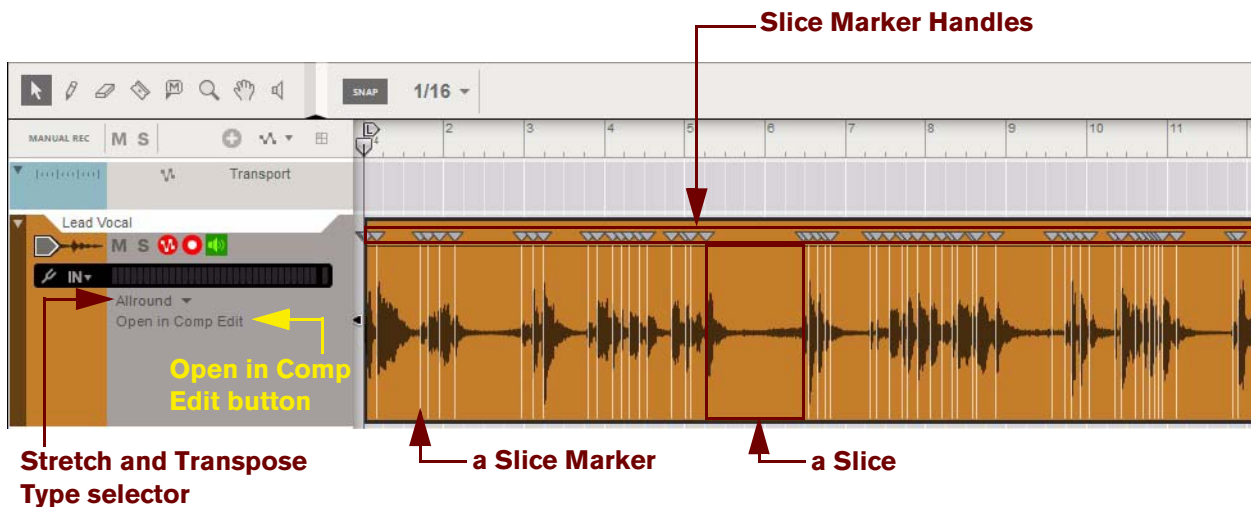

*A Single Take clip open inline.*

- You might have to zoom in quite a bit on the clip to get a good view of the Slices, see **“Zooming in the Sequencer”**.
- **Slice Markers with handles**  
When a Single Take audio clip is opened inline, Reason automatically detects the transients in the sound and marks these with vertical white lines - Slice Markers. By moving Slice Markers left or right you stretch (warp) the audio between the nearest Slice Markers on either side, i.e. you change the timing without affecting the pitch. You can manually add and remove Slice Markers. It is also possible to “decouple” and move the Slice Markers without stretching the audio.
- **Slices**  
Slices are the areas between two adjacent Slice Markers. Each slice represents a part of the audio in the clip.
- **Stretch and Transpose Type selector**  
Here is where you can select the most suitable Stretch and Transpose Type for the audio on the track. See **“Selecting Stretch and Transpose Type”** for more details.
- **Open in Comp Edit button**  
Click this to open Single Take clips for editing in the Comp Editor.

## Inline audio editing tools

When editing audio inline, some of the Toolbar tools have different functionality than when editing note and automation clips. There are also some additional tools that are unique to inline editing of audio.

## Speaker Tool

It's possible to audition individual Slices without needing to start playback of the sequencer:

- **Select the Speaker Tool in the Toolbar and click in the waveform area on the Slice you want to audition.**

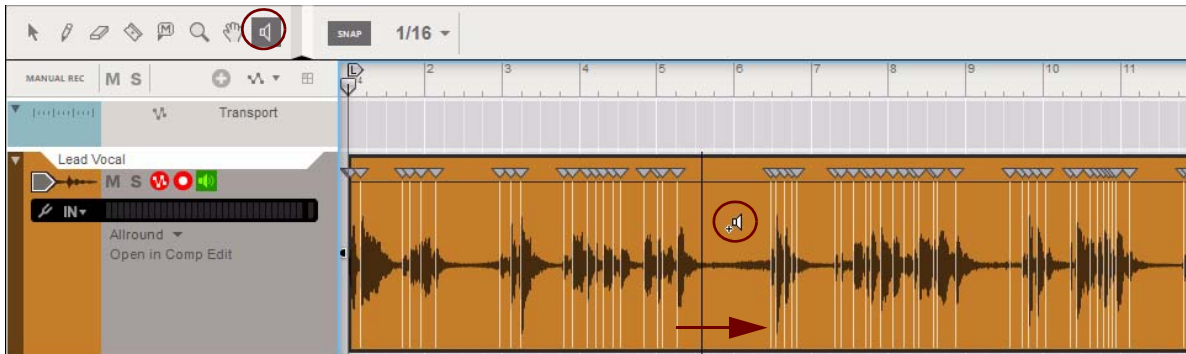

The Slice is played back once in its entirety, from the start Slice Marker to the end Slice Marker of the desired Slice, each time you click.

- **With the Selection Tool (Arrow) selected, pressing [Alt](Win) or [Cmd](Mac) will momentarily switch to the Speaker Tool.**
- ! **Note that auditioning Slices will play back the unprocessed sound - bypassing the Main Mixer settings.**

## Selecting Slices and Slice Markers

A Slice is the portion of audio between two adjacent Slice Markers. A Slice Marker indicates the beginning of a Slice - and consequently the end of the preceding Slice (if it's not the first Slice in the clip).

- **To select a Slice Marker, click the Slice Marker or its handle:**

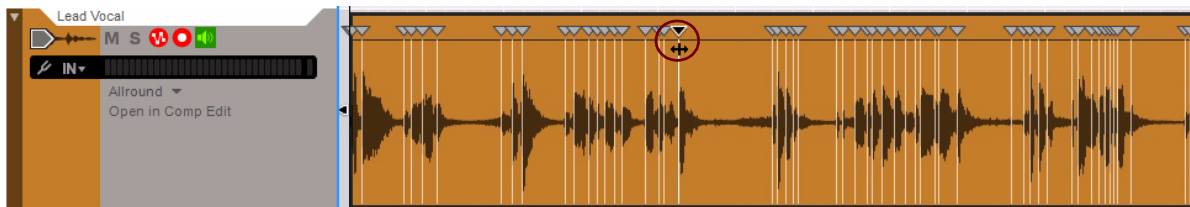

As you hover over a Slice Marker or a Slice Marker Handle, the arrow switches to a double-arrow. A selected Slice Marker is indicated by a black Slice Marker Handle.

- **To select several individual Slice Markers, hold down [Ctrl](Win)/[Shift](Mac) and click the desired Slice Markers or their handles.**

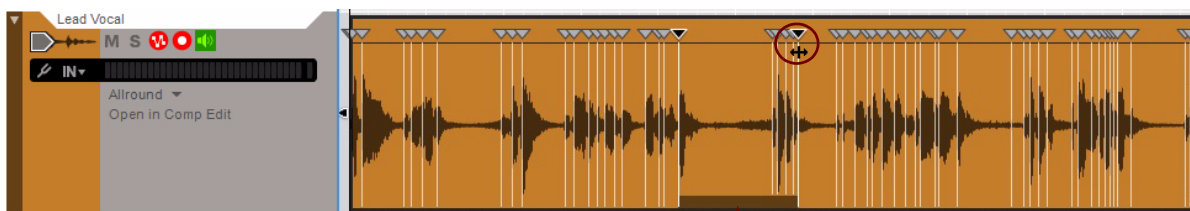

← a Slice Group Handle

If more than one Slice Marker has been selected, a Slice Group Handle appears below the waveform. You could then click and drag the Slice Group Handle sideways to move all selected Slice Markers as a group, see ["Moving several Slice Markers"](#).



- To select a range of Slice Markers, draw a rectangle with the Selection Tool (Arrow), in the Slice Marker Handles area or in the waveform area, that touches the desired Slice Markers:

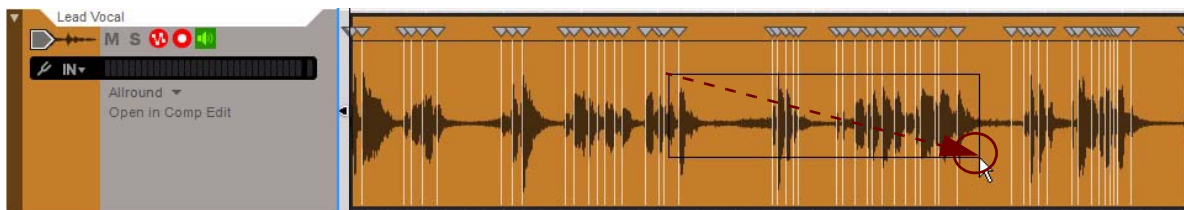

*Draw a rectangle over the desired Slice Markers to select a complete range.*

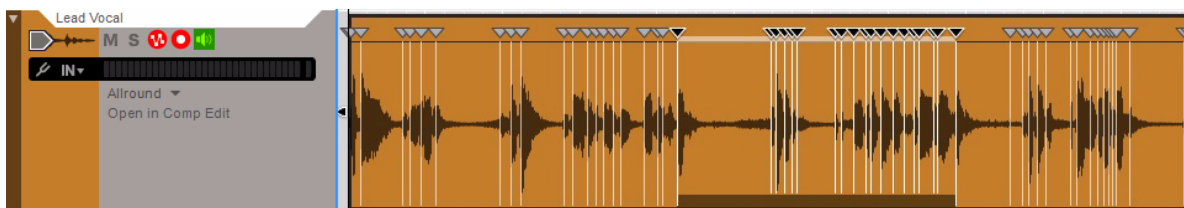

*As you release the mouse button all touched Slice Markers are selected.*

The range of Slice Markers can then be moved as a group by clicking and dragging the Slice Group Handle sideways. You can also stretch the range in an “accordion style” fashion by clicking and dragging any of the selected Slice Marker Handles in the range, see [“Stretching a range of Slices”](#).

- Under Windows it’s also possible to select a range of Slice Markers by clicking a Slice Marker and then holding down [Shift] and clicking the first or last Slice Marker in the desired range.
- You can expand a Slice/Slice Marker selection range by holding [Shift] and pressing the left/right arrow keys.
- To select all Slices/Slice Markers in the clip, select “Select All” from the clip’s context menu or from the Edit Menu.

Now, you can move all Slice Markers as a group by dragging the Slice Group Handle sideways (see [“Moving several Slice Markers”](#)), or stretch the entire range of Slices (see [“Stretching a range of Slices”](#)).

## Adding Slice Markers

When you open a clip, there will be a Slice Marker at each transient, plus one at the start and one at the end of the clip. If you are not satisfied with Reason’s automatic Slice Marker assignments you can add Slice Markers manually:

! You might want to turn off Snap to be able to position the Slice Markers more precisely (see [“Snap”](#)).

1. Open the Single Take clip for editing inline.
2. Select the Pencil Tool from the Toolbar.
3. Click in the open clip to add new Slice Markers.

If you are not satisfied with the position of the Slice Marker, you can reposition it afterwards, see [“Repositioning Slice Markers”](#).

! You cannot add Slice Markers before the first Slice Marker or after the end Slice Marker in the clip.

## Deleting Slice Markers

To delete Slice Markers, proceed as follows:

1. Select the desired Slice Marker(s) as described in [“Selecting Slices and Slice Markers”](#).
2. Press [Delete] or [Backspace] to delete the marked Slice Makers.

This deletes the Slice Markers but not the audio that’s in the clip.

- ! If you delete Slice Markers that were previously moved, the stretched audio will revert to the original timing.
- ! You cannot delete the first Slice Marker or the end Slice Marker in the clip.

## Repositioning Slice Markers

To reposition a Slice Marker without stretching the audio, proceed as follows:

- ! You might want to turn off Snap to be able to position the Slice Marker more precisely (see “Snap”).
1. Place the Selection Tool (Arrow) on a Slice Marker or Slice Marker Handle.  
The arrow switches to a double-arrow symbol.
  2. Hold down [Ctrl](Win) or [Option](Mac) and click and move the Slice Marker sideways.
- ! You cannot move Slice Markers past their closest adjacent Slice Markers.

## Moving/stretching Slices

Stretching can be used for adjusting the timing of the transients in the audio clip. You can also use stretching to create special effects such as increasing or decreasing the lengths of the Slices. Stretching can be applied on single Slices as well as on a selection of Slices.

- ! To get the best sound quality when you are stretching audio it’s important that you have selected the correct Stretch and Transpose Type for the audio track, see “Selecting Stretch and Transpose Type”.
- ! You might want to turn off Snap to be able to position the Slice Marker more precisely (see “Snap”).
- ! You cannot move Slice Markers past their closest adjacent Slice Markers.

## Preview vs. High Quality Stretching

Reason features very sophisticated audio stretch and transpose algorithms for pristine results. Reason always performs audio stretching in two parallel steps:

- A real-time “preview” stretch so that you can instantly hear the result of your changes.
  - A high quality stretch “in the background” to further improve the sonic results.
- As soon as high quality stretch is in progress, the “Calc” indicator on the Transport Panel shows a progress meter:



*The CALC progress meter appears when Reason performs high quality stretching of audio.*

Since the high quality stretch is performed in the background, you can still continue to work with your song without any interruption. When the high quality stretch data has been calculated, the Calc indicator goes out and the high quality audio data will be heard on playback.

## Moving a Slice Marker

- To adjust the timing of a single note or beat, just click and drag its Slice Marker to the desired position.  
If Snap is on, the Slice Marker will snap to the grid as set with the Snap value.

When you move a Slice Marker, the slices on either side of it will be stretched accordingly.

## Moving several Slice Markers

If you need to adjust the timing of several notes or beats (e.g. move all snare hits a little later in the beat), proceed as follows:

1. **Select the desired Slice Markers as described in “Selecting Slices and Slice Markers”.**

2. **Click and drag the Slice Group Handle to move all selected Slice Markers.**

As you hover over the Slice Group Handle, the arrow switches to a double-arrow

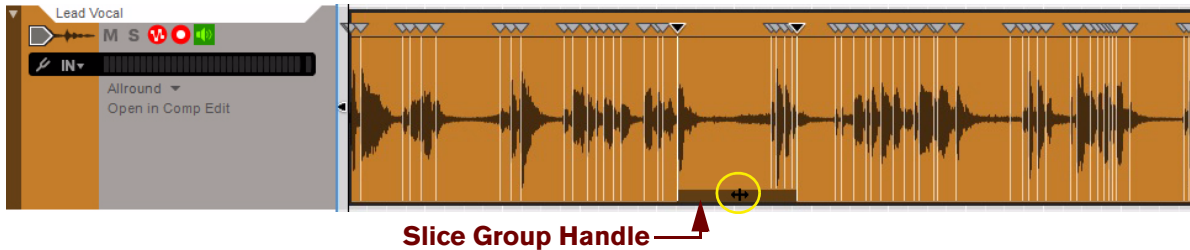

All selected Slice Markers will be moved as a group. The Slices between the selected Slice Markers and their closest unselected Slice Markers will be stretched.

• **It's also possible to move a range of Slices by selecting a range of Slice Markers as described in “Selecting Slices and Slice Markers” and then dragging the Slice Group Handle sideways.**

This is useful if you want to move a whole phrase (e.g. a vocal phrase) later or earlier in the clip.

! **You cannot move the selection past any unselected Slice Markers.**

## Stretching a range of Slices

It is also possible to stretch a range of Slices, proportionally, in an “accordion style” fashion:

1. **Select the desired range of Slice Markers as described in “Selecting Slices and Slice Markers”.**

The range is indicated by a light gray Stretch Range Marker above the waveform.

→ **If you drag the start or end Slice Marker in the range, the whole range will be stretched as if it were a single slice:**

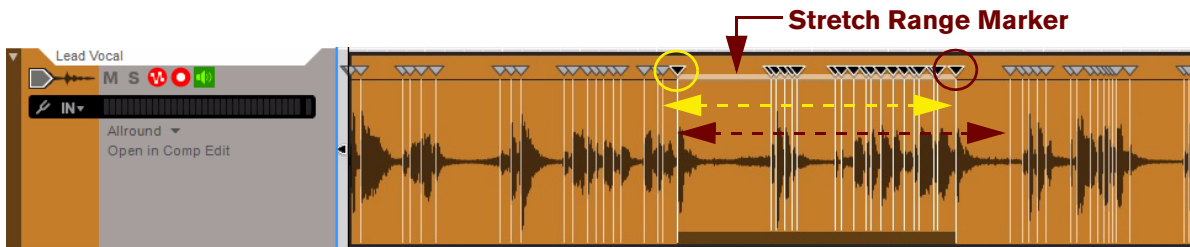

→ **If you drag a Slice Marker within the selected range, all selected Slices will be stretched proportionally against the start and end Slice Markers of the selected range:**

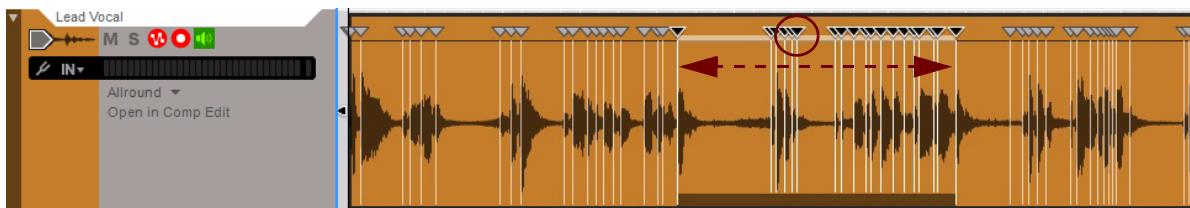

## Nudging Slices

You can nudge the Slice Marker(s) by using the following standard key commands:

- Hold down [Ctrl](Win) or [Cmd](Mac) and press the left/right arrow keys to nudge in Snap value steps.
- Hold down [Ctrl]+[Shift](Win) or [Cmd]+[Shift](Mac) to nudge in Beat steps.
- Hold down [Ctrl]+[Alt](Win) or [Cmd]+[Option](Mac) to nudge in Ticks steps.

## Quantizing audio

Audio quantizing can be made in the Quantize section on the Transport Panel, in the Tool Window or from the context menu or Edit menu.

- ! Audio can only be quantized after recording, not during recording.
- ! Quantize requires that the clips have Stretch enabled (see “Enable/Disable Stretch (Audio Clips)”).
- ! To get the best sound quality when you are quantizing audio it’s important that you have selected the correct Stretch Type for the audio track, see “Selecting Stretch and Transpose Type”.
- ! The difference between quantizing audio and MIDI notes is that several Slice Markers cannot be quantized to the same position. Instead, only the Slice Markers closest to the quantization grid will be moved - the remaining Slice Markers will be left unaffected.

It’s possible to use the quantize audio function in the following ways:

### Quantizing selected Slice Marker(s) in Single Take clips open inline

Quantizing Slice Markers has the same effect as moving the Slice Markers to a quantization grid:

1. Select the Slice Markers you want to quantize:

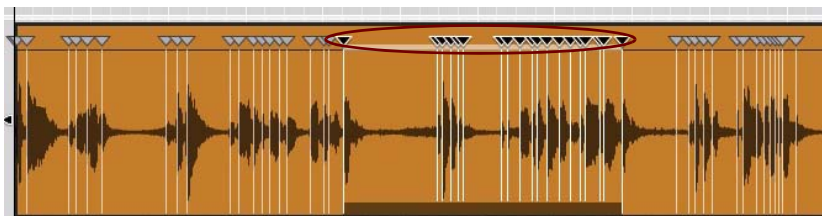

A range of Slice Markers selected for quantization.

2. Select Quantize Value (and Amount and/or Random values) in the Tool Window and click Apply:

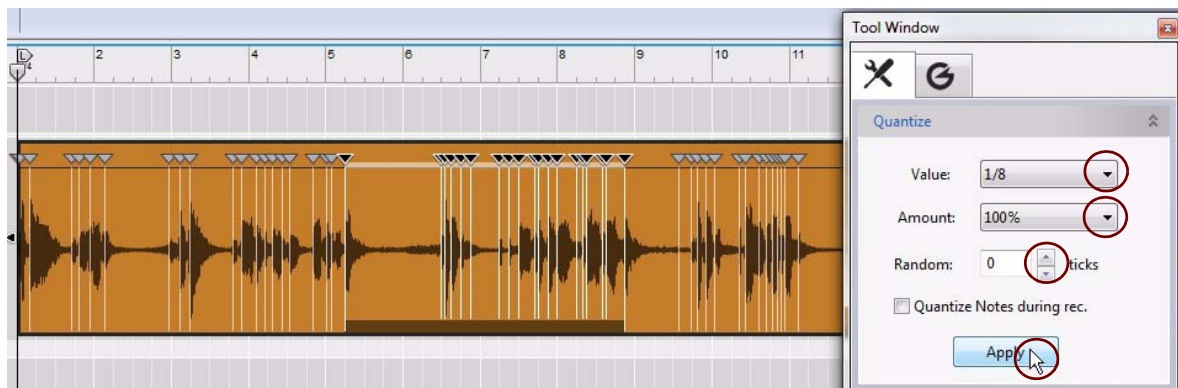

The selected Slice Markers that are closest to the quantization grid are automatically moved to the quantization grid.

- Note that you can quantize to “Shuffle” in the Value list - this will use the Global Shuffle setting made in the ReGroove Mixer, see “Global Shuffle”.

→ **Alternatively, select Quantize Value and click the Quantize button on the Transport Panel.**

This alternative is very handy if you only want to quantize to a set quantization value, and don't need the extra options featured in the Tool Window.

## Quantizing one or several selected Single Take audio clips in the Arrange View

This will quantize all Slice Markers that are closest to the quantization grid in the selected clip(s).

## Split at Slices

The Split at Slices function allows you to create separate audio clips out of a Single Take clip. Splitting can be useful if you, for example, want to reverse parts of the original clip or if you want to export single or multiple Slices as separate samples for use in any of Reason's sampler devices. The split point(s) will be located at the selected Slice Markers in the clip.

The following example shows how the "Split at Slices" function can be used:

**1. Select the split points for the new clips by selecting the desired Slice Markers in the open Single Take clip:**

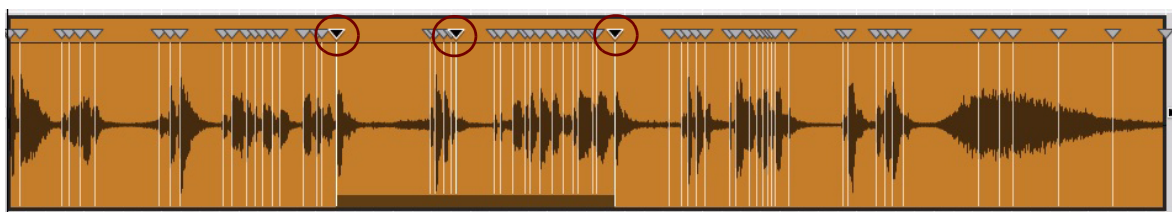

*The selected Slice Markers define the split points for the new clips.*

**2. Select "Split at Slices" from the context menu or Edit menu.**

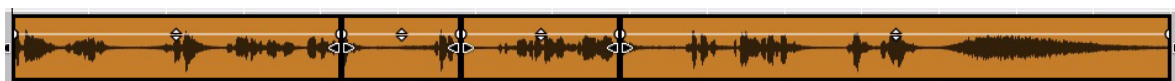

*The original Single Take clip is now split into four separate audio clips and the clips are automatically closed.*

If you like, you can now select the desired clip(s) and move, reverse (see "Reversing Clips") or choose to bounce the clip(s) to samples (see "Bounce Clip(s) to New Sample(s)").

## Bounce Clip to REX Loop

A great feature with Single Take clips is that you can bounce them to REX Loops. You could then load your bounced REX file for further processing in a Dr Octo Rex device, for example! Here is how:

**1. Open a Single Take clip inline.**

**2. Make sure the Slice Markers are located exactly where you want them in the clip.**

This is where the slices in the REX Loop will appear after bouncing.

→ **You might have to remove some Slice Markers in the clip to reduce the number of slices in the final REX Loop, see "Deleting Slice Markers".**

**3. Adjust the audio clip length to the closest full Beat.**

This way you make sure that the REX Loop will sound the same as the original audio clip. If the clip is not adjusted to a full Beat, Reason will automatically expand the clip end to the closest full Beat during the bounce operation.

**4. Select “Bounce > Bounce Clip to REX Loop” from the context menu or Edit menu.**

The bounced REX file ends up in the “All Self-contained Samples” folder in the Song Samples location in the Browser, and is named after the original clip name:

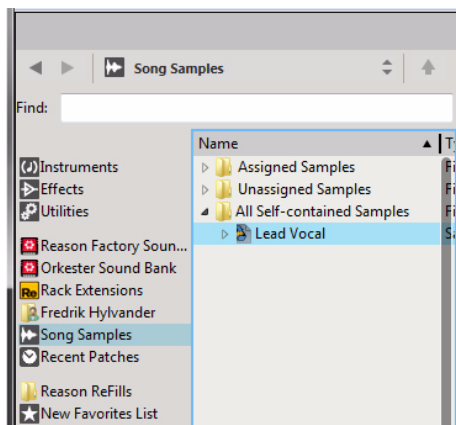

**5. To load the bounced REX file in a new Dr Octo Rex device, either double click the REX file or select the REX file and click the “Create” button at the bottom of the Browser.**

This is a shortcut for creating a Dr Octo Rex device and loading the selected REX Loop in Slot 1 of the Dr Octo Rex device in one go.

➤ Refer to the **“Dr. Octo Rex Loop Player”** chapter for information on how to work with REX Loops in the Dr Octo Rex device.

! If you want to load your REX Loop in another sampler device, you first have to un-self-contain the REX file, see **“Un-self-containing” a Song**. Then, create the sampler device and load the un-self-contained REX file from disk.

## About exporting bounced REX Loops to disk

You can also export your bounced REX Loops to disk if you like:

- 1. Select the REX Loop in the Song Samples location in the Browser and select Export Sample(s) from the context menu or Edit menu.**
- 2. Choose a location for the REX Loop (and change the file name, if desired).**
- 3. Click Save.**

The REX Loop is exported and saved in .rx2 format.

## Revert Slices

If you get lost in the inline Slice editing, there is a handy command for reverting back to the clip the way it was before you started editing the Slice Markers:

- 1. Open the Single Take clip inline.**
- 2. Select “Revert Slices” from the context menu or Edit menu.**

This will revert all slice edits and the clip will play back with its original timing. Any manually removed Slice Markers will appear again, and any manually added Slice Markers will be removed.

# Editing audio in the Comp Editor

In this section we will describe audio editing procedures that are common for Single Take clips and Comp clips when edited in the Comp Editor. Comp clip specific procedures are described in “Comping audio”.

## Audio clip elements in the Comp Editor

When an audio clip is open for editing in the Comp Editor, its contents are shown on the Edit Pane below the Clip Overview area. An open audio clip can have one or several Comp Rows on which the audio recordings reside. The number of Comp Rows depends on how you recorded your audio clip. If you only recorded once in the clip, there will only be one single Comp Row. If you have recorded several times in the same clip, or several cycles in Loop Mode, there will be one Comp Row for each take, or cycle.

There are vertical zoom controls for resizing the Clip Overview area and the Comp Row area. You can also scroll in the Comp Row area by using the scroll bars on the right hand side of the Edit Pane.

## Single Take clips in the Comp Editor

For Single Take clips, only the recording on the selected Comp Row is played back. If there is only one single Take (Comp Row) in the clip, this will play back by default. This is how an open Single Take clip with only one recording on one Comp Row could look like when opened in the Comp Editor:

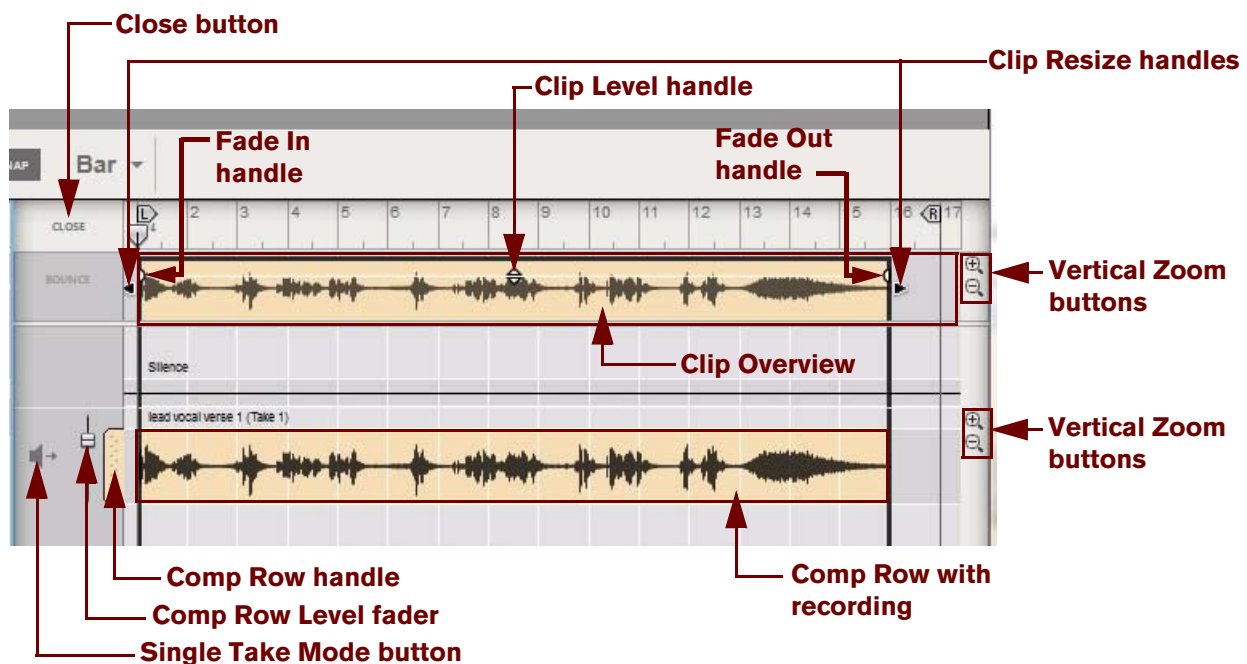

*A Single Take clip open in the Comp Editor.*

- **Clip Overview**

The Clip Overview area at the top shows the clips on the selected audio track. In the Clip Overview area, selected audio clips are displayed in the same fashion as in the Arrange View, i.e. with Clip Resize handles, Level handle and Fade handles. You can select one or several audio clips in the Clip Overview and perform clip-based editing (e.g. moving and resizing) - just like in the Arrange View.

- **Clip Resize handles**

By clicking and dragging either of the handles, you can change the position and length of the clip.

- **Fade In and Fade Out handles**  
Click and drag these handles horizontally to introduce a fade in and/or fade out of the audio in the clip. The fading is non-destructive and can be changed at any time. If Snap is activated (see “Snap”), the set (Arrange Mode) Snap value is taken into account when moving the Fade Handles.
- **Close button**  
Click this button to close the audio clip and exit to the Arrange View.
- **Clip Level handle**  
Click and drag this handle vertically to adjust the audio level of the recordings in the clip. The level adjustment is non-destructive and can be changed at any time.
- **Comp Row**  
Depending on how you recorded the audio clip, there can be one or several Comp Rows, containing one audio recording each. Comp Rows can be described as “virtual tracks” in the sense that you can have many parallel Comp Rows in an audio clip but only play back from one Comp Row at a time (see “Creating a comped audio clip”). In Single Take clips, only the audio recording on the currently selected Comp Row will play back.
- **Comp Row handle**  
If there are several Comp Rows in the audio clip, it's possible to rearrange the order of the Comp Rows by clicking and dragging the Comp Row handles vertically.
- **Comp Row Level fader**  
Use the Comp Row Level fader to adjust the volume of the recording on the corresponding Comp Row. This is especially useful in Comp Mode, when you want to trim and balance the levels of the recordings on several Comp Rows.
- **Single Take Mode button**  
Click this to manually select the desired Comp Row for playback - and thus set the clip to Single Take Mode.
- ! **If the clip only has one single Comp Row, this is automatically selected “in the background” by default - i.e. its Single Take Mode button is not depressed.**



## Comp clips in the Comp Editor

A Comp clip consists of several Comp Rows, with one recording on each Comp Row. If you have recorded several takes in an audio clip and want to cut out sections of the various takes and comp into a final clip, this can be done in the Comp Editor (see “Creating a comped audio clip”). This is how an already comped audio clip could look like in the Comp Editor:

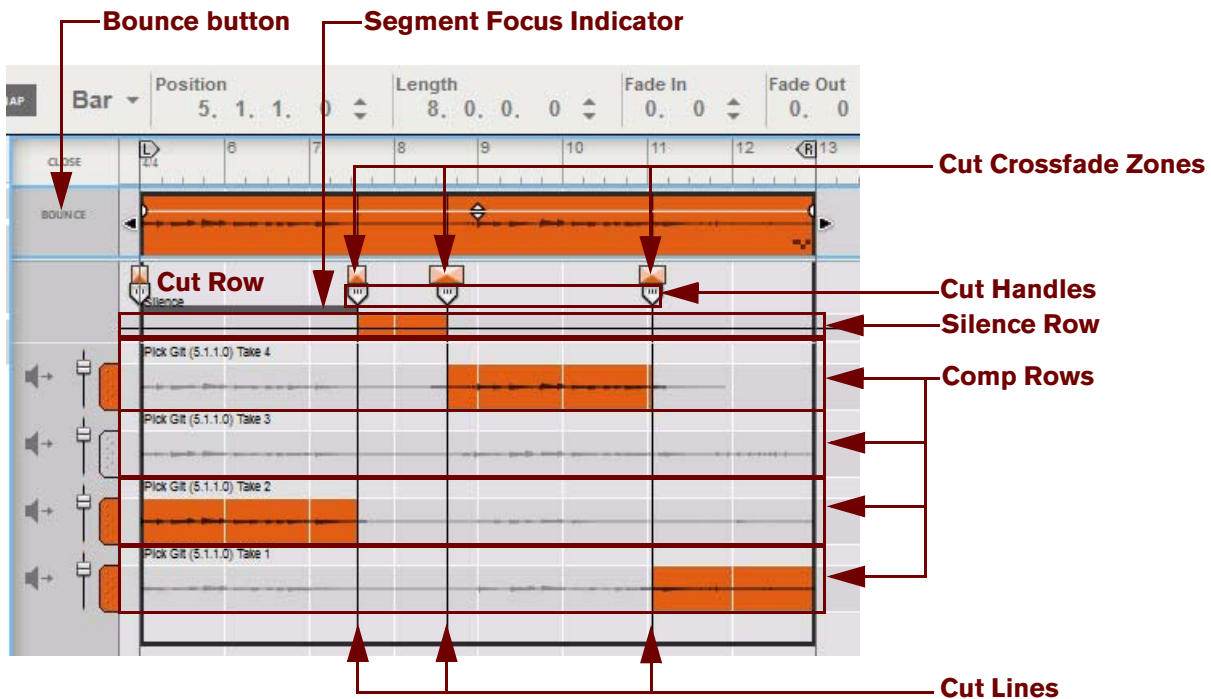

*A Comp clip open in the Comp Editor.*

From the top down in the preceding picture, the Edit Pane contains the following elements:

- **Bounce button**  
Clicking this button will bounce the recordings of the comped clip to a new recording, automatically select the bounced recording's Comp Row - and thus set the clip to Single Take Mode. Then, you can open the Single Take clip inline and work with slices, audio quantizing etc. Clicking this button is usually the last thing you do after you have comped your clip.
- **Cut Row**  
The area between the Clip Overview and the topmost Comp Row is called the Cut Row. This is where the Cut Handles are placed.
- **Segment Focus Indicator**  
The gray Segment Focus Indicator appears if you click on the Cut Row, or if you double-click on a Comp Row. A Segment is the area between two Cuts. The Segment Focus Indicator shows which segment currently has edit focus. Edit focus is required for editing using keyboard short-cuts (see the “Keyboard Commands” pdf document).
- **Cut Crossfade Zones**  
When you have comped an audio clip by creating cuts and assigning different Comp Rows to the resulting segments, it's possible to set individual crossfades between the segments. This makes it possible to get smooth transitions between the audio recordings in the different segments. Any crossfades are indicated by boxes. The widths of the boxes indicate the crossfade times.

- **Cut Handles and Cut Lines**

Each cut in a comped audio clip is indicated by a Cut Handle and a Cut Line. The Cuts indicate where the playback changes from one segment to another (in most situations from one Comp Row to another). You can edit the Cut positions by clicking and dragging any of the Cut Handles or Cut Lines sideways.

- **Silence Row**

The Silence Row can be used for inserting silent segments in the comped audio clip, e.g. for removing breath noise between vocal phrases.

- **Comp Rows**

All of your audio recordings reside on Comp Rows. Depending on how you recorded the audio clip, there might be one or several Comp Rows, each containing one audio recording. The most recent take is on the topmost Comp Row. In a Comp clip, the colored part(s) of each Comp Row (or Silence Row) will play back. All Comp Rows used in the clip have colored Comp Row Handles. Any unused Comp Rows in the clip are indicated by gray Comp Row Handles.

## The relationship between Clips, Comp Rows and Recordings

In the Comp Editor, the contents of an open clip are displayed on the Comp Row(s) on the Edit Pane:

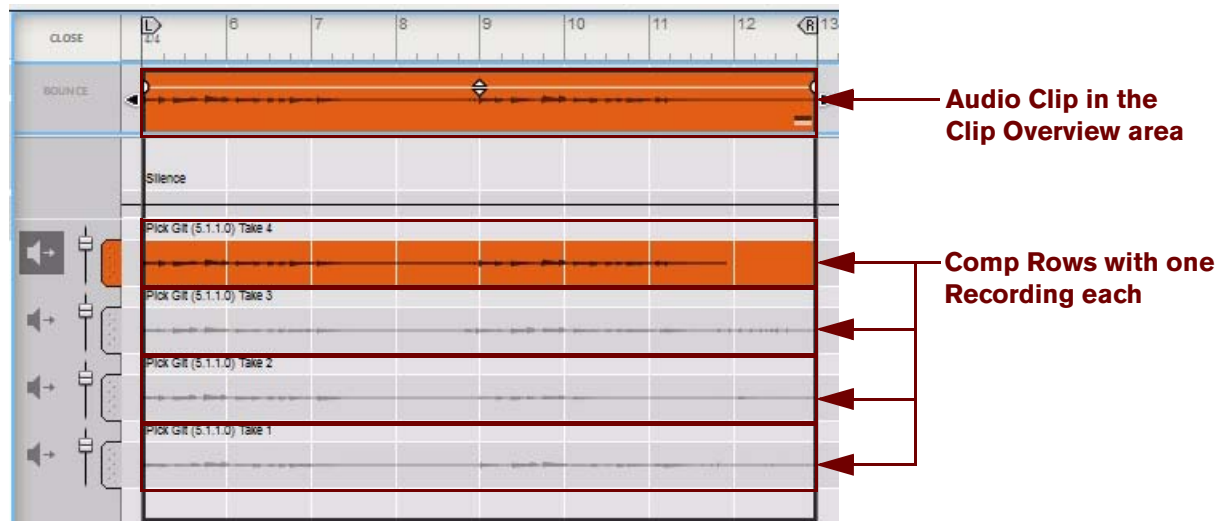

*A Single Take clip with four Comp Rows, with the topmost Comp Row manually selected for playback.*

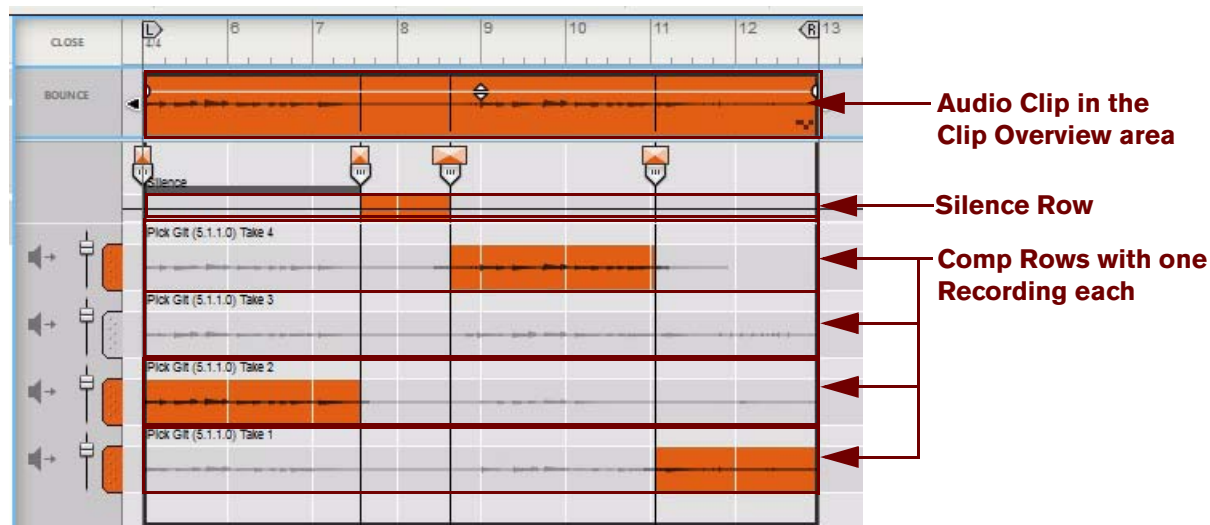

*A Comp clip with alternating playback from four Comp Rows.*

- **A recorded audio clip, or an audio clip containing imported audio, can consist of one or several Comp Rows.**  
The number of Comp Rows and their position can be unique for each individual audio clip. Any edits you make in an audio clip will never interfere with other clips in the Song.
- **On each Comp Row there is one single Recording, i.e. the audio that you have recorded or imported.**  
If the clip was recorded in one single take, it will have a single Comp Row. If the clip was recorded in several takes one after another, or recorded in Loop Mode, it will contain one Comp Row for each take or loop. Also, if you imported audio files to a clip, each audio file will end up on a separate Comp Row.

- **Only one Comp Row can play back at a time.**

In a Single Take clip with more than one Comp Row, only the Comp Row you have selected by clicking the Single Take Mode button will play back. In a Comp clip, you can alternate the playback between the Comp Rows by assigning regions of the different Comp Rows to different Segments in the Clip. What you hear when you play back an audio clip is displayed in the Clip Overview area at the top on the Edit Pane. (The Clip Overview area displays the same content as the clip in the Arrange View.)

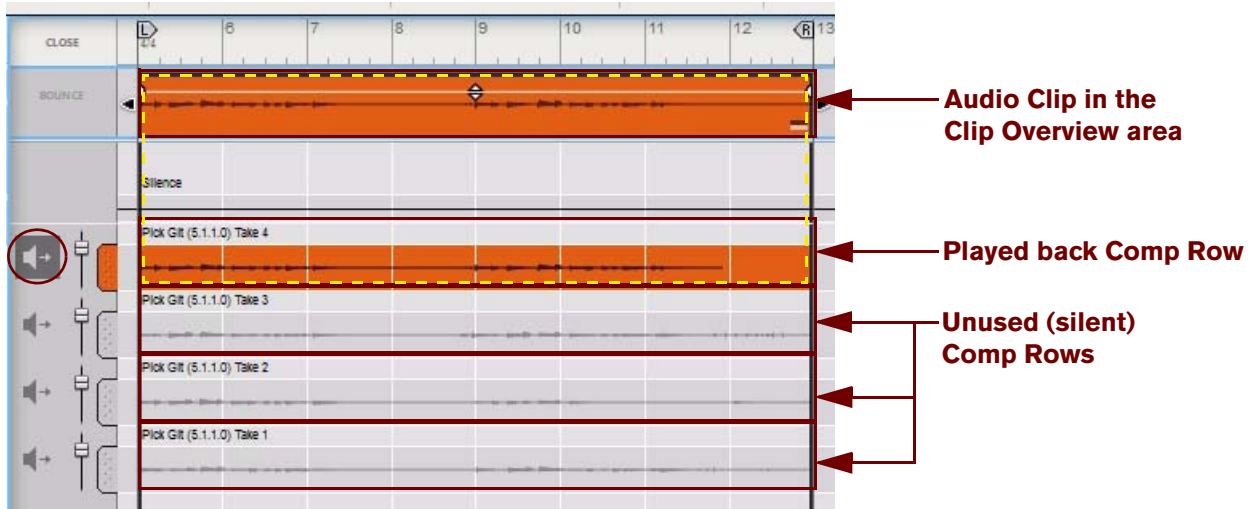

*A Single Take clip with four Comp Rows, with the topmost Comp Row manually selected for playback.*

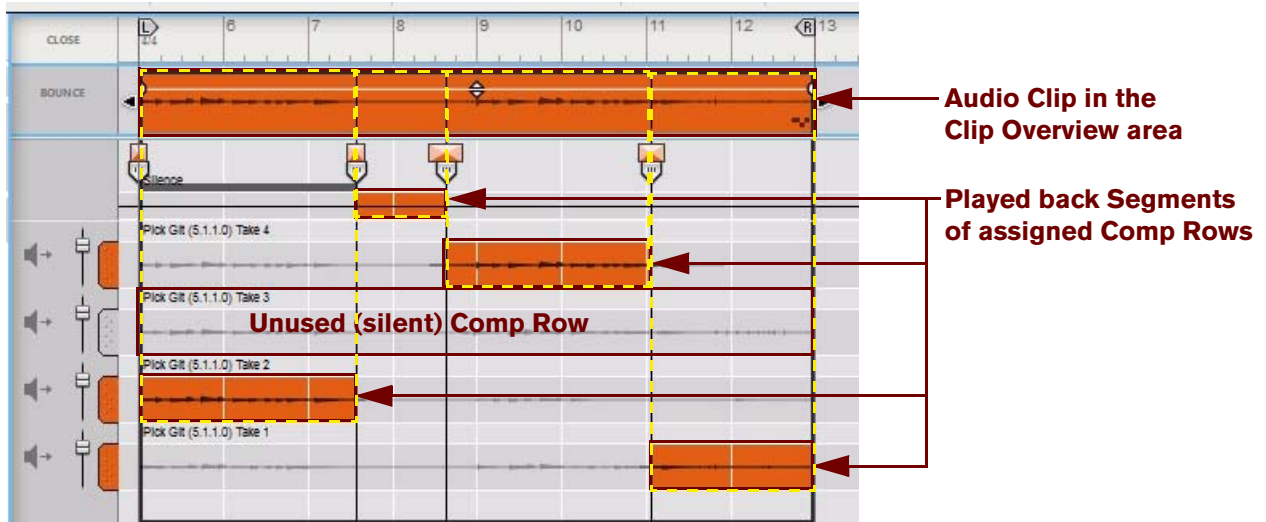

*A Comp clip with alternating playback from three Comp Rows plus the Silence Row.*

- **The Comp Row configuration, and the Recordings on the Comp Rows, are unique to each individual audio clip.** This means that you could move Comp Rows up or down on the Edit Pane, change Comp Row Levels and Cross-fades, or move Recordings back and forth on the Comp Rows, without affecting any neighboring audio clips.
- **If you duplicate a Clip, or a Comp Row with its Recording, you can freely edit the duplicated Clip, Comp Row or Recording without affecting the original.**

However, the actual audio data is not duplicated. Reason features a very sophisticated internal audio management system which re-uses Recordings throughout the entire Song whenever necessary. This means that the Song file size won't increase when you duplicate audio clips or Comp Rows.

# Comp Editor window handling

## Resizing, zooming and scrolling

- The Magnifying Glass tool can be used for zooming in and out (see “[Magnifying Glass Tool](#)”).
- The Hand tool can be used for scrolling the view in any direction (see “[Hand Tool](#)”).
- Use the Song Navigator to scroll and zoom horizontally (see “[Areas, windows and basic navigation](#)”).
- Click on a Song Navigator Handle and drag horizontally to zoom in and out horizontally (see “[Areas, windows and basic navigation](#)”).
- Shift-click on a Song Navigator Handle and drag horizontally to zoom in and out horizontally, symmetrically (see “[Areas, windows and basic navigation](#)”).
- Right-click (Win) or Ctrl-click (Mac) inside the Song Navigator frame and drag up or down to zoom in and out and scroll at the same time (see “[Areas, windows and basic navigation](#)”).
- Use the Track Navigator to scroll vertically in the Track List (see “[Areas, windows and basic navigation](#)”).
- Click the Zoom buttons below the Track Navigator to zoom in and out vertically (see “[Areas, windows and basic navigation](#)”).
- For extensive editing, you may want to maximize the Sequencer and/or detach the Main Mixer and Rack so that the sequencer covers the entire computer screen. Refer to “[Areas, windows and basic navigation](#)”.

## Comp Editor audio editing tools

When editing audio in the Comp Editor, some of the Toolbar tools have different functionality as when editing note and automation clips. There are also some additional tools that are unique to audio editing.

### Razor (Cut) Tool

When editing audio in the Comp Editor, the Razor Tool on the sequencer Toolbar is used for creating Cuts. When you place the Razor Tool over the Comp Rows, Silence Row or Cut Row, it changes into a “Cut Tool”.

- With the Selection Tool selected, hold down [Alt](Win) or [Cmd](Mac) to temporarily switch to the Cut Tool.
- Click with the Razor Tool on a Comp Row to assign the recording to the right of the cursor to a new Segment.

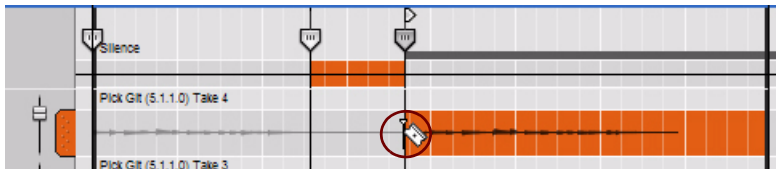

*Assigning the recording on the “Take4” Comp Row to a new segment.*

See “[Adding Cuts](#)” for more details on how to use the Cut Tool.

The Razor Tool can also be used for assigning a complete Segment, with a start and end Cut, by clicking and dragging (swiping) the Razor Tool horizontally on the desired Comp Row. See “[Adding Segments](#)” for more details on how to swipe with the Cut Tool.

### Speaker Tool

It's possible to audition individual recordings on Comp Rows, without needing to start playback of the sequencer. This is very useful when you're going to select what Comp Rows to use in the clip:

**1. Make sure the Speaker Tool is selected and place the cursor at the position on the Comp Row you would like to audition.**

The cursor switches to a speaker symbol with crosshairs next to it.

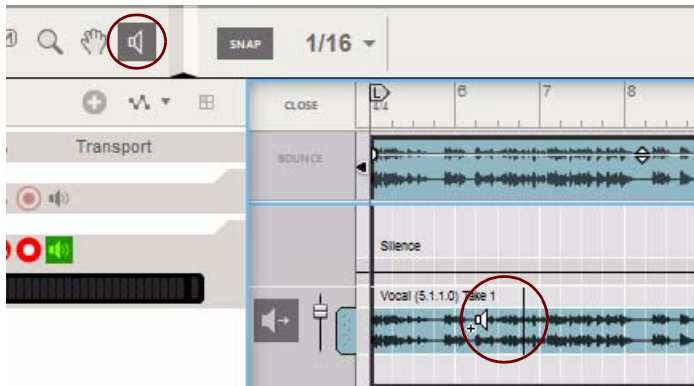

*Auditioning a recording on a Comp Row.*

**2. Click and hold the mouse button depressed for as long as you want to listen.**

The playback starts at the current crosshairs position and proceeds for as long as you keep the mouse button depressed. The playback position is indicated by a vertical moving line on the auditioned Comp Row.

- With the Selection Tool (Arrow) selected, holding down [Alt]+[Shift](Win) or [Cmd]+[Shift](Mac) will switch to the Speaker Tool.

! Note that auditioning recordings on Comp Rows will play back the unprocessed sound of the recording - bypassing any settings in the Main Mixer.

- Using the Speaker Tool, it's possible to audition recordings anywhere on any Comp Rows. The Comp Row doesn't have to be selected - it's even possible to audition recordings on masked Comp Row segments.

## Selecting a Comp Row for playback in a Single Take clip

In a Single Take clip, only the selected Comp Row will play back throughout the entire clip length. It's also possible to change Comp Row Levels and Recording Offsets in a Single Take clip. The picture below shows an open Single Take clip in the Comp Editor. The clip consists of four separate takes, each on a separate Comp Row. When played back, the recording on the selected "Take 4" Comp Row will play back:

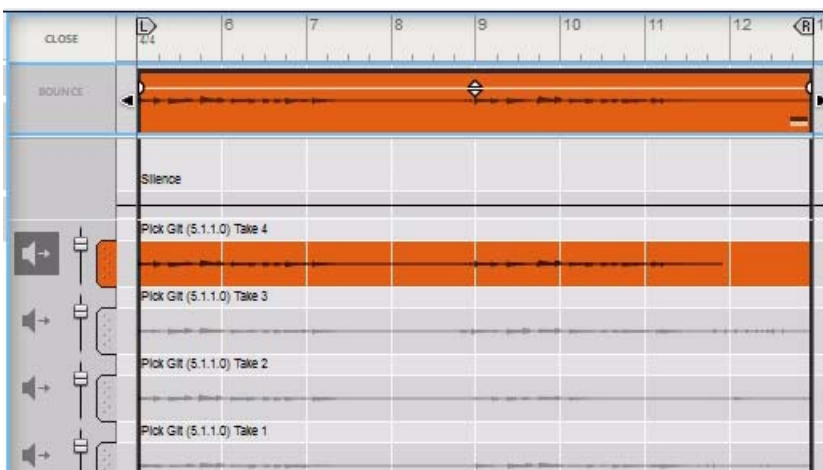

*A Single Take clip open in the Comp Editor with four recorded takes.*

If you want to change which Comp Row should play back in a Single Take clip:

- **Click the Single Take Mode button for the Comp Row you want to play back.**

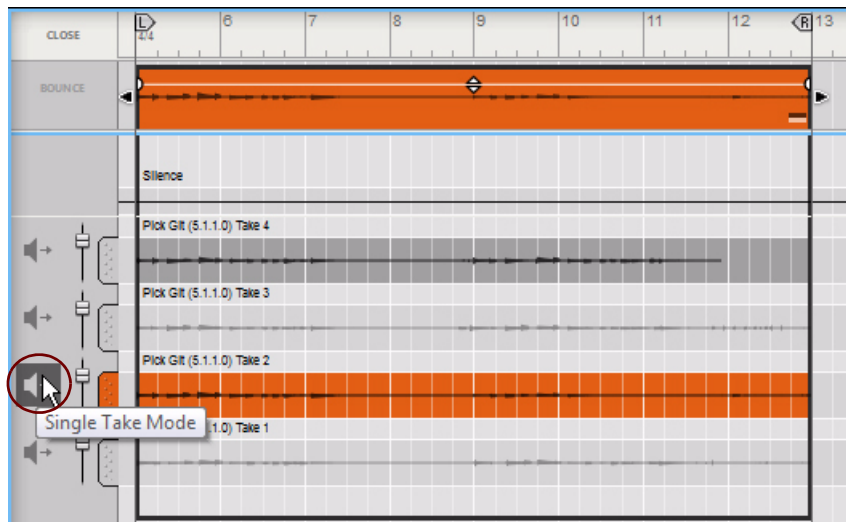

The "Take 2" Comp Row is now manually selected for playback throughout the clip.

Now, the "Take 2" Comp Row will play back instead when the sequencer is started.

## Selecting Comp Rows

- **To select a Comp Row, e.g. for moving, cutting, copying, duplication or deletion, click (don't double-click!) with the Selection Tool anywhere on the Comp Row, or on the Comp Row Handle.**

The selected Comp Row is shown in a darker color:

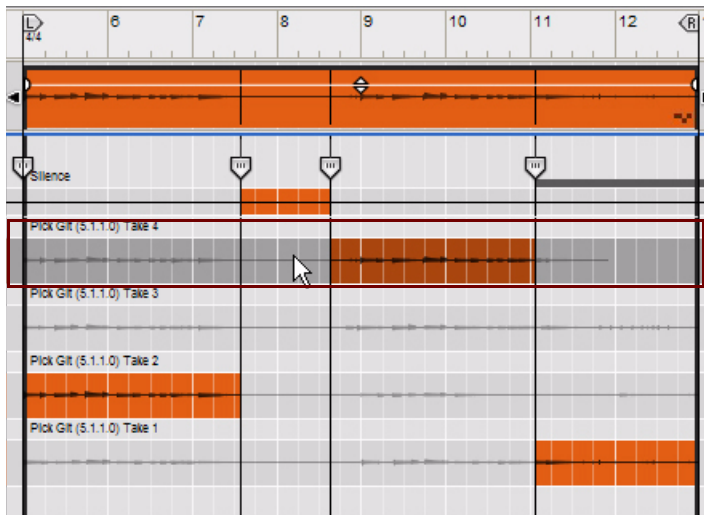

The selected Comp Row is shown in a darker color.

- **Select multiple Comp Rows by holding down [Ctrl](Win) or [Cmd](Mac) and clicking with the Selection Tool.**
- **Select a range of Comp Rows by holding down [Shift] and clicking with the Selection Tool on the first and last Comp Row in the desired range.**
- ! **Don't double-click on a Comp Row to select it. Double-clicking on a Comp Row will automatically assign the recording on it to the segment at the current click position.**

## Deleting Comp Rows

- Select one or several Comp Rows (see **“Selecting Comp Rows”**) and then press [Backspace] or [Delete], or select **“Delete”** from the Edit menu or context menu.
- Alternatively, select the Eraser Tool and click anywhere on the Comp Row you wish to delete.

## Moving Comp Rows

Moving Comp Rows up or down on the Edit Pane can be useful to make it faster and easier and to access the desired Comp Rows when editing a comped clip. Let's say you have recorded six takes but you're only going to edit takes 1, 3 and 5. In this case, it would be more practical to have these Comp Rows right below one another at the top of the Edit Pane.

- **To move a single Comp Row up or down, click and hold the Comp Row Handle and drag vertically.**  
A red insertion line is shown, indicating where the Comp Row will be placed after you release the mouse button.

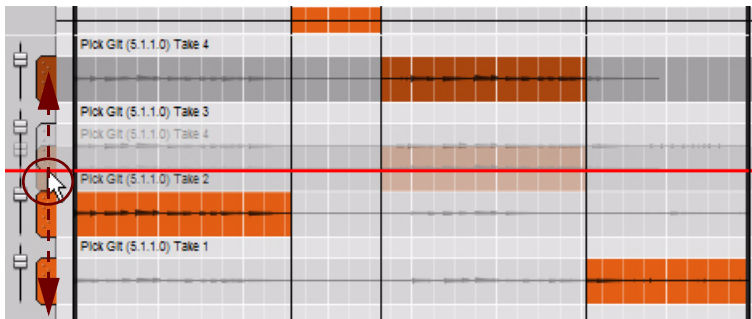

*Moving a Comp Row.*

- **To move several Comp Rows in one go, select them and then click and hold one of the selected Comp Row Handles and drag to the new destination.**  
A red insertion line is shown, indicating where the Comp Rows will be placed after you release the mouse button. Note that if you move non-adjacent Comp Rows, they will be placed as a group (adjacent) on the Edit Pane.
- **To move Comp Rows between clips, use the cut/copy and paste functions described in **“Cutting, copying and pasting Comp Rows”**.**
- **Moving Comp Rows sideways is the same as changing the Recording Offsets - see **“Adjusting the Recording Offset”** for more details.**

## Duplicating Comp Rows

Duplicating Comp Rows can be useful if you want to re-use the same part of a take several times in a comped clip. Duplicate the Comp Row and then adjust the Recording Offset (see **“Adjusting the Recording Offset”**) in the duplicated Comp Row to access the same part of the recording in another segment of the comped clip. Duplicating Comp Rows will not use up any more space on your hard disk, so you can do this as many times as you like.

- **To duplicate one or several Comp Rows, select them and hold [Ctrl](win) or [Cmd](Mac) and press [D], or select **“Duplicate Comp Rows”** from the Edit menu or context menu.**  
The duplicated Comp Rows will be placed below the lowest selected Comp Row. Note that if you duplicate non-adjacent Comp Rows, they will be placed as a group (adjacent) below the lowest selected Comp Row.
- **You can also duplicate a Comp Row and assign the duplicated Comp Row to a new segment in one go. With the Razor (Cut) Tool selected, hold down [Ctrl](Win) or [Option](Mac) and click, or swipe, on a Comp Row to assign a new segment to a duplicate of the recording on a new, additional Comp Row.**



## Cutting, copying and pasting Comp Rows

To move recordings between clips, you can cut or copy and paste Comp Rows as follows:

- 1. Select one or several Comp Rows and then hold [Ctrl](Win) or [Cmd](Mac) and press [X] to cut or [C] to copy the Comp Rows to the clipboard memory.**  
Alternatively, select “Cut” or “Copy” from the Edit menu or context menu.
  - 2. Open the audio clip into which you want to paste the Comp Row(s).**  
This can be in the same song or a different one.
  - 3. To paste the cut or copied Comp Rows, hold down [Ctrl](Win) or [Cmd](Mac) and press [V] - or select “Paste” from the Edit menu or context menu.**  
The pasted Comp Rows will be placed at the top of the Edit Pane. Note that if you paste non-adjacent Comp Rows, they will be placed below each other, starting at the top of the Edit Pane.
- ! If you paste Comp Rows into another song, the actual audio recordings will be added to that song as well and consequently increase the file size.**

## Adjusting the Comp Row Level

If you are comping different Takes where the levels differ a bit, you might want to adjust the levels individually for the Takes:

- 1. Click on a Comp Row to select it.**  
The Comp Row is displayed in a darker color to indicate it's selected.
- 2. Adjust the level, either by clicking and dragging the Comp Row Level Fader, or by adjusting it in the Level (dB) display in the Inspector.**  
The Level (dB) display is divided into dB and 1/100th of a dB.

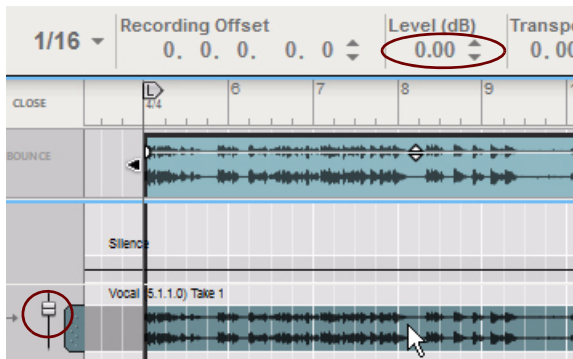

*Adjusting the audio level of a recording on a Comp Row.*

- 3. Repeat the procedure for the other Comp Rows, if necessary.**
- **It's also possible to edit the entire Clip Level in the Comp Editor by clicking and dragging the Clip Level Handle in the Clip Overview.**  
Any level adjustments you make on the Comp Row and in the Clip Overview are summed.

# Adjusting the Recording Offset

In some situations you might want to move, or nudge, the entire recording on a Comp Row to make it play back exactly when you want. Maybe you just need to fine tune the position by a couple of Ticks:

1. Click on the Comp Row to select it.
2. Either click and drag the recording horizontally, or adjust the position in the Recording Offset display in the Inspector.

The Recording Offset display is divided into Bars, Beats, 1/16th notes, Ticks and Subticks. There are 240 Ticks for each 1/16th note and 16 Subticks for each Tick.

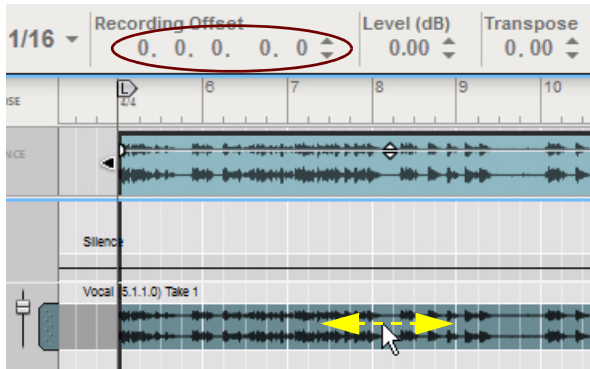

The "Recording Offset" display shows the offset of the recording on the selected Comp Row relative to the Clip Position.

If you move the recording on the selected Comp Row back or forth, the Offset Display will update. Similarly, if you resize the Clip by changing its start position (left Clip Handle), the Offset Display will also update.

However, if you resize the clip using its right Clip Handle, or move the entire clip, all recordings on all Comp Rows will follow along and the Recording Offset will remain unaffected.

*Adjusting the offset (position) of a recording on a Comp Row.*

You can also nudge the Recording Offset of the selected recording by using the arrow keys on the keyboard.

- To nudge the recording in Snap value steps, hold [Ctrl](Win) or [Cmd](Mac) and press the left/right arrow keys. Note that Snap doesn't have to be activated for this to work.
- To nudge the recording in steps of Ticks, hold [Ctrl]+[Alt](Win) or [Cmd]+[Opt](Mac) and press the left/right arrow keys.
- To nudge the recording in steps of Beats, hold [Ctrl]+[Shift](Win) or [Cmd]+[Shift](Mac) and press the left/right arrow keys.
- To make it easier to find the exact positions in the recording, you can audition the recording at desired positions (see "Speaker Tool").

## Delete Unused Recordings

After you have edited your audio clips in the Comp Editor, there might be unused recordings left on Comp Rows that you don't plan to use. To reduce the file size of your song, you can choose to delete all unused recordings in one or several audio clips.

- Select the clip(s) in the Clip Overview area in the Comp Editor, or select the clip(s) in the Arrange View, and then select "Delete Unused Recordings" from the Edit menu or context menu. All recordings that are not used in the clip(s) will be permanently deleted.
- If a clip is in Single Take Mode, only the selected Comp Row will be played back - all other Comp Rows are per definition "unused". However, there may still be Cuts and assigned Segments among these Comp Rows, visible and audible if you switch the clip to Comp Mode. As a safety measure, if you use the "Delete Unused Recordings" function on such a clip, you will be asked to confirm that you really want to remove all Comp Rows other than the selected one.
- After deleting audio recordings, you will have to use the "Save and Optimize" function on the File menu to minimize the Song file size - see "Saving and optimizing a Song".

## Bounce Clip(s) to New Sample(s)

You can bounce one or several Audio Clips to new Song Samples. You could then edit the samples in the Edit Sample window and then load into a sampler device for playback. Proceed as follows:

- **Select the clips in the Clip Overview area in the Comp Editor, or select them in the Arrange View, and then select “Bounce > Bounce Clip(s) to New Sample(s)” from the Edit menu or context menu.**

The Audio Clips are bounced to new Song Samples and named according to the Audio Clip name (if the clip was named) or according to the Audio Track name with serial numbers. The bounced Audio Clips then end up as sample files in the Song Samples location in the Browser. Refer to [“Sampling”](#) for more details about sampling and sample editing.

### About the “Bounce Clip to Disk” function

The “Bounce > Bounce Clip to Disk” function on the Edit menu and clip context menu allows you to export the audio of a selected clip to disk as a single WAV or AIFF file. This might be useful if you want to process an audio clip in an external application and then re-import the clip to the track again. See [“Bouncing Audio Clips”](#) for more details.

# Normalizing Clips

Normalizing means increasing the overall audio level so that the loudest peak in the sound touches 0 dB. Normalizing can be made on any audio clips, regardless of if they are Single Take clips or Comp clips.

**1. Select the Audio Clip(s) in the Arrange View, or in the Clip Overview in the Comp Editor.**

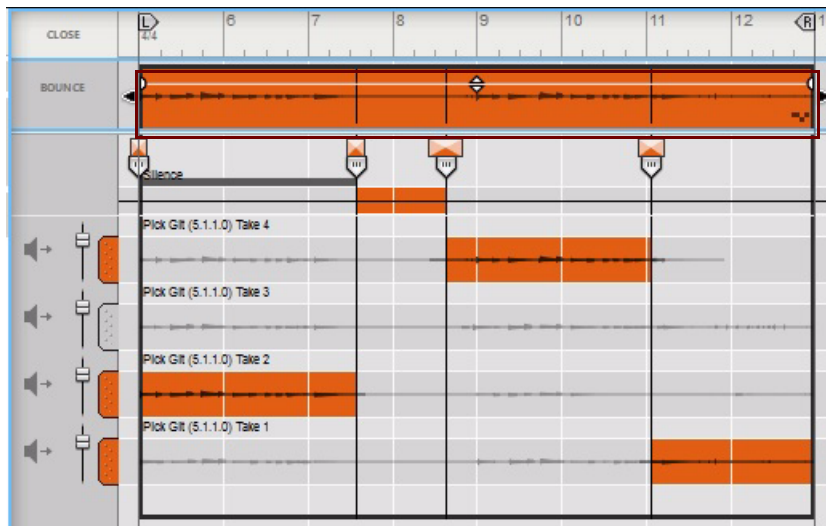

*A comped audio clip selected in the Clip Overview in the Comp Editor.*

**2. Select “Normalize Clips” from the Edit menu or context menu.**

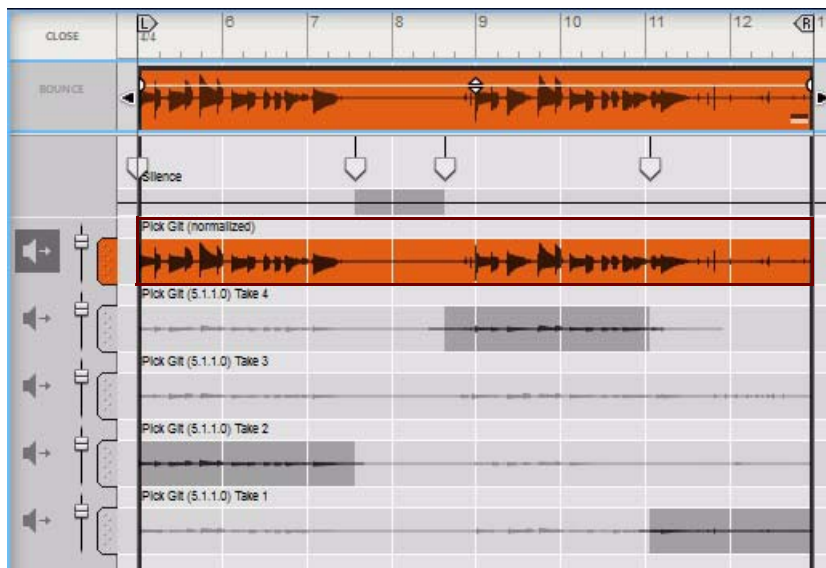

A new Comp Row is automatically created at the top and named after the Audio Track, with the extension “(normalized)”. The new Comp Row contains the “bounced” normalized audio and the Audio Clip has also automatically switched to Single Take Mode. The original audio is preserved on their original Comp Rows.

- ! **Only the audio within the Audio Clip boundaries will be normalized. Any masked audio will be disregarded.**
- ! **Note that normalizing a clip that contains audio that already use the full headroom (touches 0 dB) won't have any effect.**
- ! **When you normalize a Single Take clip, Reason automatically re-analyzes the audio and distributes new Slice Markers at the detected transients.**

# Reversing Clips

Reversing an audio clip means playing it backwards, from the end to the start. Reversing can be made on any Audio Clips, regardless of if they are Single Take clips or Comp clips.

**1. Select the Audio Clip(s) in the Arrange View, or in the Clip Overview in the Comp Editor.**

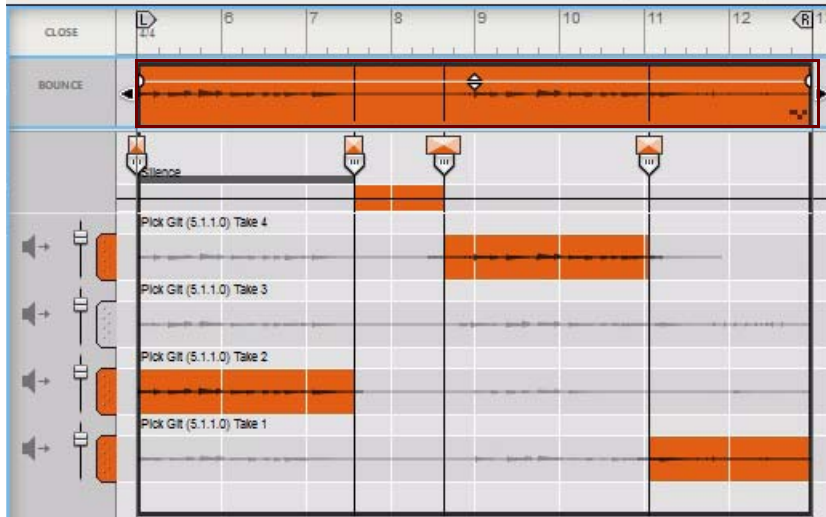

*A comped audio clip selected in the Clip Overview in the Comp Editor.*

**2. Select “Reverse Clips” from the Edit menu or context menu.**

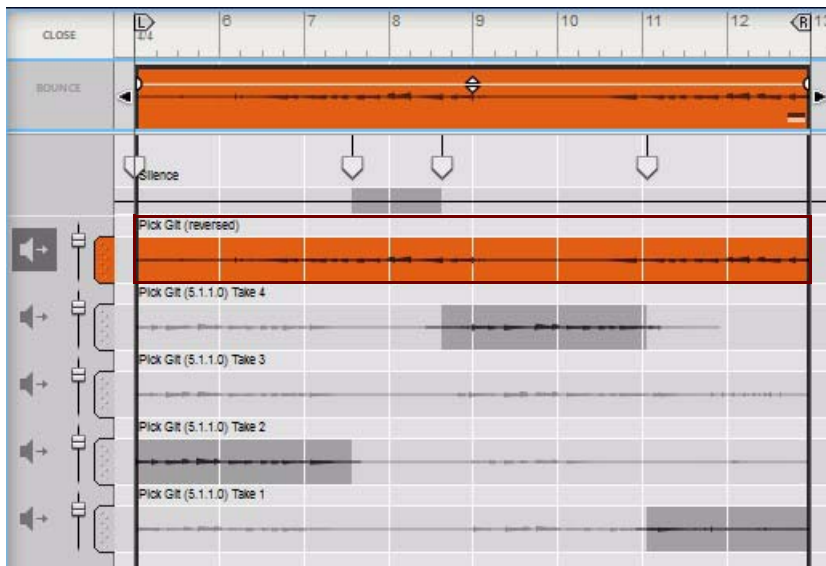

A new Comp Row is automatically created at the top and named after the Audio Track, with the extension “(reversed)”. The new Comp Row contains the “bounced” reversed audio and the Audio Clip has also switched to Single Take Mode. The original audio is preserved on their original Comp Rows.

- ! **Only the audio within the Audio Clip boundaries will be reversed. Any masked audio will be disregarded.**
- ! **When you reverse a Single Take clip, Reason automatically re-analyzes the audio and distributes new Slice Markers at the detected transients.**

# Comping audio

In this section we will describe procedures that are specific to audio editing in Comp clips. At the end of this section is a detailed example on how to use the various procedures to create a complete comped audio clip - see [“Creating a comped audio clip”](#). General audio editing procedures are described in [“Editing audio in the Comp Editor”](#).

## Adding Cuts

- ! **If the clip is in Single Take Mode, because a Single Take Mode button is depressed, you will have to click that Single Take Mode button to deselect the Comp Row before you can start adding Cuts!**
- ! **If the clip only contains one single (not manually selected) Comp Row, and thus is a Single Take clip, adding a Cut on the Silence Row will automatically turn the clip into a Comp clip.**
- **Place the Razor Tool on the Comp Row which contains the recording you want to assign, and click.**  
A new Cut Handle is added on the Cut Row. The recording to the right of the Cut Line on the Comp Row is assigned to a new Segment:

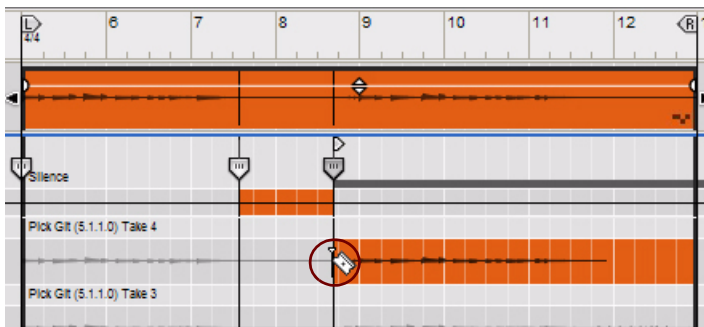

*Assigning the recording on the “Take4” Comp Row to a new Segment.*

- **Click with the Razor Tool on the Silence Row to assign silence to a new Segment to the right of the cursor.**
- **Click with the Razor Tool on the Cut Row to create a new Cut without changing the currently assigned recording.**  
A new Cut Handle is added on the Cut Row. The previous recording assignment is retained throughout the new segment.
- **If you hold down [Ctrl](Win) or [Option](Mac) and click with the Razor tool on a Comp Row, this will first create a duplicate of the Comp Row. Then, the duplicated Comp Row will be assigned to the new Segment.**  
You can then adjust the timing (Recording Offset) or level of the duplicated Comp Row as needed, without affecting any segments playing the original Comp Row.
- ! **Note that Snap is taken into account (if activated).**
  - A quick way to toggle Snap on or off is to press [S].
  - For a practical example on how to add Cuts, see [“Creating a comped audio clip”](#).
  - It’s also possible to assign a complete Segment, with a start and end Cut, by swiping with the Cut Tool on the Comp Rows - see [“Adding Segments”](#).

## Adding Segments

The Razor Tool can be used for assigning a complete Segment, with a start and end Cut, by clicking and dragging (swiping) the Razor Tool horizontally on the desired Comp Row.

- **Swipe (click-hold and drag) with the Razor Tool to assign a part of a Comp Row to a new segment.**

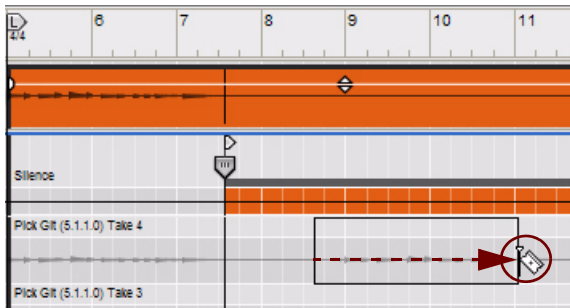

*Place the Razor Tool on the desired start position on a Comp Row and swipe...*

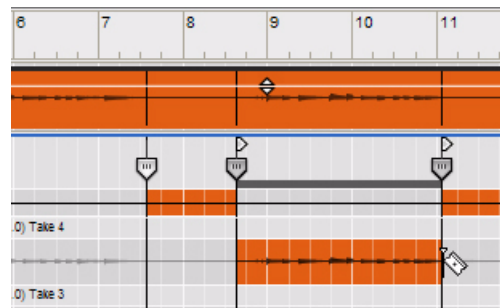

*...and release where you want the segment to end.*

- **To insert a new Segment in an existing Segment, swipe with the Razor Tool on a Comp Row or on the Cut Row.** Swiping on a Comp Row will automatically assign the recording on that Comp Row to the new segment. Swiping on the Cut Row will insert a new segment but won't change the recording assignment. The result after inserting a new segment in an existing segment is three separate segments. Swiping over an existing Cut will remove that Cut.
- **If you hold down [Ctrl](Win) or [Option](Mac) and click or swipe with the Razor tool on a Comp Row, this will first create a duplicate of the Comp Row. Then, this duplicated Comp Row will be assigned to the new Segment.** You can then adjust the timing (Recording Offset) or level of the duplicated Comp Row as needed, without affecting any segments playing the original Comp Row.
- ! **Note that Snap is taken into account (if activated).**
  - A quick way to toggle Snap on or off is to press [S].
  - For a practical example on how to add a Segment, see [“Creating a comped audio clip”](#).

## Adding Crossfades to Cuts

To add a crossfade zone to a Cut (between two Segments), proceed as follows:

- **Select a Cut Handle and then drag the Cut Crossfade Handle to the right.**

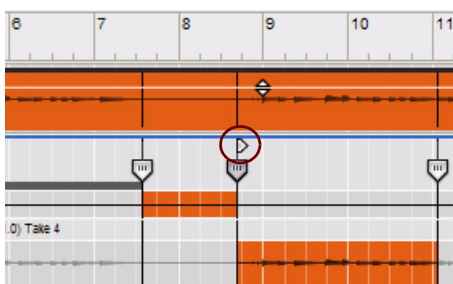

*Click and drag the Cut Crossfade Handle...*

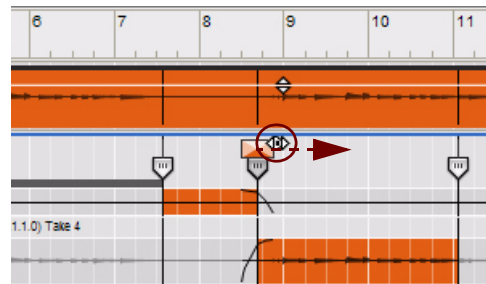

*...to introduce a crossfade between the segments.*

The crossfade slopes are indicated by curves on the assigned Segments. The longer the crossfade time, the flatter the curves.

- **To remove a crossfade, simply drag the Cut Crossfade Handle all the way to the left.**

## Deleting Cuts

- **To delete a Cut, click on the left Cut Handle and press [Backspace] or [Delete], or select “Delete” from the Edit menu or context menu.**

The segment to the right of the deleted Cut will be deleted. The segment to the left of the deleted Cut will expand and replace the deleted segment:

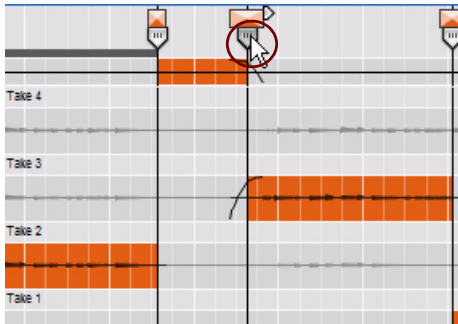

*Click on a Cut Handle to select it.*

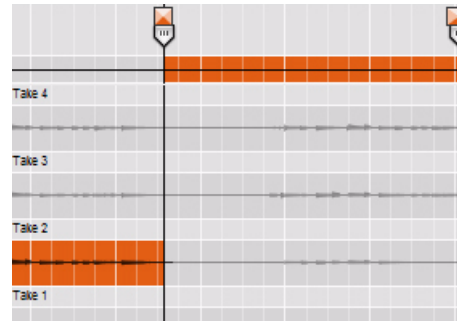

*Press [Backspace] or [Delete] to delete the segment to the right of the Cut Handle.*

- **Alternatively, select the Eraser Tool and click on the Cut Handle.**

## Moving Cuts

Moving Cuts has a similar effect to resizing a clip, i.e. you select what part of the recording on the Comp Row should be active for playback. Recordings outside the active segment on the Comp Row will be masked (silent) but not affected in any other way.

- **To move a Cut, click and hold its right Cut Handle, or Cut Line, and drag it horizontally in either direction.**

The segment to the left of the Cut Line will be resized. The segment to the right of the resized segment will now have a new start position:

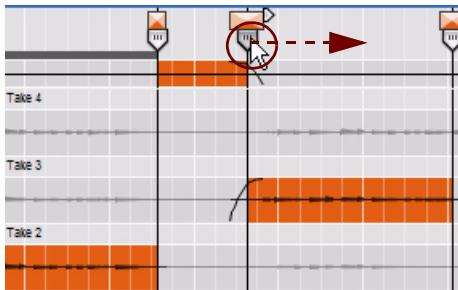

*Click on a Cut Handle to select it.*

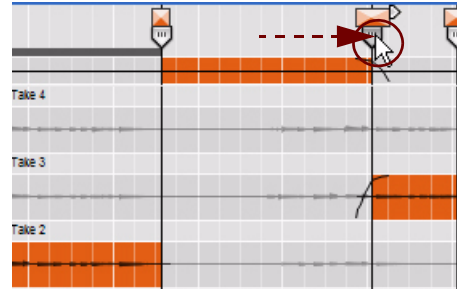

*Drag the Cut Handle to horizontally to move it.*

- ! **Recordings in the segments will not be moved back or forth - only masked according to the current positions of the Cut Handles/Lines. Any Cut Crossfades will also move along with the Cut Handles/Lines.**
- ! **Two Cuts can never exist on the same position. If you drag a Cut to the position of another Cut and release the mouse button, the moved Cut will disappear. If you do this by mistake, you can always use the Undo function.**
- **To move a Cut and have the recording on the Comp Row move along with the Cut, select the Comp Row and the Cut Handle using the standard [Ctrl]-click (Win) or [Shift]-click method. Then, click and drag the Cut to the desired position.**
- ! **Note that Snap is taken into account (if activated).**
- **It's also possible to use the Inspector to move Cuts numerically - see “Editing recordings and cuts in the Inspector”.**



## Changing Comp Row assignments

When you have created a comped audio clip, you might later want to change which Comp Rows are assigned to play:

- **Choose the Selection Tool and double-click on the Comp Row that contains the recording you want to assign to the Segment.**

Make sure you double-click in the area between the desired Segment's Cut Lines.

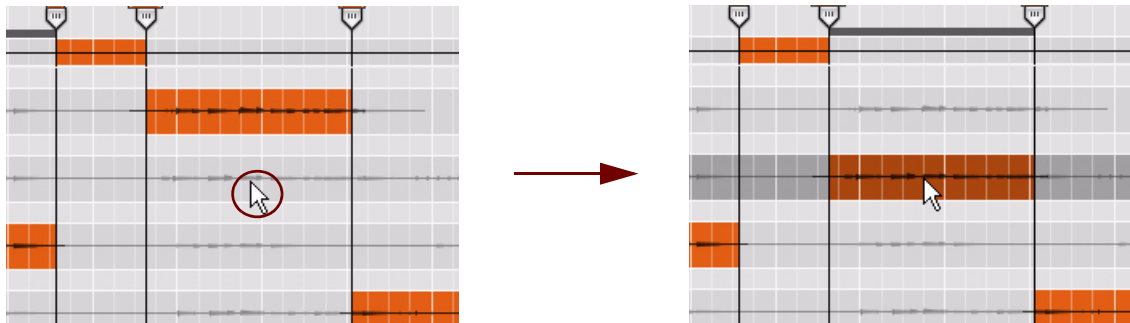

*Double-click on the Comp Row you want to assign to the segment.*

*The segment will now play back this recording instead.*

You can also use keyboard commands to change comp row assignments and segment focus as follows:

- **Hold down [Ctrl](Win) or [Cmd](Mac) and press the up/down arrow keys to select which Comp Row that should be assigned.**
- **To change Segment focus, hold down [Ctrl]+[Alt]+[Shift](Win) or [Cmd]+[Option]+[Shift](Mac) and press the left/right arrow keys.**

This will move the Segment Focus Indicator between the segments. Note that you can still change comp row assignments using this keyboard command together with the up/down arrow keys.

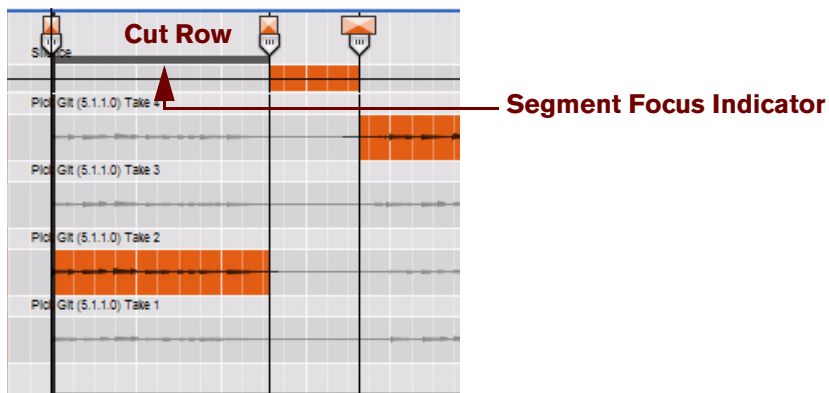

*The Segment Focus Indicator shows which segment has currently focus.*

## Bounce Clip(s) to New Recording(s)

! The function described below is exactly the same as clicking the “Bounce” button to the left in the Clip Overview, see “[Bounce button](#)”.

A very nice way to “clean up” among the recordings in a comped audio clip is to bounce the clip to a new recording. Bouncing to a new recording is also a prerequisite to be able to edit the clip inline and stretch and quantize the audio.

What happens is that the audio recordings in all segments of the comped clip, including any Cut Crossfades and individual Comp Row Levels, are combined into a single recording on an additional Comp Row. After the clip has been bounced to a new recording, you can delete the unused recordings to reduce the file size. Bouncing clips to new recordings can be made for one or several selected audio clips:

- **Select the clip(s) in the Clip Overview area in the Comp Editor, or select the clip(s) in the Arrange View, and then select “Bounce > Bounce Clip(s) to New Recording(s)” from the Edit menu or context menu.**

A new “combined” recording is created on a new Comp Row, which is created above the other Comp Rows on the Edit Pane. The new Comp Row is assigned the suffix “(bounced)”.

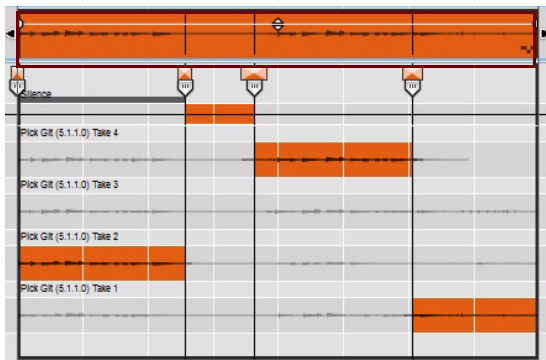

Select the clip in the Clip Overview.

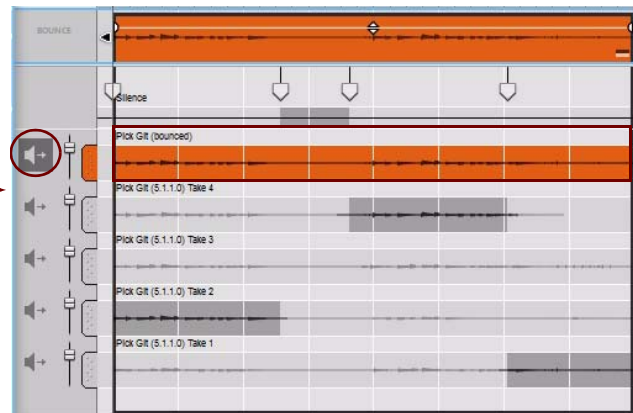

Select “Bounce Clip to New Recording” to create a new “combined” recording on an additional Comp Row.

As the clip is bounced, the clip automatically switches from a Comp clip to a Single Take clip. If you play back the clip now, you will only hear the bounced recording on the automatically selected (topmost) Comp Row. However, the clip will sound exactly the same as before the bounce.

If you're happy with the result and don't plan to edit the clip any further, you can use the “Delete Unused Recordings” function to delete the recordings on the original Comp Rows and reduce the file size (see “[Delete Unused Recordings](#)”). If file size is not an issue, you can keep the original takes in the clip. This way you can switch to Comp Mode at any time if you need to edit the comp.

- **The “Bounce Clip to New Recording” function is very useful if you have imported a large audio file and only want to use a part of it. You can bounce the part of the clip you want use to a new recording and then delete the remaining unused part on the Comp Row to reduce the file size.**
- **It's also possible to bounce Audio Clips to disk and to a Sample - see “[Bouncing Audio Clips](#)” and “[Bounce Clip\(s\) to New Sample\(s\)](#)”.**

## Creating a comped audio clip

If you have recorded more than one loop cycle of audio in Loop Mode (see “Recording audio in Loop mode”), or recorded over or into an existing audio clip (see “Recording over or into an existing audio clip”), each recording has been placed on a separate Comp Row. If you like, you can now select the best parts (segments) of the recordings on the various Comp Rows and create a final “comped” audio clip. All editing described below is non-destructive and can be changed at any time:

### 1. Open the audio clip in the Comp Editor.

Each take has generated a separate Comp Row, each with a separate recording on it. The latest take, on the top-most Comp Row, is the one that will play back.

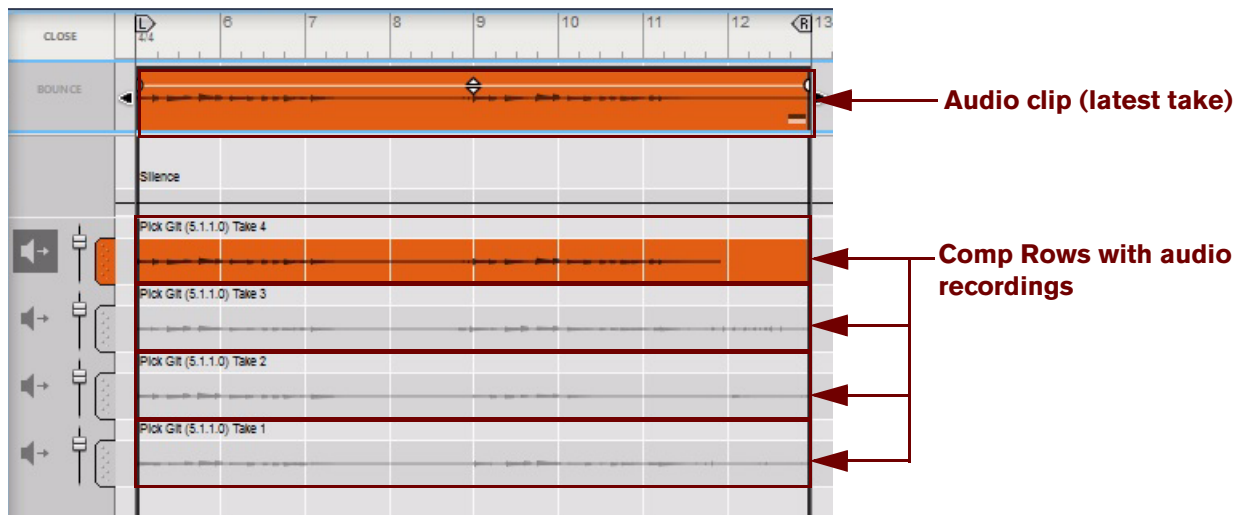

*An audio clip (in Single Take Mode) with four separate takes recorded in Loop Mode.*

! **If the clip is in Single Take Mode, because a Single Take Mode button is depressed (as in the picture above), you will have to click that Single Take Mode button to deselect the Comp Row before you can start adding Cuts!**

### 2. Locate the best parts of the recordings in the different Comp Rows.

Audition the recordings on the Comp Rows to decide which recordings to use at what position in the comped clip. Select the Speaker Tool and click-hold at desired positions on the different Comp Rows (see “Speaker Tool” for details).

➤ **If you're using the Selection Tool, you can temporarily switch to the Speaker Tool by holding down [Alt]+[Shift](Win) or [Cmd]+[Shift](Mac).**

**3. Double-click with the Selection Tool on the Comp Row you want to use first in the clip.**

In this example, we decide to use the recording on the “Take 2” Comp Row:

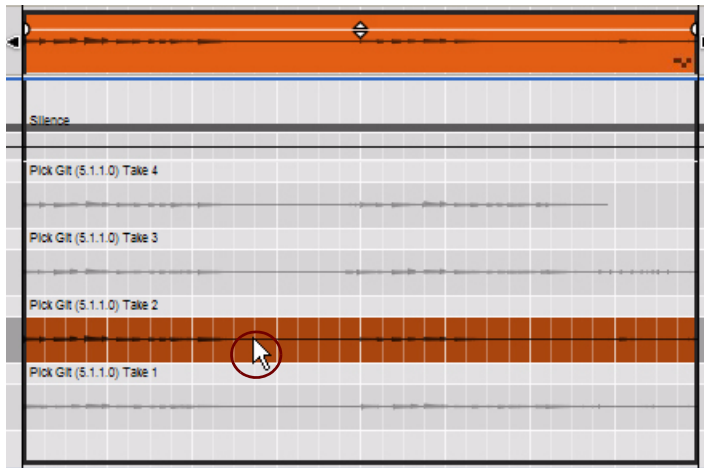

*Double-click on the “Take 2” Comp Row to assign it to the first segment of the clip.*

**4. Select the Razor Tool in the Sequencer Toolbar - or, with the Selection Tool still selected, hold down [Alt](Win) or [Cmd](Mac).**

We want the recording on the “Take 2” Comp Row to play until beat 3 of Bar 7. After beat 3 of bar 7 we want the clip to be silent to get rid of some background noise that could be heard when we recorded without playing anything. Therefore, place the Razor Tool on the Silence Row at Beat 3 of bar 7 and click:

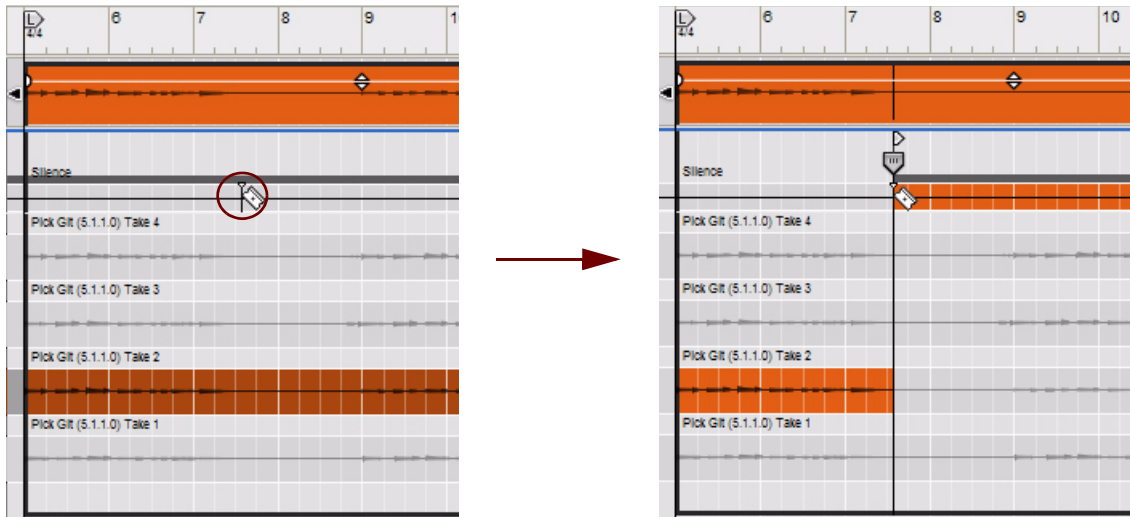

*Place the Razor Tool on the Silence Row at beat 3 of bar 7...*

*...and click to assign the Silence Row to the second segment of the clip.*

Now, you have assigned the recording on the “Take 2” Comp Row from the beginning of the clip to beat 3 of bar 7. At the same time you have assigned the Silence Row to a second segment of the clip.

**5. Use the Audition Tool to find a suitable recording to assign to a new segment in the clip.**

We found a good recording that we want to use on the “Take 4” Comp Row between beat 3 and 4 of bar 8 until beat 1 of bar 11.

### 6. Assign a complete segment by swiping with the Razor Tool.

Swipe with the Razor Tool on the "Take 4" Comp Row from beat 3 and 4 of bar 8 until beat 1 of bar 11:

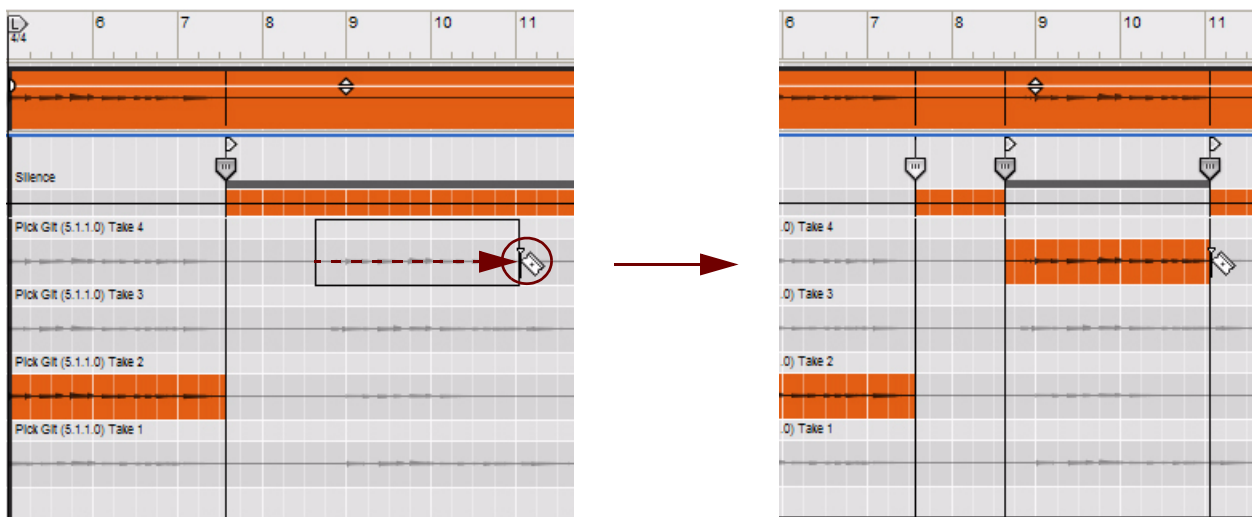

*Place the Razor Tool between beat 3 and 4 of bar 8 on the "Take 4" Comp Row and swipe...*

*...and release at beat 1 of bar 11.*

Now the recording on the "Take 4" Comp Row is assigned to a third segment in the clip. Two new Cut Handles have been added: one at the beginning of the swiped segment and one at the end.

### 7. Assign a recording to the last segment of the clip.

We used the Audition Tool and found that the recording on the "Take 1" Comp Row was just what we were looking for to play through to the end of the clip. Since a fourth segment was already created when you swiped in the previous step, you just need to double-click with the Selection Tool on the "Take 1" Comp Row, to the right of the last Cut Line, to assign the recording to the fourth segment:



*Double-click on the "Take 1" Comp Row, to the right of the last Cut Line, to assign it to the last segment in the clip.*

**8. To eliminate any clicks that might occur between the recordings in the different segments of our clip, let's introduce some crossfades.**

Crossfades can be applied by first selecting a Cut Handle and then clicking with the Selection Tool and dragging the Cut Crossfade Handles that appear above the selected Cut Handle:

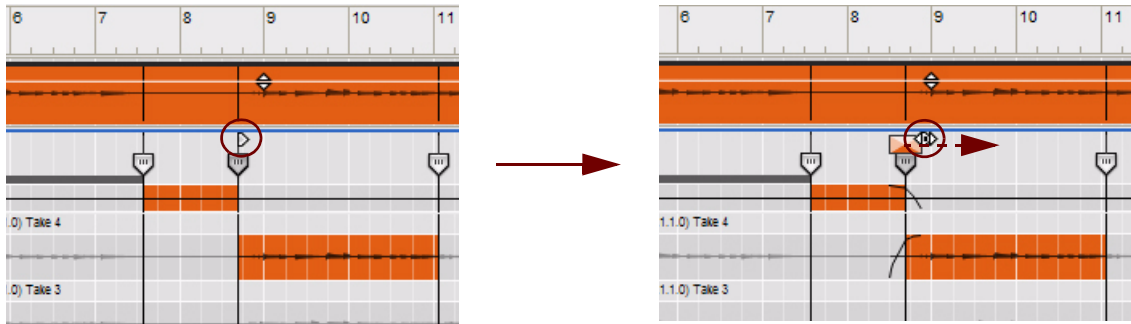

*Click and drag the Cut Crossfade Handle...*

*...to introduce a crossfade between the segments.*

The crossfade slopes are indicated by curves on the assigned Segments. The longer the crossfade time, the flatter the curves.

Repeat the procedure for the other Cut Crossfade Handles in the clip if needed.

- If you want to set the same crossfade time for several Cuts, select the Cut Handles and use the “Match Value” function in the Inspector (see “**Matching Cut Crossfades**”).

**9. Finally, you might want to trim the audio levels of the different recordings on the Comp Rows in the clip.**

Click with the Selection Tool and drag the Comp Row Level Faders on the respective Comp Row to achieve a balanced audio level throughout the clip. The Comp Row level adjustments can be made anytime during the creation of the comped audio clip.



*Adjusting the individual Comp Row audio levels.*

- If you want to set the same level for several Comp Rows, select the Comp Rows and use the “Match Value” function in the Inspector (see “**Matching Comp Row Levels**”).
  - **When you're satisfied with your comped clip, you might want to click the “Bounce” button to generate a single recording that plays back your comped audio.**  
The clip is then also automatically set to Single Take Mode, which makes it possible to edit the clip inline, where you can stretch and quantize the audio etc. See “**Editing audio inline**”.
- Bouncing also helps you keep things organized and can be a way to create a “snapshot” of your current comp, for comparison while you continue to fine-tune the edits.
- If you're finished with a comp and want to keep the file size down, you can use the “Bounce” function together with the “Delete Unused Recordings” function to permanently remove all original takes (see “**Delete Unused Recordings**”).

## Turning Comp clips into Single Take clips

After you have comped your clip in the Comp Editor you might want to continue working with it inline, to stretch individual slices, quantize the audio, etc. To be able to open the Comp clip for inline editing you need to turn the clip into a Single Take clip. Here is how:

**1. In the Comp Editor, click the “Bounce” button.**

This will render a bounced recording of your comped audio on a new Comp Row. The new Comp Row will be automatically selected, which means the clip has now become a Single Take clip.

**2. Press [Return] twice to close the Comp Editor and open the clip inline, for slice editing.**

See “[Editing audio inline](#)”.

## Changing the tempo and transposition of the audio

### Selecting Stretch and Transpose Type

When you are stretching, transposing and/or changing the tempo of the audio it's important that the Stretch and Transpose Type on the corresponding Audio Track is set according to the type of audio that's on the track. Otherwise, the sonic result might not be what you'd expect. Stretch Type can be selected as follows:

- **Select the track in the Track List, then select the desired Stretch and Transpose Type from the Edit menu or context menu.**

or:

- **Select stretch type by clicking the Stretch Type selector in the Track List when the clip is open for editing inline:**

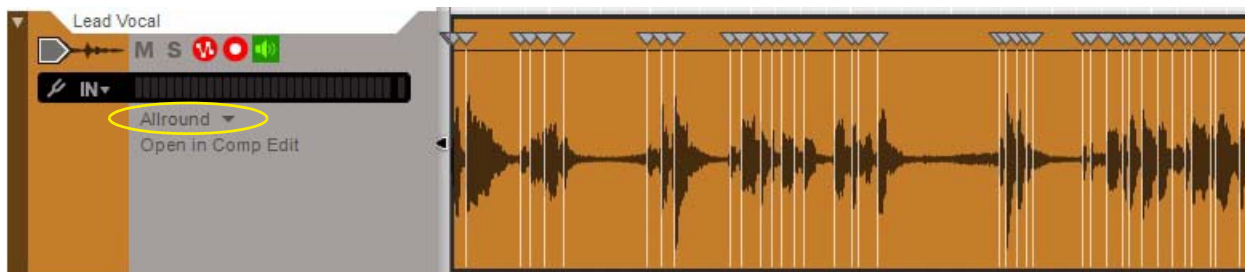

*Selecting Stretch and Transpose Type for the Audio Track in the Track List.*

- **For polyphonic material, select “Allround”.**  
The formants are transposed along with the audio.
- **For monophonic material select “Melody”.**  
The formants are transposed along with the audio.
- **For vocal select “Vocal”.**  
The formants are preserved and are not transposed along with the audio. This will keep the original character of the vocal and will only affect the pitch.

## Tempo scaling Clips

Besides the automatic time stretching function applied when you change the Tempo in the main sequencer, there is a Scale Tempo function which can be applied to scale the tempo of one or several clips. The Scale Tempo function works in the same way for audio clips, note clips and parameter automation clips. However, it might be interesting to see what happens when you tempo scale an audio clip.

**1. Open an audio clip in the Comp Editor.**

In this example we use a Comp clip with four Comp Rows and a number of Cuts. The tempo scaling works exactly the same way, regardless if the clip is a Single Take clip or Comp clip.

**2. With the Arrow Tool selected, hold down [Ctrl](Win) or [Option](Mac) and place the mouse cursor over one of the Clip Resize handles (in the Clip Overview).**

When you reach any of the Clip Resize handles, the arrow symbol switches to a “scale tempo” arrow.

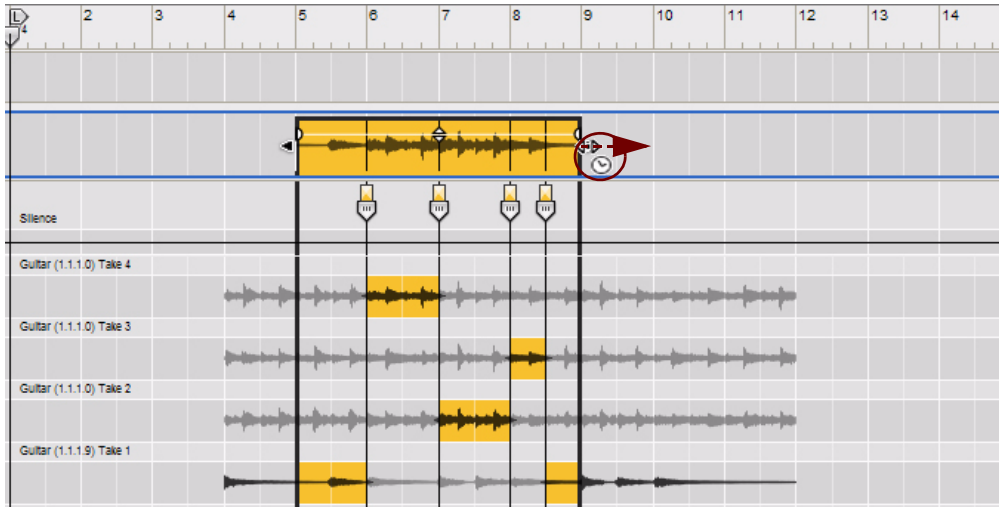

**3. Hold down [Ctrl](Win)/[Option](Mac) and click and drag the cursor sideways in either direction to scale the tempo of the clip.**

In this example, we make the clip one bar longer by dragging the right clip handle one bar to the right.

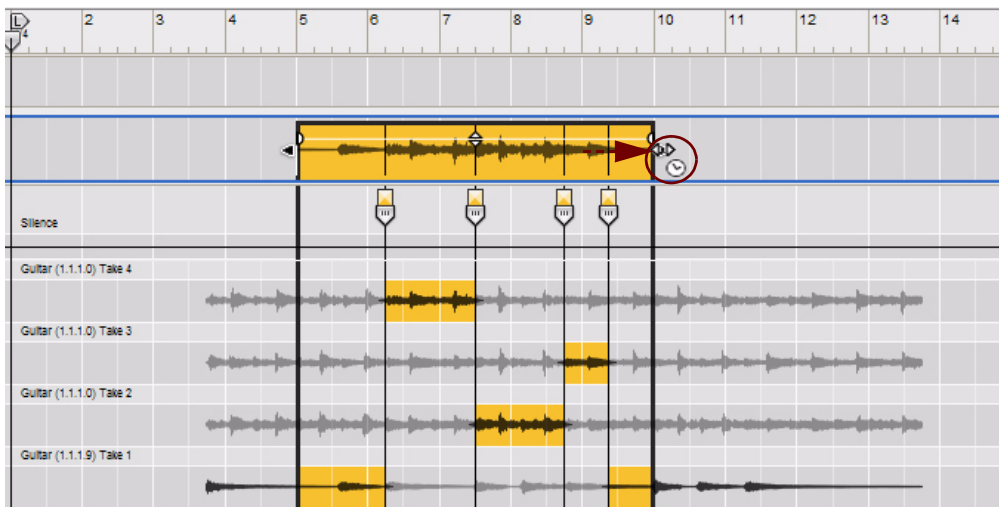

Now, the audio clip has been tempo scaled and the audio recordings have been stretched to match the new clip length. Note that the distance between the Cuts, as well as the lengths of the recordings on all Comp Rows have been expanded proportionally.

**! When you use the Scale Tempo function on Single Take clips (in Arrange Mode), the Slice Markers will follow the detected transients proportionally.**

The Scale Tempo function can also be applied to clips numerically in the Tool Window, see “Scale Tempo”.

**! When you tempo scale large clips, it could take a while before the high quality stretch is finished, see “Preview vs. High Quality Stretching”.**



# Transposing Audio Clips

Audio clips can be transposed. That is, all the audio recordings in a selected audio clip can be transposed up or down 12 semitones, in steps of 1 Cent, relative to their original pitch. The transposition can be applied to all types of audio - including polyphonic material.

- ! **The transposition is non-destructive, i.e. the original audio is always preserved and left unaffected.**
- ! **To get the best sound quality when you are transposing audio it's important that you have selected the correct Stretch and Transpose Type for the audio track, see “[Selecting Stretch and Transpose Type](#)”.**

## 1. Select one or several audio clips.

The Transpose display shows up to the right in the Inspector:

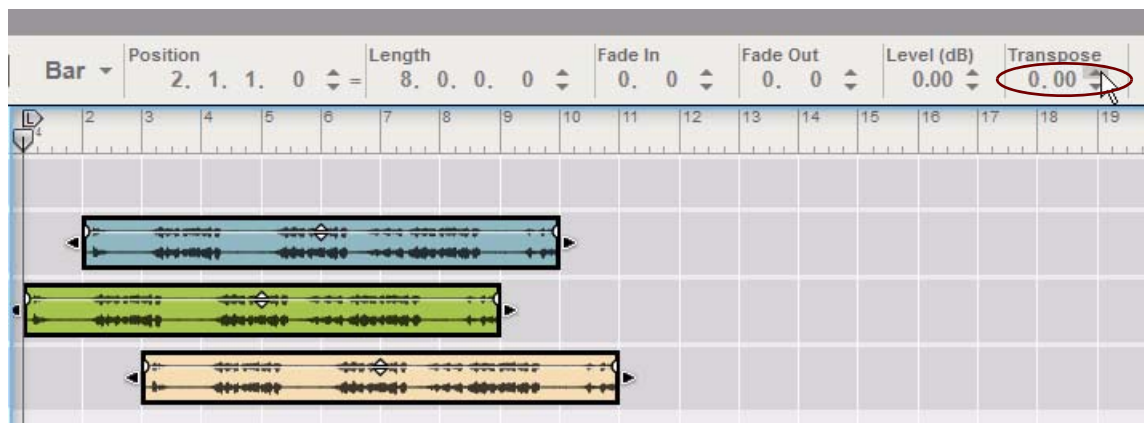

*Three audio clips selected on the arrangement pane in the Song View.*

## 2. Click the up/down arrow button next to the Transpose display to change the transposition in Semitones and Cents.

The audio in the selected clips are now transposed relative to their original pitch.

- **You can also edit the transposition value by clicking and dragging the respective display segment up/down or entering numeric values according to standard procedures.**
- **It's also possible to transpose individual Comp Rows in a Comp clip - see “[Transposing Comp Rows](#)” below.**
- **Audio Clips and MIDI notes in Note Clips can be transposed in whole semitone steps in the Transpose section in the Tool Window - see “[Pitch \(Transpose\)](#)”.**

## Transposing Comp Rows

Besides the Audio Clip Transpose function described above, individual Comp Rows in a Comp clip can be individually transposed:

1. Open a comped audio clip in the Comp Editor and select a Comp Row to be transposed.

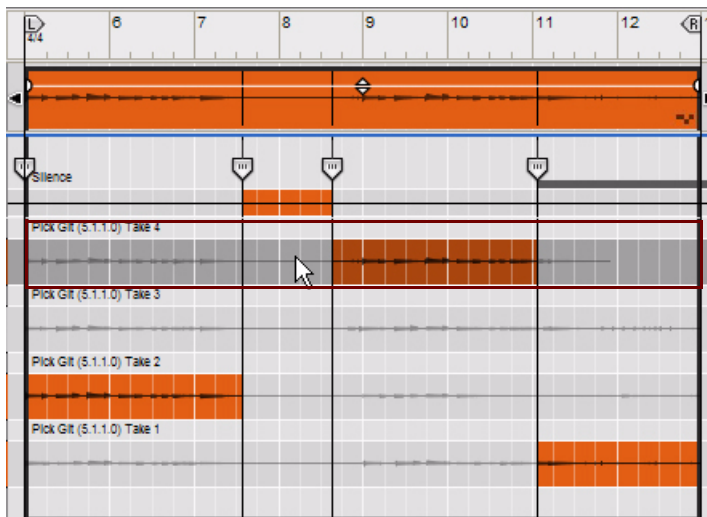

*The selected Comp Row is shown in a darker color.*

2. Change the Transpose value in the Inspector as desired.

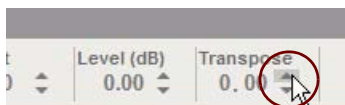

3. Select another Comp Row and change its Transpose value in the Inspector as desired.

Now the Comp Rows will have individual transposition values.

- If you decide to change the Transpose value for the entire audio clip - by selecting the clip in the Clip Overview - the relative transpositions of the Comp Rows will be preserved.

# Audio and tempo matching

## Matching an imported audio clip to the song tempo

Audio files created by the Export or Bounce functions in Reason include information about their original tempo. When you import such an audio file, it will automatically be stretched to fit the tempo in the new song.

However, if you have imported an audio clip which has a steady, but unknown, tempo, you can adjust the imported clip to the song tempo. You can either use the Clip Tempo Scaling function to manually “stretch” the audio clip as described in “Tempo scaling Clips”.

Another way is to disable the automatic stretch for the audio clip and then adjust the sequencer tempo to match the clip. This is done in two steps: first you adjust the song tempo to the imported audio clip without Stretch enabled and then adjust the song tempo back to original - with Stretch enabled on the audio clip:

1. **Select the clip containing the imported audio file and choose “Disable Stretch” from the Edit menu or context menu.**

Disabling Stretch makes the audio recording in the clip play back at the same tempo regardless of song tempo in the sequencer.

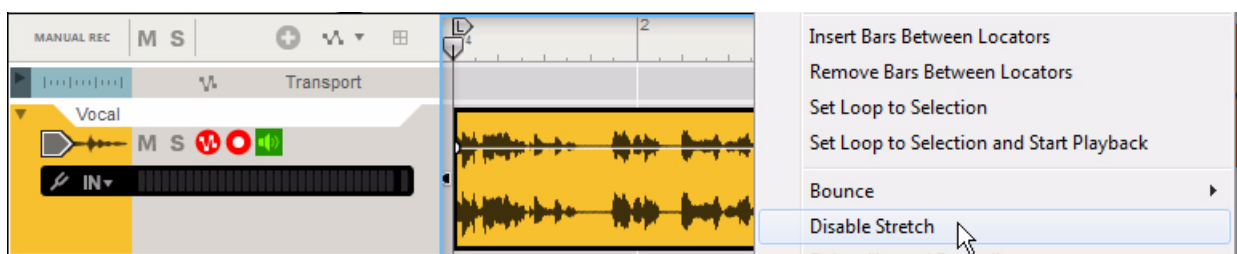

*Disabling Stretch on a clip containing an imported audio recording.*

2. **Start the sequencer and adjust the sequencer Tempo, up or down, to match the tempo of the audio recording in the clip.**

If necessary, enable the metronome click in the sequencer to get an audible tempo reference. Continue adjusting the tempo of the song until it matches the tempo of the audio recording.

3. **Adjust the length of the clip so that it plays the entire audio file (or as much as you want).**
4. **Select the clip and select "Bounce > Bounce Clip to New Recording" from the Edit menu or context menu.**  
The new recording will sound the same, but include information about the tempo you set in step 2.
5. **With the audio clip still selected, choose “Enable Stretch” from the Edit menu or context menu.**
6. **Adjust the song tempo back to the original BPM.**

As you adjust the song tempo, the tempo of the audio recording will follow along accordingly - without affecting the original pitch of the recording. This is done by stretching the audio. Reason does this automatically in two parallel steps: a real-time “preview” stretch so that you can instantly hear the result of your tempo changes, then a high quality stretch “in the background” to further improve the sonic results. As soon as high quality stretch is in progress, the “Calc” indicator on the Transport Panel shows a progress meter:



*The CALC progress meter appears when Reason performs high quality stretching of audio.*

Since the high quality stretch is performed in the background, you can still continue to work with your song without any interruption. When the high quality stretch data has been calculated, the Calc indicator goes out and the high quality audio data will be heard on playback.

# Editing audio using the Inspector

The Inspector can be used for editing audio recordings numerically.

## Editing recordings and cuts in the Inspector

If you select a Comp Row, the three displays change to show the Recording Offset, Comp Row Level and Comp Row Transpose value:

Recording Offset	Level (dB)	Transpose
0. 0. 0. 0. 0	0.00	0.00

If you select a Cut Handle in Comp Mode, two displays appear, showing the Cut Handle's Position and Crossfade time:

Cut Position	Cut Crossfade
8. 3. 3. 0. 0	6. 79. 4

- **Edit the values by clicking on a segment in a display and then dragging up/down, using the up/down spin controls, or typing in new values. Snap is not taken into account.**

See ["Inspector segment displays"](#) for details on how to edit in the Inspector displays.

## Editing multiple recordings or multiple cuts in the Inspector

When you edit values for several selected Comp Rows or objects (Cut Handles etc.), the changes will always be relative. For example, if you change the Recording Offset, Level or Transpose values when several Comp Rows are selected, the recordings will all be changed by the same amount; their relative values will be retained.

- **If several Comp Rows are selected, the displays will show the values for the topmost selected Comp Row.**
- **If several Cut Handles are selected, the displays will show the Position and Crossfade values for earliest Cut Handle in the clip.**
- **If several Comp Rows, or several Cut Handles, are selected and any of their values differ, Match Value buttons appear next to the corresponding display.**  
For Cut Handles, only Crossfade values can be matched - not the Positions. See ["Matching audio values using the Match Values" function](#).
- **If Comp Rows and Cut Handles are selected in combination (e.g. for moving Cuts and recordings together as a group), no displays are shown in the Inspector.**

## Matching audio values using the "Match Values" function

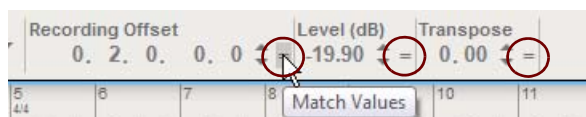

The Match Values buttons appear as '=' signs.

The "Match Values" function in the Inspector can be used for matching Recording Offsets, Comp Row Levels and Transpose values of several selected Comp Rows to the offset/level/value of the topmost selected Comp Row. It can also be used for matching Cut Crossfade values of several selected Cut Handles to the Crossfade value of the Cut Handle with the earliest start position in the clip.

## Matching Recording Offsets

Matching Recording Offsets is useful if you want to make sure that the Recordings on multiple Comp Rows start at the exact same position.

1. **Select more than one Comp Row and then place the Selection Tool on the Recording Offset Match Value button.**

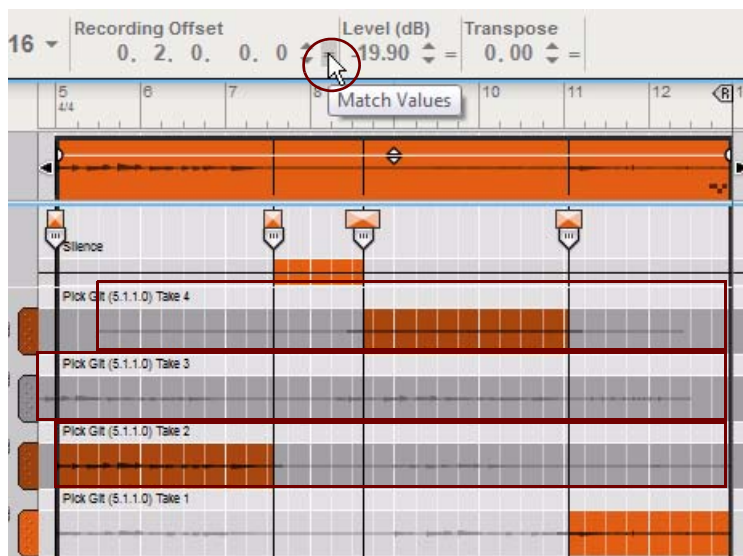

*Three selected Comp Rows (the three topmost).*

The topmost Comp Row has the Recording Offset set to 2 beats.

2. **Click the Match Value button to the right of the “Recording Offset” display.**

The Recording Offsets on all selected Comp Rows have now been moved to 2 beats.

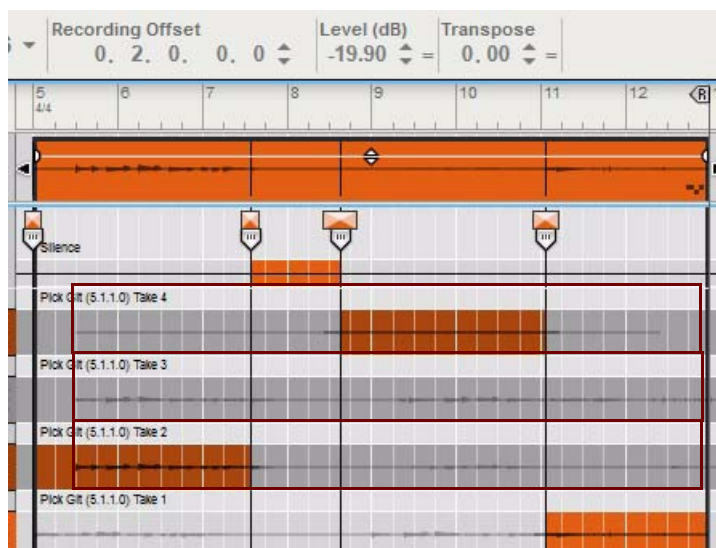

*The Recording Offsets of the recordings on the three topmost Comp Rows have been moved to 2 beats.*

## Matching Comp Row Levels

Here's an example showing how to match Comp Row Levels:

- **Select several Comp Rows and then click the Level Match Value button.**

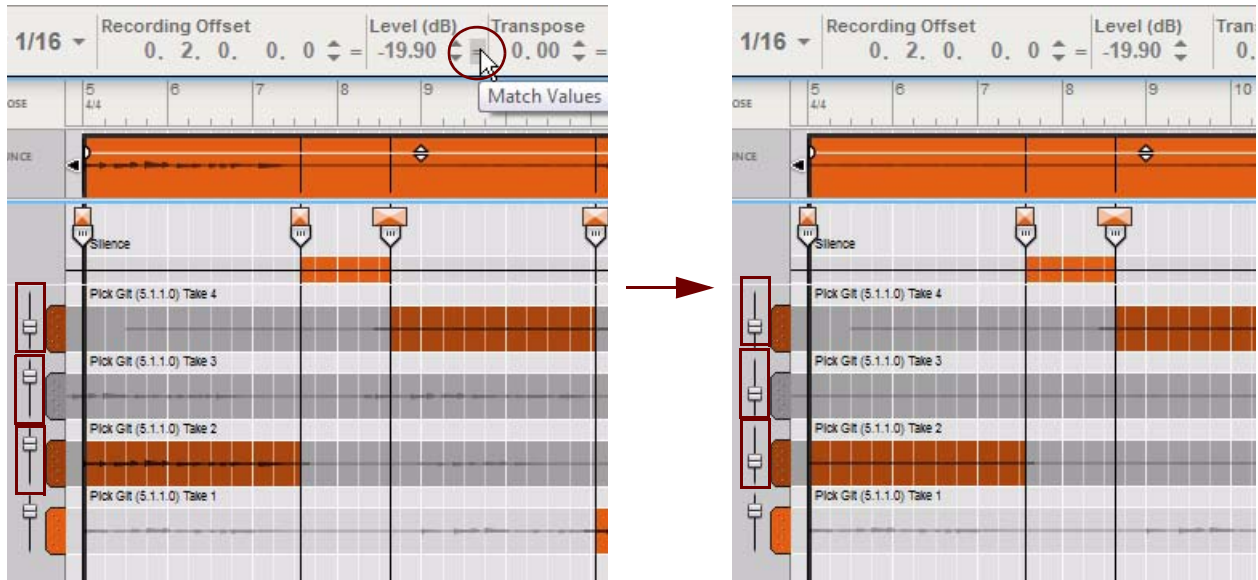

*The Levels on the three selected Comp Rows are matched and adjusted to -19.90 dB.*

## Matching Comp Row Transpose values

- **Select several Comp Rows and then click the Transpose Match Value button.**

The transposition is matched to the Transpose value of the topmost selected Comp Row.

## Matching Cut Crossfades

Matching Cut Crossfades is a time-saving function if you want to apply the same Crossfade times to several Cuts throughout the clip. If you want to eliminate any clicks between segments in your comped clip, you could apply a Cut Crossfade to the first Cut and then match the other Cuts to get the same Crossfade times in one go:

- **Select several Cut Handles and click the Cut Crossfade Match Value button.**

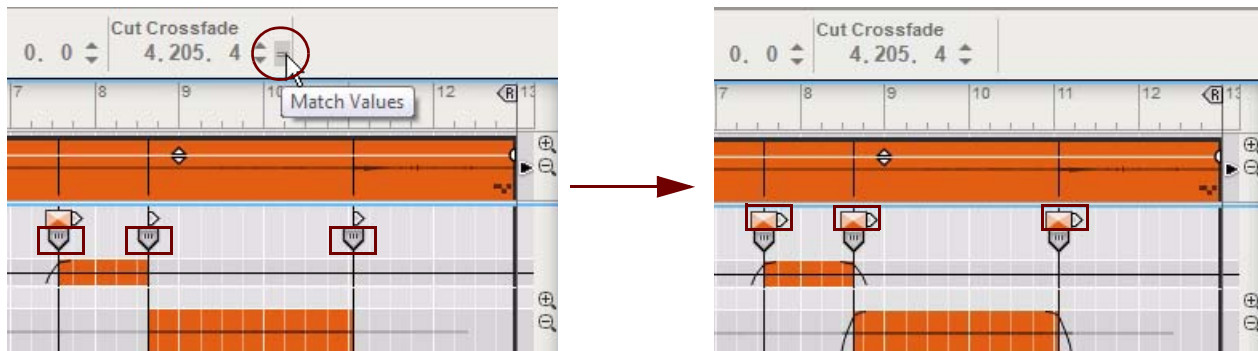

*The Crossfades of the selected Cuts are matched and adjusted to the Crossfade times of the earliest selected Cut.*

# **Chapter 9**

## **Note and Automation**

### **Editing**

# About this chapter

This chapter describes how to edit note and parameter automation events after they have been recorded in the sequencer. It also describes how to manually create note and automation events in clips. General sequencer functions, recording, editing audio, arranging in the sequencer and working with Blocks are described in detail in the chapters “Sequencer Functions”, “Recording in the Sequencer”, “Audio Editing in the Sequencer”, “Arranging in the Sequencer” and “Working with Blocks in the Sequencer”.

## The Edit Mode

After you have recorded in note clips or parameter automation clips, you might want to edit and correct any mistakes you made during the recording. For example, if you accidentally hit the wrong key or used the Mod Wheel too extensively when you recorded a note clip, there is no need to redo the recording. Individual notes and parameter automation events can easily be edited and corrected in a number of different ways.

Edit Mode in the sequencer is where you can perform detailed editing of note and automation events.

- **To enter Edit Mode, either double-click a note clip in the Song/Block View or select the clip and hold down [Ctrl](Win) or [Cmd](Mac) and press [E].**

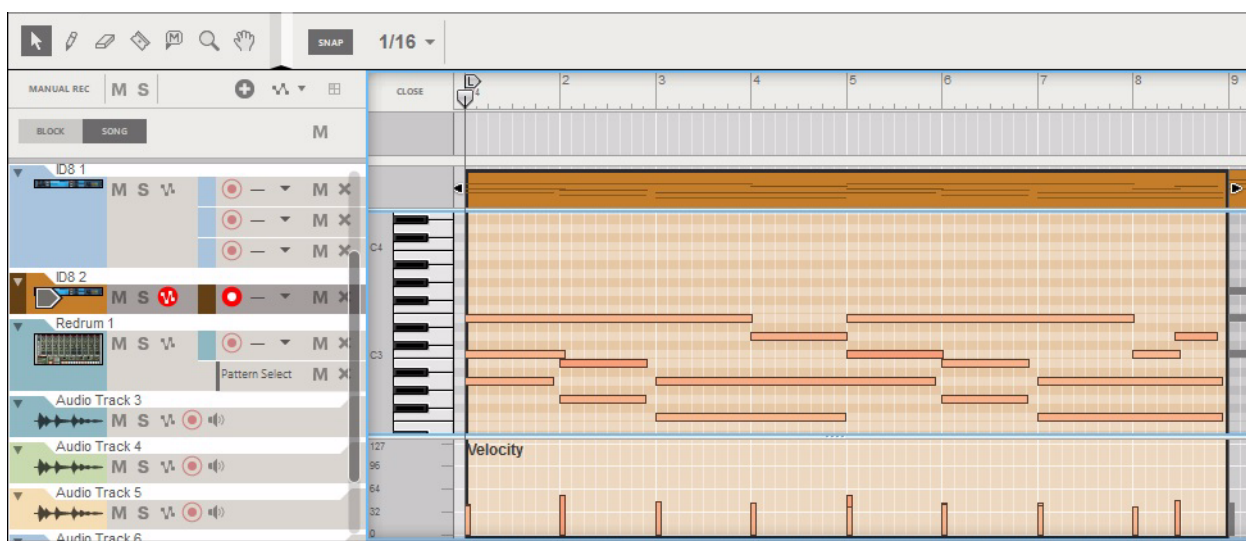

*Double-clicking a note clip in the Song/Block View opens it for editing in Edit Mode.*

- **Exit Edit Mode by clicking the Close button, or by holding [Ctrl](Win) or [Cmd](Mac) and pressing [E].**

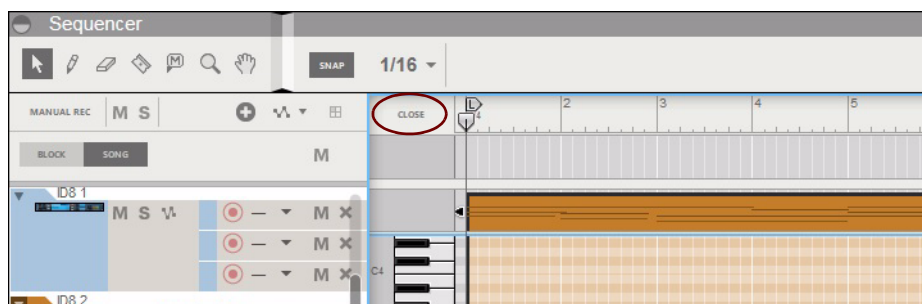

*Click the Close button to close the clip and revert to the Song/Blocks View.*

- **Toggle between the Song/Block View and Edit Mode by pressing [Shift]+[Tab] or by holding [Ctrl](Win) or [Cmd](Mac) and pressing [E].**



## Selecting what to edit

The Edit Mode shows the contents of a single track at a time on the Edit Pane. On instrument tracks, only one note lane can have edit focus at a time.

- **If a track is selected when you enter Edit Mode, the contents of the note lane with edit focus will be shown.**  
Also, all parameter automation lanes will be shown at the bottom of the Edit Pane. If a single clip was selected on the note lane with edit focus when you switched to Edit Mode, it will automatically be opened. If no clip was selected, the events will be grayed out. To be able to edit or draw notes and/or automation events, you need to open the clip, for example by double-clicking it (see [“Opening note and automation clips for editing”](#)).
- **If the selected track has multiple note lanes, the contents of the currently selected note lane will be shown.**  
To switch edit focus between note lanes, click on the note lane handle in the Track List.

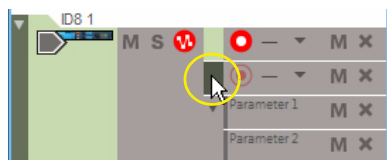

*A note lane handle.*

- **You can change track and note lane edit focus at any time, by clicking in the Track List.**  
This way you can stay in Edit Mode and change edit focus between different tracks and note lanes, without having to go back to the Song/Block View.

## Opening note and automation clips for editing

### Open a note clip for editing

Note clips can contain both note events - with velocity values - and performance controller events. By default, performance controllers include Mod Wheel, Pitch Bend, Sustain Pedal, Aftertouch, Expression and Breath Controller. However, the controller configuration can easily be changed (see [“Creating new performance controller automation lanes”](#) and [“Deleting performance controller automation lanes”](#)).

In the Song/Block View, note events are displayed in a “piano roll” fashion whereas performance controllers are displayed as curves or lines in the clip. In the Song/Block View, it’s not possible to distinguish one performance controller from another since all controllers are displayed together in the clip. The note clip in the picture below contains note events and Mod Wheel and Pitch Bend performance controller events:

- **To edit the events in a note clip, open the clip by double-clicking it, or select it and press [Return].**  
Opening a note clip in the Song/Block View automatically switches the sequencer to Edit Mode.

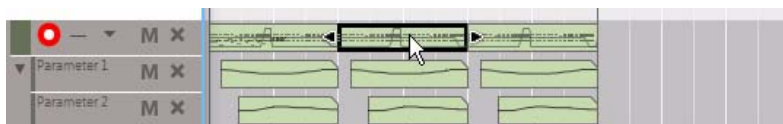

*Double-clicking a note clip in the Song/Block View...*

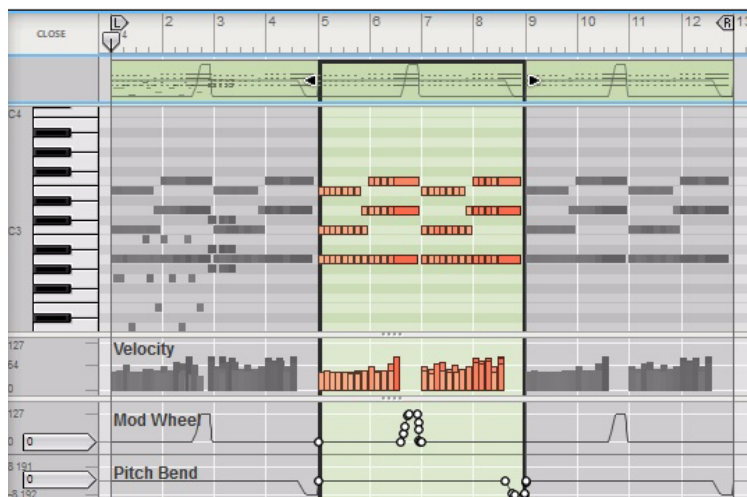

*...opens it for editing in Edit Mode. An open clip in Edit Mode is highlighted.*

- **Double-click on a closed (grayed out events) note clip in Edit Mode to open it for editing in Edit Mode.**  
You can double-click in the Clip Overview, Note Edit Lane or any of the Performance Controller Edit Lanes (if any).
- **To close a clip, press [Esc], click outside the open clip in the Clip Overview, or click the Close button.**  
If you opened the clip from the Song/Block View, pressing [Esc] will automatically switch the sequencer back to the Song/Block View.

## Open a parameter automation clip for editing

A parameter automation clip contains automation events for a single parameter.

- **Double-click a parameter automation clip in the Song/Block View to open it for editing in the Song/Block View.**  
The parameter automation lane expands in height to make it easier to edit the automation events. Now you can edit the parameter automation events without needing to switch to Edit Mode. This is very practical if you want to perform quick editing of automation events.

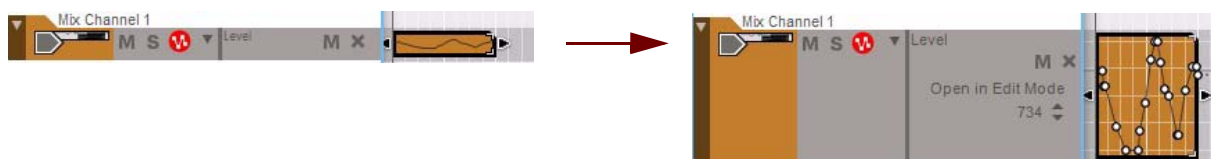

*A parameter automation clip before and after opening it in the Song/Block View.*

- **To close an open parameter automation clip in the Song/Block View, press [Esc] or click on another lane.**  
See [“Editing parameter automation in the Song/Block View”](#) for information on how to edit parameter automation events in the Song/Block View.
- **To open a parameter automation clip in the Song/Block View for editing in Edit Mode, double-click the clip and then click the Open In Edit Mode button.**

→ Double-click on a parameter automation clip in Edit Mode to open it for editing in Edit Mode.

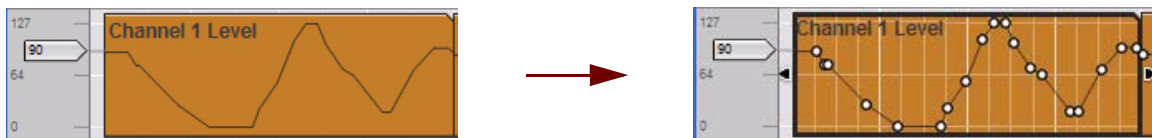

A parameter automation clip before and after opening it in Edit Mode.

→ To close an open parameter automation clip in Edit Mode, press [Esc] or click anywhere on another lane.

See "Editing parameter automation in Edit Mode" for information on how to edit parameter automation events in Edit Mode.

## Edit Mode elements

In Edit Mode, a note clip is divided into various Edit Lanes which are used for editing different types of events and values (i.e. note events, velocity values and performance controller automation events). At the bottom, any parameter automation lanes on the track will also be shown. The different Edit Lanes can be resized by adjusting the horizontal dividers between the lanes. You can also scroll and zoom on each Edit Lane by using the scroll bars and Vertical Zoom tools on the right hand side of the Edit Pane.

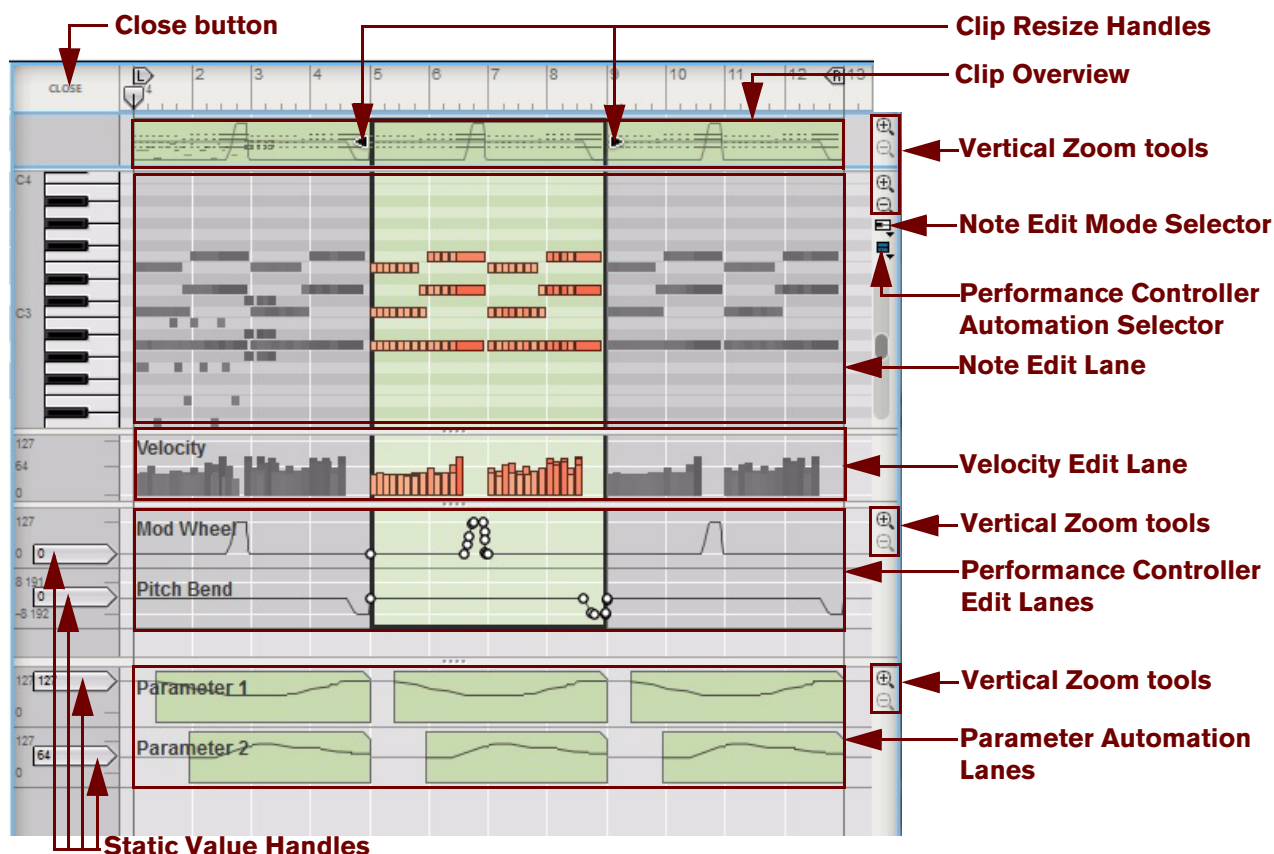

The picture shows three note clips in Edit Mode. The center clip is open for editing and therefore highlighted. Adjacent (closed) clips on the same lane are visible but the events are grayed out.

From the top down in the picture above, the Edit Pane contains the following elements:

- **Close button**  
Click the Close button to exit Edit Mode and return to the Song/Block View.
- **Clip Resize Handles**  
By clicking and dragging either of the handles, you can change the position and length of the clip.
- **Clip Overview**  
The Clip Overview shows the note clips of the note lane which has edit focus. You can select one or several clips in the Clip Overview and perform clip-based editing (e.g. moving and resizing) - just like in Arrange Mode.
- **Note Edit Mode Selector**  
To the right of the Note Edit Lane, below the Vertical Zoom tools, is the Note Edit Mode Selector. Click to choose between Key Edit, Drum Edit or REX Edit Mode. Depending on selected mode, the Note Edit Lane will display differently. See more about the different modes in [“Note Edit Modes”](#).
- **Performance Controller Automation Selector**  
Each performance controller you used when recording the note clip has its own separate Performance Controller Edit Lane. You can add or delete performance controller edit lanes from the clip using this selector. See the [“Creating new performance controller automation lanes”](#) and [“Deleting performance controller automation lanes”](#) for more details.
- **Note Edit Lane**  
Here you can edit the notes of one open clip at a time. Note events are displayed as orange horizontal “boxes” in a piano roll fashion on the Note Edit Lane. The left side of each box indicates Note On (key down) and the right side Note Off (key up). The color intensity of each box indicates the velocity for the corresponding note. Depending on selected Note Edit Mode (see [“Note Edit Modes”](#)), the contents of the Note Edit Lane will display differently.
- **Velocity Edit Lane**  
The Velocity Edit Lane shows the velocity values for each of the recorded notes. Velocity values are automatically recorded together with notes. See more about editing velocity values in [“Editing note velocity”](#).
- **Performance Controller Edit Lanes**  
On the Performance Controller Edit Lanes are the performance controller events for Mod Wheel, Pitch Bend, Sustain Pedal etc. Performance controller events are automatically distributed on separate lanes for each recognized controller during recording. Even though performance controllers belong to separate note clips, they will affect *all* active parallel note lanes on a track. See [“Automation editing”](#) for details on how to edit performance controller events.
- **Parameter Automation Lanes**  
Any recorded parameter automation will be shown in separate clips, on separate Parameter Automation Lanes. Parameter automation clips don’t “belong” to the note lane or to any note clips, and will not be opened together with note clips. Double-clicking on a parameter automation clip will open it for editing. See [“Automation editing”](#).
- **Static Value Handles**  
The Static Value Handles to the left of the Performance Controller Edit Lanes and Parameter Automation Lanes indicate to what value the automated controller/parameter will default to where there are no clips on the lane. Basically, this value reflects the parameter’s initial value, before it was automated. You can easily change a parameter’s Static Value by dragging the Static Value Handle up or down. See [“Automation editing”](#) for more details.

# Edit Mode window handling

## Resizing, zooming and scrolling

→ You can resize or hide Edit Lanes by dragging the dividers between them.

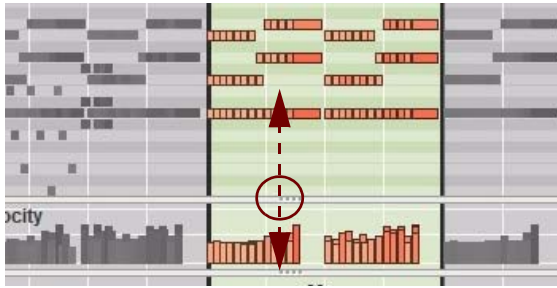

Where applicable, individual zoom controls and scrollbars are available to the right of each Edit Lane.

- The Magnifying Glass tool can be used for zooming in and out (see “Magnifying Glass Tool”).
- The Hand tool can be used for scrolling the view in any direction (see “Hand Tool”).
- Use the Song Navigator to scroll and zoom horizontally (see “Areas, windows and basic navigation”).
- Click on a Song Navigator Handle and drag horizontally to zoom in and out horizontally (see “Areas, windows and basic navigation”).
- Shift-click on a Song Navigator Handle and drag horizontally to zoom in and out horizontally, symmetrically (see “Areas, windows and basic navigation”).
- Shift-click or Right-click (Win) or Ctrl-click (Mac) inside the Song Navigator and drag up or down to zoom in and out horizontally, symmetrically (see “Areas, windows and basic navigation”).
- Use the Scrollbars to scroll vertically in the respective Edit Lanes.
- Click the Zoom buttons to the right to zoom in and out vertically in the respective Edit Lanes.
- For extensive editing, you may want to maximize the sequencer and/or have it in a separate window covering the entire computer screen. Refer to “Areas, windows and basic navigation”.

## Note Edit Modes

When you switch to Edit Mode, the device used on the selected instrument track determines which Note Edit Mode is selected. For instrument tracks associated with synth devices such as the ID 8 device, for example, Key Edit Mode is automatically selected. For Redrum tracks Drum Edit Mode is selected and for Dr. Octo Rex tracks the REX Edit Mode is automatically selected.

In all three Note Edit Modes, the note events are shown as “boxes”, with the note length indicated by the width of the box and the velocity values indicated by the color intensity of the box (the darker the color, the higher the velocity). The basic note editing procedures are the same for all three Note Edit Modes.

- You can manually change Note Edit Mode by clicking the Note Edit Mode button in the upper right corner of the Note Edit Lane and selecting another mode from the pop-up menu.

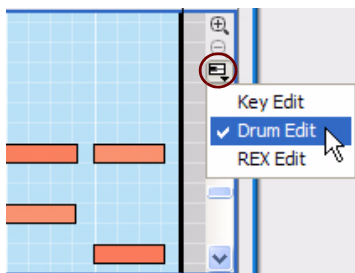

*Selecting Note Edit Mode.*

The selected Note Edit Mode is automatically remembered for each note lane on a track. The next time you switch to Edit Mode, the correct Note Edit Mode will be recalled for that note lane.

## Key Edit Mode

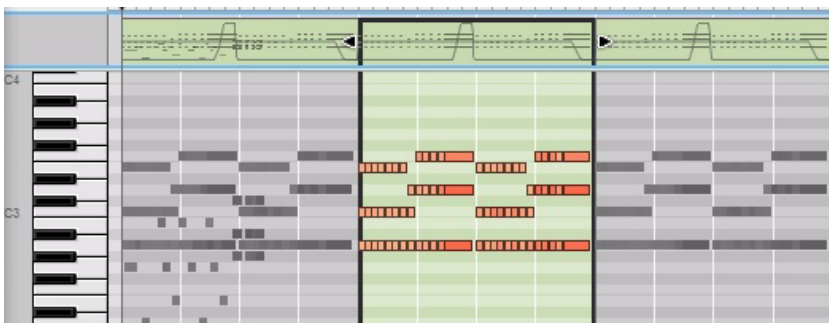

*Key Edit Mode.*

Key Edit Mode is best suited for viewing and editing notes recorded for instrument devices, such as the ID 8. The piano keyboard to the left indicates the notes values, covering the entire MIDI note range (C-2 to G8). By clicking on any of the keys, you can audition the notes. As soon as the mouse pointer reaches the keyboard section, the cursor changes to a speaker symbol.

- Note that the black and white keys are reflected in the background colors of the Note Edit Lane grid, making it easier to locate the desired note when drawing and moving note events.

## Drum Edit Mode

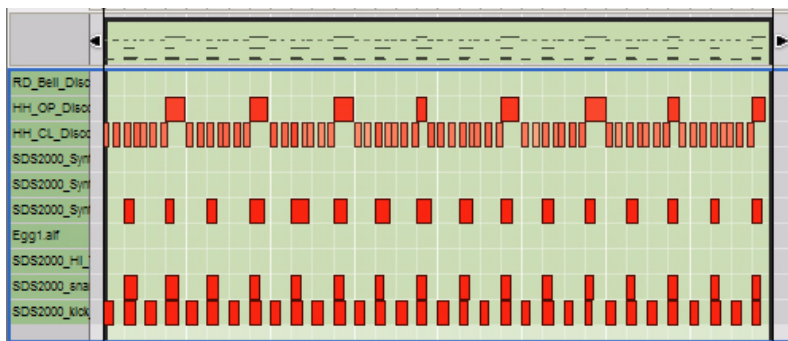

*Drum Edit Mode.*

Drum Edit Mode is best suited for viewing and editing notes recorded for a Redrum device. In Drum Edit Mode the keyboard has been replaced by a list showing the corresponding Redrum drum sound channel names. If the track is associated with another type of instrument device, the list shows MIDI note numbers (0-127) instead. By clicking on any of the names (or note numbers) in the list, you can audition the sounds.

## REX Edit Mode

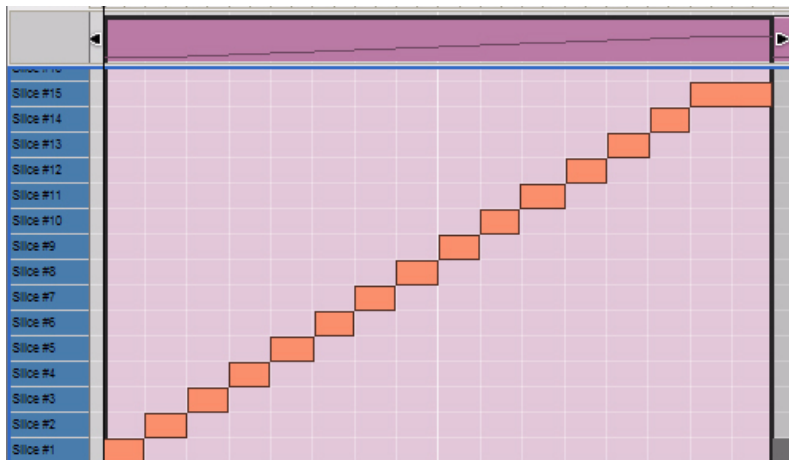

*REX Edit Mode.*

REX Edit Mode is designed for viewing and editing Dr. Octo Rex Loop Player slices. In REX Edit Mode the keyboard has been replaced by a list showing the corresponding loop slice numbers in a Dr. Octo Rex device. Slice #1 in the list corresponds to the note C3. By clicking on any of the slice numbers in the list, you can audition the corresponding sound of the Rex loop.

## Creating empty clips

When you record in the sequencer, clips are automatically created on the record enabled lane when necessary. However, there might be situations when you want to manually draw empty clips in the Song/Block View to record or edit in later on:

→ **To create an empty clip, double click with the Selection (Arrow) Tool on a track.**

This will create an empty clip with the length of the current Snap value setting (e.g. 1 bar). To create longer clips, double click, keep the mouse button pressed and drag to the right.

Alternatively, do as follows:

**1. Select the Pencil Tool from the sequencer Toolbar.**



**2. Place the Pencil on the lane where you want the clip to begin.**

If you want to create a note clip, draw it on a note lane. If you want to create a parameter automation clip, draw it on a parameter automation lane. If Snap is activated, the clip start and end boundaries will snap to the set Snap value (see "Snap").

**3. Click and drag the Pencil to the right where you want the clip to end.**



*An empty note clip in the Song View created using the Pencil Tool.*

→ **You can also draw empty clips in Edit Mode. A note clip should then be drawn in the Clip Overview and a parameter automation clip on the corresponding Parameter Automation Lane.**

If you draw on the Edit Pane in Edit Mode, a note will be created instead. If necessary, a new clip will be automatically created to surround the note.

→ See also **"Drawing notes"** and **"Drawing parameter automation events"**.



# Tool Window editing tools

The Sequencer Tools tab in the Tool Window is very useful when you want to perform various note and parameter automation editing tasks. Here is how you access the Tool Window and the contents of the Sequencer Tools tab:

- 1. Open the Tool Window by selecting “Show Tool Window” from the Window menu. Alternatively, press [F8].**  
The [F8] key can be used for toggling between showing and hiding the Tool Window.
- 2. Click the Sequencer Tools tab.**

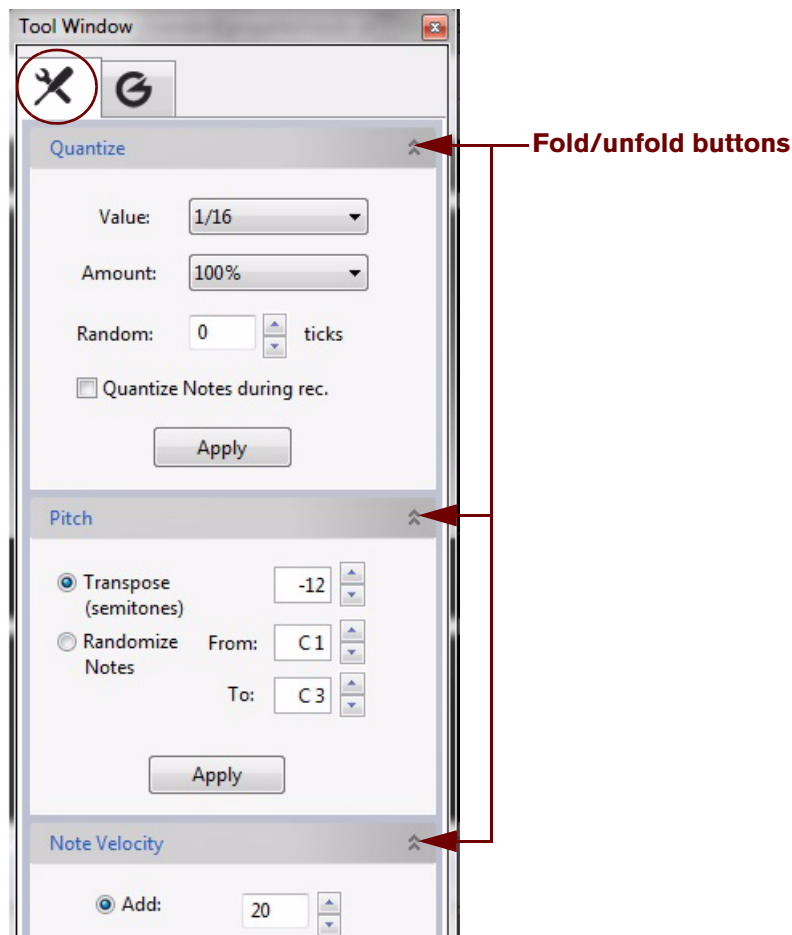

*The Sequencer Tools page has a number of panes, each with separate functions.*

- **Click on the arrow buttons to the right of the function name to fold/unfold the corresponding pane.**
- **Hold down [Alt](Win) or [Option](Mac) and click an arrow button to fold/unfold all panes simultaneously.**

The values in the displays on the various panes can be edited in similar ways as in the Inspector. For single-segment displays, you can either use the spin controls or click in the display and select a value from a list, or drag up or down to change the value. For multi-segment displays, click on a specific segment (e.g. bars, beats, 1/16ths or ticks) and then use the spin controls to set the value. Alternatively, click on a segment and drag up or down.

# Note editing

Notes can be edited using the mouse in Edit Mode. It's also possible to edit notes by using the functions on the Tools tab in the Tool Window. Notes can also be numerically edited in the Inspector, as described in [“Note and automation editing in the Inspector”](#).

## Selecting notes

To select notes in an open clip in Edit Mode, use one of the following methods:

- **Click on a note event with the Selection (Arrow) Tool.**



*The Selection tool.*

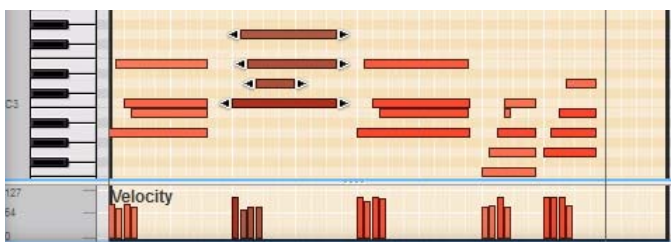

*Selected notes are distinguished by a darker color and by the handles at both edges.*

- **To select several notes, hold down [Ctrl](Win) or [Shift](Mac) and click on the desired notes, one after the other. You can de-select individual notes by [Ctrl](Win)-clicking or [Shift](Mac)-clicking them again. In Windows it's also possible to select a range of notes by [Shift]-clicking the first and last note in the range.**
- **You can also click and drag a selection rectangle around the notes you want to select.**
- **You can select the next or previous note on the lane by pressing the right or left arrow key on the computer keyboard.**  
Holding down [Shift] and using the arrow keys allows you to make multiple selections.
- **To select all notes of the same pitch (note value) in a clip, first select one or several notes and then use the function "Select Notes of Same Pitch" on the Edit menu or context menu.**
- **To select all notes in the open clip, use the "Select All" function on the Edit menu. Alternatively, hold down [Ctrl](Win) or [Cmd](Mac) and press [A].**
- **To deselect all notes, click somewhere in an empty area in the clip (where there are no events).**

# Drawing notes

Notes are usually drawn and edited in Key Edit Mode on the Note Edit Lane, but the actions described below also apply to the Drum Edit Mode and the REX Edit Mode.

! **If you want to restrict note input to certain note values (e.g. 1/16th notes), activate Snap (see “Snap”) and set the snap value accordingly.**

→ **Double click with the Selection (Arrow) tool in the open clip to insert a note with a length of the current Snap value.**

This will create a note with the length of the current Snap value setting (e.g. 1/16th note). To create longer notes, double click, keep the mouse button pressed and drag to the right.

Alternatively, do as follows:

1. **Select the Pencil tool.**



→ **With the Selection (Arrow) tool selected, you can toggle temporarily between the Selection tool and the Pencil tool by holding down [Alt](Win) or [Cmd](Mac).**

2. **Click at the desired position on the Note Edit Lane.**

A note will be inserted at the closest Snap value position. By default, the note will be given the Velocity value '100'. (This can be edited afterwards according to the descriptions in “Editing note velocity”). If an open or closed clip is already present on the Note Lane, at the position where you draw the note, the note will be placed in that clip. If no clip is available, refer to “About drawing notes outside an open clip” and “About drawing notes outside a closed clip” below.

• **If you just click, and Snap is activated, the note will get the length of the set Snap value.**

If Snap is off, the note will get the length of the shortest possible Snap value, i.e. 1/64th note.

• **If you click and keep the mouse button depressed, you can drag to the right to set the length of the note.**

If Snap is on, the length will be a multiple of the Snap value.

! **If you are drawing drum notes for a Redrum device, refer to the info about drum note lengths in “About resizing drum notes”.**

## About drawing notes outside an open clip

If you draw notes outside the boundaries of an open clip, the result depends on the setting "Keep Events in Clip While Editing" on the Options menu:

- If the "Keep Events in Clip While Editing" option is active, the notes will belong to the open clip after they have been drawn, but become masked since they are drawn outside the clip boundaries. The clip position and length will remain unchanged.
- If "Keep Events in Clip While Editing" is deactivated and you draw notes outside the clip, the notes will be placed in an existing clip - or in another new clip on the lane, depending on where you draw. The picture below shows three scenarios when drawing a note outside an open clip with the "Keep Events in Clip While Editing" option off:

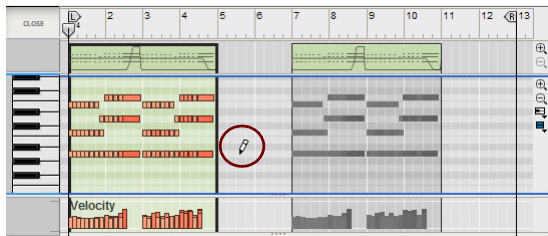

Here, we're going to draw a note in beat 3 of bar 5...

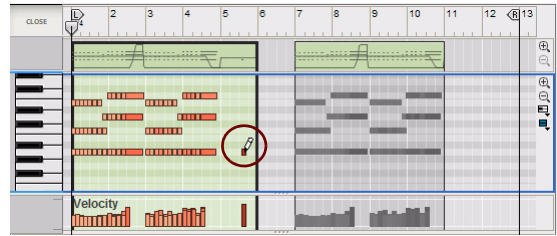

The open clip expands by the set Arrange Mode Snap value (1 bar) to fit in the new note.

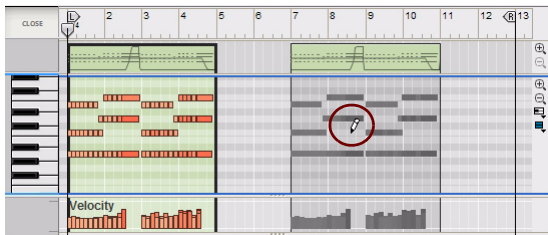

Here, we're going to draw a note in beat 3 of bar 8...

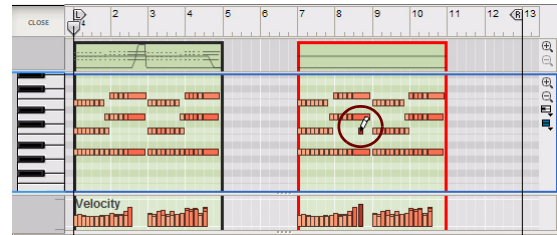

The note is placed in the existing clip at beat 3 of bar 8.

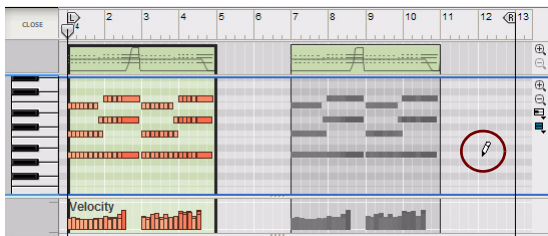

Here, we're going to draw a note in beat 1 of bar 12...

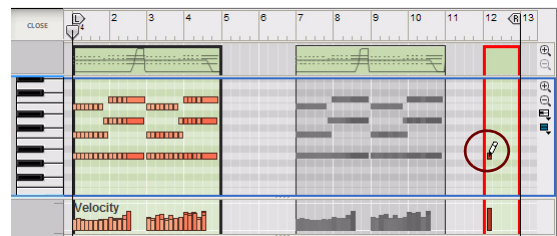

A new clip is created at bar 12 with a length of the set Snap value (1 bar) and the new note is placed in beat 1.

## About drawing notes outside a closed clip

If you draw notes outside the boundaries of a closed clip in Edit Mode, i.e. where there are no clips available on the lane, a new clip will be automatically created and opened. The clip length is determined by the Song/Block View Snap value, if Snap is activated.

- This works best with "Keep Events in Clip while Editing" turned OFF because then you can continue drawing notes - the clip will be resized to fit the new notes.

## Deleting notes

You can delete notes by doing any of the following:

- To delete individual notes, double click the note with the Selection (Arrow) tool.
- Select one or several notes with the Selection (Arrow) tool and press [Backspace] or [Delete], or select “Delete” from the Edit or context menu.
- Select the Eraser tool and click on the notes you want to delete.

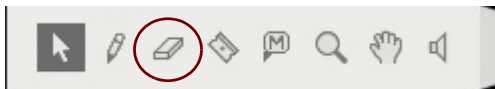

*The Eraser tool.*

- You can also draw a selection rectangle with the Eraser tool to delete several notes in one go.

## Resizing notes

### Resizing notes manually

When you select a note on the Edit Pane, a handle appears on either edge of the note. You can click any of these handles and drag sideways to make the note shorter or longer.



- If Snap is on (see “Snap”), the beginning and/or end of the note will be magnetic to the (absolute) Snap value positions.
- If several notes are selected, the note you resize with the mouse will be magnetic to absolute Snap value positions. The other selected notes will be resized by the current Snap value relative to their original positions or lengths.
- When resizing notes, the event may extend outside the clip boundaries.  
As long as the start position of events is inside the clip, the note will play for the whole duration, i.e. it won't be cut off when the clip ends.
- ! If a note is resized to the left, outside the clip start position, the note will no longer belong to that clip and will thus be masked (silent). To unmask the note, resize the clip to the left so that the note's start position gets inside the clip.

### About resizing drum notes

Redrum drum notes can be resized, just like any other notes. However, the audible result of this depends on the settings of the Decay/Gate switch and the Length knob for the drum sound on the Redrum device panel:

- If Decay mode is selected, the drum sound will play to its end, regardless of the note length in the sequencer. Or rather, it will fade out according to the Length parameter setting on the Redrum device panel.
- If Gate mode is selected, the note lengths in the sequencer affect the resulting sound.  
However, the maximum length of the sound is determined by the Length knob setting - the sound will be cut off after this length, regardless of the note length in the sequencer. Also, even if the Length knob is set to its maximum value, the sound will not play longer than the length of the drum sample.

## Resizing notes with the “Note Lengths” function

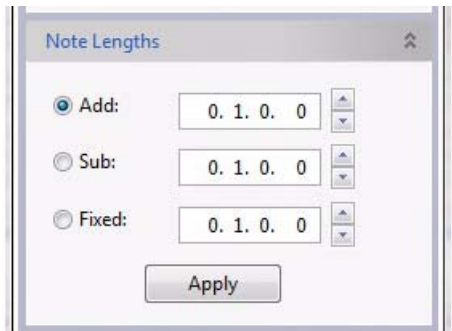

*The Note Lengths pane in the Tool Window.*

The “Note Lengths” function on the Sequencer Tools tab in the Tool Window allows you to add or subtract length values to the selected notes.

Note length resizing can be applied to:

- **Individual (selected) note events in a note clip.**  
This has to be done in Edit Mode.
  - **All note events in one or several selected note clips.**  
This is done in Arrange Mode. If the clips are on the same lane, it can also be done in Edit Mode.
  - ! **In Edit Mode, select clip(s) by clicking on it/them in the Clip Overview.**
  - **All note events in all note clips on one or several selected instrument tracks.**  
This has to be done in the Song/Block View.
- **Click the “Add” or “Sub” radio button and select the length value to add or subtract in the corresponding display. Then, click “Apply”.**
- **Click the “Fixed” radio button to set all notes to the length defined in the display. Then, click “Apply”.**

## Resizing notes with the “Legato Adjustments” function



*The Legato Adjustments pane in the Tool Window.*

The “Legato Adjustments” function can be used to extend each selected note so that it reaches the start position of the next selected note. You can also shorten the note length for the first of two selected overlapping notes and set a gap between them. You specify the desired gap or overlap in the displays. Only the note length is affected by Legato Adjustments - note start positions are never changed.

Legato adjustments can be applied to:

- **Individual (selected) note events in a note clip.**  
This has to be done in Edit Mode.

- **All note events in one or several selected note clips.**  
This is done in the Song/Block View. If the clips are on the same lane, it can also be done in Edit Mode.
- ! **In Edit Mode, select clip(s) by clicking on it/them in the Clip Overview.**
- **All note events in all note clips on one or several selected instrument tracks.**  
This has to be done in the Song/Block View.
- **“Side By Side (Abut)” extends the selected note(s) to the start of the next selected note(s):**

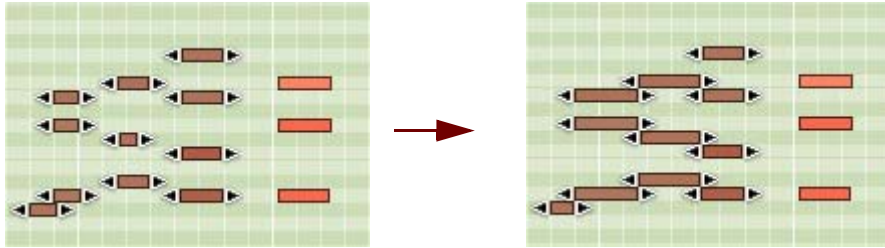

*A group of notes before and after applying the “Side By Side (Abut)” legato function.*

- **“Overlap” extends the selected note(s) to overlap the next selected note(s) by a set amount.**

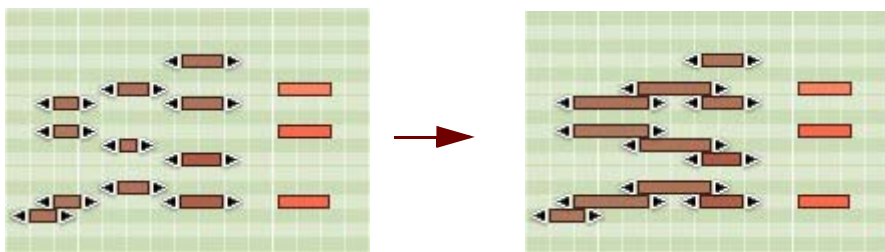

*A group of notes before and after applying the “Overlap” legato function with an overlap of 1/16th note.*

- **“Gap by” introduces a gap between selected notes, which you specify in the “Gap by:” display.**

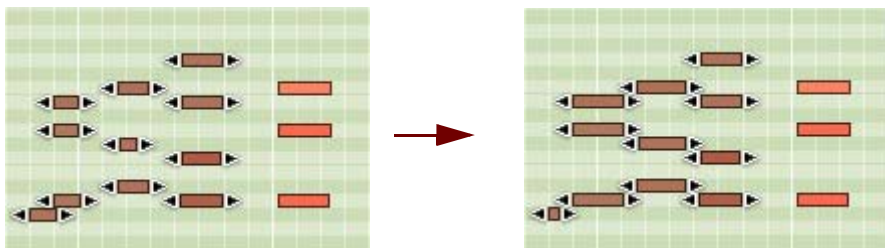

*A group of notes before and after applying the “Gap” legato function with a gap value of 1/16th note.*

## Resizing notes in the Inspector

You can also edit the length of notes numerically in the inspector. See [“Note and automation editing in the Inspector”](#).

# Moving notes

## Moving notes manually

- **To move a note, click and drag it to a new position, or new pitch (note number), using the Selection Tool.**

If several notes are selected, all will be moved. If Snap is on (see “Snap”), the moved events will keep their relative distance to the Snap value positions. For example, if the Snap value is set to “Bar”, you can move the selected notes to another bar without affecting their relative timing.

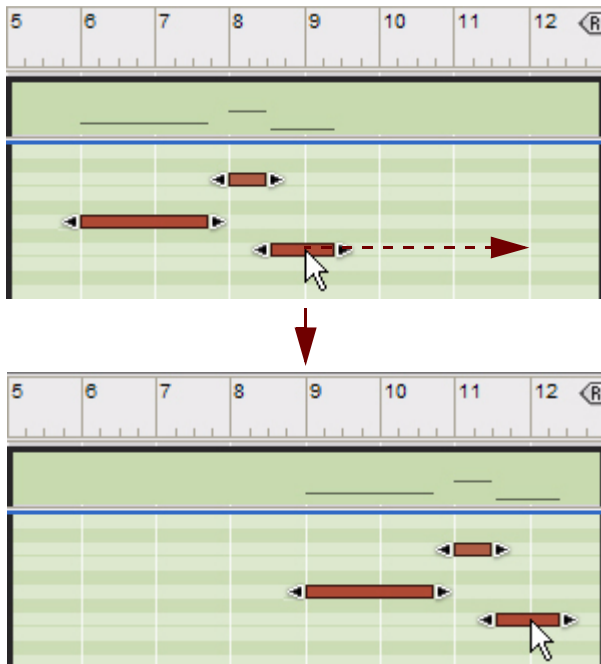

- **By default, when manually moving notes to new pitches (note numbers), the notes will trigger and sound. This makes it easier to move (transpose) the notes to where you want them.**

If you don't want notes to sound during editing, it's possible to disable the function in the Preferences dialog by de-selecting the “Trigger Notes While Editing” box:

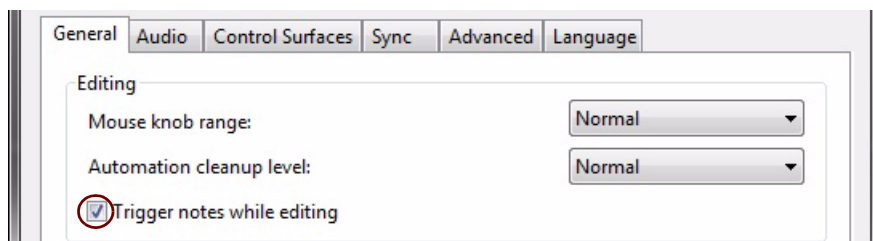

*The “Trigger notes while editing” function in the Preferences dialog.*

- **If you hold down [Shift] when you drag, the movement is restricted to horizontal or vertical direction.** This helps you move notes without accidentally transposing them, or transpose notes without accidentally changing their position.
- **You can also edit the note pitches numerically using the “Pitch (Transpose)” function in the Tool Window.** See “Pitch (Transpose)”.
- **You can also move selected notes to a new note clip, on a new additional note lane, by right-clicking (Win) or [Ctrl]-clicking (Mac) and selecting “Move Selected Notes to New Lane” from the context menu.** A new note clip and note lane will be automatically created.



## About moving notes outside or between clips

If you want to move notes outside the boundaries of an open clip, the result depends on the setting "Keep Events in Clip While Editing" on the Options menu:

- If the **"Keep Events in Clip While Editing"** option is active, the notes will belong to the open clip after they have been moved, but become masked since they are moved outside the clip boundaries. The clip position and length will remain unchanged.
- If **"Keep Events in Clip While Editing"** is deactivated and you move notes outside the clip, the notes will be placed in an existing clip - or in a new clip on the lane, depending on to where you move them to. The picture below shows three scenarios when moving three notes outside a clip with the "Keep Events in Clip While Editing" option off:

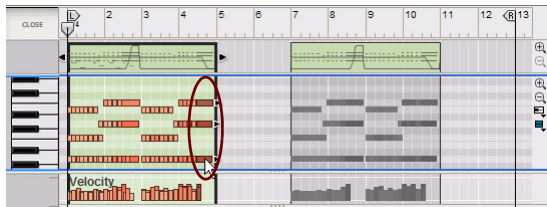

We're going to move the last three notes in the clip to beat 3 in bar 5.

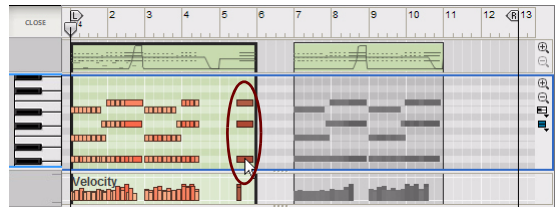

The open clip expands by the set Song/Block View Snap value (1 bar) to fit in the moved notes.

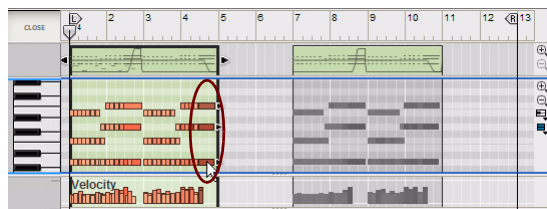

Here, we're going to move the last three notes in the clip to beat 4 in bar 10.

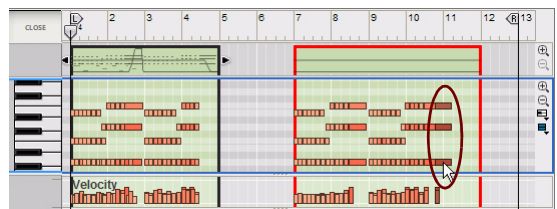

The notes are placed in the other existing clip at beat 4 in bar 10.

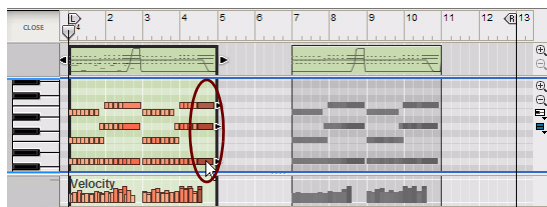

Here, we're going to move the last three notes in the clip to beat 1 in bar 12.

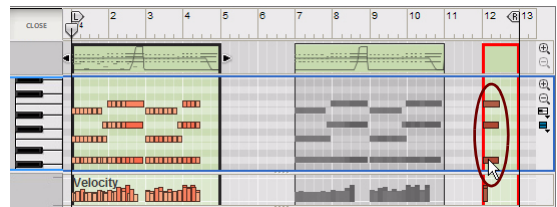

A new clip is created at bar 12 with a length of the set Snap value (1 bar) and the notes are placed in beat 1.

## Changing note pitches (transpose) with the arrow keys

You can use the up/down arrow keys to change the pitches of selected notes by moving them up or down:

- Hold **[Ctrl](Win)** or **[Cmd](Mac)** and use the up or down arrow key to move the selected notes in semi-tone steps.

## Nudging note positions with the arrow keys

You can use the left or right arrow keys to “nudge” the positions of selected note events:

- **Hold [Ctrl](Win) or [Cmd](Mac) and use the left or right arrow key to move the position back or forward by the set Snap value.**
- **Hold [Ctrl]+[Alt](Win) or [Cmd]+[Option](Mac) and use the left or right arrow key to move the position back or forward in Tick increments.**  
There are 240 ticks per 1/16 note so this allows for very fine editing. Check the Tick value in the Inspector when you nudge because typically you won't see the position changes on the Edit Pane, unless you have zoomed in a lot.
- **Hold [Ctrl]+[Shift](Win) or [Cmd]+[Shift](Mac) and use the left or right arrow key to move the position back or forward in Beat increments.**

## About nudging notes outside an open clip

If you nudge notes outside the boundaries of an open clip, the notes will belong to the open clip, but become masked since they are nudged outside the clip boundaries. The “Keep Events in Clip While Editing” setting has no effect when nudging notes. If you want to move notes between clips, or to a new clip, you have to do that using the Selection Tool as described in [“About moving notes outside or between clips”](#).

## Moving notes with the “Alter Notes” function

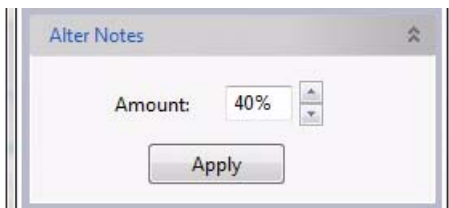

*The Alter Notes pane in the Tool Window.*

The “Alter Notes” function on the Sequencer Tools tab in the Tool Window alters the positions between the selected notes, in a random fashion.

The “Alter Notes” function can be applied to:

- **Individual (selected) note events in a note clip.**  
This has to be done in Edit Mode.
- **All note events in one or several selected note clips.**  
This is done in the Song/Block View. If the clips are on the same lane, it can also be done in Edit Mode.
- ! **In Edit Mode, select clip(s) by clicking on it/them in the Clip Overview.**
- **All note events in all note clips on one or several selected instrument tracks.**  
This has to be done in the Song/Block View.
- **The Alter Notes function will only use the note positions that already exist among the selected notes.**
- **Adjust the alteration amount in with the Amount display.**
- **This function is especially useful for experimenting with rearranging Dr. Octo Rex loop slices. Select some slices on a Dr. Octo Rex track and use Alter Notes to rearrange the slices and create instant variations, without losing the timing and rhythmic feel of the loop.**

## Moving notes with the “Extract Notes to Lanes” and “Explode” functions

It's possible to move defined notes in a clip to new clips on new, additional lanes. See [“Extract Notes to Lanes”](#).

## Moving notes in the Inspector

You can also edit the note positions and pitches numerically in the inspector. See [“Note and automation editing in the Inspector”](#).

## Duplicating notes

### Duplicating notes manually

- **To duplicate selected notes, hold down [Ctrl](Win) or [Cmd](Mac) and press [D].**  
This will duplicate the selection and place it after the selection, at the closest Snap value after the last note in the selection. Repeat the command to continue the duplication for as many times as you like.
- **To duplicate selected notes, hold down [Ctrl](Win) or [Option](Mac) and click and drag a copy of the selection, similar to when moving notes manually (see [“Moving notes”](#)).**
- **You can also duplicate selected notes to a new note clip by right-clicking (Win) or [Ctrl]-clicking (Mac) and selecting [“Duplicate Selected Notes to New Lane”](#) from the context menu.**  
This will automatically copy the selection and paste it in a new note clip on a new, additional note lane.

### Duplicating notes with the [“Extract Notes to Lanes”](#) function

It's possible to duplicate defined notes in a clip and automatically place them on new, additional lanes. See [“Extract Notes to Lanes”](#).

# Using Cut, Copy and Paste

You can move or duplicate events using the Cut, Copy and Paste commands on the Edit menu or context menu.

- **When you use Cut or Copy, the Song Position Pointer is automatically moved to the end of the selection.**  
This is very useful for repeating events, i.e. pasting the selection several times one after another in the song.

## Pasting events outside an open clip

When you use the Paste command, the events will appear at the Song Position Pointer, on the original lane. Depending on the "Keep Events in Clip While Editing" setting in the Preferences dialog, the following rules apply:

- **If the "Keep Events in Clip While Editing" option is active, the notes will belong to the open clip after they have been pasted, but become masked since they are pasted outside the clip boundaries.**  
The clip position and length will remain unchanged.

- **If "Keep Events in Clip While Editing" is deactivated and you paste notes outside the clip, the notes will be placed in an existing clip - or in another new clip on the lane, depending on where you paste them.**  
The picture below shows three scenarios where three notes are being cut and pasted at different positions outside the open clip with the "Keep Events in Clip While Editing" option off. We determine the paste positions by moving the Song Position Pointer:

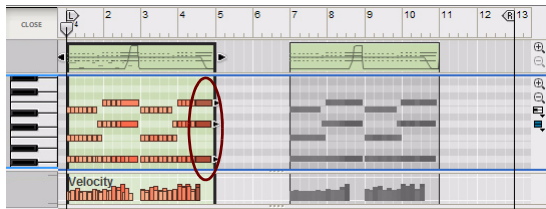

We're going to cut the last three notes in the open clip and paste at beat 3 in bar 5.

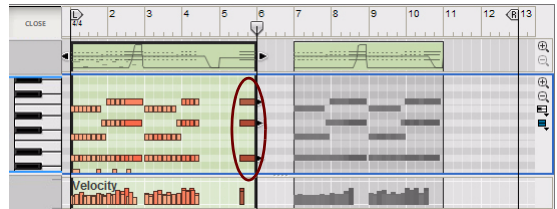

The open clip expands by the set Song/Block View Snap value (1 bar) to fit in the pasted notes.

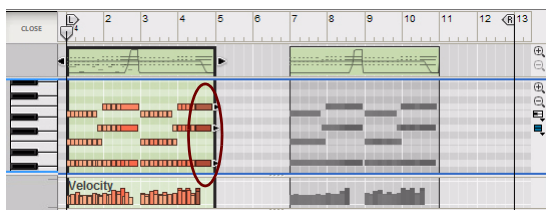

Here, we're going to cut the last three notes in the open clip and paste at beat 4 in bar 10.

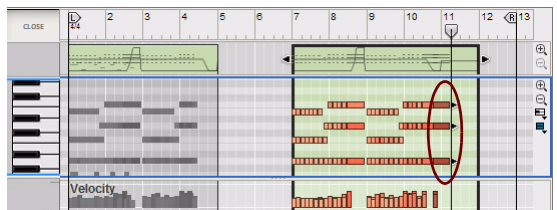

The notes are pasted in the other existing clip at beat 4 in bar 10.

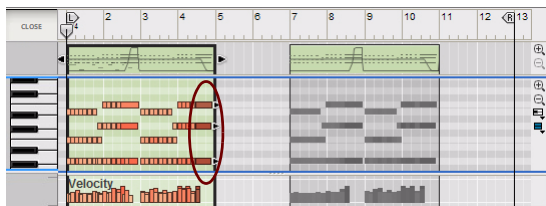

Here, we're going to cut the last three notes in the open clip and paste at beat 1 in bar 12.

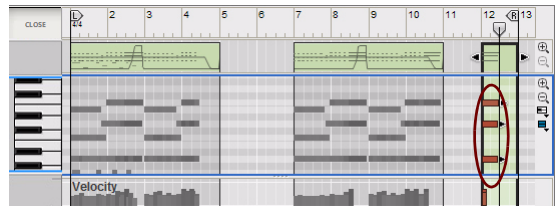

A new clip is created at bar 12, with a length of the set Snap value (1 bar), and the notes are pasted in beat 1.

# Quantize

The “Quantize” function on the Transport Panel and on the Sequencer Tools tab in the Tool Window is normally used for applying quantization to notes - but can also be used for quantizing recorded audio. Clicking the Quantize or Apply button will automatically align the start positions of the selected notes or audio slices to a pre-defined, absolute grid. You can also choose to automatically quantize notes as they are being recorded - see “[Quantizing notes during recording](#)”.

Quantization can be applied to:

- **Individual (selected) notes in a note clip.**  
This has to be done in Edit Mode.
  - **Individual (selected) audio slices in a Single Take audio clip.**  
This has to be done in the inline editor in the Song/Block View.
  - **All notes in one or several selected note clips.**  
This is done in the Song/Block View. If the clips are on the same lane, it can also be done in Edit Mode.
  - **All audio recordings in one or several selected Single Take audio clips.**  
This is done in the Song/Block View. If the clips are on the same lane, it can also be done in the Comp Editor.
- ! In Edit Mode, select clip(s) by clicking on it/them in the Clip Overview.**
- **All notes in all note clips and/or all audio slices in all Single Take audio clips on one or several selected tracks.**  
This has to be done in the Song/Block View.

The quantization grid is selected in the Quantize Value drop-down list on the Transport Panel and/or in the Quantize pane on the Tools tab in the Tool Window:

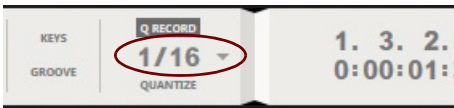

*The Quantize Value drop-down list on the Transport Panel.*

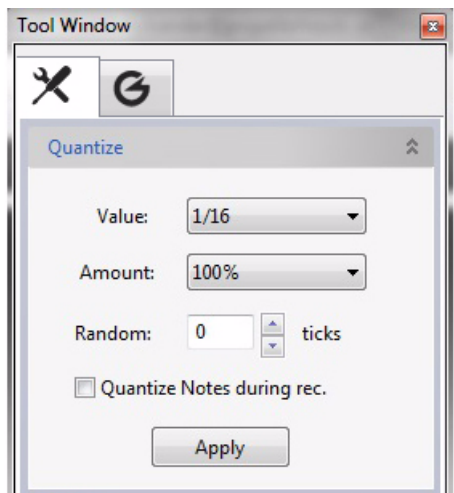

*The Quantize pane in the Tool Window.*

In most situations the Quantize functions on the Transport Panel are probably sufficient. However, if you want more in-depth quantization functionality, perform the quantization in the Tool Window instead.

- You could also use the ReGroove functions for groove quantizing of notes. See “[The ReGroove Mixer](#)”

## Quantizing after recording

1. **Select the note(s)/audio slices, note clip(s)/Single Take audio clips or instrument and audio track(s) you want to quantize.**

Only the notes/audio slices in the clip(s) will be affected - not any parameter automation events.

2. **Select a quantize value from the Quantize Value drop-down list on the Transport Panel, or from the Value drop-down list in the Tool Window.**

This determines to which note value grid the notes/audio slices will be moved when you quantize. For example, if you select 1/16, the notes/audio slices will be moved to (or closer to) the closest sixteenth note position.

- ! **Since several audio slices cannot be quantized to the same position, only the slices closest to the quantize grid will be moved - the other slices will be ignored.**

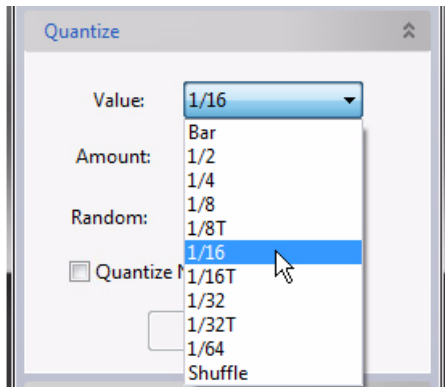

*The Quantize Value drop-down list in the Tool Window.*

A 'T' letter next to some quantization value means Triplets. The effect of using triplets is that three notes are equally distributed over the same time period as two "regular" (non-triplet) notes of the same note value.

3. **Select a value from the Quantize Amount drop-down list.**

This is a percentage, governing how much each note or audio slice should be moved. If you select 100%, the notes/audio slices will be moved all the way to the closest Quantize value positions; if you select 50%, the notes/audio slices will be moved half-way, etc.

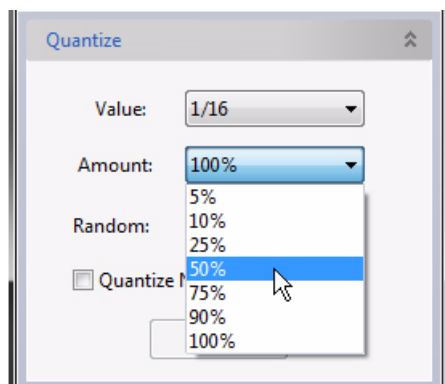

*The Quantize Amount drop-down list in the Tool Window.*

#### 4. Click the Quantize button on the Transport Panel or the Apply button in the Tool Window.

The selected notes are quantized.

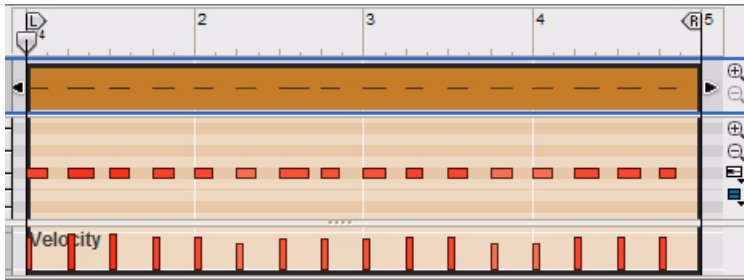
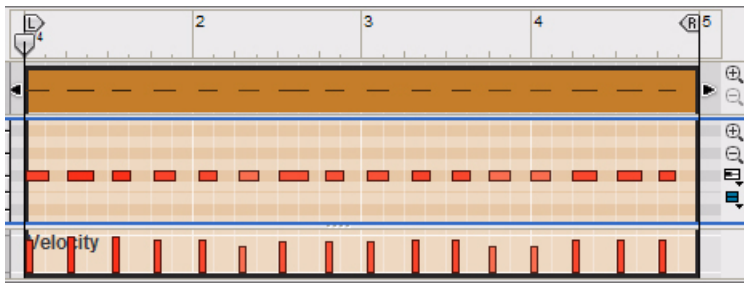

*A sloppily recorded hi-hat pattern is quantized to straight 1/4 notes (Quantize Value 1/4, Amount 100%).*

→ **Quantization can also be applied to note(s), audio slice(s), clip(s) and track(s) by right-clicking(Win) or [Ctrl]-clicking(Mac) and selecting “Quantize” from the context menu.**

The current settings on the “Quantize” pane in the Tool Window will apply when performing this operation.

## Random

You can offset the quantized notes/audio slices using the Random function. The notes/audio slices will be quantized according to the Value and Amount settings, but the note/slice positions will be randomly offset by the set tick value. E.g. if you set Random to 10 ticks, the notes/slice positions will randomly vary within a +/- 10 tick range after applying quantization.

## Quantize to Shuffle

In the Value drop-down list, you will also find an option called “Shuffle”. If this is selected when you quantize, the notes/audio slices are moved towards sixteenth note positions, but with Shuffle applied.

Shuffle creates a “swing feel” by delaying the even-numbered sixteenth notes (the sixteenth notes that fall in between the eighth notes). The amount of Shuffle is set with the Global Shuffle control in the ReGroove Mixer. Quantizing to Shuffle is useful if you want to match the timing with pattern devices in the song (if Shuffle is activated in their patterns).

A more flexible way of doing this for notes and note clips is to use the ReGroove mixer - see [“The ReGroove Mixer”](#) chapter for details.

**! The Amount setting applies as when quantizing to “regular” note values.**

## Quantizing notes during recording

It's also possible to quantize input notes directly during recording. Activation of this function can be made in the Tool Window and/or on the Transport Panel:

- **Enable note quantization by ticking the “Quantize Notes During Recording” check box.**

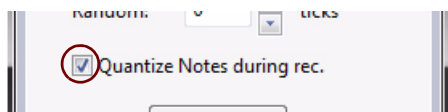

*The Quantize Notes During Recording check box on the Sequencer Tools tab.*

- **Alternatively, click the Q Rec button on the Transport Panel.**



*The Q Record (Quantize Notes During Recording) button on the Transport Panel.*

It doesn't matter where you activate or deactivate this function - the current state is automatically mirrored at the other location.

Any notes recorded after having activated this function will be automatically quantized to the current settings on the “Quantize” pane in the Tool Window, see “Quantize”.

- ! **Audio cannot be quantized during recording!**

## Pitch (Transpose)

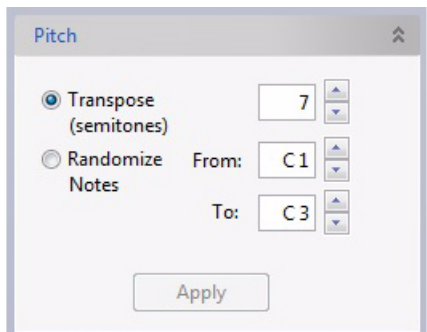

*The Pitch pane in the Tool Window.*

The “Pitch” function in the Tool Window transposes selected MIDI notes, or all notes in selected note clips, or the audio recordings in selected audio clips, up or down in whole semitone steps.

There is also a Randomize function which randomly transposes the pitch of selected MIDI notes in a note clip.

The “Pitch” function can be applied to:

- **Individual (selected) note events in a note clip.**  
This has to be done in Edit Mode.
- **Individual (selected) comp rows in a Comp audio clip.**  
This has to be done in Edit Mode (see “Transposing Comp Rows”).
- **All note events in one or several selected note clips.**  
This is done in the Song/Block View. If the clips are on the same lane, it can also be done in Edit Mode.
- **All audio recordings in one or several selected audio clips.**  
This is done in the Song/Block View. If the clips are on the same lane, it can also be done in the Comp Editor.



- ! **In Edit Mode, select clip(s) by clicking on it/them in the Clip Overview.**
- **All note events in all note clips on one or several selected instrument tracks.**  
This has to be done in the Song/Block View.
- **All audio recordings in all audio clips on one or several selected audio tracks.**  
This has to be done in the Song/Block View.
- ! **In Song/Block View you can transpose a combination of selected note clips/tracks and audio clips/tracks in one go!**

## Transpose (Semitones)

- **Click the “Transpose (Semitones)” radio button and then select the number of semi-tones to transpose the selected notes, note clips and/or audio clips up or down. Click “Apply” to transpose.**
- ! **For MIDI notes and note clips the transposition is “absolute”, i.e. the notes are permanently moved to new note positions in the clip.**
- ! **For audio clips the transposition is non-destructive, i.e. the audio is transposed relative to their original pitch/key without affecting the original audio. For audio clips the relative Transpose amount is also displayed in the Transpose display in the Inspector for the selected audio clip(s). See “[Transposing Audio Clips](#)” for more details about transposing audio clips.**
- **You can also transpose notes by manually moving them using the mouse or arrow keys, as described in “[Moving notes manually](#)” and “[Changing note pitches \(transpose\) with the arrow keys](#)”.**
- **You can also transpose notes numerically in the inspector. See “[Note and automation editing in the Inspector](#)”.**

## Randomize Notes

- **Click the “Randomize Notes” radio button and then select the note range to which to transpose the selected MIDI notes. Click “Apply” to transpose.**  
The selected notes will be randomly transposed within the set note range.

## Extract Notes to Lanes

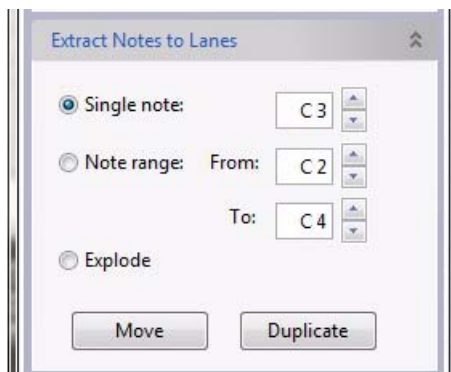

*The Extract Notes to Lanes pane in the Tool Window.*

The “Extract Notes to Lanes” function on the Sequencer Tools tab in the Tool Window is used for moving or duplicating user-defined notes of a certain pitch, or notes within a defined pitch range, to a new note clip on a new, additional note lane. This function is very useful if you, for example, have recorded a drum track, with all notes in the same clip, and then want to extract individual drum sounds (note pitches in this case) to separate lanes to be able to edit them more easily - or to apply ReGroove channels (see “[The ReGroove Mixer](#)”).

The “Extract Notes to Lanes” function can be applied to:

- **Notes of defined pitches in one or several selected note clips.**

If the clips are on the same lane, this can be done in Edit Mode. If the clips are on separate lanes, this has to be done in the Song/Block View.

- ! **In Edit Mode, select clip(s) by clicking on it/them in the Clip Overview.**

- **Notes of defined pitches in all note clips on one or several selected instrument tracks.**

This has to be done in the Song/Block View.

## Extract Notes to Lanes example

We have recorded a 4-bar drum beat, consisting of kick, snare and open+closed hi-hat, in a single clip on a note lane. Now, we want to extract the open and closed hi-hat sounds to a new separate note lane. Normally, this could be done in the Song/Block View, but to better show what happens with the individual note events, we will show this in Edit Mode:

1. **Open the note clip in Edit Mode.**

2. **Click in the Clip Overview to enable the “Extract Notes to Lanes” function.**

Since the Extract Notes to Lanes function applies to selected *clips* and not to selected notes, you have to click in the Clip Overview to enable the function. (In the Song/Block View, you just select the clip by clicking on it).

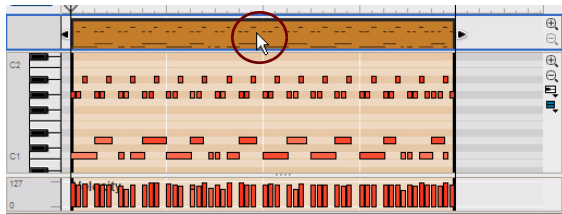

*Click in the Clip Overview to enable the Extract Notes to Lanes function.*

3. **Define which notes you want to move on the “Extract Notes to Lanes” pane in the Tool Window.**

We want to move the open and closed hi-hat notes, i.e. the note range from G#1 to B1. We therefore click the “Note Range” radio button and then select the note range in the “From:” and “To:” displays.

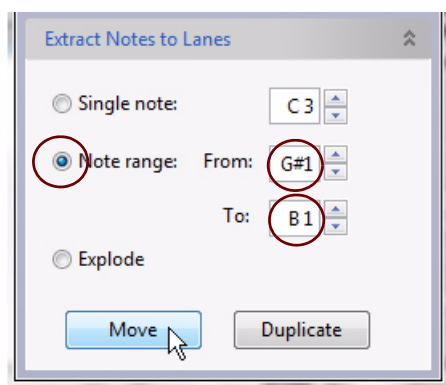

*Select the notes to be moved.*

#### 4. Click the “Move” button on the “Extract Notes to Lanes” pane.

The open and closed hi-hat notes are now moved to a new clip on a new note lane. If we click in the Note Edit lane and scroll, we can see the moved hi-hat notes in the new clip:

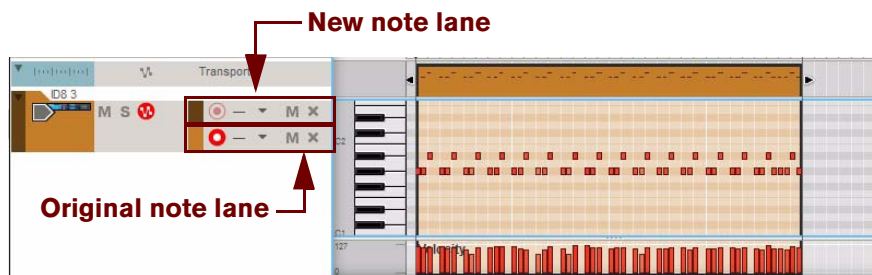

*The moved notes in a new clip on a new note lane.*

If we exit to the Song/Block View, we can see both the original clip and the new clip:

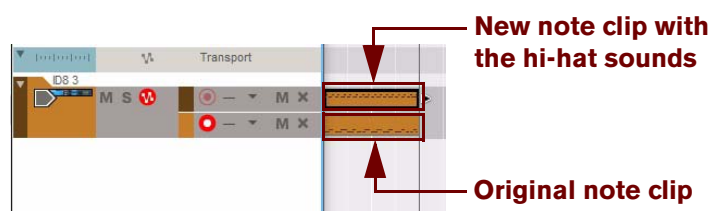

*The original clip and the new clip in the Song/Block View.*

- **If you want to move or duplicate notes of a certain note number only, click the “Single Note” radio button and select the note pitch in the display. Then click, the “Move” or “Duplicate” button.**  
Only the notes of the selected note number will be moved or duplicated to a new clip on a new note lane.
- **The “Extract Notes to Lanes” function is available both in Edit Mode and the Song/Block View, since it’s applied to defined notes in clips and not to manually selected notes.**
- ! **Any recorded performance controller automation will remain on the original note lane.**

### The “Explode” function

- **Click the “Explode” radio button to move or duplicate notes of the same note numbers to new clips on separate note lanes.**  
Notes of the same note number will be moved or duplicated to new separate clips on separate note lanes. A new lane will be created for each of the used note numbers in the original clip
- **The “Explode” function is perfect if you have recorded a drum track and want to move, or duplicate, each individual drum sound to a separate note lane for further editing. Applying different ReGroove channels to each of the generated note lanes could provide extremely nice grooves to the rhythm! See “[The ReGroove Mixer](#)” for more details.**

# Scale Tempo



The Scale Tempo pane in the Tool Window.

The “Scale Tempo” function in the Tool Window can be applied to selected notes and/or automation events. It can also be applied to selected note, audio and automation clips. The Scale Tempo function will make the selection play back faster (Scale factor above 100%) or slower (Scale factor below 100%). For notes and automation events, this is achieved by changing the position of the events (starting from the earliest selected event) and adjusting the length of the notes accordingly. For audio clips, high-quality stretching is applied to all audio recordings in the clip.

Tempo scaling can be applied to:

- **Individual (selected) note and/or parameter automation events in a clip.**  
This has to be done in Edit Mode.
- **All note and/or parameter automation events and/or audio recordings in one or several selected clips.**  
This is done in the Song/Block View. If the clips are on the same lane, it can also be done in Edit Mode.
- ! **In Edit Mode, select the clip(s) by clicking on it/them in the Clip Overview.**
- **All note and/or parameter automation events and/or audio recordings in all clips on one or several selected tracks.**  
This has to be done in the Song/Block View.
- **The “Double” and “Half” buttons are “shortcuts” to Scale factors 200% and 50%, respectively.**  
These are probably the most common values used, simulating double tempo and half tempo scaling.

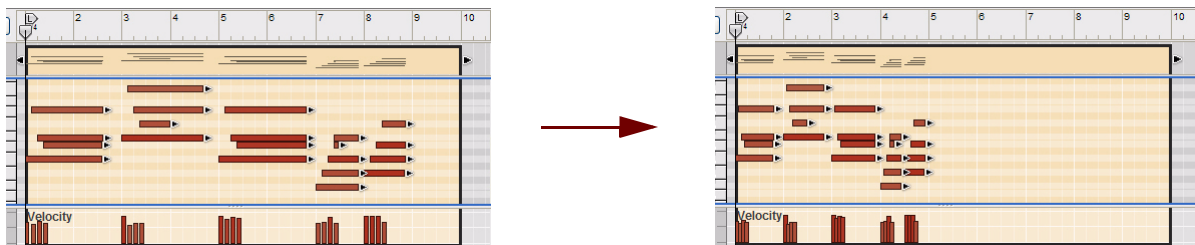

The result of applying Scale Tempo on note events with the Scale factor 200% (double speed).

- **The “Scale to” function can be used for scaling selected clips, or selected events in an open clip, to a fix length.**  
The segments in the “Scale to” box are divided into, bars, beats, 1/16th notes and tics.
- ! **The Scale Tempo function affects note, performance controller, parameter automation, pattern change, tempo automation events and audio clips! It does NOT affect time signature automation.**
- ! **When you are tempo scaling audio clips, make sure you have selected the appropriate Stretch Type, otherwise the sonic result might not be what you’d expect, see “[Selecting Stretch and Transpose Type](#)”.**
- ! **Note that Pattern Automation Clips will only be resized - the pattern tempo in the source device will NOT be scaled but will still be synced to the main sequencer tempo!**

# Editing note velocity

## Editing note velocity manually

The velocity values of notes can be edited manually on the Velocity Edit Lane:

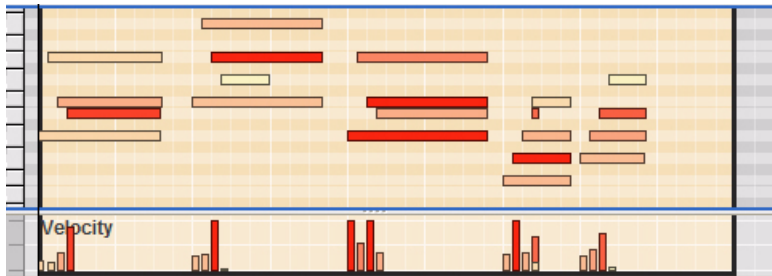

The velocity values are shown as bars, with taller bars indicating higher velocity. Note also that the color intensity of the notes and velocity bars reflect the velocity values.

- **To change the velocity of a note, click on its velocity bar with the Pencil tool and drag the bar up or down. Clicking above or below a bar immediately adjusts the velocity to the level at which you click.**  
You can also edit the velocity of several notes at once by clicking and dragging with the Pencil tool.
- **When the Pencil Tool is selected and you press [Ctrl](Win) or [Option](Mac) on the Velocity Edit Lane, the pencil will change to a cross.**  
This is the Line Tool which is a special tool only available on the Velocity Edit Lane. By dragging across the velocity "bars", at the desired height, you can quickly draw velocity ramps.

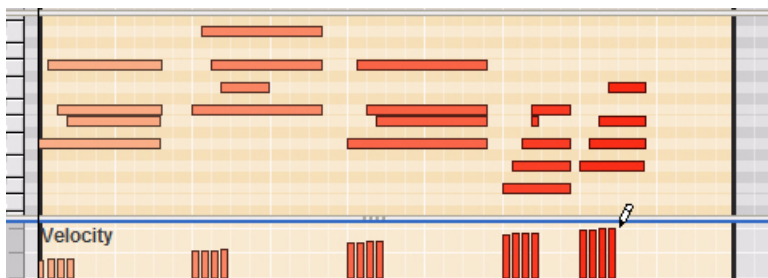
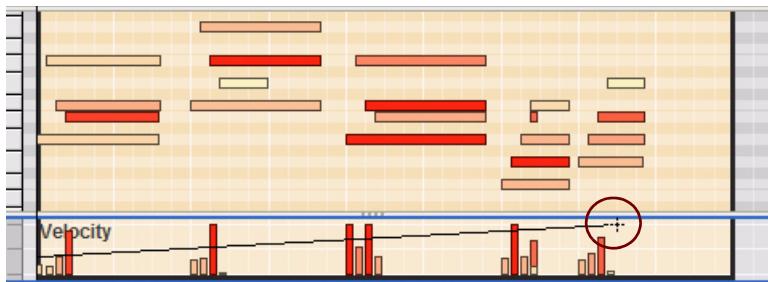

*Drawing a velocity ramp with the Line Tool.*

The Line Tool is probably the preferred method for creating regular, smooth ramps, or for giving all the notes the same velocity (by drawing a straight line), while the Pencil tool can be used for creating more irregular curves.

→ **If you hold down [Shift] when you edit velocity values, only selected notes will be affected.**

This can be very useful, especially in “crowded” sections with lots of notes.

Consider for example if you have a busy drum beat, and want to adjust the velocity of the hi-hat notes only. Simply dragging with the Line- or Pencil tool would change the velocity of all other drum notes in the area too, but if you first select the hi-hat notes on the Drum Edit lane and press [Shift] as you draw, you can edit their velocity without affecting any other notes.

## Editing note velocity with the “Note Velocity” function

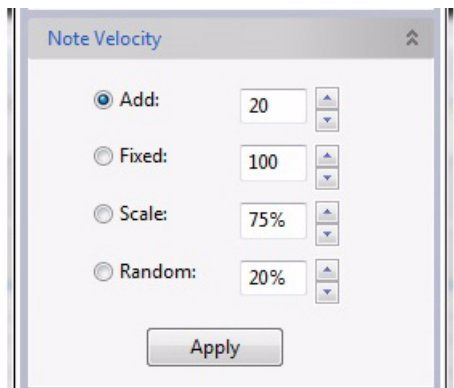

*The Note Velocity pane in the Tool Window.*

The “Note Velocity” function in the Tool Window can be used for adjusting the velocity of selected notes in a number of different ways.

Note velocity can be applied to:

- **Individual (selected) notes in a note clip.**

This has to be done in Edit Mode.

- **All notes in one or several selected note clips.**

This is done in the Song/Block View. If the clips are on the same lane, it can also be done in Edit Mode.

- ! **In Edit Mode, select clip(s) by clicking on it/them in the Clip Overview.**

- **All notes in all note clips on one or several selected instrument tracks.**

This has to be done in the Song/Block View.

- **The “Add” function lets you add a fixed value to the existing velocity values.**

To subtract, choose a negative value. Note that the allowed range is 1-127.

- **“Fixed” allows you to set a fixed velocity value for all selected notes.**

- **The “Scale” function allows you to scale velocities by a percentage factor.**

Scaling by a factor of more than 100% will increase the velocity values, but also make the difference between soft and hard notes bigger.

Scaling by a factor of less than 100% will decrease the velocity values, but also make the difference between soft and hard notes smaller.

- **“Random” will randomize the velocity values by a set percentage value.**

- **By combining the “Add” and “Scale” functions, you can adjust the “dynamics” of the notes in various ways. For example, by using a Scale factor below 100% and adding a suitable value in the “Add” display, you can “compress” the velocity (decreasing the difference between the velocity values without lowering the average velocity level).**

## Editing note velocity in the Inspector

You can also edit velocity values numerically in the Inspector. See [“Note and automation editing in the Inspector”](#).

# Automation editing

## Overview

Automation in Reason is vector-based. This means that automation is stored in clips as automation events (points), connected by lines.

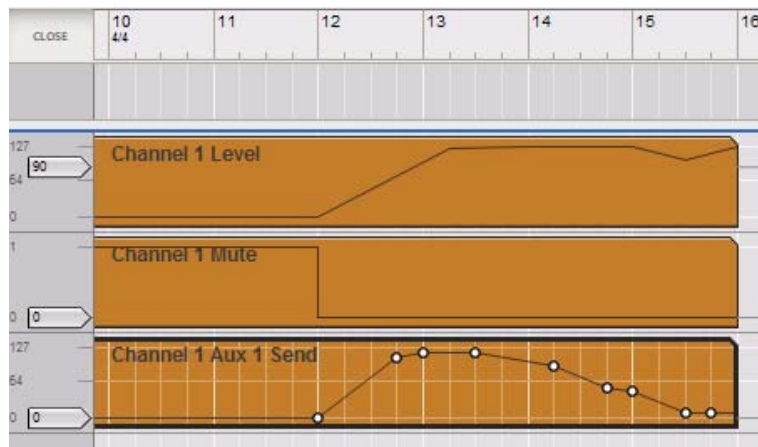

Automation lanes for a Mixer 14:2 Level slider (top), Mute button (middle) and Aux Send slider (bottom) in Edit Mode. The Aux Send automation clip at the bottom is open for editing.

- **Parameter automation is contained in automation clips on Parameter Automation Lanes (see “Edit Mode elements”).**  
Each automated parameter has its own Parameter Automation Lane.
- **Performance controller automation is stored on Performance Controller Edit Lanes in note clips (see “Edit Mode elements”).**

## Editing parameter automation

Parameter automation events can be edited both in the Song/Block View and Edit Mode. In the Song/Block View the parameter automation clip can be opened in sort of a “semi edit mode”, which shows the automation events of the selected clip. You can also edit the parameter’s Static Value. Editing automation events works in the same way, whether in the Song/Block View or in Edit mode.

### Editing parameter automation in the Song/Block View

- **In the Song/Block View, double-click the parameter automation clip on the parameter automation lane.**  
The parameter automation clip is now opened in the Song/Block View:

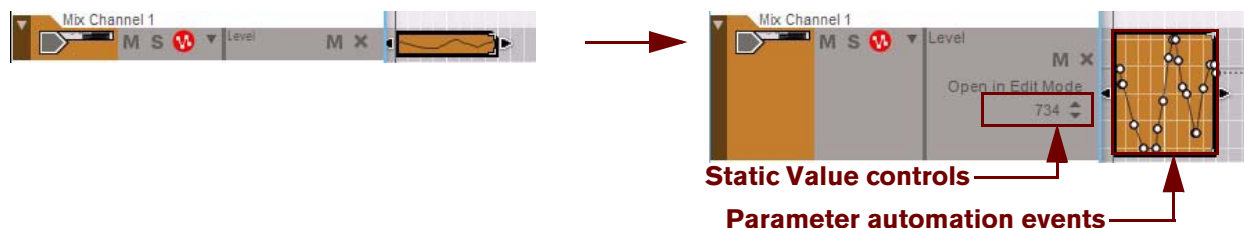

A parameter automation clip before and after opening it in the Song/Block View.

Here you can edit the parameter's Static Value (see "Static Value Handles") with the up/down arrow buttons to the left of the open clip. Alternatively, double-click and type in a new Static Value in the box.

In the open parameter automation clip, it's possible to move, add and delete automation events in the same way as in Edit Mode using the Selection (Arrow), Pencil and Eraser tools - see "Editing parameter automation in Edit Mode".

- **A selected automation event's position and value is also shown in the Inspector.**

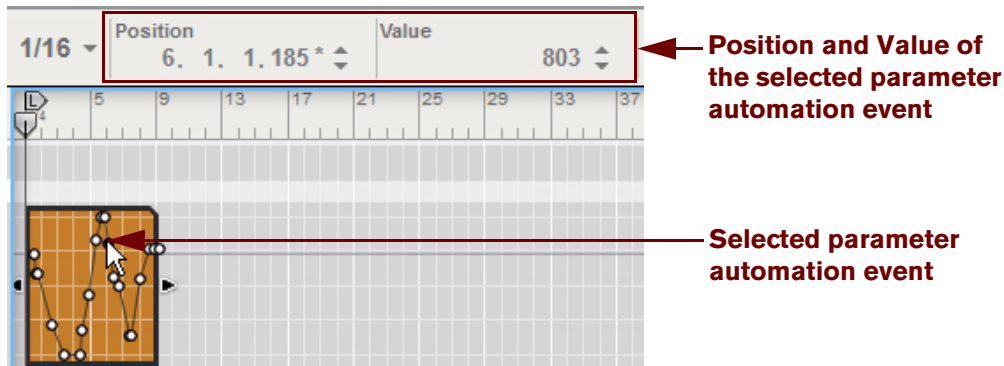

The event's position and value can be edited numerically in the displays - see "Note and automation editing in the Inspector".

- **To close an open parameter automation clip in the Song/Block View, press [Esc] or click on another lane on the Arrangement Pane.**
- **If you resize the automation clip and make it longer, the first and/or last automation value will be extended all the way to the clip boundary.**

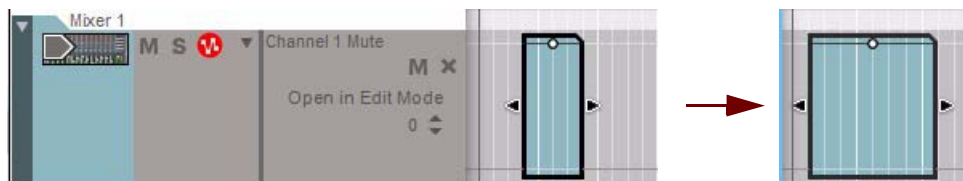

In the picture above, a Mixer 14:2 Mute button is automated. The clip only contains a single automation point, but as we extend the clip in both directions, the value is automatically extended to the start and end of the clip. This means you can adjust the Mute automation time by moving and resizing the clip, without having to open the clip.



## Editing parameter automation in Edit Mode

### 1. Open the parameter automation clip in Edit Mode.

- If the parameter automation clip is on an Instrument Track, just double-click a Note clip to enter Edit Mode.
- If the parameter automation clip is not on an Instrument Track, first double-click the automation clip and then click the “Open In Edit Mode” button.

Use the dividers if necessary to locate the automation clip to edit - these are located at the bottom of the Edit/Arrange Pane (not in the note clip). Parameter automation clips are distinguished by a “cut off” upper right corner.

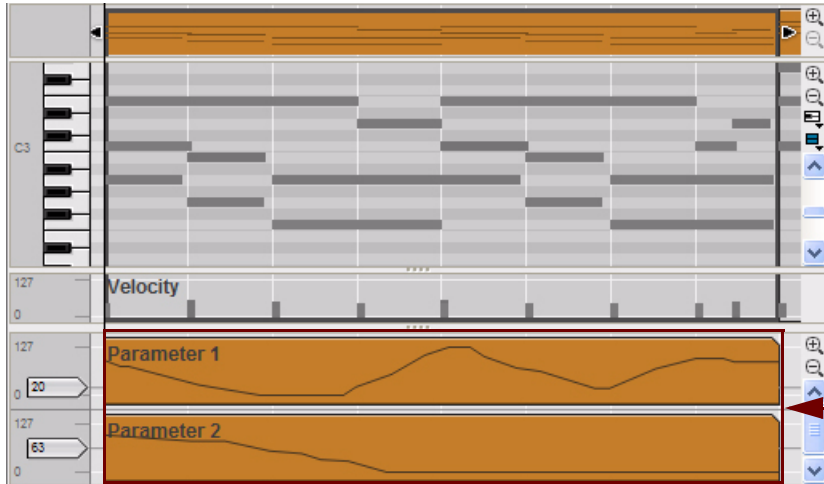

An instrument track in Edit Mode with parameter automation clips at the bottom.

- ### 2. Open the parameter automation clip for editing by double-clicking it or by selecting it and pressing [Return].
- The parameter automation clip is now open for editing.

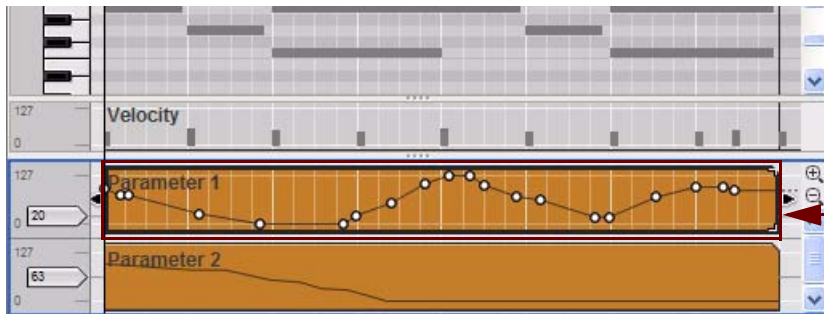

The “Parameter 1” automation clip open for editing in Edit Mode.

In Edit Mode, the parameter’s Static Value is shown to the left in the automation lane. In this example, the Static Value is set to 20 - this means that the “Parameter 1” value will be set to 20 everywhere in the song except where there are automation clips for the parameter.

- To change the Static Value, click and drag the handle up or down, or double-click and type in a new value. To fine adjust the Static Value, hold down [Shift] when you click and drag.

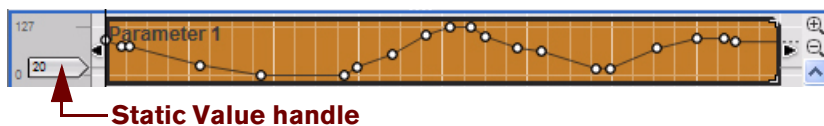

- The Static Value can also be edited in the Song/Block view, see “Editing parameter automation in the Song/Block View”.

### 3. When a parameter automation clip is open, you can select, move, copy or delete automation events, using the Selection (Arrow) Tool.

When moving automation events with the Selection (Arrow) Tool, Snap (see “Snap”) is taken into account if enabled. You can also resize the clip by dragging the clip handles.

- **If you resize the automation clip and make it longer, the duration of the first or last automation event will be extended all the way to the clip boundaries (see the last example in “Editing parameter automation in the Song/Block View”).**
- **A selected automation event’s position and value is also shown in the Inspector.**  
These values can be edited numerically in the Inspector displays. See “Note and automation editing in the Inspector”.

## About moving parameter automation events outside an open clip

If you move parameter automation events outside the boundaries of an open clip, the same rules apply as when moving note events outside an open clip. See “About moving notes outside or between clips”.

## Drawing parameter automation events

To add new parameter automation events, do any of the following:

- **Double click with the Selection (Arrow) Tool in the open automation clip to insert an automation point.**  
Double click, hold, and then drag to draw a series of automation points in the clip.
- **Click or drag with the Pencil Tool in the open automation clip.**  
When dragging, the resulting curve (i.e. the number of points) depends on two factors; the selected “Automation Cleanup” setting in the Preferences menu (see “About Automation Cleanup”), and the snap value if Snap is activated (see “Snap”).
- **Holding down [Ctrl](Win) or [Option](Mac) and clicking or dragging with the Pencil tool will insert an automation range (the same parameter value over a period of time).**  
The length of the range is set with the Snap value.



*Drawing an automation range.*

- **When the automated parameter is “stepped” rather than continuous, there will be abrupt steps between the automation events instead of linear ramps.**  
Examples of stepped parameters could be device buttons and multi-mode selectors, and the Sustain Pedal performance controller.

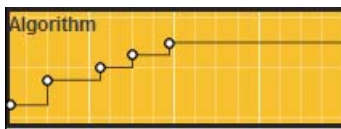

*Stepped automation.*

## About drawing parameter automation events outside an open clip

If you draw parameter automation events outside the boundaries of an open clip, the same rules apply as when drawing note events outside an open clip. See “About drawing notes outside an open clip”.

## Deleting automation events

- Deleting automation events is done in the same way as when deleting note events. I.e. click on events to select them or draw selection rectangles and then press [Backspace] or [Delete] - or use the Eraser tool (see “[Deleting notes](#)”).
- To clear all automation events in a clip, hold down [Ctrl](Win) or [Cmd](Mac) and press [A] to select all events, then press [Backspace] or [Delete]. Alternatively, delete the clip (or remove the whole lane to clear all automation for that parameter).
- If you want to delete single parameter automation events, you can double click on an event with the Selection (Arrow) tool in the clip.

## Editing performance controller automation

- To edit, draw or delete performance controller events, open the note clip in Edit Mode.

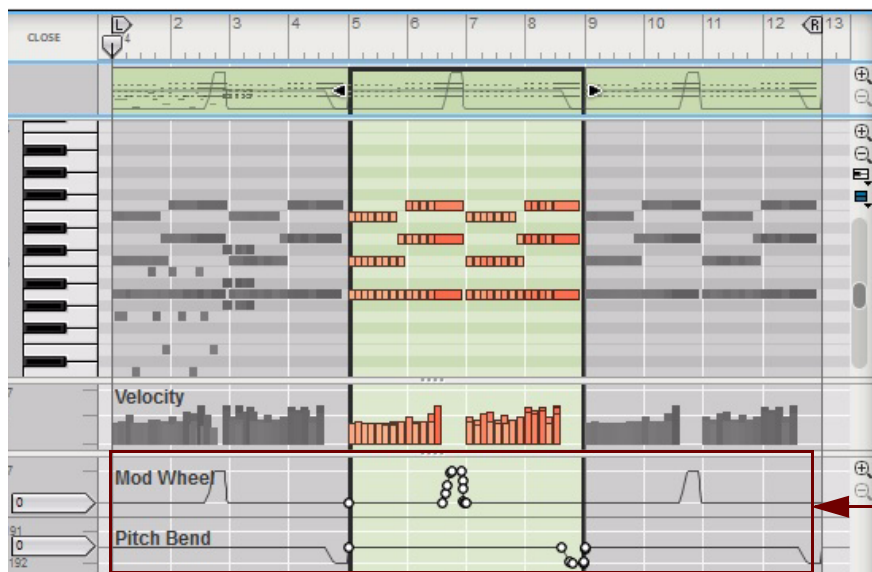

Performance controllers (Mod Wheel and Pitch Bend in the example above) are shown on separate Performance Controller Edit Lanes at the bottom of the open note clip. The performance controller curves are also indicated in the Clip Overview (top), and in the clip in the Song/Block View.

- You can edit performance controller events using the Selection (Arrow), Pencil and Eraser tools, just like when editing parameter automation events in Edit Mode (see “[Editing parameter automation in Edit Mode](#)”).

## Creating new performance controller automation lanes

If you want to manually draw performance controller automation events for a controller which hasn't already been automated, you have to create a new Performance Controller Edit Lane for that parameter. Proceed as follows:

1. **Open the note clip in Edit Mode.**
2. **Select the new performance controller to be automated by clicking on the Performance Controller Automation Selector and selecting it from the pop-up list that appears:**

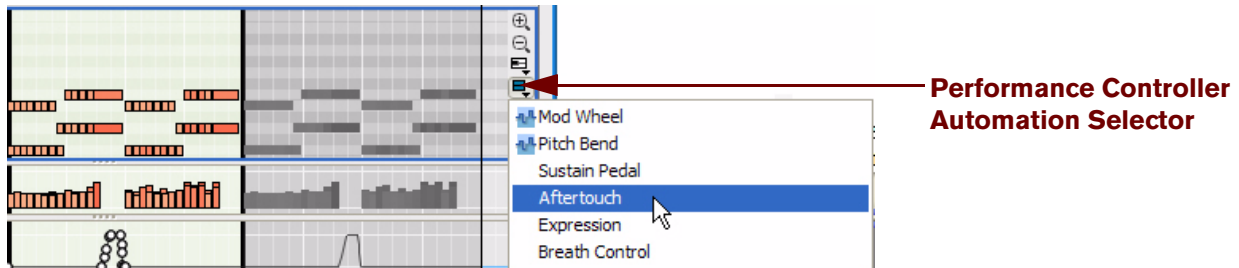

In this example, we select Aftertouch.

3. **A new Performance Controller Edit lane is created for the Aftertouch controller:**

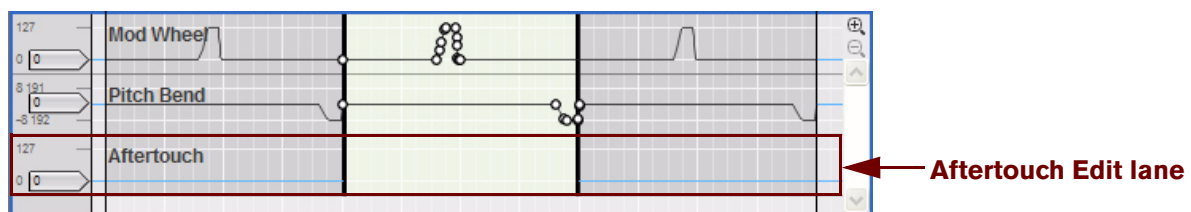

4. **Now, you can draw Aftertouch performance controller events in the clip using the Pencil Tool as described in “Drawing parameter automation events”.**

Afterwards, you can edit the performance controller events the same way as with regular parameter automation events (see “Editing parameter automation in Edit Mode”).

- **It's also possible to add any of the available device panel parameters as a performance controller.**  
Just select the desired parameter from any of the submenus at the bottom of the Performance Controller Automation Selector pop-up menu.

## Deleting performance controller automation lanes

- **To delete a performance controller automation lane, de-select it from the Performance Controller Automation Selector list.**

This brings up a confirmation alert if there is data on the lane (in any clip). You can delete without the alert by pressing [Ctrl](Win) or [Cmd](Mac) when you de-select the parameter from the list.

## About Automation Cleanup

Automation Cleanup is a function for controlling the amount of parameter automation events that should be created during recording and/or manual drawing. The Automation Cleanup function applies to parameter automation events as well as to performance controller automation events. The Automation Cleanup level can be set in the Preferences menu and will apply to all new recorded automation events. You can also use the function on previously recorded parameter automation events. This is done on the Tools tab in the Tool Window.

### Automation Cleanup in the “Preferences” menu

→ If you feel you get too many automation events when recording or drawing events, you can adjust the “Automation Cleanup” setting in the Preferences dialog - General page to “Heavy” or “Maximum”:

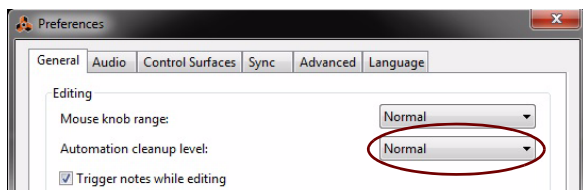

This automatically removes superfluous automation events next time you record or draw events and simplifies the curves. Note that Snap (see “Snap”) also governs the number of events when drawing events.

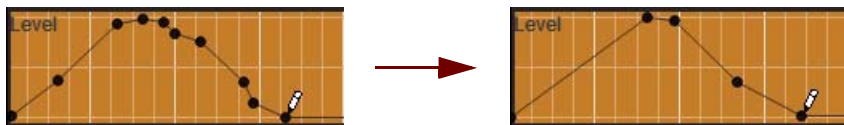

*Drawing automation with “Normal” Cleanup (left), and with “Maximum” Cleanup (right).*

### The “Automation Cleanup” function in the Tool Window

You can also apply Automation Cleanup to already recorded/drawn events. This is done on the Sequencer Tools tab in the Tool Window:

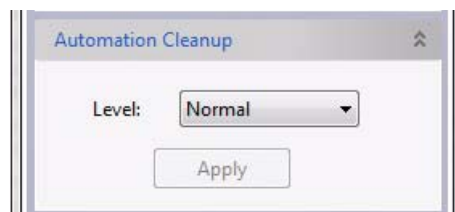

*The Automation Cleanup pane in the Tool Window.*

The “Automation Cleanup” function can be applied to:

- **Individual (selected) parameter automation events in an open clip.**  
This has to be done in Edit Mode for performance controllers. For parameter automation, it can be done in both Edit Mode and the Song/Block View.
- **All parameter automation events in one or several selected clips.**  
This is done in the Song/Block View. If the clips are on the same track, it can also be done in Edit Mode.
- **All parameter automation events in all clips on one or several selected tracks.**  
This has to be done in the Song/Block View.

# Editing pattern automation

Pattern automation clips are viewed and edited in the Pattern Select lane, which is available on Dr. Octo Rex, Redrum and Matrix tracks:

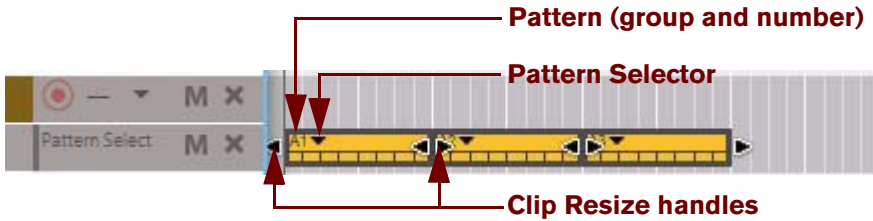

Pattern changes are shown as clips with a Pattern Selector at the top (when the clip is selected). A single pattern automation clip can only contain data for a single pattern. In practice this means that each pattern automation clip only contains one pattern automation “event”. All pattern changes in the song will therefore require unique clips.

- **Pattern (group and number)**

The Pattern (group and number) indicate which pattern in the source device is playing in this clip. For Dr. Octo Rex devices, the Bank is of no importance.

- **Pattern Selector**

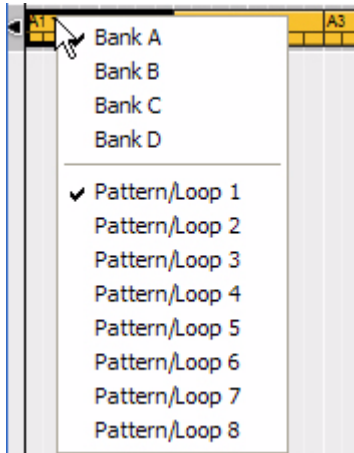

Click the Pattern Selector triangle, or double-click anywhere in the clip, to bring up a pop-up list featuring all available patterns (groups and numbers) of the source device. Select another pattern from the list if you wish to change pattern in the selected clip. If several pattern clips are selected, selecting a pattern for one of them will set them all to play that pattern.

- **Clip Resize handles**

Click and drag any of the Clip Resize handles horizontally to resize the clip and thus change the pattern playback start position and/or duration.

**! If there is pattern automation for a device, it will only play patterns where there are pattern clips.**

# Drawing pattern automation

You can draw pattern automation clips on a Pattern Select lane as follows:

## 1. Activate Snap and set the Snap value to the note position where you want to insert the pattern change clip (see “Snap”).

It is probably a good idea to set the Snap value to “Bar”, at least if you are working with patterns of a length corresponding to the time signature (e.g. 16 or 32 step patterns and 4/4 time signature). However, if you are working with patterns of another length, it can make sense to use other Snap values when drawing pattern automation clips.

## 2. Select the Pencil Tool.

A Pattern/Loop drop-down list appears in the Inspector. Use this to select the pattern you wish the clip to play. For Dr. Octo Rex devices, the Bank is of no importance.

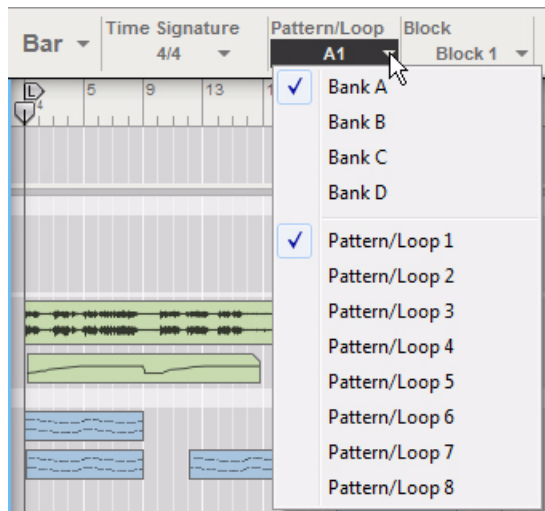

## 3. Draw a clip for length you want the selected pattern to play.

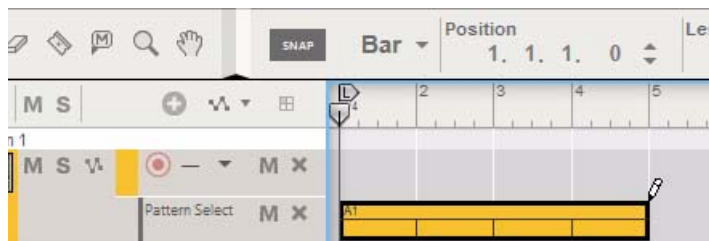

## 4. Continue using the same method to draw clips for all the patterns you wish to use.

- Don't draw pattern change clips with Snap turned off, unless you want chaotic pattern changes!
- If you want to add single pattern change clips, you can also double click with the Selection (Arrow) tool on the Pattern Select lane.

This will create an empty pattern change clip with the length of the current Snap value setting (e.g. 1 bar). To create longer clips, double click, keep the mouse button pressed and drag to the right.

## Moving, resizing and duplicating pattern automation clips

- You can move, resize and duplicate pattern automation clips in the same way as with note or automation clips. However, it is recommended that Snap is activated (and in most cases set to "Bar") when you do this (see "Snap").
- ! If you resize a pattern automation clip by clicking and dragging the left resize handle, and thus change the start position, the clip will be masked (just like a note clip). This means the pattern won't necessarily begin on beat 1. A selected pattern automation clip that has a masked start position will indicate this in the Pattern Offset display in the Inspector.

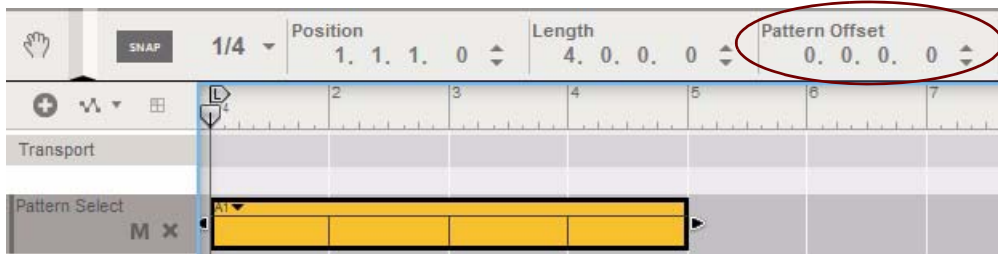

A pattern automation clip drawn between bar 1 and 5.

Now, if we resize the clip by dragging the left resize handle two beats to the right, the Pattern Offset will change but the pattern will play back as expected:

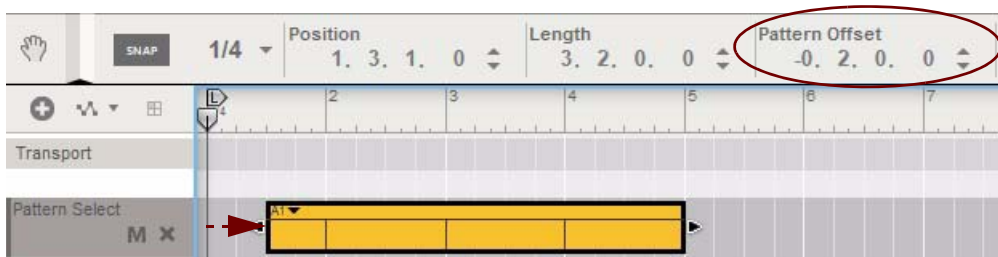

The same pattern automation clip "resized" to begin at beat 2.

- You can also move or duplicate pattern automation clips using the Cut, Copy and Paste commands on the Edit menu or context menu. Again, the same rules apply as for note and parameter automation clips.

## Deleting pattern automation clips

- Deleting pattern automation clips is done in the same way as deleting note clips. I.e. you can select or draw selection rectangles and then press [Backspace] or use the Eraser tool etc.
- To clear all automation in a clip, simply delete the clip (or remove the whole lane to clear all pattern change automation on the track).



## The “Convert Pattern Automation to Notes” function

If you have recorded or drawn pattern automation on a Redrum or Matrix track, you can automatically convert the whole pattern automation lane into note events on an additional note lane. Proceed as follows:

**1. Select the track with the pattern automation.**

**2. Select “Convert Pattern Automation to Notes” from the Edit menu or the track’s context menu.**

For each pattern automation clip, the corresponding device pattern is converted to note clips on an additional note lane on the track. The generated note lane will play back just the same as when you played the pattern device with the pattern changes.

• **The pattern automation lane is automatically disabled (turned off) after this operation.**

You can later go back to pattern automation if you wish, by turning on the pattern lane again.

### Redrum specifics:

• **The “Enable Pattern Section” switch on the Redrum device is automatically turned off when you use the “Convert Pattern Track to Notes” function.**

### Matrix specifics:

• **Make sure that the correct track is selected (normally the track for the device that the Matrix is connected to)!**

Creating notes for the Matrix itself is pointless, as the Matrix cannot produce any sound.

• **You may want to disconnect or even remove the Matrix device after performing this function.**

This is because you probably don’t want both the Matrix and the sequencer notes to play the device at the same time.

## Editing tempo automation

Tempo automation is edited in the same way as regular parameter automation. See [“Editing parameter automation”](#).

### Drawing tempo automation events

Drawing tempo automation events is done in the same way as drawing regular parameter automation events. See [“Drawing parameter automation events”](#).

• **Even though Reason supports a very wide tempo range (1.0 BPM to 999.999 BPM), the initial displayed editing range is 60-250 BPM in the left column in Edit Mode. This is only to make it easier to work with small tempo changes.**

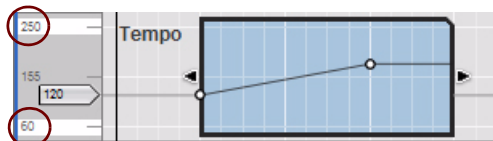

If you want higher tempi than 250 BPM, or lower than 60 BPM, you can easily expand the range, either by selecting and moving a tempo automation event above, or below, the clip border, by double-clicking the max or min values (“250” or “60” in the left column in the picture above) and typing in a new value, or by selecting an event and changing its value in the Value display in the Inspector.

## About tempo changes and tempo automation of audio tracks

The built-in Stretch function allows you to change the tempo of the song without affecting the pitch of the recordings on the audio tracks. This is great if you want to adjust the tempo after you have recorded your audio tracks. In Reason, the Stretch is enabled by default for all audio clips.

! **The Stretch function also affects the sonic result when transposing audio clips using the Transpose function (see “Transposing Audio Clips”).**

There are three selectable Stretch and Transpose Type algorithms which are suitable for playing back different types of audio material:

- **The “Allround” Stretch and Transpose Type is suited for most types of polyphonic audio material.**
- **The “Melody” Stretch and Transpose Type is best suited for sources sounding one note at a time e.g. solo instruments.**
- **The “Vocal” Stretch and Transpose Type is best suited for stretched and/or transposed vocal material.**  
In the “Vocal” Stretch and Transpose Type the formants of the original vocal are preserved, which prevents the vocal from sounding artificial when transposed and/or stretched.

→ **Select “Stretch and Transpose Type” from the Audio Track context menu or from the Edit menu.**

### Stretch preview vs. high quality stretch

Stretch and transposition of audio are always made in two parallel steps: a real-time “preview” so that you can instantly hear the result of your tempo changes or transpositions, and a high quality stretch “in the background” to further improve the sonic results. As soon as high quality stretch is in progress, the “Calc” indicator on the Transport Panel shows a progress indicator:



*The CALC indicator appears when Reason performs high quality stretching of audio.*

Since the high quality stretch is performed in the background, you can still continue to work with your song without any interruption. When the high quality stretch is finished, the “Calc” indicator goes out and the high quality audio automatically replaces the “preview” audio.

### About disabling Stretch for audio clips

In some situations, you might want to exclude audio clips from tempo automation. For example, if you have recorded dialogue or sound effects that shouldn't adapt to tempo changes. In such situations, you can select the audio clip(s) you want to exclude from the tempo changes and select “Disable Stretch” from the Edit menu or clip context menu.

! **Note that disabling stretch does not affect the Transpose function for audio clips!**

## Automating time signature

Time signature automation events can only be manually drawn with the Pencil tool - not recorded like tempo automation, parameter automation or performance controller automation. A single time signature automation clip can only contain a single time signature value. In practice this means that each time signature automation clip can only contain one time signature automation “event”. All time signature changes in the song will require a unique clip.

### 1. Set the desired time signature in the Signature display on the Transport Panel.

This will be the Static Value, i.e. the time signature of the song wherever there is no clip present on the time signature automation lane.

### 2. Hold down [Alt](Win) or [Option](Mac) and click in the Signature display on the Transport Panel.

This will select the Transport track and create a time signature automation lane in one go. The Signature display will also be displayed with a green border, indicating that the time signature has been automated.

→ It is generally a good idea to activate Snap (see “Snap”) and have the Snap value set to “Bar” when drawing clips.

### 3. Select the Pencil Tool.

When the Pencil tool is selected, a Time Signature drop-down list appears in the Inspector. Select the desired time signature from the drop-down list.

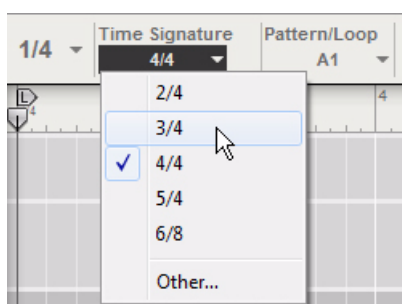

→ If you select “Other” the Edit Time Signature dialog appears where you can specify another time signature.

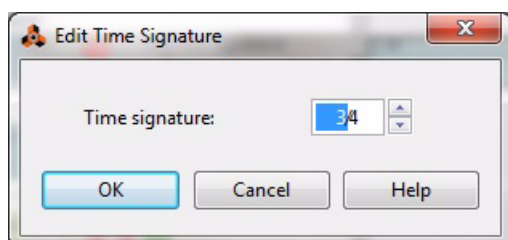

The available signatures are: 1/2-16/2, 1/4-16/4, 1/8-16/8 and 1/16-16/16. The Time Signature display in the dialog can be edited according to the descriptions in “Transport Panel segment displays”.

### 4. Draw a clip over the area on the Time Signature lane in the Transport track where you want the time signature to change.

The time signature will change for the duration of the clip.

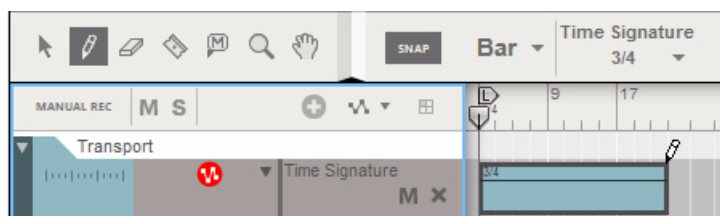

5. Continue using the same general method wherever you want the time signature to change in your song.

- **If you want to add single time signature clips, you can also double click with the Selection (Arrow) tool on the Time Signature lane.**

The clip gets the length of the currently selected Snap value.

- **You can change the time signature for the automation clip at any time by simply double-clicking the clip with the Selection (Arrow) Tool and changing the value on the pop-up that appears. Alternatively, select the clip and then click the small triangle in the clip to bring up the time signature pop-up.**

There is no need to switch to Edit Mode unless you wish to change the time signature's Static Value.

## Moving, resizing and duplicating time signature automation clips

- **You can move, resize and duplicate time signature automation clips in the same way as with note or automation clips.**

However, it is recommended that Snap is activated (and in most cases set to “Bar”) when you do this.

- **You can also move or duplicate clips using the Cut, Copy and Paste commands on the Edit menu or context menu.**

Again, the same rules apply as for cutting, copying and pasting note and parameter automation clips.

## Deleting time signature automation clips

- **Deleting time signature automation clips is done in the same way as deleting note clips. I.e. you can select or draw selection rectangles and then press [Backspace] or [Delete], or use the Eraser Tool.**
- **To clear the time signature automation in a clip, simply delete the clip (or remove the whole Time Signature Lane to clear all time signature automation on the track).**

# Note and automation editing in the Inspector

In the Inspector you can edit note and automation events numerically using the displays.

## Editing notes and events in the Inspector

If you select a note, four displays appear in the Inspector, showing the event (start) Position, Length, Note number and Velocity value:

Position	Length	Note	Vel
4. 1. 3. 0	0. 0. 0. 219*	F 1	68

If you select a parameter automation event, two displays appear, showing the event's Position and Value:

Position	Value
6. 1. 1. 185*	803

If you select a pattern automation clip, three displays appear, showing the clip's Position, Length and Pattern Offset:

Position	Length	Pattern Offset
1. 1. 1. 0	4. 0. 0. 0	0. 0. 0. 0

- **Edit the values by clicking on a segment in a display and then drag up/down, use the up/down spin controls, or type in new values. Snap is not taken into account.**  
See [“Inspector segment displays”](#) for details on how to edit in the Inspector displays.
- ! **Note that when moving the position of events, these may end up outside the clip and be masked (not played). There will be no warning or indication if this should happen. However, since the clip is open in Edit Mode, you will be able to see if events are masked.**
- **If the Tick segment in the Position and/or Length displays shows an asterisk (\*), it means that the value is a fraction of a Tick - a subtick. See [“About subticks in the Position and Length displays”](#) for more info.**

## Editing values for multiple notes or events in the Inspector

When you edit values for several selected events, the changes will always be relative. For example, if you change the position, length, pitch or velocity when several notes are selected, they will all be changed by the same amount, retaining their relative values.

- **If several events are selected, the displays will show the values for the event with the earliest start position in the song.**  
If several selected events have the same start position, the displays will show the values for the event with the lowest Note value (for note events) or lowest Value (for automation events).
- **If several events are selected and any of their values differ, Match Value buttons appear next to the corresponding display.**  
See [“Matching notes or events using the “Match Values” function”](#).

## Matching notes or events using the “Match Values” function

Position	Length	Note	Vel
3. 1. 1. 0	1. 2. 3. 3*	C 3	107

The Match Values buttons appear as '=' signs.

The “Match Values” function in the Inspector can be used for matching the positions, lengths and velocities of several selected note events to the position/length/velocity of the selected event with the earliest start position in the song. It’s always the values of the earliest event that are shown in the displays. Similarly, automation events can be matched to the position and/or value of the earliest selected automation event in the song.

If several selected events have the same start position, the matching will be to the values for the event with the lowest Note value (for note events) or lowest Value (for automation events).

## Matching notes

Here’s an example on how to match note values:

### 1. In Edit Mode, select several notes.

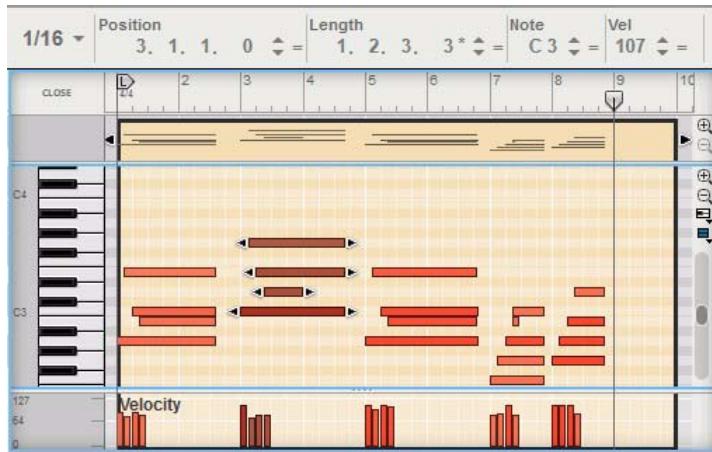

Four selected notes in Edit Mode.

### 2. Click the respective Match Values button to achieve the following results:

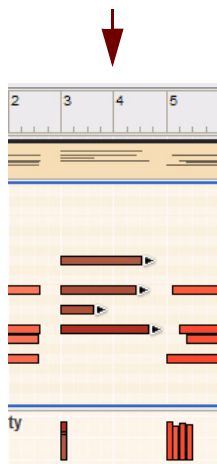
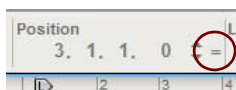

Position values matched

or

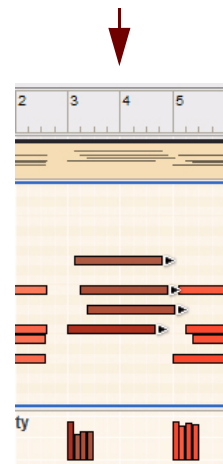

Length values matched

or



Velocity values matched

## Matching parameter automation events

Matching parameter automation event values is useful if you want an automated device parameter to be modulated to the same value throughout the clip.

- **Let's say you want to modulate a parameter to a maximum value of 80 several times throughout the clip. Then, just select all "max value" events, click the "Match Values" button and then adjust the Value to 80 for the selected events.**

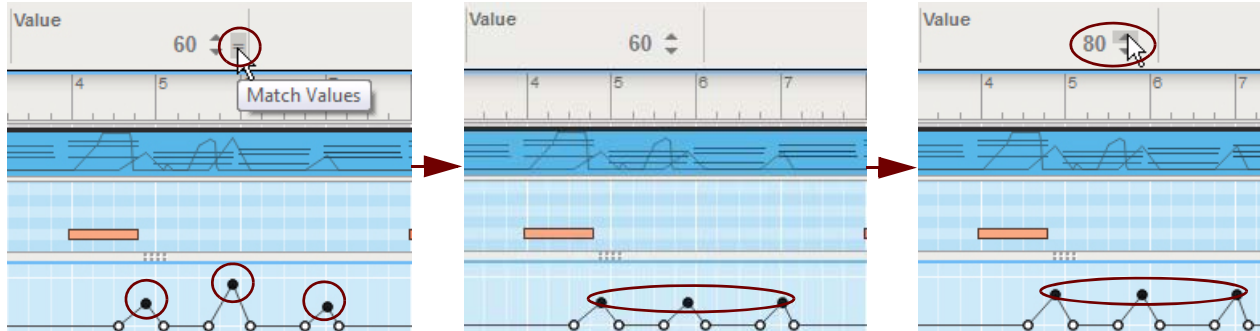

Matching automation events positions can be useful under the following circumstances:

- **If you want to match the positions of single performance controller events on several Performance Controller Automation lanes.**

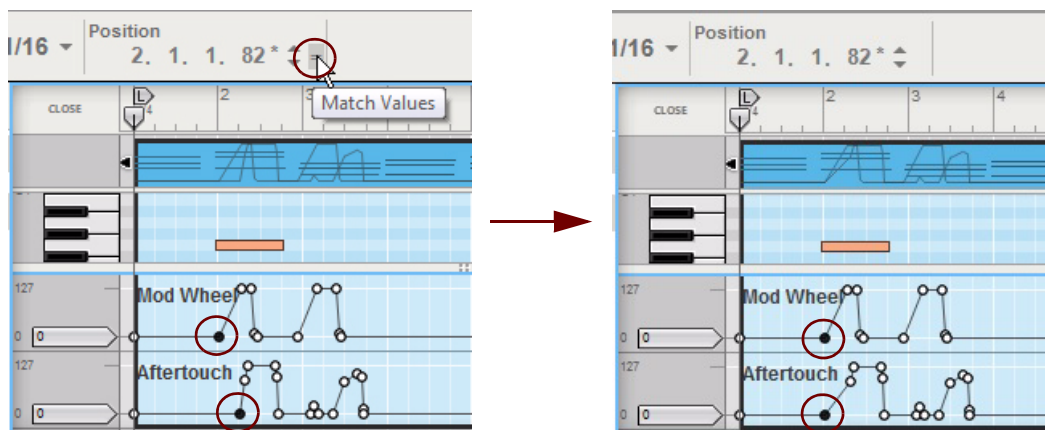

- **If you want to match the position of two adjacent automation events in a clip to create an instant "jump" between the two values.**

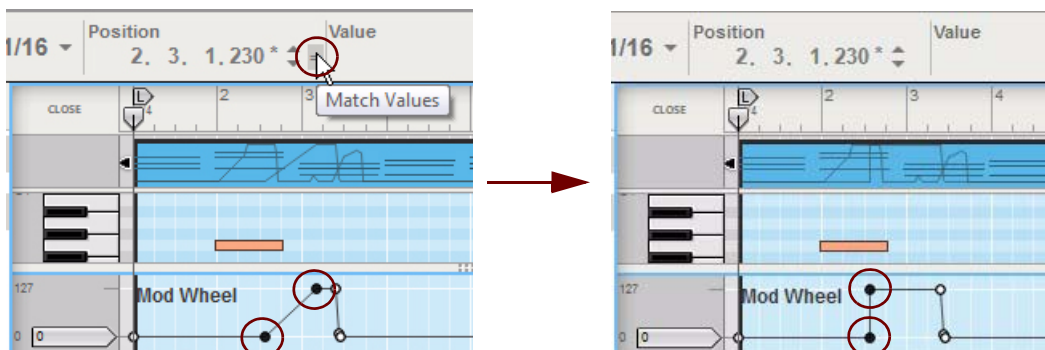

Matching the positions of several automation events in a single clip is not really useful. It will only place them in a "pile" on the same position. The effect during playback would be an instant jump between the extreme values. In practice, all events in between the extreme values will be disregarded.





# **Chapter 10**

## **Working with Blocks in the Sequencer**

# About this chapter

This chapter describes how to work with Blocks and Block Automation Clips in the main sequencer. Basic sequencer functions, recording, editing clips and events and arranging in the sequencer are described in detail in the chapters “Sequencer Functions”, “Recording in the Sequencer”, “Audio Editing in the Sequencer”, “Note and Automation Editing” and “Arranging in the Sequencer”.

## Introduction

The arrangement in the sequencer has two basic views: the Song View, which is exactly the same as the “Arrange Mode” in previous versions of the program, and the Blocks view. The Block View is designed for creating shorter multi-track “sections” that can be repeated anywhere in the song arrangement. In most situations a Block would probably consist of 4-8 bars.

An analogy to a Block would be a traditional drum machine pattern where you would record several (drum) instrument tracks and save as a complete “pattern”. Then, you would build up your song arrangement by arranging your patterns, one after another, with repetitions etc.

The Song and Block Views share the same Track List but use separate clips and recordings. Any track and clip types can be used when working with Blocks, e.g. instrument tracks with note clips, audio tracks with audio clips, automation tracks with parameter automation clips and pattern tracks with pattern automation clips.

32 different Blocks are available in the program and each Block can be reused and repeated in the song arrangement as many times as you like. By working with Blocks you can create complete verse and chorus blocks and arrange and reuse them as desired in the song. When you arrange your Blocks in the song - using Block Automation Clips - you can also choose to temporarily mute desired lanes for the duration of each Block Automation Clip to create variations.

## The idea behind Blocks

Working with the sequencer in a “pattern based” fashion appeals to many users. It is the way traditional hardware sequencers worked when they were first introduced on the market. The linear working method of most software sequencers also have many advantages. So, why not combine these two basic working methods to get the best of both worlds!

A very neat way of working with Blocks is by combining Block data with regular linear song data. In the picture below, Block data is being used as base for the song. Then, a number of shorter linear clips are used to override parts of the Block data to introduce nice variations in the song:

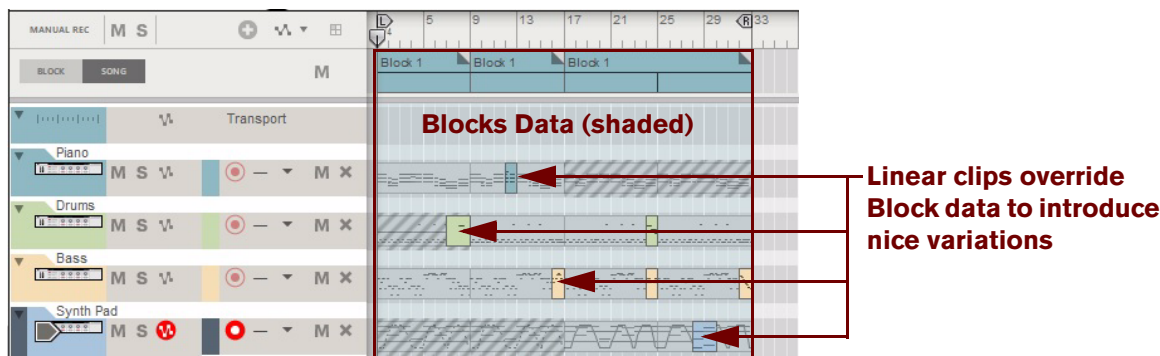

*Linear clips override Block data to create nice variations in the final arrangement.*

# Arrangement Views

## Song View (with Blocks disabled)

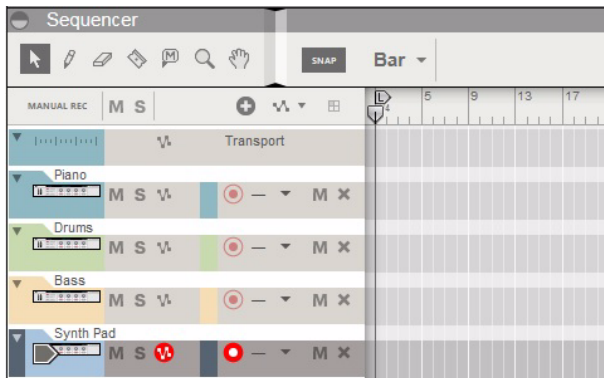

*The sequencer in the Song View.*

This is the Song View, which is the same as “Arrange Mode” in older versions of the program. Here you work with your song in a linear fashion, by recording and arranging your clips from the start of the song to the end. Songs created in previous versions of the program will automatically open up in the Song View, so it will all look very familiar.

## Song View (with Blocks enabled)

When you create a new song, or a song from a template, the sequencer will automatically have the Blocks function activated. However, if you open a song that was previously saved with the Blocks function off, you will have to manually activate Blocks:

- **Select “Enable Blocks” on the Options menu to enable the Blocks function.**

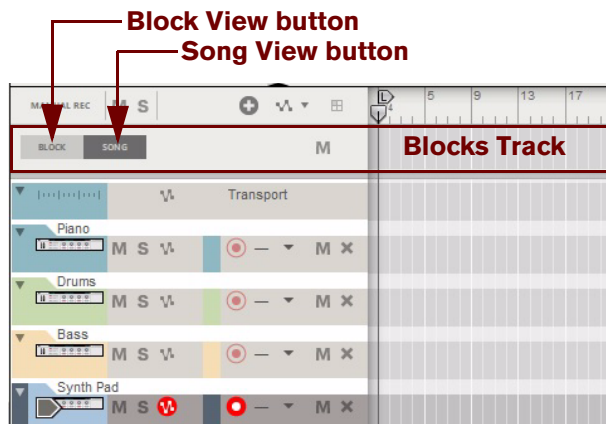

*The sequencer in Song View with “Enable Blocks” activated*

With Enable Blocks activated on the Options menu, an additional track - the Blocks Track - becomes available above the Transport Track. On the Blocks Track you can arrange your Block Automation Clips once you have recorded your Blocks. There are also two buttons to the left on the Blocks Track in the Track List: the Block and Song View buttons.

# Block View

→ **Click the Block button on the Blocks Track to switch to the Block View.**

A colored area appears on the arrangement pane with the Block name at the top on the Blocks Track. By default, the Blocks are named “Block n” where “n” is a number between 1 and 32. If you like, you can rename your Blocks to more suitable names (see [“Renaming Blocks”](#)). The Block View is where you record the clips you want to include in a specific Block. The clips present in the colored Block area in the Block View are unique only to that specific Block.

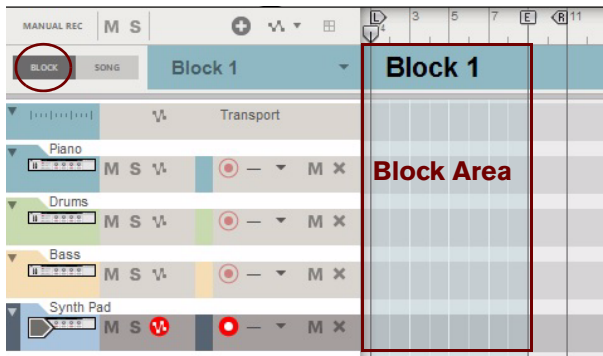

*The sequencer in Block View*

! **The Song View and Block View share the Track List. However, the clips on the lanes are unique to the respective views. This means you can have clips in the Song View “on top” of clips in Blocks. See [“Combining Block Automation Clips with Song Clips”](#) for more details.**

## Editing Blocks in the Block View

### Selecting a Block for editing

Selecting a Block for editing is done in the Block View. Select the Block you want to work with as follows:

1. **Make sure “Enable Blocks” is activated on the Options menu.**
2. **Click the Block button on the Blocks Track to switch to Block View.**

Block 1 appears by default on the arrangement pane:

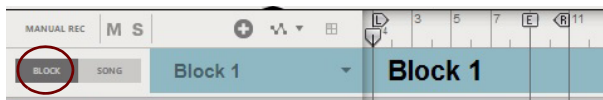

3. **Select a Block (1-32) from the Blocks drop-down list in the Track List if desired.**

In this example, we will stick to Block 1. The Block name is shown on the Blocks Track.

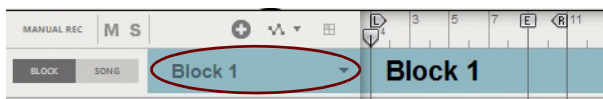

## Renaming Blocks

If you don't want to use the default Block names you can easily rename them:

→ **Double-click the Block name on the Blocks Track in the Block View, type in a new name and press [Return].**

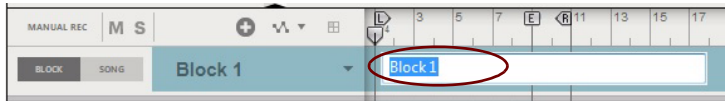

## Defining the Block length

The length of a Block is defined using the End Marker in the Blocks view:

1. **Select desired Block in the Block View as described in “Selecting a Block for editing”.**
2. **Adjust the End Marker to the desired position by clicking and dragging it in the Ruler.**

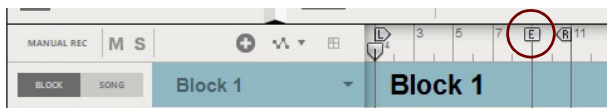

- **The Block length is always defined from the beginning of the Ruler to the End Marker.**  
The Left and Right Loop Locators have no influence on the Block length.
- **When the sequencer is running in Block View, it will automatically loop at the End Marker.**  
The Loop Locators can also be used in Block View to loop at other positions, if Loop On/Off is activated on the Transport Panel. However, in Song View the Loop Locator settings used in the Block View will be ignored.
- **The Block length can be set individually for each of the 32 Blocks.**
- **The Block length can be changed at anytime by adjusting the End Marker in the Blocks view.**

## Changing Block color

Selecting separate colors for your blocks can be useful when you arrange your blocks in the Song View later on. All 32 Blocks already have default colors but these can easily be changed:

- **Select a color from the Block Color palette on the Blocks Track context menu or from the Edit menu.**  
This applies the selected color to the Block. The sequencer tracks and any clips in the Block will maintain their original colors.

## Recording in the Block View

Recording on tracks in the Block View is done in the same ways as when recording in the regular Song View.

! **Any events or recordings to the right of the End Marker in the Block View will be ignored when the Block is played back in the Song View.**

Refer to “Recording in the Sequencer” for details about recording.

## Editing clips in the Block View

Editing events in clips in the Block View is done in the same way as when editing clips in the Song View.

- **Double-click desired clip to open it for editing in Edit Mode, or click the Edit Mode button in the Toolbar.**  
Refer to “Note and Automation Editing” and “Audio Editing in the Sequencer” for details about editing clips.

## Arranging clips in the Block View

Arranging clips in the Block View is done in the same ways as when arranging clips in the Song View.

**! Any clips, or parts of clips, to the right of the End Marker in the Block View will be ignored when the Block is played back in the Song View.**

Refer to “Arranging in the Sequencer”.

## Arranging Blocks in the Song View

Once you are finished with your clips on the tracks and lanes in the Block View, it is time to arrange the Blocks to build up your song in the Song View. Setting up the Blocks and their playing order is done by creating Block Automation Clips on the Blocks Track in the Song Arrange view.

The following section describes functions and routines that are specific to Block Automation Clips. General clip handling procedures (e.g. naming, coloring etc.) are described in the general “Clip handling” section.

## Creating Block Automation Clips

A Block Automation Clip is very similar to a Pattern Clip (for a Redrum device, for example). A Block Automation Clip defines which Block should play back, and for how long. To create Block Automation Clips, proceed as follows:

1. Click the **SONG** button to switch to the Song View.

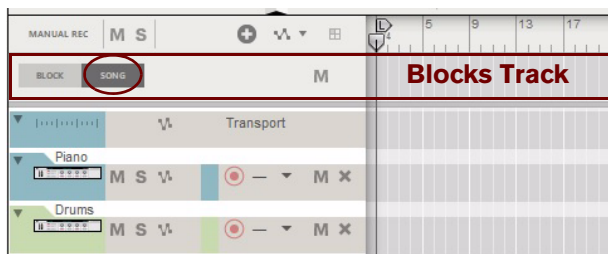

2. Select the Pencil tool.

The Block selector appears in the Inspector:



3. Select desired Block (1-32) from the Block Selector List.

In this example, we will use Block 1.

#### 4. Draw a clip on the Blocks Track.

This creates a Block Automation Clip which instructs the sequencer to play back the events you have previously recorded in Block 1:

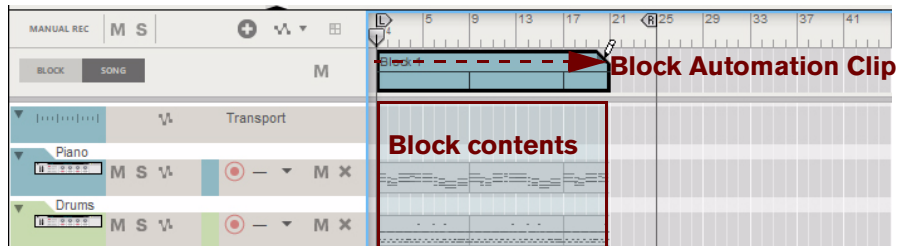

*A Block Automation Clip drawn on the Blocks Track in the Song View.*

The contents (clips and events) of Block 1 are displayed on the respective sequencer tracks in a ghosted fashion on a colored background. This way you will see what events and/or recordings the Block will play back. This also allows for muting of individual lanes in the Block (see “Muting lanes in Block Automation Clips”).

The following rules apply to Block Automation Clips:

- **If the Block Automation Clip is longer than the actual Block length (defined by the End Marker in the Block View), the Block is repeated over and over for as many times as necessary.**  
In the picture above, the Block length is 8 bars and the Block Automation Clip is 20 bars. This means that Block 1 is repeated at bars 9 and 17. The repetitions are indicated with thin vertical lines in the Block Automation Clip and on the sequencer tracks (similar to a Pattern Automation clip).
- **If the Block Automation Clip is shorter than an even multiple of the Block length, the remaining content of the Block is masked out (muted) in the Song View arrangement.**  
In the picture above, the last 4 bars of the third repetition are masked out.
- **If you want to add single Block Automation Clips, you can also double click with the Selection (Arrow) tool on the Blocks Track.**  
The clip gets the length of the currently selected Snap value. To create longer clips, double click, hold and drag to the right.

## Resizing Block Automation Clips

As with other clip types Block Automation Clips can be resized by clicking and dragging the clip handle(s) with the Selection (Arrow) tool or by editing the Position and Length values in the Inspector.

- **If you resize a Block Automation Clip by clicking and dragging its left clip handle, and thus changing its start position, the Block Offset will change.**

This means that the Block Automation Clip could start playing in the middle of the Block, i.e. not from the beginning. The picture below shows a Block Automation Clip before and after resizing the start position:

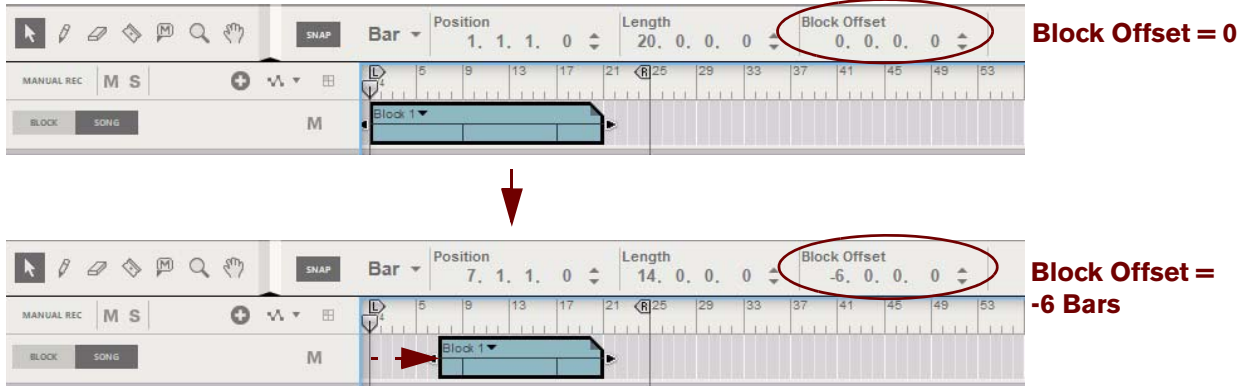

*Changing the start position by resizing a Block Automation Clip*

In the example above, the Block Automation Clip will begin playing at Bar 7, and will start playing back the events that began at Bar 7 in the Block.

- **If a Block contains sequencer tracks that use Pattern Automation (a Redrum track, for example), a Block Offset will make the pattern start playing back from the correct position within the pattern and sound just as you would expect.**

## Reassigning Blocks in Block Automation Clips

- **To assign another Block to an existing Block Automation Clip, click the small triangle button on the Block Automation Clip and select another Block from the drop-down list:**

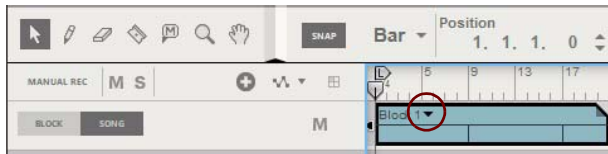

The Block Automation Clip color changes to the color of the new Block and the ghosted clips on the tracks switch to show the contents of the new Block.



## Muting lanes in Block Automation Clips

When you have arranged your Block Automation Clips as desired on the Blocks Track, it is possible to mute individual lanes contained in any Block. These lanes will remain muted until the end of the Block Automation Clip.

This way you can use the same Block to create a song intro, by gradually introducing more and more sequencer tracks/lanes. The example below shows how to mute lanes in individual Block Automation Clips to create a song intro.

We are going to use one single Block - Block 1 - to create a song intro. The Block is 8 bars long and uses four sequencer tracks. In the Block View we have recorded on all four sequencer tracks:

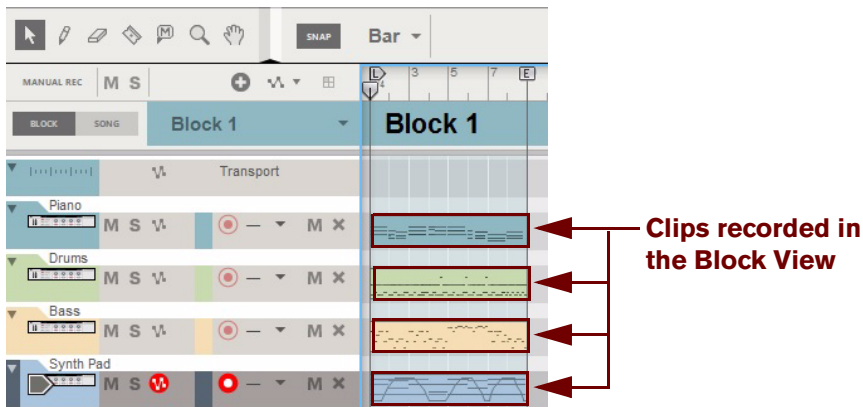

*Block 1 in the Block View with four sequencer tracks.*

Now, we want to arrange our song so we switch to the Song View and draw an 8 bar Block Automation Clip on the Blocks Track:

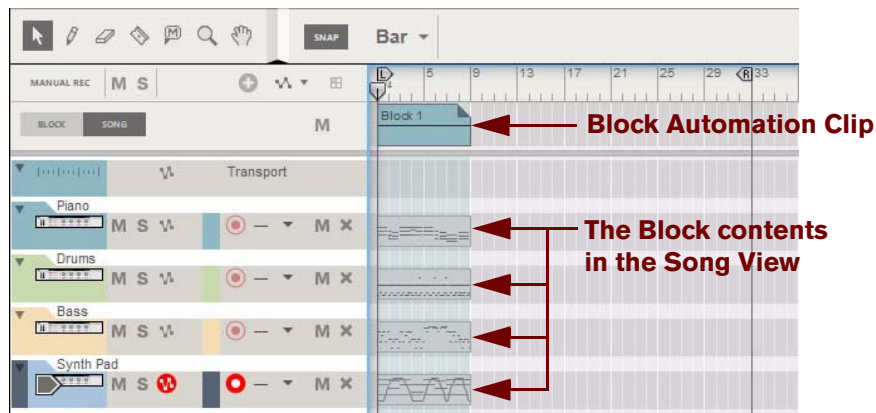

*An 8 bar Block Automation Clip assigned to Block 1.*

In our intro we want the Piano and Bass track to play the first eight bars. In the next eight bars we want to have the drums playing as well. Then, we want the song to continue for another 16 bars with all tracks playing except the Piano track.

To achieve this, we need to create several Block Automation Clips that play back the same Block. This is because when we're going to mute lanes later on, we need to define for how many bars we want the mutes to be active. The duration of the mutes are defined solely by the lengths of the Block Automation Clips.

We begin by copying and pasting the Block Automation Clip twice. Then we resize (expand) the last Block Automation Clip to 16 bars:

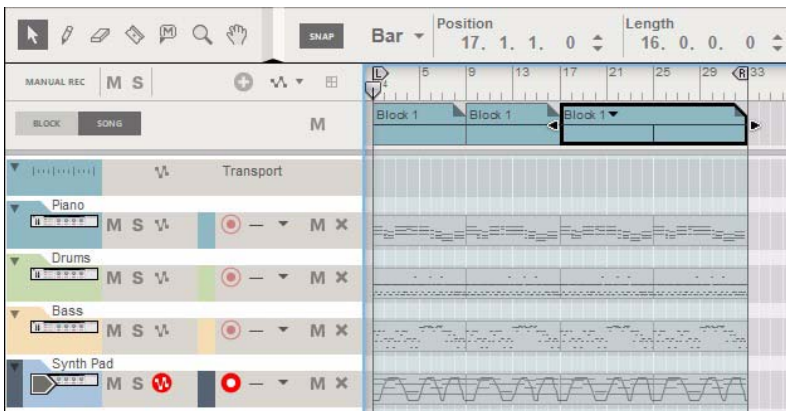

The Block Automation Clip assigned to Block 1 copied and pasted twice, with the last Block Automation Clip resized to 16 bars.

Now, we want to mute individual lanes for the duration of each Block Automation Clip to create our intro. We select the Mute tool from the Toolbar and click on the lanes we want to mute in each Block Automation Clip:

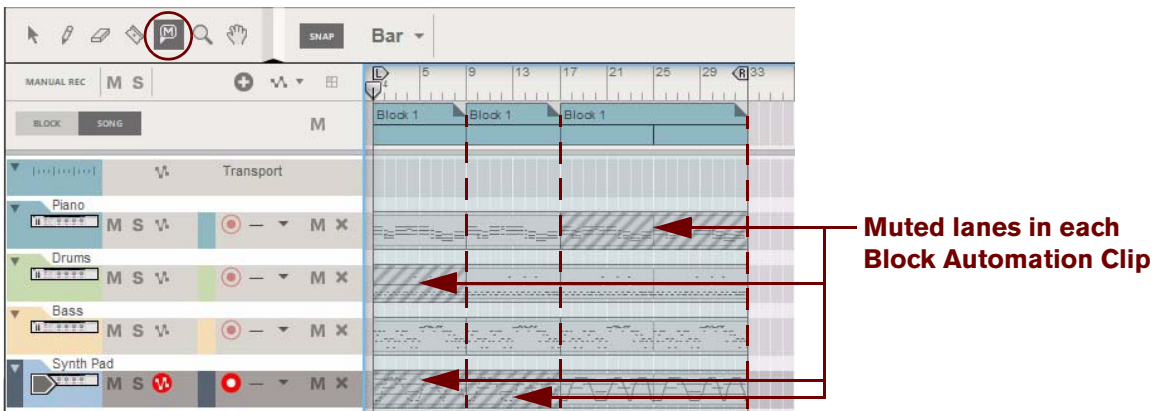

Muted lanes throughout the length of each Block Automation Clip.

Now, we have our intro with the Piano and Bass playing the first 8 bars. Then, the song continues for another 8 bars with Piano, Bass and Drums. Finally the song plays another 16 bars with Drums, Bass and Synth Pad. All we needed for this intro was one single 8 bar Block.

- ! **Note that the lanes will be muted for the duration of each Block Automation Clip. If the Block contents are repeated in the Block Automation Clip, as in the last clip above, the lane will be muted throughout the entire Block Automation Clip length. If you resize a Block Automation Clip, any muted lanes will be resized accordingly.**

# Converting Block Automation Clips to Song Clips

After you have arranged your Block Automation Clips in the Song View, you might want to convert the content of the Block(s) to “regular” clips on the sequencer tracks and lanes. There are a few ways of doing this:

## Converting single Block Automation Clips to clips in the Song View

1. Choose the Block Automation Clip(s) you want to convert by selecting it on the Blocks Track.
2. Select “Convert Block Automation to Song Clips” from the Edit menu or Block Clip context menu.  
All unmuted clips in the Block(s) are automatically converted to regular clips on the tracks. The Block Automation Clip and its contents are preserved and left unchanged:

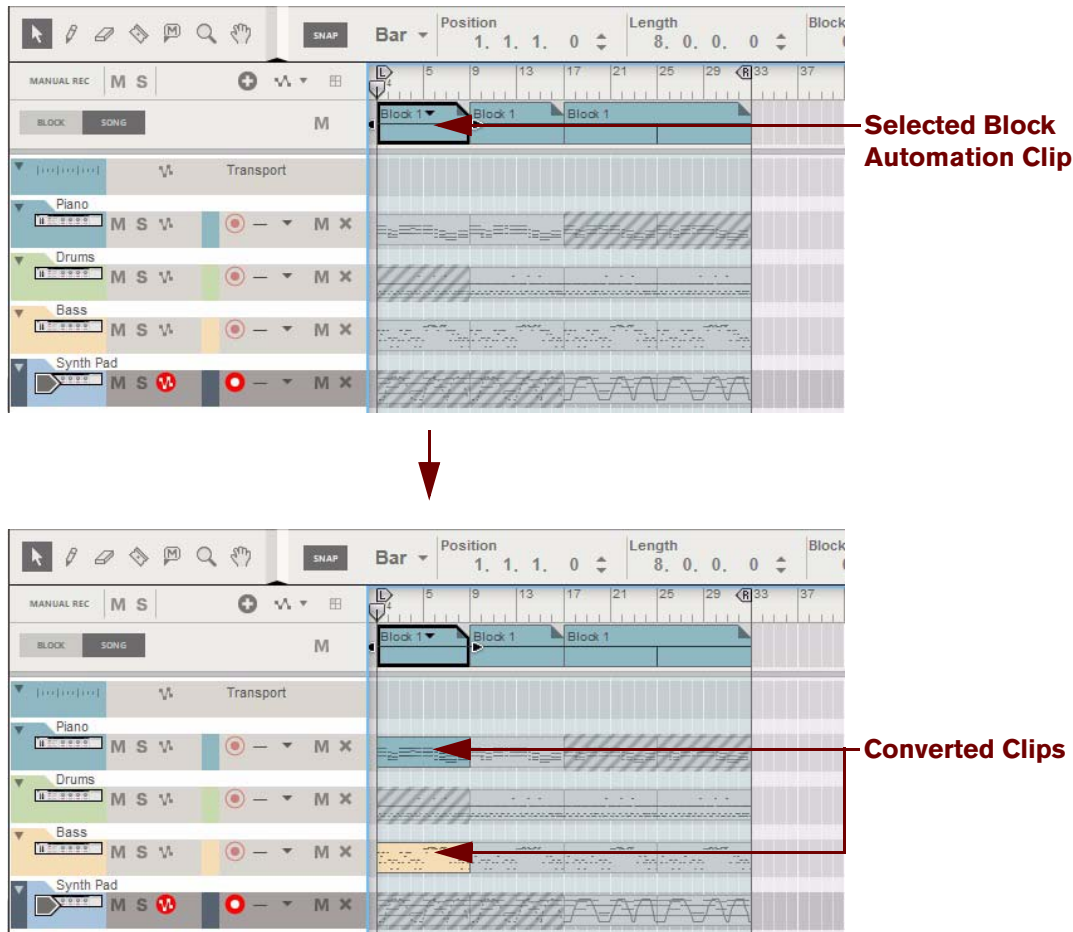

Before and after the “Convert Block Automation To Song Clips” command used on the first Block Automation Clip.

## Converting all Block Automation Clips to clips in the Song View

- Select **“Convert Block Automation to Song Clips”** from the **Track List** context menu.

All unmuted clips in all Block Automation Clips are automatically converted to regular clips on the tracks. The Block Automation Clips and their referenced Block contents still are preserved but the Blocks Track is automatically muted. This is made to reduce the clutter on the arrangement pane:

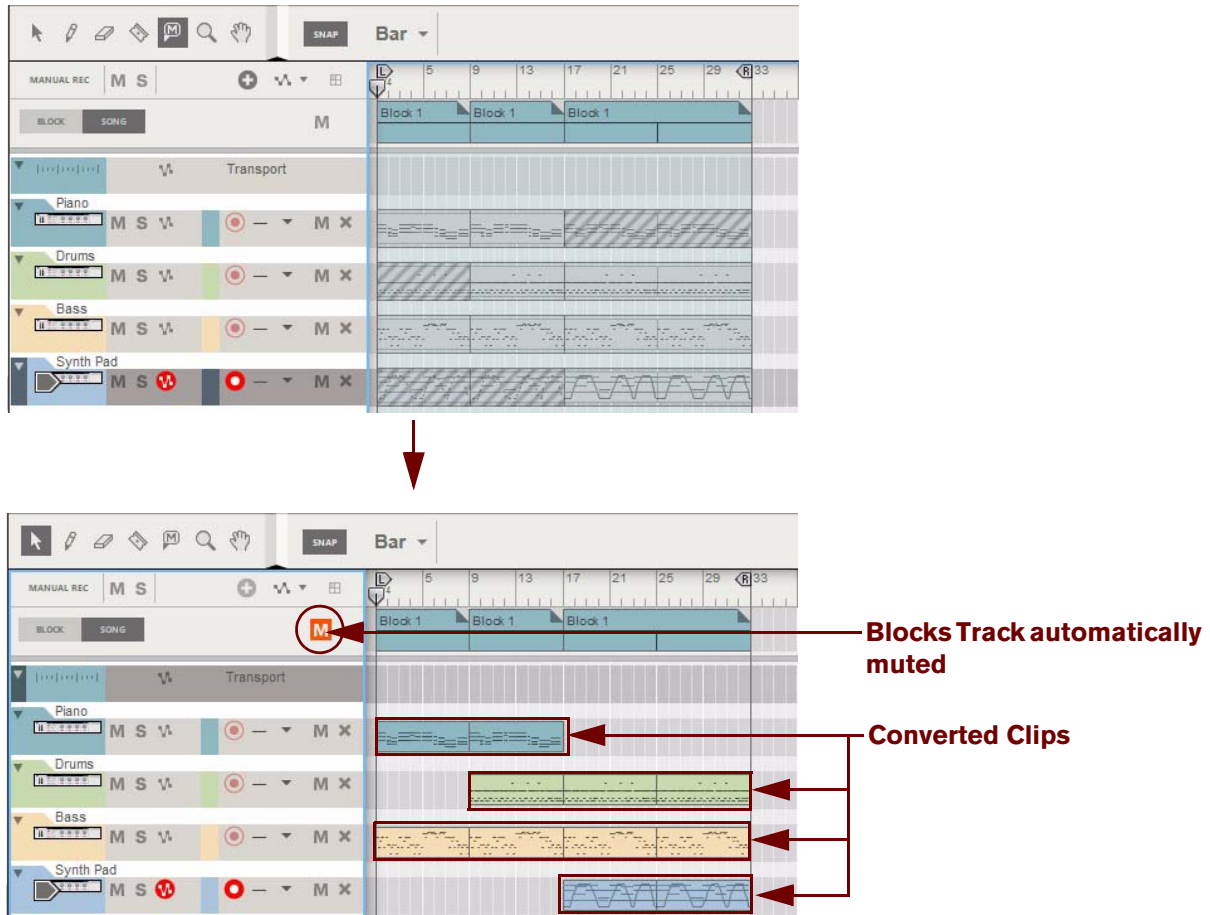

*Before and after the “Convert Block Automation To Song Clips” command used in the Track List*

- If you want to activate the **Blocks Track** again, click the **“M”** button on the **Blocks Track**.

## Using Cut/Copy and Paste for individual clips

You can of course also use the standard Cut/Copy & Paste functions to copy clips from the Block View to the Song View, and vice versa.

1. Select the clip(s) on the arrangement pane (in **Blocks** or **Song View**).
2. Use the standard **Cut** or **Copy** command.
3. Switch to the other **View** (**Song** or **Blocks**)
4. Use the **Paste** command.

## Combining Block Automation Clips with Song Clips

It's possible to combine Block Automation Clips with regular clips in the Song View. The general rule is that clips in the Song View have priority over Block data. This means that if a clip in the Song View overlaps a (ghosted) clip on the same lane in a Block, the Song Clip will play back and the clip in the Block "underneath" will be silent (masked):

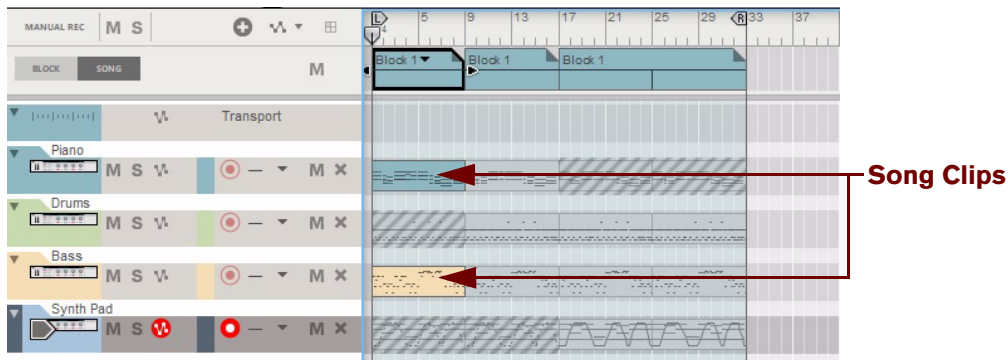

*Song clips and Block Automation Clips in combination in the Song View.*

If we play back the song in the picture above, this is what we will hear:

- **In Bars 1-8 the song clips on the Piano and Bass tracks will play. Any Block data "underneath" these clips will be silent.**
- **In Bars 9-16 the Block data for the Piano, Drums and Bass tracks will play back since there are no overlapping Song Clips.**
- **In Bars 17-32 the Block data for the Drums, Bass and Synth Pad tracks will play back since there are no overlapping Song Clips.**

## Practical tips on combining Blocks and Song Clips

A nice way of working with Block Automation Clips and Song Clips is to first create a couple of Blocks in the Block View and then arrange Block Automation Clips in the Song View. When you have arranged your Block Automation Clips, you could record a couple of shorter Song Clips with variations in the Song View. Then, place these short clips at desired positions in the arrangement to create nice variations in the song, according to the example below:

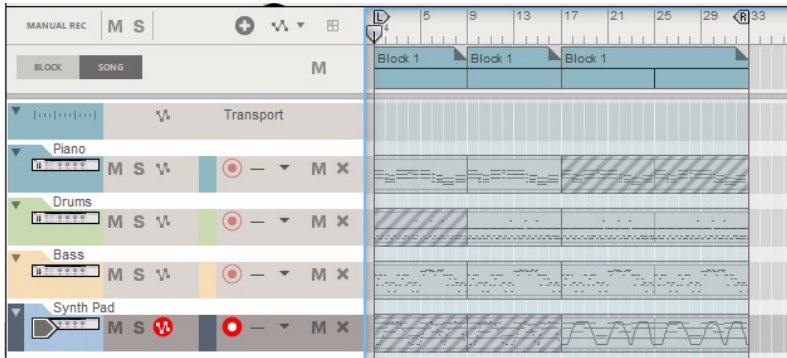

**Basic arrangement with only Block Automation Clips**

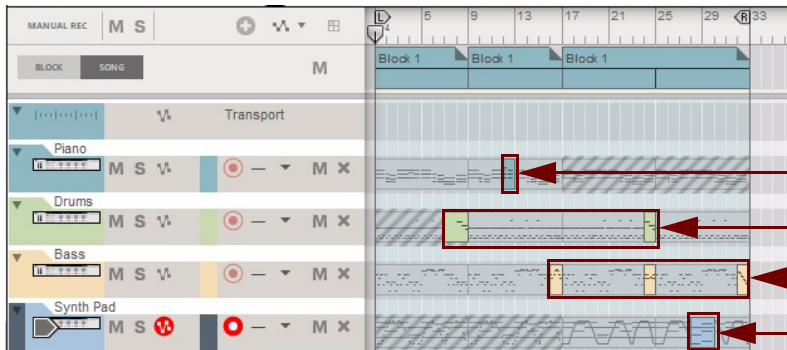

**Song Clips overlap to create variations in the arrangement**

*Short Song Clips combined with Block Automation Clips in the Song View to create nice variations.*

- Since Song Clips automatically mute (mask) the “underlying” Block data, short Song Clips are perfect for introducing temporary variations in a Block based song.

## About Performance Controllers and Parameter Automation

Since the sequencer tracks and lanes are shared between the Blocks and the Song arrangement, the following rules apply regarding Performance Controller and Parameter Automation:

- **Performance Controller and Parameter Automation data in the Song View arrangement always overrides automation in Blocks.**
- **If a sequencer track uses Parameter Automation in the Block, the automation will also affect all clips on the corresponding lanes in the Song View.**

The picture below shows a piece of an arrangement with an instrument track which has one note lane and one parameter automation lane. The arrangement is built up by Blocks (the ghosted data) and one short Song Clip for variation in bars 28 through 29 (the blue clip on the note lane). The Block uses Mod Wheel Performance Controller automation (the gray line inside the note clips in the Block) and automation of the Rotary 4 parameter (the gray line in the parameter automation clips in the Block):

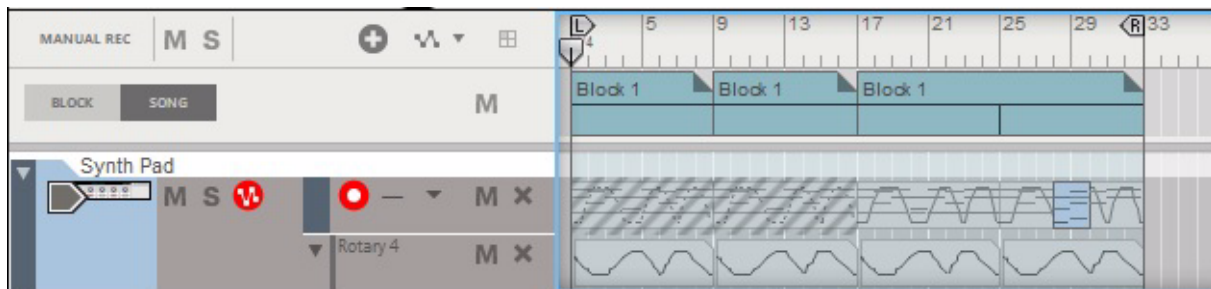

- **The song only plays Block data from the start to bar 28.**  
During this time, the Rotary 4 automation is active. (However, no notes are played back in bars 1 through 16 since the note lane in the Block is muted.)
- **At bar 17 the note lane is played back together with the Mod Wheel Performance Controller data in the Block.**  
The Rotary 4 automation is still active.
- **At bar 28 the (blue) Song Clip takes over the note playback and Mod Wheel Performance Controller automation.**  
Since the Mod Wheel isn't touched at all in the Song Clip, its value is set to zero. However, note that the Song Clip is still affected by the Rotary 4 automation in the Block!
- **At bar 30 the note clip in the Block takes over again and controls note playback and Mod Wheel Performance Controller automation.**  
The Rotary 4 automation is still active.





# **Chapter 11**

## **Working with the Rack**

# About this chapter

This chapter describes the procedures and techniques for managing devices and Device Groups in the rack.

## Rack device procedures

The rack is where you create and configure your devices, and make parameter settings. This section describes all the procedures for managing the rack, that is, procedures and techniques common to all devices.

## Navigating in the rack



The rack, here with three rack columns visible.

The rack houses all the devices you use in your song. To make it easier to overview the devices, the rack can contain several rack columns next to each other. To navigate in the rack, use one of the following methods:

- **Click and drag the blue frame in the Rack Navigator to scroll continuously in the rack, both vertically and horizontally.**  
Just clicking in the Rack Navigator will directly scroll to the corresponding position in the rack.
- **If you're using a mouse equipped with a scroll wheel, you can use it to scroll up or down in the rack.**  
Hold down [Shift] and use the scroll wheel to scroll horizontally in the rack.
- **Press the [Page Up] and [Page Down] buttons on the computer keyboard to move the view one "full screen" up or down in the rack column currently in view.**  
Note that the rack area must have Edit Focus, i.e. there must be a frame surrounding the rack area. Set Edit Focus by clicking anywhere in the rack area.
- **Press the [Home] and [End] buttons on the computer keyboard to scroll the top or bottom of the rack column currently in view.**  
Note that the rack area must have Edit Focus.
- **When you select a track in the sequencer, or click the "Rack" button below a channel strip in the Main Mixer, the rack will automatically scroll to bring the associated device into view.**

# Resizing and detaching the rack



- **Resize the rack area by clicking and dragging either of the gray horizontal headers above or below the rack area, or by dragging the vertical Browser divider.**  
This will shrink the Main Mixer and/or sequencer areas and make more of the rack visible.
- **You can also resize the Rack Navigator area by clicking and dragging the vertical divider to the left of the Rack Navigator.**  
Dragging the divider to the left will expand the Rack Navigator area and enlarge the devices, making it easier to get a good overview of all devices in your rack.
- **To make the rack fill the entire song document window, press [F6] or double click the gray Rack header:**



*The rack header.*

- **To toggle between show and hide rack, click the Show/Hide icon to the left on the gray rack header:**



*The Show/Hide icon on the rack header.*

- **You can detach the rack area from the other areas altogether by holding [Ctrl](Win) or [Cmd](Mac) and pressing [F6], or by clicking the “Detach” icon in the gray rack header.**  
This will place the rack in a separate window. (See “The Rack” for more info.)

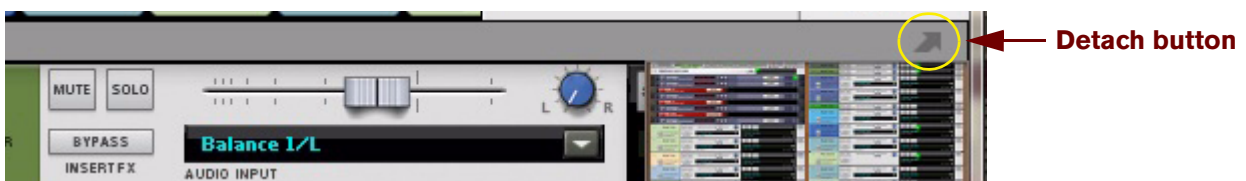

*The rack Detach icon.*

- See also **“Creating new rack columns”** for information on how to create several rack columns.

## About using the Browser in the detached rack

When the rack is detached, it also features a second instance of the Browser. The Browser is available to the left in the detached rack.

→ **Click the Show/Hide icon, or press [F3] to bring up the Browser (or to hide it):**



*The Show/Hide icon on the Browser header in the detached rack.*

- **The Browser in the detached rack can be navigated independently from the Browser in the Song window, except only one can have browse focus at a time (see “Setting browse focus”).**

This means you can be in two completely different locations (or palettes) in the two Browsers.

## About Device Groups

A Device Group is a series of interconnected devices that “belong together”. A Device Group could be, for example, an instrument device connected to an effect device and then to a Mix Channel device.

A Device Group consists of the following:

- **One (and only one) Source device (e.g. an instrument).**
- **The devices to which the Source device feeds its audio signals (e.g. and effect device).**
- **Any CV-only devices (a Matrix Sequencer, for example) that are CV-connected to devices in this group only.**
- **All sequencer tracks and Main Mixer channel strips for the devices in the group.**
- ! **A Device Group is only defined by the connections between the devices - it has nothing to do with the physical location of the devices in the rack.**

By default, when you create an Instrument device, a new (or currently unused) Mix Channel device will be automatically connected to the Instrument device, as described in “Creating devices”. In this situation, the Instrument device and the connected Mix Channel device will now be considered a Device Group - with the Instrument device as the Source device.

If you want to keep all devices in a Device Group physically together in the rack (e.g. if you want to move all devices in the group), there is an option “Auto-group Devices and Tracks” on the Options menu.

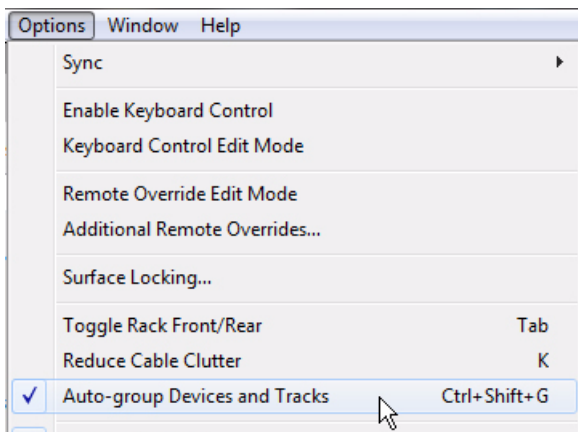

The “Auto-group Devices and Tracks” option.

The advantage of using the “Auto -group Devices and Tracks” option is that it’s much easier to get a good visual overview over what devices are connected to each other and associated with specific sequencer tracks and with a specific channel strip in the Main Mixer. It’s also easier to rearrange devices in the rack since all devices in the Device Group will move together if one device in the Device Group is moved.

The example below shows two ID8 devices connected to one Mix Channel device each. Let’s say you want to move the ID8 1 device to another position in the rack. This is what will happen:

1. Make sure “Auto-group Devices and Tracks” is selected on the Options menu - if not, select it from the menu or hold down [Ctrl]+[Shift](Win) or [Cmd]+[Shift](Mac) and press [G].
2. Click on the ID8 1 device panel (but not on a parameter or display) and drag and drop below the ID8 2 device in the rack.

As you can see, both the ID8 1 device and its connected Mix Channel device are moved together, as a group, to the new destination.

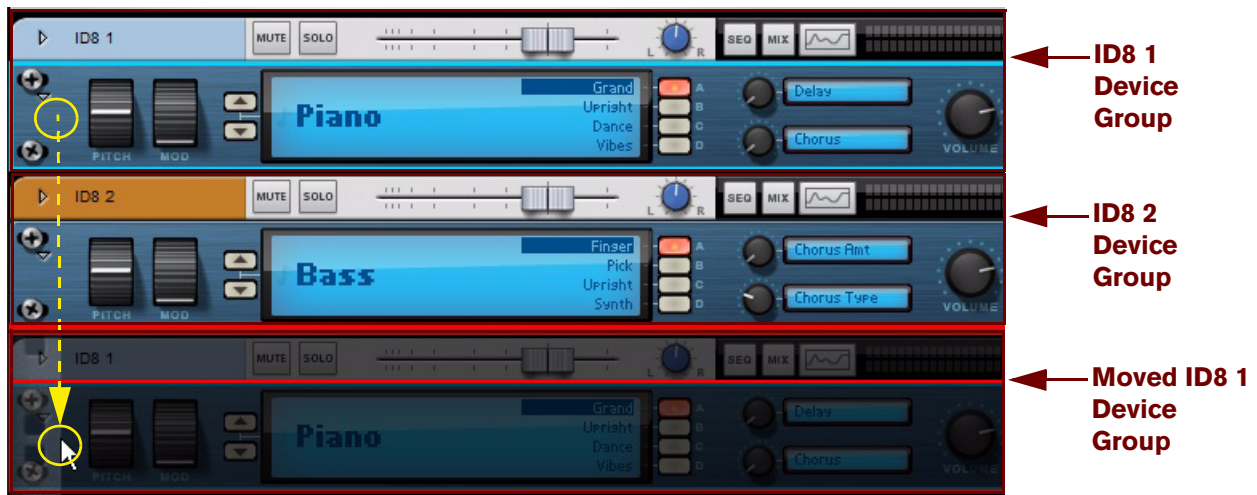

- If you want to view what devices belong to a specific Device Group, select a device and then select “Select All in Device Group” from the Edit menu or context menu.

# Creating devices

Devices can be created in a number of different ways. These first methods apply to any device types:

→ **Use drag and drop, or double-click a device in any of the device palettes in the Browser.**

The devices are sorted in three different groups: Instruments, Effects and Utilities. The Utilities group contains device types such as mixers, modulation devices, etc. In each device type group the devices are listed in the following sections: Reason Devices, and then by Rack Extension manufacturer in alphabetical order.

A device can be dropped in the rack or in the Track List in the Sequencer. As you drag a device to the rack or Sequencer Track List, a + sign is shown together with an orange divider to indicate where the device will be placed:



*Adding a PX7 FM Synthesizer device by dragging from the Instruments device palette and dropping in the rack.*

→ **Use drag and drop from the Browser, Windows Explorer (Win), Finder (Mac), or double click a patch in the Browser.**

When you drop a patch in the rack or in the Track List in the Sequencer the corresponding device is automatically created in the rack.

→ **Select desired device from the “Create” menu.**

Any device type can be created. The “Create” menu is available both on the main menu and on the rack and device context menus and is divided into the three groups Instruments, Effects and Utilities. At the top of each group (Instruments/Effects/Utilities) are the devices you create most often. Below are all available devices, on submenus per manufacturer.

• **When you have created an Instrument or Effect device that can load patches, it automatically gets “browse focus” (orange indicators). This means that the Browser automatically displays patches for the device you just created. See “Loading patches” for more information.**

Automatic browse focus can be switched off if you like. This is done on the General tab in Preferences, see “New devices get browse focus”.

• **When you add a new device, Reason attempts to automatically route it in a logical way.**

For more information about the auto-routing features, see “Automatic routing”.

Depending on what type of device you’ve created, and also the “Auto-Group Devices and Tracks” setting, the results will differ:

• **If “Auto-Group Devices and Tracks” on the Options menu is not selected, the new device is added directly below the currently selected device in the rack.**

If no device is selected, the new device is added at the bottom of the rack.

• **If “Auto-Group Devices and Tracks” on the Options menu is selected, devices will not be created in the middle of existing Device Groups (except if they are effect devices - see “Effect devices specifics”).**

This means a device might not end up below the selected device in the rack, but below that device's Device Group.

! **See below for information specific to certain device types.**

## Instrument device specifics

The following additional methods can be used for creating Instrument devices:

→ **Select “Create Instrument...” from the Create menu.**

This will show the Instruments palette in the Browser. Here you can choose the Instrument device you want to create - see [“Create Instrument/Create Effect”](#).

- **If you have created an Instrument device, a new sequencer track will be automatically created. Also, a new (or unused) Mix Channel device will be connected to the Instrument device. The Mix Channel device’s channel strip will appear in the Main Mixer.**

The track, the Mix Channel device and its channel strip will be given the same name as the created Instrument device. Master Keyboard Input will also automatically be set to the new track, allowing you to immediately play the created Instrument device via MIDI (see [“Master Keyboard Input”](#)). By default, the Instrument device and Mix Channel device will be treated as a “Device Group” from here on (see [“About Device Groups”](#)).

- ! **By default, the automatic creation of a sequencer track and Mix Channel device only applies to instrument devices, not to mixers or effect devices.**
- **If you hold down [Alt](Win) or [Option](Mac) when you create an Instrument device (except when you drag and drop from the Browser), a sequencer track will not be created.**
- **If you hold down [Shift] when you create an Instrument device, there will be no automatic routing or connections made.**

## Audio Track device specifics

The following additional methods can be used for creating Audio Track devices:

→ **Select “Create Audio Track” from the Create menu.**

This will create an Audio Track device (with its corresponding channel strip in the Main Mixer) and a sequencer track.

## Mix Channel device specifics

- **If you hold down [Alt](Win) or [Option](Mac) when you create a Mix Channel device (from the Create menu or Browser), a sequencer track will be created for the device.**

## Effect devices specifics

The following additional method can be used for creating Effects devices:

→ **Select “Create Effect...” from the Create menu.**

This will show the Effects palette in the Browser. Here you can choose the Effect device you want to create - see [“Create Instrument/Create Effect”](#).

The results when creating Effect devices depend on the following criteria:

- **If an Audio Track (device or channel strip), or a Mix Channel (device or channel strip), was selected in the rack when you created an effect, the effect device will be added and connected as an insert effect, inside the Insert FX container for that Audio Track or Mix Channel device.**
- **If an Instrument device was selected in the rack when you created an effect device, the effect device will be added and connected as an “insert effect”, between the Instrument device and the Mix Channel device.**
- **If a Mixer 14:2 or Line Mixer 6:2 was selected in the rack when you created an effect, the effect device will be added and connected as a Send Effect, on the first available Send FX connectors of the mixer device.**
- **If you hold down [Alt](Win) or [Option](Mac) when you create an effect device, a sequencer track will be created for the device.**
- **If you hold down [Shift] when you create an effect device, the effect device will not be connected.**

## Mixer device specifics

- If you hold down [Alt](Win) or [Option](Mac) when you create a mixer device, a sequencer track will be created for the mixer device.
- If you hold down [Shift] when you create a mixer device, it will not be connected to a Mix Channel device.

## Selecting devices

Some operations, e.g. cutting, copying, moving and deleting devices (see “Cut, Copy and Paste devices” and “Deleting devices”), require that you select one or several devices in the rack. This is done according to the following:

- **To select a single device, click on it in the rack.**

The selected device is displayed with a colored border (based on the color scheme selected for your operating system).

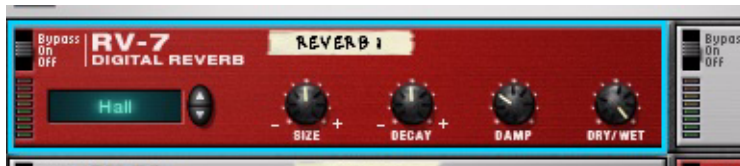

- **To select several devices, hold down [Shift] and click on the desired devices.**  
In other words, [Shift]-clicking a device selects it without de-selecting any other selected devices.
- **To de-select all devices, click in the empty area at the bottom of, or next to, the rack.**
- **To de-select a device in a multiple selection, hold down [Shift] and click on it.**  
All other selected devices remain selected.
- **You can also use the arrow keys on the computer keyboard to select the device directly above, below or next to the currently selected one.**  
When you use this method, Reason will automatically scroll the rack so that the selected device is fully visible. This is a quick way of “stepping through” the rack. Narrow devices (e.g. half-width devices such as some effects) are ordered left-to-right, i.e. pressing the down arrow key will step through the devices from left to right before moving on the next device row.
- **If you hold down [Shift] when using the up or down arrow keys, the currently selected device will remain selected.**  
This allows you to select a range of devices.
- **Adjusting a parameter in a device will automatically select the device.**  
In other words, you don't have to select a device as a separate operation before editing its parameters.

## Playing devices from the rack

When you create an instrument device it automatically gets a corresponding sequencer track, and Master Keyboard Input is set to that track so you can play the instrument device from your MIDI keyboard. You can change Master Keyboard Input by selecting another sequencer track, but you can also change Master Keyboard Input from the rack. This is useful if you, for example, have the rack detached and maximized, so you can't see the sequencer area.



When you select a device in the rack it is surrounded by a colored border. At the top left of the border is a Master Keyboard Input tab:



The Master Keyboard Input tab on a selected ID8 device in the rack.

- **Click the Master Keyboard Input tab to automatically set Master Keyboard Input to the device.** Master Keyboard input is automatically switched in the sequencer as well and you can now play the device from your MIDI keyboard:



Master Keyboard Input set from the ID8 1 device in the rack.

When you play the device, incoming MIDI is indicated by the Master Keyboard Input symbols on the device in the rack as well as on the sequencer track.

- **If a selected device doesn't have a sequencer track (e.g. effect devices), one will be automatically created if you click the Master Keyboard Input tab.**

## About selecting all devices in a Device Group

To select all devices in a Device Group, do as follows:

- 1. Select any device in the desired Device Group.**
- 2. Select “Select All in Device Group” from the Edit menu or context menu.**  
All devices in the Device Group will be selected as indicated by the colored borders around the devices.

## Deleting devices

To delete one or several devices, select them in the rack and use one of the following methods:

- **Press [Backspace] or [Delete].**  
An alert appears asking you to confirm the deletion. Any cable connections to the device will also be deleted (or re-routed).
- ! **If you have selected a Source device or a Mix Channel device and the “Auto-Group Devices and Tracks” on the Options menu is selected, an alert appears asking if you want to delete the device or the whole Device Group, including sequencer tracks and channel strips. (See “About Device Groups”).**
- **To delete devices or Device Groups without alerts, hold down [Ctrl](Win) or [Cmd](Mac) and press [Backspace] or [Delete].**
- **Select “Delete Devices and Tracks” from the Edit menu or the device context menu.**  
An alert appears asking you to confirm the deletion. This will delete the devices together with the associated sequencer track(s) also if the “Auto-group Devices and Tracks” option isn’t selected. (It’s possible to have devices without associated tracks but it is not possible to have a sequencer track without an associated device.)
- **To delete devices and tracks without alerts, hold down [Ctrl](Win) or [Cmd](Mac) before selecting “Delete Devices and Tracks” from the Edit menu or the device context menu.**
- ! **If you delete a device connected between two other devices, the connection between the two other devices is automatically preserved.**
- ! **The Reason Hardware Interface and the Master Section device at the top of the rack cannot be deleted.**

## Re-ordering devices

If you want to move an instrument device to another position in the rack, you probably also want its Mix Channel device and connected effects to move along with it. If the “Auto-group Devices and Tracks” on the “Options” menu is selected, all devices in the Device Group will follow along when you drag and drop a device included in a Device Group. However, it’s still possible to re-order devices within each Device Group. See “About Device Groups” for more details. See also “About the “Sort Selected Device Groups” function” for information about automatic sorting of several Device Groups.

If the “Auto-group Devices and Tracks” on the “Options” menu is not selected, you can re-order and move devices individually in the rack - even outside the Device Groups:

- 1. If you want to move more than one device at the same time, [Shift]-click the devices to select them.**
- 2. Click on the panel of one of the devices (but not on a control or display).**
- 3. With the mouse button pressed, drag the device(s) to the new destination in the rack.**  
An orange line indicates where the device(s) will be positioned. Note that when re-ordering devices with smaller width, the line can be to the left of a device (indicating that the moved device will be placed before the other device) or to the right of a device (indicating that the moved device will be placed after the other device).

- It's also possible to move devices to a new rack column to the left or right of the original rack (see **“Creating new rack columns”**).

In this example an RV-7 reverb device is moved to two different destinations:

*In this case, the line indicates that the RV-7 reverb device will be placed to the left of the phaser.*



*This is the result. Note that the filter device is moved to the left, to fill out the gap.*



*In this case, the line indicates that the reverb device will be placed to the right of the chorus/flanger.*



*This is the result. All three devices are moved to the left, to fill out the gap.*



#### 4. Release the mouse button.

The device(s) are moved to the new position and the other devices in the rack are adjusted to fill up the gap(s).

- ! **Note that if you start to move a device but change your mind, you can abort the operation by pressing [Esc] while keeping the mouse button depressed.**
- ! **Moving devices in the rack does not affect the order of the sequencer tracks or channel strips and vice versa. If you want the sequencer tracks and channel strips to be re-ordered as well, see **“About the “Sort Selected Device Groups” function”**.**

## Re-routing devices

→ If you hold **[Shift]** and drag a device to a new position in the rack, it will be re-routed (as if you deleted it and created it in its new position).

This allows you to e.g. change the order of effect devices in a signal chain by Shift-dragging them.

See [“Automatic routing”](#) for more info on auto-routing.

## Creating new rack columns

It's possible to move devices, or Device Groups, to new rack columns. This is very useful if your rack starts to get crowded, or if you want to arrange your devices in separate rack columns to get a better overview.

By default, when you create a new empty Song document, the rack consists of a single rack column featuring the Reason Hardware Device and the Master Section device. When you create new devices from the “Create” menu, these will automatically be placed in that rack column.

By dragging and dropping devices to either side (left or right) of the original rack, you can move the devices and at the same time create a new rack column. You can create as many rack columns as you like - the only condition is that at least one device must be present in a neighboring rack column. In other words, you can't create empty rack columns.

In the example below, we drag and drop an RV7000 reverb device to the right of the original rack:

*Click on the RV7000 device panel and drag to the right...*

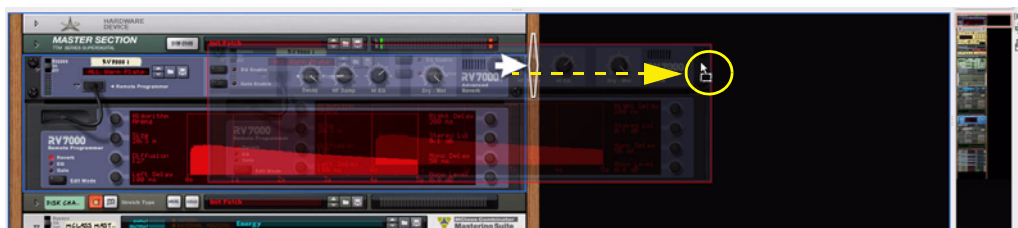

*... Release the mouse button and the RV7000 device is automatically placed in a new rack column to the right.*



A large white arrow symbol appears on the right wooden rack side of the original rack column to indicate that the device is about to be moved to a new rack column.

## About the “Sort Selected Device Groups” function

When you are working with Device Groups (see [“About Device Groups”](#)), there is a very nice feature which allows you to visually organize and re-order the Device Groups, Main Mixer channel strips and sequencer tracks. With the “Sort Selected Device Groups” function on the Edit menu, it's possible to sort Device Groups and Main Mixer channel strips according to the current sequencer track order - or vice versa, depending on what's currently selected. To sort the Device Groups in the rack, and the channel strips in the Main Mixer, according to the current sequencer track order, proceed as follows:

**1. Select a track in the sequencer Track List rack and choose “Select All” from the Edit menu or track context menu.**

Tracks are marked with darker colors to indicate they've been selected.

**2. Select “Sort Selected Device Groups” from the Edit menu or track context menu.**

Now all Device Groups and channel strips in the Main Mixer will be automatically re-ordered according to the current track configuration in the sequencer. The topmost sequencer track will have its associated Device Group moved to the top in the rack. The remaining Device Groups will be re-ordered according to the remaining track order in the Track List. The Main Mixer channel strips will also be re-ordered according to the sequencer track order.

- **If you have devices in several rack columns, the sorting will begin in the leftmost rack column and continue to the right through the rest of the rack columns. The number of devices in each rack column will not be changed.**
- **If you select several Device Groups in the rack and choose “Sort Selected Device Groups” from the Edit menu or device context menu, the tracks in the sequencer and the Main Mixer channel strips will be re-ordered according to the current Device Group order in the rack.**
- **If you select several channel strips in the Main Mixer and choose “Sort Selected Device Groups” from the Edit menu or channel strip context menu, the Device Groups in the rack and the tracks in the sequencer will be re-ordered according to the current channel strip order in the Main Mixer.**

## Replacing devices

If you want to replace an Instrument or Effect device in the rack with another device of the same category, proceed as follows:

**1. Bring up the Device Palette in the Browser for the desired device type (Instruments or Effects).**

**! Utility devices cannot be replaced using these methods!**

**2. Drag the desired device from the Device Palette to the rack and place on top of the device you want to replace.**

The device to be replaced is dimmed in orange and gets a “replace” symbol in the center:



*Replacing a Subtractor with a PX7 FM Synthesizer device.*

**3. Release the mouse button to replace the device in the rack.**

The new device is automatically routed like the previous device. The Mix Channel now also gets the name of the current patch in the new device. The new device also gets “browse focus” in the Browser, see “Loading patches”.

→ **You can also drag and drop devices on existing device icons in the Sequencer Track List. The result is exactly the same as dropping devices on existing devices in the rack.**

- You can also drag other device patches from the Browser, Windows Explorer or Finder (Mac) and drop on a device in the rack or Sequencer Track List to replace existing devices, see [“Loading patches”](#).
- ! Note that Instrument devices can only be replaced by other Instrument devices. The same goes for Effect devices.

## Duplicating devices

Duplicating devices will have different results depending on the “Auto-group Devices and Tracks” setting on the Options menu (see [“About Device Groups”](#)):

- To duplicate a device or a Device Group in the rack, hold down [Ctrl](Win) or [Option](Mac) and drag the device to a new position.
- If “Auto-group Devices and Tracks” is not selected, a copy of the selected device will be created without any connections.
- If “Auto-group Devices and Tracks” is selected, a copy of the entire Device Group will be created with all connections preserved. A new track will also be created in the sequencer.
- Select the device(s) and select **“Duplicate Devices and Tracks”** from the Edit menu or context menu.  
A duplicate (copy) of the device(s) or Device Group(s) will be created. New tracks for the device(s) or Device Groups will also be created in the sequencer.
- If you hold down [Shift] when you duplicate devices, Reason will attempt to automatically route them, just as when you move devices.  
See [“Automatic routing”](#).

## Cut, Copy and Paste devices

Selected devices or Device Groups can be moved or duplicated using the Cut, Copy and Paste Device functions on the Edit menu or device context menu. This allows you to copy one or several devices (such as an instrument device and all its “insert” effects) from one Reason Song document to another. Cutting/Copying and Pasting will have different results depending on the “Auto-group Devices and Tracks” setting on the Options menu (see [“About Device Groups”](#)):

- **Cut and Copy affects all selected devices or Device Groups, and works according to the standard procedures.**  
That is, Cut moves the devices/Device Groups to the clipboard (removing them from the rack) while Copy creates copies of the devices/Device Groups and puts these in the clipboard memory, without affecting the rack.
- **To Cut, Copy and Paste a Device Group, make sure the “Auto-group Devices and Tracks” is selected on the Options menu. Then, select a device in the Device Group and proceed with the Cut/Copy and Paste procedure.**  
All devices in the Device Group will be cut/copied and pasted with preserved connections (in the same Song or in another Song document).
- **When you Paste devices or Device Groups, these are inserted into the rack below the currently selected device.**  
If no device is selected, the pasted devices/Device Groups will appear at the bottom of the rack column.
- ! **As when creating devices, you cannot paste a Source device into an existing Device Group if “Auto-group Devices and Tracks” is on. It will be inserted below the Device Group.**
- **If you Copy and Paste several devices, any connections between these are preserved.**
- **If you hold down [Shift] when you Paste a device, Reason will attempt to automatically route it.**  
The rules are the same as when moving or duplicating devices by dragging and dropping. See [“Routing Audio and CV”](#) for more information about automatic and manual routing.

## Naming devices

Each device has a “tape strip” which shows the name of the device. When you create a new device it is automatically named according to the current patch in the device. Devices that don’t use patches are automatically named according to the device type, with an index number (so that the first ID8 device r you create is called “ID8 1”, the next “ID8 2” and so on). If you like, you can rename a device by clicking on its tape strip and typing a new name (up to 16 characters).



For instrument devices connected to Mix Channel devices, the device names are automatically copied to the tape strips for the corresponding Mix Channel devices and their channel strips in the Main Mixer, as well as on their corresponding sequencer tracks. Similarly, the names of the FX Returns in the Main Mixer show the names of the effect devices connected to the corresponding FX Return inputs.

- **When you create a device for which an associated sequencer track is created, the track in the sequencer will be assigned the same name as the device. Renaming the device will also rename the corresponding sequencer track, and vice versa.**
- **Note that the mixer channel tape strips always show the patch name (or device name) of the source device connected to the Mix Channel device! This means that if you have an instrument device routed through one or several effect devices, the Mix Channel tape strip will show the name of the instrument device (as this is the Source device).**
- **You can rename Mix Channels manually, for example, if you use multiple outputs from a sampler device going to separate Mix Channels. If you later delete the custom name, the Mix Channel will default to showing the Source device's name. For audio tracks, the Audio Track device is always the Source device and will never change name unless you manually rename it.**
- **If you delete your custom device name, the name reverts back to the default name, i.e. the patch name or device name (for non patch devices).**

## Folding and unfolding devices

If you don't need to edit the parameters for a device, you can fold the device to make the rack more manageable and to avoid having to scroll a lot.

- Click the “Fold/Unfold” button to the left of the device panel to fold the device.



The “Fold/Unfold” button on an RV7000 device.

- To unfold the device, click the “Fold/Unfold” button again.
- In rack rows containing devices of smaller width, the “Fold/Unfold” button is placed to the left of the leftmost device and affects all devices in the row:

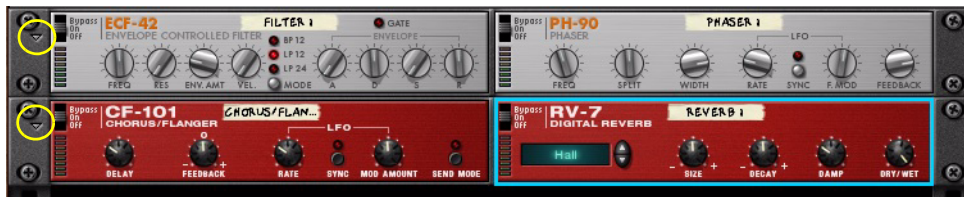

The “Fold/Unfold” buttons for devices of smaller width.

- Hold down [Alt](Win) or [Option](Mac) and click the “Fold/Unfold” button of an unfolded device to fold all devices in the current rack column.  
Conversely, hold down [Alt](Win) or [Option](Mac) and click the “Fold/Unfold” button of a folded device to unfold all devices in the current rack column.
- For folded devices, no parameters are shown and you cannot reroute any cables on the rear of the rack as long as the devices are folded.  
However, if you want to make a connection to a folded device, you can drag a cable to it and hold it there for a moment. This will cause the folded device to automatically unfold and let you make the connection.
- Folded devices can be renamed, moved, duplicated and deleted just like unfolded devices.
- For devices that use patches, you can select patches in folded mode as well.
- Playback is not affected by folding.



# **Chapter 12**

## **Working with Rack Extensions**

# About this chapter

This chapter describes the procedures and techniques for managing Rack Extension devices.

## What are Rack Extensions?

Rack Extensions are additional rack devices that can be purchased in the Propellerhead web shop at [shop.propellerheads.se](http://shop.propellerheads.se) and used together with the internal devices in the rack. Rack Extensions can be instruments, effects or utility devices, such as mixers and CV processors. Rack Extension devices are developed by Propellerhead as well as by 3rd party companies.

Rack Extension devices integrate fully with the Reason rack:

- **Cables can be connected on the rear panels, just like on the internal rack devices.**
- **CV signals can be routed like on the internal rack devices.**
- **Rack Extension devices are combinable with other Rack Extension and internal devices (see “The Combinator” chapter).**
- **Panel parameters are automatable and remotable.**

## Future compatibility

Rack Extensions are Windows and Mac-compatible and will work with any operating system and platform that Reason supports - now and in the future.

## Trying and buying Rack Extensions

### Trial versions of Rack Extensions

You can try out a Rack Extension by going to the Propellerhead web shop at [shop.propellerheads.se](http://shop.propellerheads.se) and using the "Try" function. This gives you a trial license which will last for 30 days. During this time, the Rack Extension is fully operational, but requires that you run Reason with Internet Verification, see “[Running Reason with Internet Verification](#)”.

When the trial license expires, the Rack Extension will be removed from the program menus. However, it will remain installed unless you manually uninstall it. Should you choose to purchase the Rack Extension later on, you don't need to download it again.

You can only try a Rack Extension once (one 30-day period).

### Buying Rack Extensions

When you purchase a Rack Extension, a license is automatically written to your Propellerhead user account on the Propellerhead web site. Just like with your Reason license, you can write a Rack Extension license to your authorized computer or Ignition Key hardware (or Propellerhead Balance audio interface). You can download and install the Rack Extension on as many computers as you like. However, to use the Rack Extension in Reason you either need your authorized computer, your Ignition Key hardware with the Rack Extension license on it, or an Internet connection to run with Internet Verification.

**! Rack Extension devices are not available when you run Reason in Demo Mode.**

If you move to another computer, you can download and install all your Rack Extensions by going to your user account on the Propellerhead web site (Your Products page, Rack Extensions tab) and clicking the "Sync All" button. This function is also excellent for making sure you got the latest versions and updates of all your Rack Extensions. Only files that are missing on your computer will be downloaded and installed.

Rack Extensions can be updated, with fixes and additions. Updates are posted on your Propellerhead user account page. An update can be free or paid. In both cases, the Rack Extension is backwards compatible, meaning that you can open older songs and patches and they will sound the same.

## Installing and managing Rack Extensions

Whenever you download and install a Rack Extension, from the web shop or your user account, this will be handled by an application called Authorizer. Authorizer is installed together with the Reason installation, and will automatically launch when you Buy, Try or Download a Rack Extension from the Propellerhead web shop.

Authorizer checks what's already installed on your computer, downloads any missing files and puts them in the correct locations.

**! Authorizer will automatically write Rack Extension licenses to your connected Ignition Key hardware and/or your authorized computer.**

If you want to check what Rack Extensions are installed on the computer, you need to launch Authorizer:

→ **Either select Rack Extensions from the Window menu in Reason or locate the Authorizer program on your computer and launch it manually.**

Authorizer lists all installed Rack Extensions:

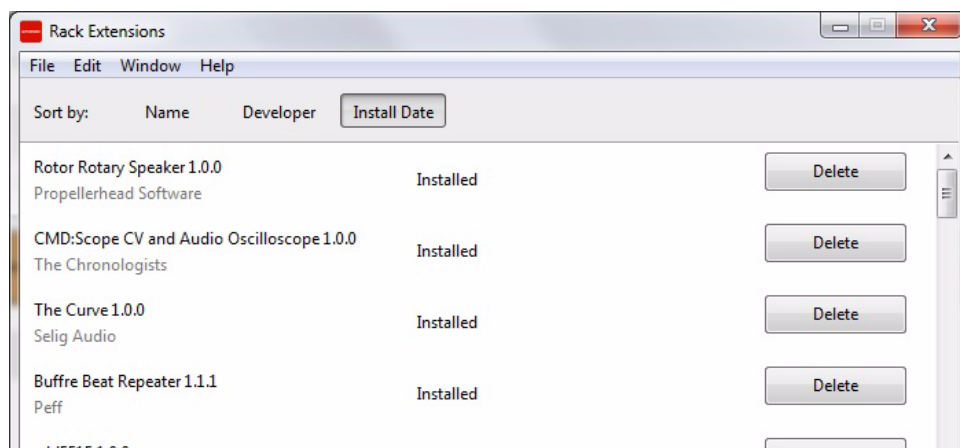

*The Authorizer application lists the Rack Extension devices currently installed on your computer.*

→ **You can choose to display your installed Rack Extensions either by Name, Developer or by Install Date, by clicking the desired "Sort by:" button.**

If you choose "Install Date", the latest installed Rack Extension is displayed at the top of the list.

**! Note: All of the listed Rack Extensions may not be available for use in Reason! For example, if you tried out a Rack Extension using a Trial license which has expired, the Rack Extension will still be installed and shown in the list. However, since you don't have a license for it, it won't be available for use in Reason.**

→ **Click the Delete button to uninstall the corresponding Rack Extension device.**

If you have purchased the Rack Extension, you can download it again at any time from your user account at the Propellerhead web site and reinstall it if you want.

# Using Rack Extensions in Reason

Rack Extensions behave just like internal Reason devices, and are listed together with the Reason devices in the Create menu subgroups and on the Device Palette in the Browser:

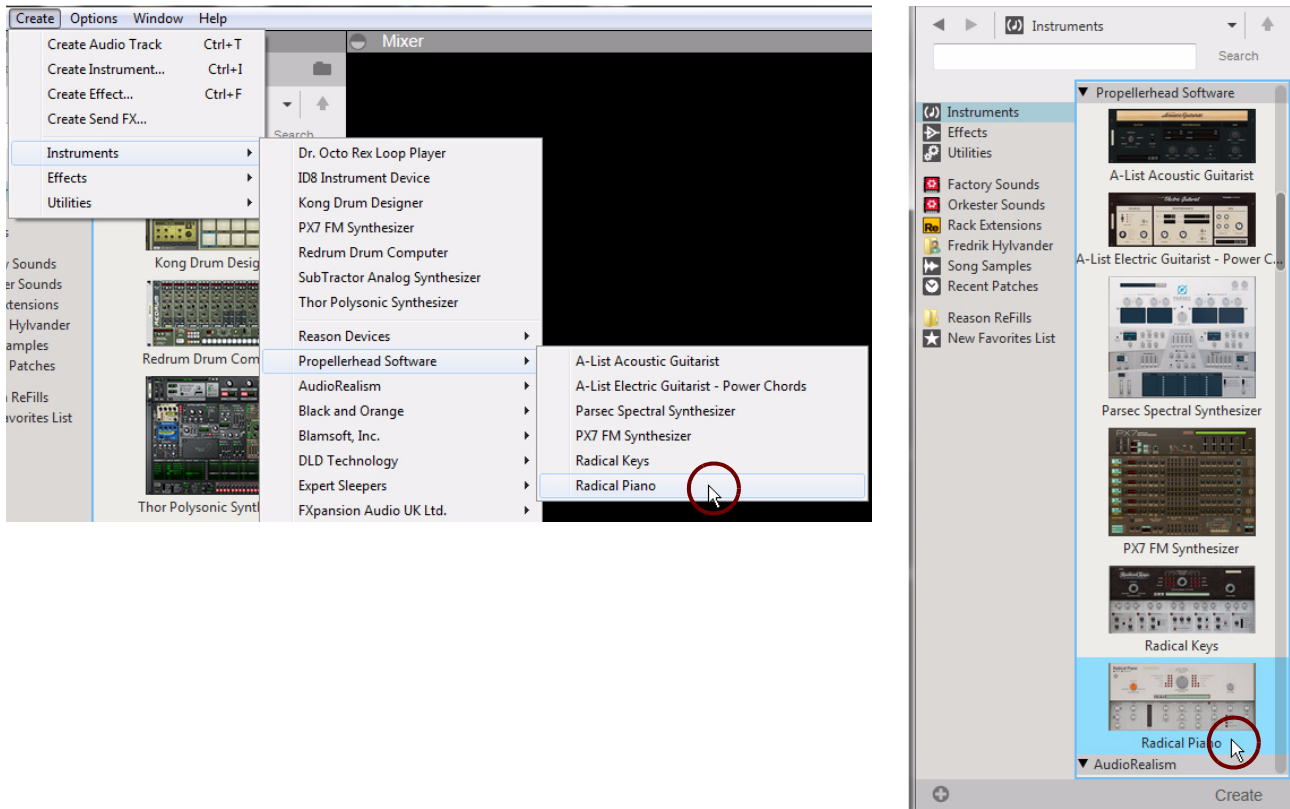

*The Radical Piano Rack Extension is available from the Create menu and on the Instruments device palette in the Browser.*

The installed Rack Extension devices are sorted in the appropriate subgroups and are listed, per manufacturer, in alphabetical order. However, Rack Extension devices from Propellerhead are always placed first in the list, below the internal Reason devices.

- **To create a Rack Extension device, either select it in the appropriate subgroup in the Create menu, double click or drag and drop from the Device Palette in the Browser, or select “Create Instrument...” or “Create Effect...” from the Create menu.**

The Rack Extension device is placed in the rack and routed according to the standard rules, see “[Creating devices](#)”.

If a Rack Extension supports patches, you will find the included patches in the Rack Extension itself. To get there:

**1. In the Browser, click "Rack Extensions" in the locations list to the left.**

This lists all available Rack Extensions in alphabetical order:

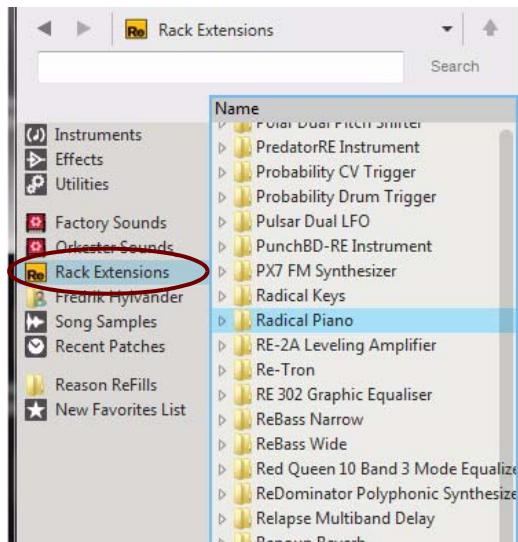

**2. Double click a Rack Extension folder (or click the expansion triangle) in the list to browse its patch content.**

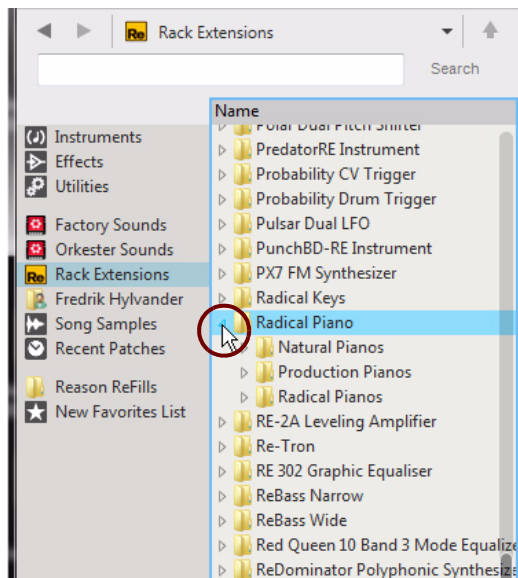

If you are browsing patches from a Rack Extension device (by clicking the "folder" button on the device panel), patches and folders for that specific device type are displayed in the Browser list right away.

## About missing Rack Extensions

When you open a Reason song from another user, it may have been created with Rack Extensions that you don't have. It might be a song from a friend, or a song that you have made using a Rack Extension with a trial license (that has since expired).

When you open such a song, the following alert appears:

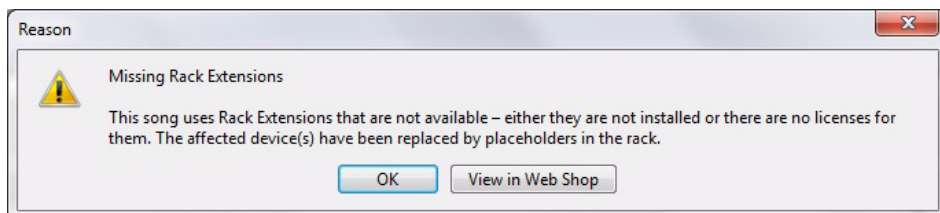

Now, you can choose to open the song without the Rack Extension(s), or go to the Propellerhead web shop and Try or Buy the missing Rack Extension(s). If you click OK, the song opens without the missing Rack Extension(s).

All such missing devices in a song are replaced by generic placeholder devices:



A "Missing Device" placeholder plate for a Rack Extension device, which is currently unavailable on your computer.

The placeholder device itself will be silent. If it's an effect, it will bypass the sound (or be silent, if connected as a send effect).

If you're collaborating with a friend you can safely save the song and send it back. When your friend opens the song, the Rack Extension device will be restored with all settings intact.

## Acquiring missing Rack Extensions

If you change your mind and want to hear the song with the Rack Extension(s) included, you could either download a paid version or a trial version from the Propellerhead web shop:

1. **Click inside the "View in web shop" area on the placeholder panel to get to the Propellerhead web shop and Try or Buy the Rack Extension:**



2. **After you have downloaded the (paid or trial) Rack Extension device(s), restart Reason and open the song again.**

Now, the Missing Device placeholders have been replaced by the downloaded Rack Extension(s) and the song will sound as originally intended.

# **Chapter 13**

## **Sounds, Patches and the Browser**

# About this chapter

This chapter deals with the following topics:

- **Handling Patches.**  
See “[About patches](#)”.
- **Using the Patch Browser.**  
See “[Using the Browser](#)”.
- **ReFills and Reason file formats.**  
See “[About ReFills](#)”.

## About patches

A patch contains settings for a specific device. Patches can be either separate files on your hard disk or files embedded in a ReFill (see “[About ReFills](#)” for info about ReFills). The devices that use patches are described below. The Mix Channel, Master Section and Audio Track devices can use Insert FX patches saved as Combinator devices. All other Reason devices use either Presets or can only be programmed using the device panel parameters.

## Reason devices that use patches

- **Subtractor, Thor and Malström synth patches contain all settings on the device panel.**  
Loading a patch brings up a new sound, just like when loading programs or patches on a hardware synthesizer.
- **Dr. Octo Rex patches contain information about what REX files are loaded in each slot, their settings as well as the parameter settings on the device panel.**  
It is important to note that the Dr. Octo Rex patch doesn't contain the actual REX files - only information about which REX files are used.
- **NN19 & NNXT sampler patches contain information regarding which samples are used, their settings (key mapping, tuning, etc.) and the parameter settings on the device panel.**  
It is important to note that the sampler patch doesn't contain the actual samples - only information about which sample files are used.
- **Redrum Drum Computer and Kong Kit Patches patches contain a complete “drum kit”, that is, information about which drum samples are used, together with the parameter settings for each drum sound.**  
Again, the actual samples are not included in the patch, only references to files. Also note that Redrum patches are separated from Redrum *patterns* - loading a new patch will not affect the patterns in the device.
- **Line 6 Guitar and Bass Amp patches contain information about the parameter settings on the device panel, as well as information about used Amp and Cabinet models.**  
Loading a patch brings up a new sound, just like when selecting programs or patches on a hardware effect device.
- **RV7000, Pulveriser, The Echo, Alligator and Scream 4 effect patches contain all settings on their respective device panels.**  
Loading a patch brings up a new sound, just like when selecting programs or patches on a hardware effect device.
- **The Combinator (Combi) patch format saves all settings and file references for each device in the Combi, along with the Combinator's own settings; key/velocity zones, modulation routing etc.**  
Any audio or CV routing from/to devices that are part of the Combi is also saved.
- ! **Note that patches for devices included in a Combi are not saved individually - e.g. if a Combi includes a Subtractor, and you have tweaked its settings, these settings will be saved with the Combi, but will not be saved as a separate Subtractor patch unless you do so from within the Combi - see “[Saving patches](#)”.**
- ! **Patches other than Combi patches do not include any cable routing information.**



## About the “Load Default Sound in New Devices” preference

On the “General” page in Preferences, there is an option (on by default) to load a default patch when creating a device. For some devices, there are a number of patches that exist outside category folders in the main Sound Bank folder for the device. These will be available on the browse list (see “About browse lists”) directly after creating the device, which allows you check out a few sounds for a device without opening the browser.

## Loading patches

Immediately after you have created a new device, the device automatically gets “browse focus”. This means that the Browser is temporarily “locked” to the device and displays patches for the device you just created. Browse focus for a device is indicated by orange side bars in the rack and on the sequencer track - and that the patch section on the device is colored in orange. In the Browser the orange Browse Focus field at the top now shows patches only for the highlighted device in the rack:



To load a patch for a device, use one of the following methods:

- ! For all the patch load methods described below, you can automatically revert back to the original patch, see “The Revert function”.
- Double click a patch in the Browser to automatically load it in the device that has browse focus.
- Use the up/down arrow keys, or click the Load Previous/Load Next triangle buttons at the bottom of the Browser, to select a patch in the Browser and automatically load it in the device that has browse focus.
- Click a patch in the Browser to select it, then click the Load button at the bottom of the Browser, or press [Enter] (not on the numeric key pad).
- Drag a patch from the Browser - or from the Windows Explorer (Win) or Finder (Mac) - and drop it on the device panel (or drop it on the device icon in the Sequencer Track List).
- ! Automatic browse focus can be turned off on the General page in Preferences, see “New devices get browse focus”.
- ! If you drop patches for other devices (of the same device type (Instruments or Effects)), the existing device will be replaced by the new device. You can also drag and drop patches onto devices that don’t support patches. In these situations, the new device replaces the current one and the dropped patch is automatically loaded in the new device.
- ! Note that Instrument devices can only be replaced by other Instrument devices. The same goes for Effect devices. Utility devices cannot be replaced using the “drag and drop” method!

- Click the **Select Patch** buttons on the device panel:

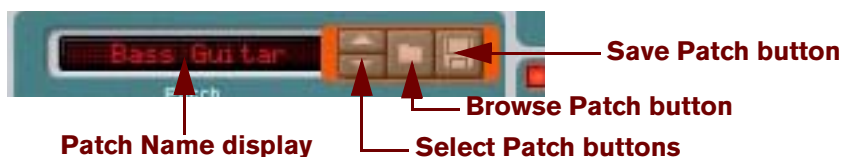

*The Patch section of the Subtractor device.*

- Click on the **Patch Name display** on the device panel to bring up a pop-up menu which lists all patches in the currently selected folder.
- Click the **Browse Patch button** on the device panel.  
This is useful mainly if a device doesn't already have browse focus. Clicking the Browse Patch button sets browse focus to the device. Then, you can select and load patches as described above.
- ! **On the panels of the Redrum, NN19, NN-XT, Kong and Dr. Octo Rex devices, there are also other Patch buttons, used for loading samples or REX files. Make sure you click on the button in the Patch section (next to the patch name display)!**

- **Select "Browse Patches..." from the Edit menu or device context menu.**  
This is useful mainly if a device doesn't already have browse focus. Selecting Browse Patches sets browse focus to the device. Then, you can select and load patches as described above.

Note that the Edit menu reflects which device is selected - in other words, you must select the device for the corresponding Browse Patches item to appear on the Edit menu.

- **Once you have loaded a patch, you can step between all the patches in the same folder by using the "Select Patch" buttons on the device panel:**



- **If you click on the Patch Name display on the device panel, a pop-up menu will appear, listing all patches in the currently selected folder.**

This allows you to quickly load another patch, without having to step through the patches one by one. You can also choose to set browse focus to the device by selecting "Open Browser..." from this pop-up menu.

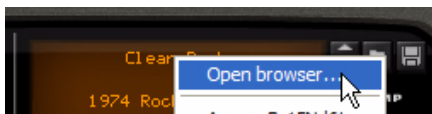

When you load a patch in any of the ways described above, the device's parameters will be set according to the values stored in the patch, and the name of the patch will be shown in the Patch Name display.

- ! **Any parameter adjustments you make on the device panel after loading a patch will not affect the actual patch file. For this to happen, you need to save the patch - see "Saving patches".**
- ! **You can also load patches from a MIDI Master Keyboard or Control Surface - see "Remote - Playing and Controlling Devices".**

## The Revert function

As soon as you have loaded a new patch into a device that has browse focus, the Revert button becomes available at the bottom of the browser list:

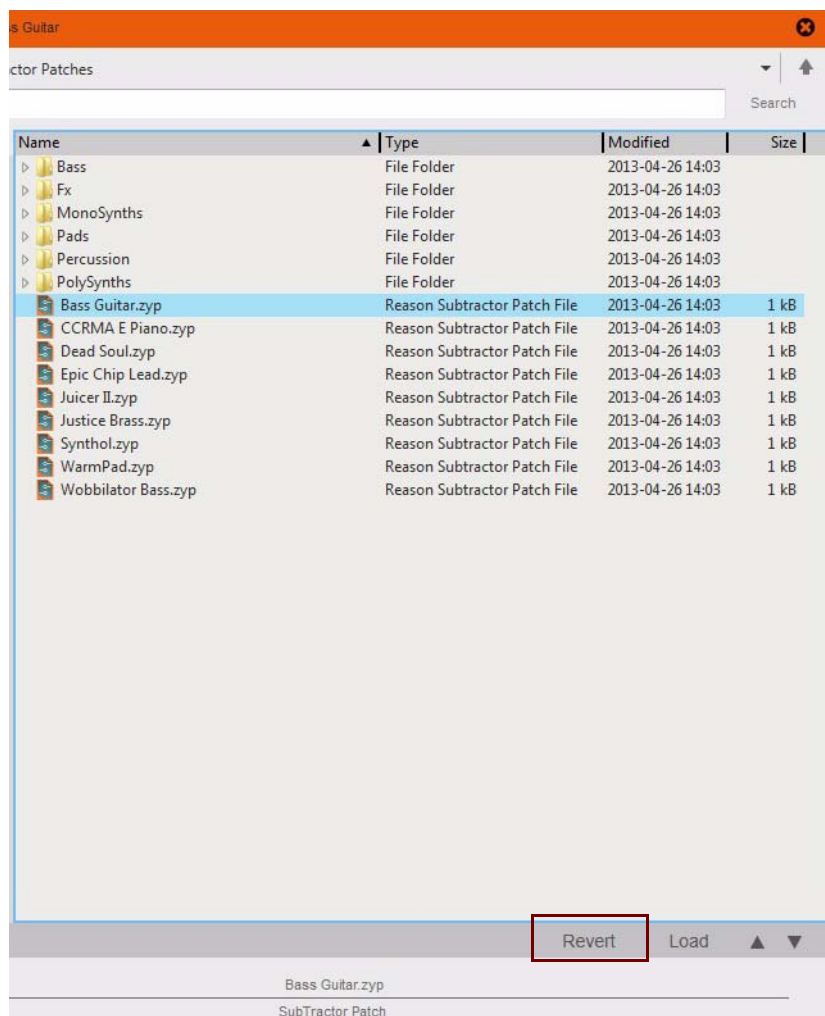

*The Revert button appears as soon as you load new patches into a device that has browse focus.*

The Revert function makes it possible to get back to the patch which was originally in the device - before you started loading new patches. This is very handy if you should change your mind and want your original patch back in your device. The Revert function also works if you have loaded patches for other device types, so called cross-browsing (see [“Cross-browsing patch files”](#)).

## If referenced samples are missing

As described above, patches for the Redrum, NN19, NN-XT, Kong and Dr. Octo Rex contain references to samples or REX files. Just like patches, samples can be independent files on the hard disk or elements within a ReFill. However, if sample files have been moved or renamed after a patch was saved, the sample file references in the patch will not be accurate.

If this is the case when you select a patch, the program will tell you so. You can then choose to either manually locate the missing files, to have the program search for them, or to proceed without the missing sounds. For details, see [“Handling Missing Sounds”](#).

**! Proceeding without locating or replacing the missing samples will result in silent drum channels, key zones or loop slots (for the Redrum, NN19/NN-XT, Kong and Dr. Octo Rex respectively).**

## Clearing browse focus

To clear browse focus for a device, use one of the following methods:

- Click anywhere in the rack background.
- Click the X symbol to the right on the orange browse focus label at the top in the Browser.
- Select another sequencer track (if the rack is not detached).

## Setting browse focus

Apart from when creating and loading patches into a device, browse focus can be set anytime you like. This is very useful if you're working in the sequencer where there are no browse buttons. Or if you want to set browse focus to a non-patch device and replace it with something else.

### 1. Select a device in the rack, or a track in the sequencer.

In this example we select a Redrum track in the sequencer. As soon as the track (or device) is selected, the Browser shows the track/device name on a gray background in the Browse Focus field:

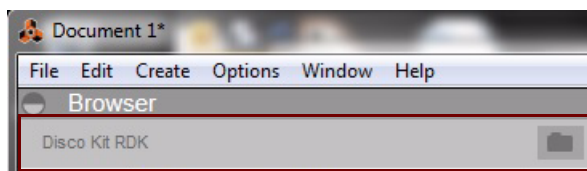

### 2. Now, click the folder button in the Browse Focus field:

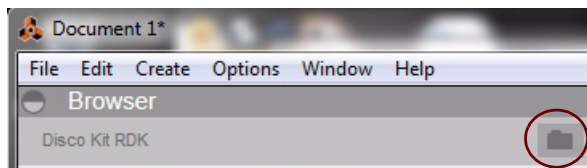

Browse focus is now set to the Redrum device:

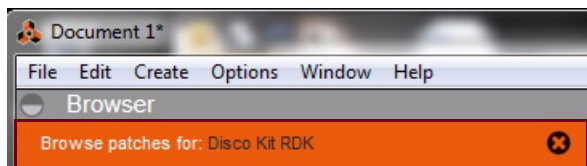

### 3. Now, you can browse and load new patches into the Redrum device.

### 4. When you are done, clear the browse focus by clicking the X button in the browse focus field.

! If you are using two Browsers, the one in the Song window and the other in the detached rack window, browse focus can only be set in one of the Browsers at a time.

# Saving patches

## Saving device settings in a song

When you save a Reason song, all settings for all devices are automatically included in the song file - there is no need to save the patches separately.

- ! **It's important to realize that it's the actual settings that are saved in the Song - not references to patches on disk. The next time you open the song, all devices will be set as they were when you saved it (regardless of whether you have removed or edited any patches on disk).**
- ! **Note that device samples are not stored with the Song by default. This means that if you edit any Redrum, Kong or NN19/NN-XT samples in an external application and then open a Song containing devices that use these samples, the sound will be different. It's possible, however, to store actual device samples together with the Song using the "Self-Contain" feature. See ["About Self-Contained Songs"](#).**

## Saving device settings as patches on disk

Even though the device settings are stored with the song, you may want to save any settings you have made for a device as a separate patch file. This allows you to use the patch in other songs, and lets you try out other patches in your song without the risk of losing your original sound. A patch is saved as follows:

1. **Click the "Save Patch" button on the device panel:**



2. **In the file dialog that appears, specify a location and name for the patch file and click Save.**

- **Under Windows, the different types of patch files have different file extensions.**  
File extensions are automatically added by Reason when you save. Under Mac OS X, file extensions are not needed but it may be a good idea to keep them if you want the saved files to be usable under Windows.
- **If you have selected a patch, modified it and want to save it with the modifications, you could either save a separate, modified version of the patch (with a new name) or simply overwrite the old patch file on disk.**  
As usual, you will be asked whether you really want to replace the existing patch file.
- ! **Note that you can save a patch under the same name and location without having the save dialog appear by holding down [Alt](Win) or [Option](Mac) and clicking the "Save Patch" button on the device panel. Be aware that this overwrites the original patch!**
- ! **Note also that you cannot save into a ReFill! This means that if you have opened a patch from within a ReFill, modified it and want to save it, you need to save it as a separate file in a new location (outside the ReFill). Preferably, you should also rename the modified patch file, to avoid confusion.**

## Copying and pasting patches between devices

A quick way to copy device parameter settings between devices of the same type is to use the “Copy Patch” and “Paste Patch” functions. The result is exactly the same as if you had saved a patch from one device and opened it on another device of the same type - this is just a quicker method.

**! Copying and Pasting settings is possible with all device types that can use patches.**

Proceed as follows:

- 1. Select a patch, and/or make the desired settings on the source device.**  
Make sure the device remains selected.
  - 2. Select “Copy Patch” from the Edit menu or from the device context menu.**
  - 3. Select the destination device of the same type (in the same song or another song).**
  - 4. Select “Paste Patch” from the Edit menu or from the device context menu.**  
The settings of the source device (including Redrum, NN19, NN-XT and Kong sample references and Dr. Octo Rex REX loop references) are applied to the destination device.
- ! Note that this operation simply copies the settings from one device to another. Adjusting the settings on one of the devices will not affect the other; neither will the settings affect any patch file on disk.**

## Copying Main Mixer Insert FX settings and paste as Combinator patches

You can copy Insert FX settings from Main Mixer channels and paste these as Combinator effect patches - or vice versa. To copy a Main Mixer channel Insert FX setting and paste into a Combinator device, follow the steps below:

- 1. Select the desired Mix Channel/Audio Track device in the rack, or the desired Mixer Channel in the Main Mixer.**
- 2. Select “Copy Channel Settings -> Insert FX” from the Edit menu or device/Mix Channel context menu.**  
The Insert FX devices with their settings and connections are placed on the computer’s clipboard memory.
- 3. Select the desired empty Combinator device in the rack - or create a new Combinator device and select it.**
- 4. Select “Paste Patch” from the Edit menu or the device context menu.**  
The Insert FX devices with their settings and connections are pasted into the Combinator device.

To copy an effect patch in a Combinator device and paste it as an Insert FX in a channel strip in the Main Mixer, proceed as follows:

- 1. Select the Combinator device which contains the effects you want to copy.**
- 2. Select “Copy Patch” from the Edit menu or the device context menu.**  
The Combinator effect devices with their settings and connections are placed in the computer’s clipboard memory.
- 3. Select the desired Mix Channel/Audio Track device in the rack, or the desired channel strip in the Main Mixer.**
- 4. Select “Paste Channel Settings: Insert FX” from the Edit menu or the device context menu.**  
The Combinator devices with their settings and connections are pasted into the Insert FX section of the selected Mix Channel/Audio Track device.

## Initializing patches and resetting device parameters

Sometimes it is useful to start with a “clean slate” when creating a synth sound, a drum kit or a sampler patch. This is achieved by selecting “Reset Device” from the Edit menu or from the device context menu. This resets all parameters to “default” values. Initializing NN19, NN-XT, Dr. Octo Rex, Kong or Redrum devices will also remove all sample/REX file references, allowing you to start from scratch.

# About ReFills

A ReFill is a kind of component package for Reason which can contain sounds and effects patches, samples, REX files, SoundFonts and demo songs. If you like, you can compare ReFills to ROM cards for a hardware synthesizer. On your computer, ReFills appear as large files with the extension “.rfl”.

All sounds included with Reason are embedded in a ReFill named “Factory Sound Bank” which was copied to the hard disk during installation.

Additional Propellerhead ReFills are available for purchase. You can also download ReFills from other Reason users on the Internet, purchase them from other sample manufacturers, etc.

- **Samples (Wave and AIFF files) are compressed to about half their original file size when stored in ReFills, without loss of quality.**

In Reason, you can use the browser to list and access the embedded sounds and other components within the ReFills, just as if the ReFills were folders on your hard disk.

Furthermore, if a song makes use of components from ReFills, Reason will tell you which ReFills are required.

# Using the Browser

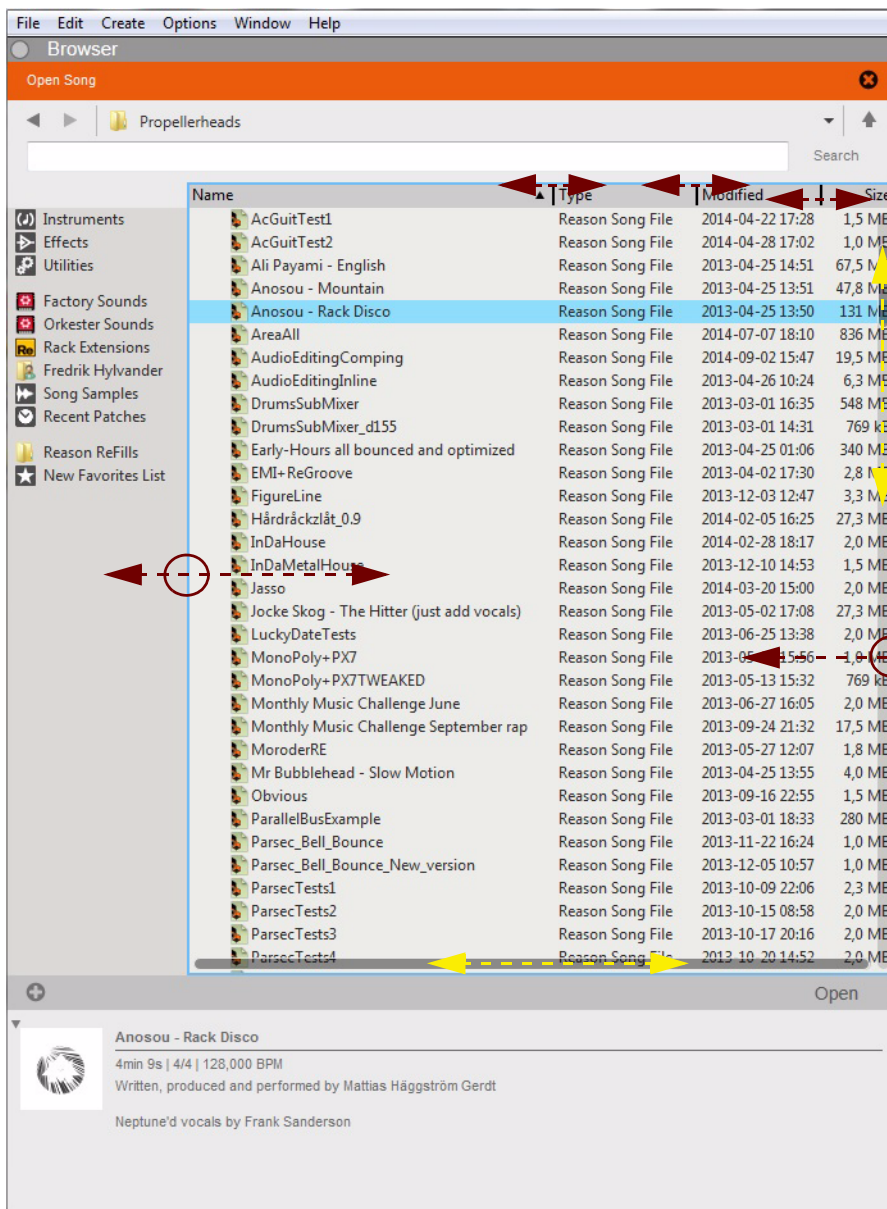

The Browser when using the File/Open... command.

The Browser is used when you open songs or load patches, samples, audio files, MIDI files and REX files, from regular file folders or from a ReFill.

→ **Open and close the Browser by pressing [F3] or by selecting Show/Hide Browser from the Windows menu.**

! **If you have the rack detached in a separate window, you can have a second Browser in the rack window, see “About using the Browser in the detached rack”.**

The Browser can also be resized by dragging the edges of the browser list sideways, as shown in the picture above. Each column in the browse list can also be resized. You can also scroll horizontally and vertically (when applicable) using the scrollbars to the right and at the bottom of the browse list (yellow arrows in the picture above).



Besides standard file folder browsing, the Browser offers several useful functions:

- **Search for files by name and/or type - see “Using the “Search” function”.**
- **Use “cross-browsing” to search for patches belonging to any type of device.**  
For example, set browse focus from a Subtractor device by clicking its Browse Patch button. Instead of limiting the Browser to show only Subtractor patches, you can choose to browse for any type of instrument patch. If you select a patch with a different format than the device you are browsing from, the original device will be replaced by the new device. See “Cross-browsing patch files”.
- **Create Favorite Lists containing shortcuts to your favorite files for instant access.**  
See “Favorites Lists”.
- **Audition audio samples and loops on the fly.**
- **Save shortcuts to various locations on your local drive(s).**  
See “Using Locations and Favorites”.

## Opening the browser

Besides pressing [F3] you can use any of the following commands to open the Browser (what file types you can browse for depends on which method you used to open the Browser):

- **By selecting “Open” from the File menu.**  
This opens the Browser where you can select to open a Song (.reason, .rsndemo, .ree, .reedemo, .rltd, .record, .recdemo, .rns, .rps and .rsb).
- ! **If no Song document is open on the Mac OS X version of Reason, Reason temporarily opens an empty Song document to be able to show the Browser. When a Song has been loaded, the empty document closes.**
- **By selecting “Browse Patches” on the Edit menu with a patch based device selected (or by clicking the “Browse Patches” button on the device panel).**  
This opens the Browser allowing you to browse for and load patches for the selected device, or use “cross-browsing” (see “Cross-browsing patch files”) to select patches for other device types.
- **By selecting “Browse Insert FX Patches” on the Edit menu with a Main Mixer Channel or Mix Channel/Audio Track device selected.**  
This opens the Browser, where you can browse for and load Combinator Effect patches.
- **By selecting “Browse Samples” on the Edit menu with a sample based device selected (or by clicking the “Browse Samples” button on the device panel).**  
This opens the Browser, where you can browse for, preview and load samples in the supported audio formats.
- **By selecting “Browse ReCycle/REX Files” on the Edit menu with a Dr. Octo Rex Loop Player selected (or by clicking the “Browse Loops” button on the device panel).**  
This opens the Browser, allowing you to browse for, preview and load REX loops into the Dr. Octo Rex device.
- **By selecting “Browse Drum Patches” on the Edit menu with a Kong Drum Designer device selected (or by clicking the “Browse Drum Patch” button on the Drum Control Panel on the device).**  
This opens the Browser, allowing you to browse for Kong Drum Patches and supported audio files to load into a slot in the Kong Drum Designer device.
- **By selecting “Import Audio File” from the File menu.**  
This opens the Browser, allowing you to browse for, preview and load files in the supported audio formats to an audio track in the sequencer. See “Importing audio to the sequencer”.
- **By selecting “Import MIDI File” from the File menu.**  
This opens the Browser, allowing you to browse for MIDI files to import to instrument tracks in the sequencer. See “Importing Standard MIDI Files”.
- **By selecting “Create Instrument...” or “Create Effect...” from the Create menu.**  
This allows you to browse for and load patches for any device. See “Create Instrument/Create Effect”.

# Browser elements

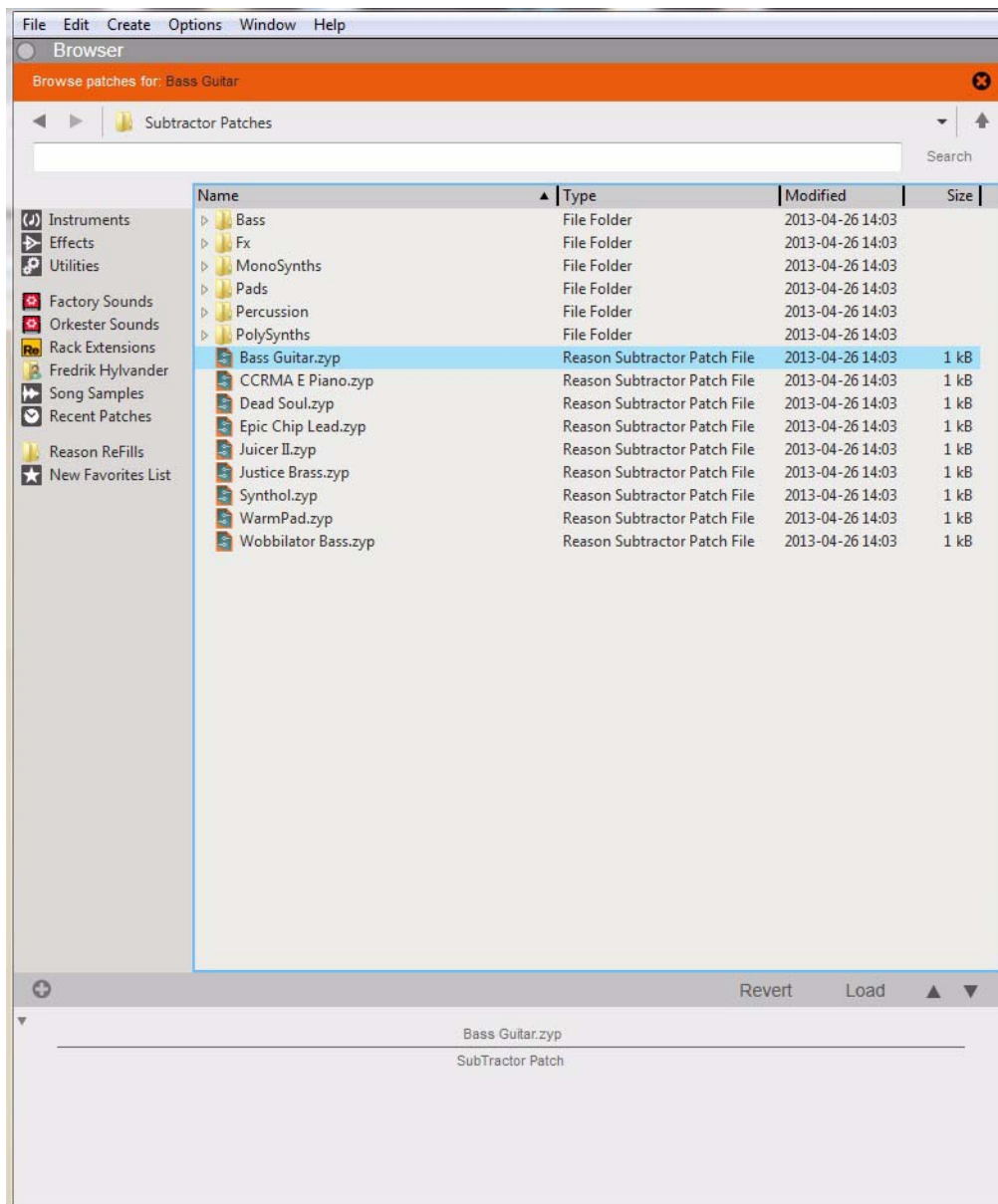

*The Browser when using the Browse Patch button/function on a Subtractor device.*

Regardless of what command you used for opening the Browser (Open/Browse Patch/Import Audio etc.), the Browser basically contains the same main elements:

## Browse focus field

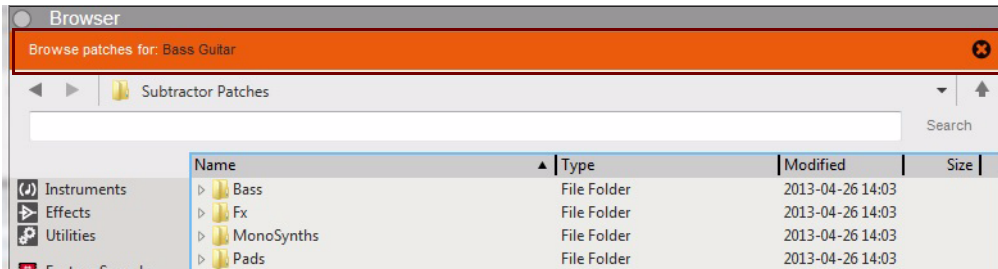

This field shows the name of the currently selected device in the rack - or the currently selected sequencer track. The Browse Focus field is orange when a device or track has browse focus - and gray when no focus is set. See [“Setting browse focus”](#) and [“Clearing browse focus”](#) for more information.

## Root Folder drop-down list

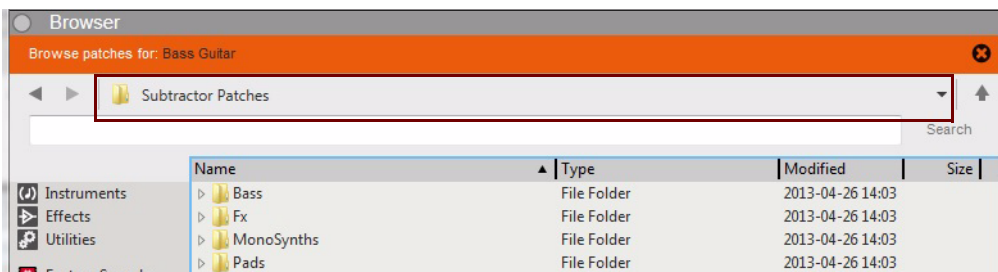

This field displays the name of the currently selected root folder.

- **Click in the name field to bring up a drop-down list where you can move up in the folder hierarchy.** Search results and Favorites lists, however, are shown as “flat” lists - with no folder hierarchy.
- **Click on the (arrow) button to the right of the root folder list to move up in the hierarchy one level at a time:**

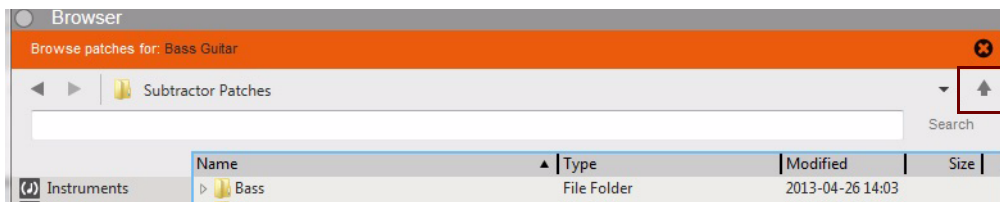

## Back/Forward buttons

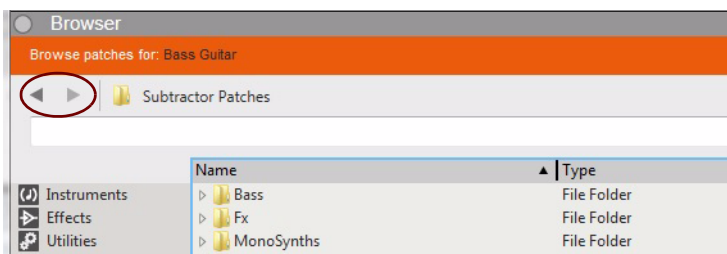

These arrow buttons allow you to move between the browser locations opened while browsing, much like pages in a web browser.

## Locations and Favorites list

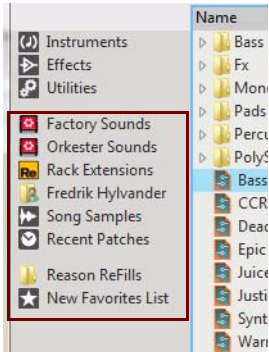

This list contains shortcuts to various locations. You can manually add any locations (on any local drive) to the bottom section of the list. The locations in the upper part of the list are default and cannot be changed. Selecting an item in the “Locations and Favorites” list will open the corresponding folder/ReFill as the root in the main files and folder list - see [“Navigating in the Browser”](#).

In the “Locations and Favorites” list you could also create your own “Favorites Lists”. The “Favorite Lists” can contain shortcuts to your favorite patches, samples or song files - see [“Favorites Lists”](#).

## Search text field

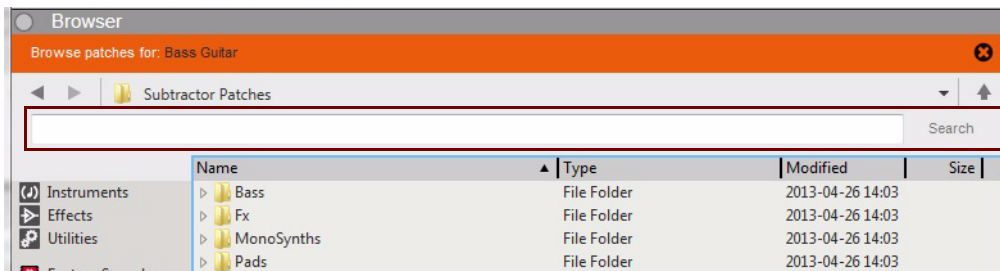

Here you can enter a text string and click Search to search for Song files, patches, audio files and samples. The Search function is described in [“Using the “Search” function”](#).

## Browser list

Name	Type	Modified	Size
▶ Bass	File Folder	2013-04-26 14:03	
▶ Fx	File Folder	2013-04-26 14:03	
▶ MonoSynths	File Folder	2013-04-26 14:03	
▶ Pads	File Folder	2013-04-26 14:03	
▶ Percussion	File Folder	2013-04-26 14:03	
▶ PolySynths	File Folder	2013-04-26 14:03	
▶ Bass Guitar.zyp	Reason Subtractor Patch File	2013-04-26 14:03	1 kB
▶ CCRMA E Piano.zyp	Reason Subtractor Patch File	2013-04-26 14:03	1 kB
▶ Dead Soul.zyp	Reason Subtractor Patch File	2013-04-26 14:03	1 kB
▶ Epic Chip Lead.zyp	Reason Subtractor Patch File	2013-04-26 14:03	1 kB
▶ Juicer II.zyp	Reason Subtractor Patch File	2013-04-26 14:03	1 kB
▶ Justice Brass.zyp	Reason Subtractor Patch File	2013-04-26 14:03	1 kB
▶ Synthol.zyp	Reason Subtractor Patch File	2013-04-26 14:03	1 kB
▶ WarmPad.zyp	Reason Subtractor Patch File	2013-04-26 14:03	1 kB
▶ Wobbilator Bass.zyp	Reason Subtractor Patch File	2013-04-26 14:03	1 kB

This is the Browser list, showing the contents of a selected folder - see ["Navigating in the Browser"](#).

## Patch Load section

At the bottom of the Browser list are a buttons for selecting and loading patches:

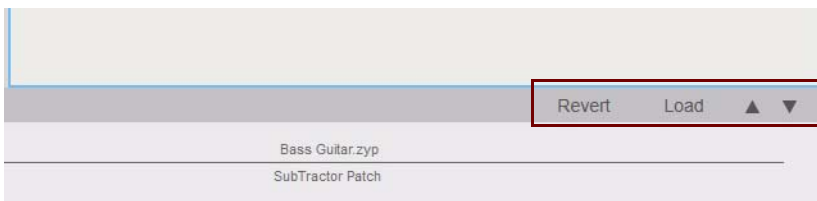

- **Click a patch in the Browser list and then click the Load button to load the patch in the device.**
- **Click the triangular Load Previous/Load Next buttons to automatically load the previous/next patch in the device.**  
Alternatively, press the up/down arrow keys on the computer keyboard.
- **Click the Revert button to revert to the patch that was originally in the device, before you loaded new patches.**  
See ["The Revert function"](#) for more details.

## Info and Details



*The info pertaining to a selected Song file.*

The “Info” section at the bottom of the Browser can show Song/ReFill splash images and also information about the item currently selected in the “Files and Folders” list. Exactly what information is shown here depends on the selected file type. For example, samples or REX files contain information about the file format and length of the selected file, while a selected song file can display comments from the author (see [“Including Song Information”](#)) etc. If the selected file is part of a ReFill, this will be indicated regardless of the file type.

- **Click the triangular fold/unfold button at the top left to show/hide the Info and Details section.**  
Folding the Info and Details section automatically expands the Browse list/device palette downwards.

## Audition section (for audio files, samples and REX files)



This section contains controls for auditioning audio files, samples and REX files - see [“Selecting and auditioning samples and REX loops”](#). For other file types, the “Audition” section is not present.

## Navigating in the Browser

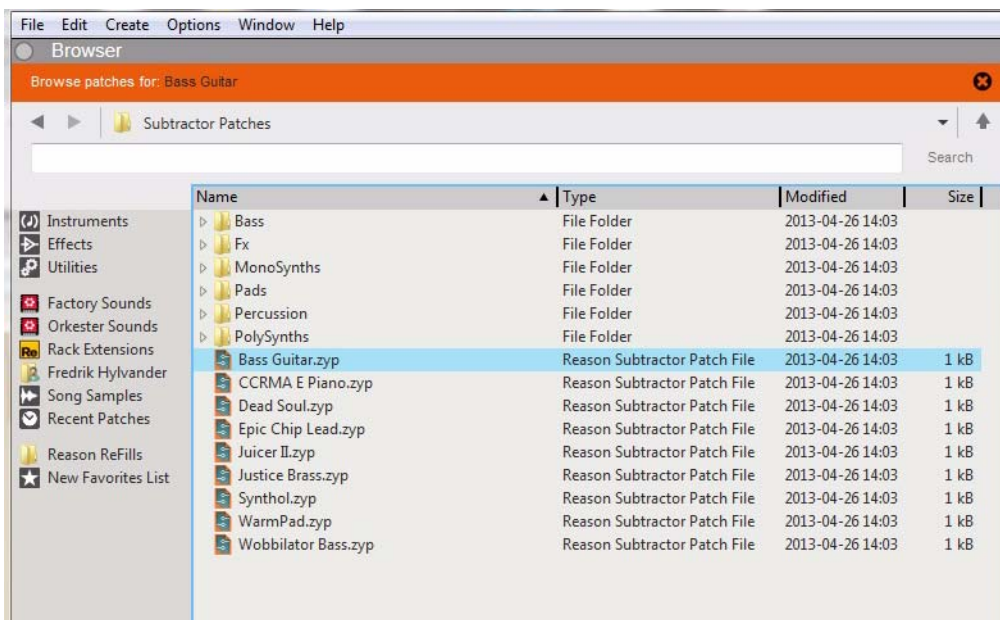

*The Browser with browse focus set to a Subtractor device, allowing you to browse for and load Subtractor patches.*

When navigating in the Browser, items are shown as a hierarchical list in a selected root folder, just like in your computer’s file browser (Finder on Mac and Explorer on Windows).

All folders and sub-folders within a root folder are shown, but only files of the relevant type (i.e. songs/samples/patches etc.) can be viewed/selected in the Browser. For example, if you have selected to browse samples for a NN-XT device, only audio samples and REX files will be shown in the Browser.

- Click on the triangular symbol next to a closed folder to expand it. If the folder contains files of the relevant type, these will be shown.
- Double-clicking a folder in the list opens it as the root folder in the Browser.
- The “Name”, “Type”, “Modified” and “Size” columns show the name of the folder or file, the file/folder type, the modification date and the size (files only), respectively.
- Clicking on a column header sorts the files accordingly (i.e. alphabetically, by file type, by modification date or by file size).  
Click the same column again to toggle between ascending or descending display order.
- You can use the “Back/Forward” buttons to move between the different locations you have opened in the Browser.  
When you hide the Browser the “location list” is cleared.
- Use the up/down arrow buttons on the computer keyboard to step between files in the current Browser list and automatically load them into the device.  
Only files will be stepped through, while folders are skipped.
- The Root Folder drop-down list to the right of the “Back/Forward” buttons allows you to move up in the folder hierarchy when the Browser points to a specific folder location (see “About hierarchic and flat lists” below).
- If you want to browse for patches for other devices, click the X button on the orange field to clear the Browse focus from the existing device type.  
If you select and load a patch for another device type, the new device will replace the device that previously had Browse focus.

## About hierarchic and flat lists

In certain circumstances the Browser will display a flat list without any folder hierarchy. In such cases there will be an extra “Parent” column displaying the parent folder location for all files. The “Root Folder” drop-down list will then also contain a shortcut to the selected file’s parent folder - the “Go To Parent Folder” item.

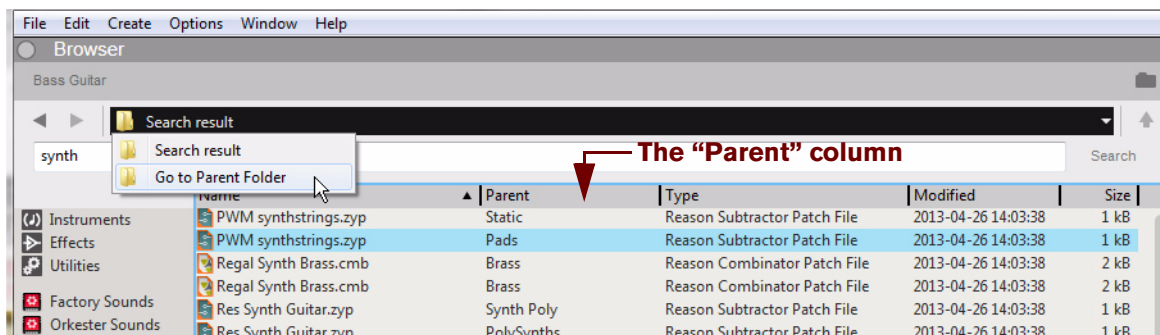

*The Browser display for flat lists.*

Flat lists are shown in the following cases:

- When the Browser is showing a search result - see “Using the “Search” function”.
- When the Browser is showing a Favorites folder list - see “Favorites Lists”.
- When the Browser is showing a browse list stored for a device in a saved song - see “About browse lists”.

## Using Locations and Favorites

To help you to find your files quickly, you can add shortcuts to the folders where you store your samples and patch files etc. By default, the Locations list contains five fixed locations; the Reason Factory Sound Bank, the Reason Orkester Sound Bank, the Rack Extensions location, the (your) User folder, the Song Samples location and the Recent Patches location. You can easily add your own locations below this list if you like.

- **Selecting a Location or Favorite List in the list opens it as the root folder in the Browser.**
- **To add a new Location, select a file, folder or ReFill in the main browser list and drag and drop it in the “Locations and Favorites” list.**

Any new Locations will be added below the list of fixed locations. An insertion line is shown to indicate where in the list the new location will be placed. Manually added locations can later be reordered by dragging and dropping.

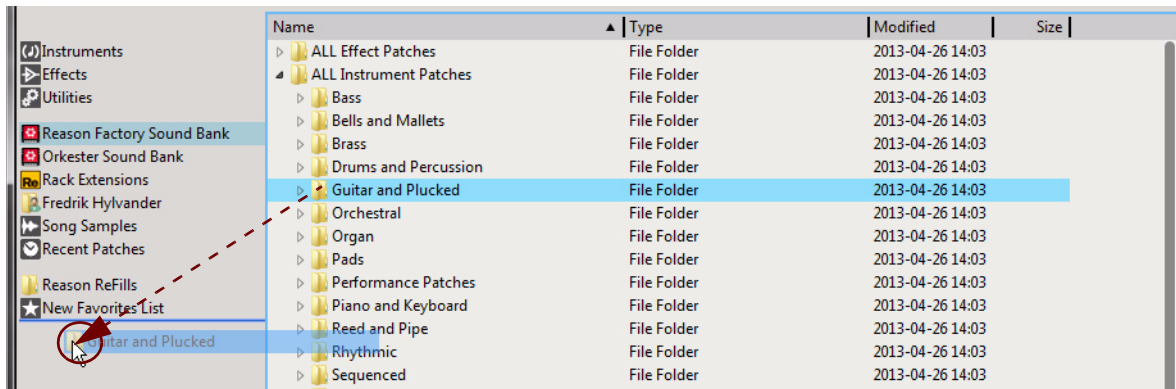

*Adding a new Location.*

- ! **Even though it is possible to add individual ReFills as separate Locations, we strongly recommend that you create a ReFill folder in which you put all your ReFills; then add the ReFill folder as a Location:**



The reason for this is that some ReFills (such as the Reason Electric Bass) consist of several ReFill files: one which contains patches and another that contains the samples. If you should add only the patch ReFill as a Location and not the samples ReFill, Reason won't find the samples that correspond to the patches.

- **If you don't want to put all your ReFills in one folder, you can create shortcuts (alias) to the ReFills and put all the shortcuts in a single folder which you then add as a Location.**
- **To remove a Location (or Favorite List), select it in the “Locations and Favorites” list and press [Backspace] or [Delete] - or click the “Remove Favorite” button.**  
Alternatively, select “Delete” from the context menu.

! **The default locations cannot be removed.**

• **Manually added locations are stored in the Preferences file in the Reason application folder.**

! **If a stored location has been removed or is unavailable, a warning triangle with an exclamation mark is shown before the location name in the “Locations and Favorites” list.**

## Favorites Lists

“Favorites Lists” provide a way to group and order files that may be physically located at different places on your local drives. Any file that can be loaded in Reason (songs, patches, samples etc.) can be added to a “Favorites List”. Only shortcuts to the files are added - the original files aren't moved.



This is particularly useful for handling patches. By adding the patches you need for a given situation to a Favorite List, you can determine exactly which patches will be selectable for a device, and in what order. You can then sequentially step through these patches using patch select buttons on your MIDI keyboard or control surface device. See [“Using Favorites - a practical example”](#).

! **We strongly recommend not to put ReFills in Favorite Lists. Instead, use Locations for ReFills, see [“Using Locations and Favorites”](#).**

→ **To add a New Favorite List, click the “Create New Favorite Lists” button.**

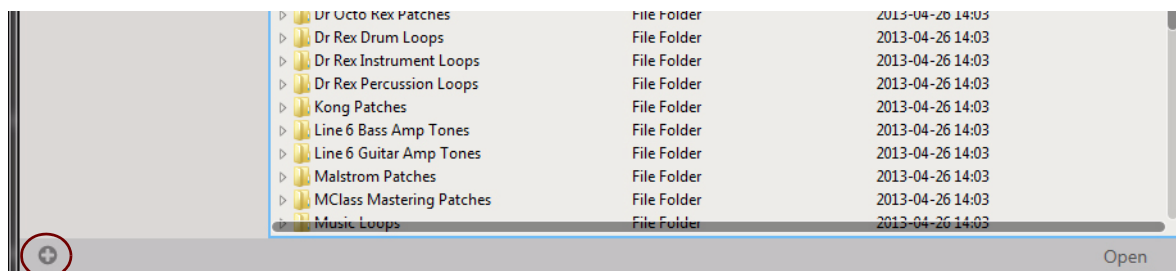

The “Create New Favorites Lists” button

An empty “folder” is created, named “New Favorite List n”. Favorite Lists are always indicated by a star icon. The Browser list remains unchanged.

→ **To rename the “New Favorite List” folder, double-click it and type in a new name.**

Alternatively, select “Rename” from the context menu.

→ **To add a file to the “Favorite List” folder, select it in the Browser and drag it to the desired “Favorite List” folder.**

You can also select multiple files using standard selection techniques - [Shift] and/or [Ctrl](Win) or [Command] (Mac) - and drag these into the folder in the same way.

→ **Select the “Favorite List” folder to view the currently added files in the Browser list.**

The Browser displays all files you have previously dragged to the Favorite List, regardless of file type:

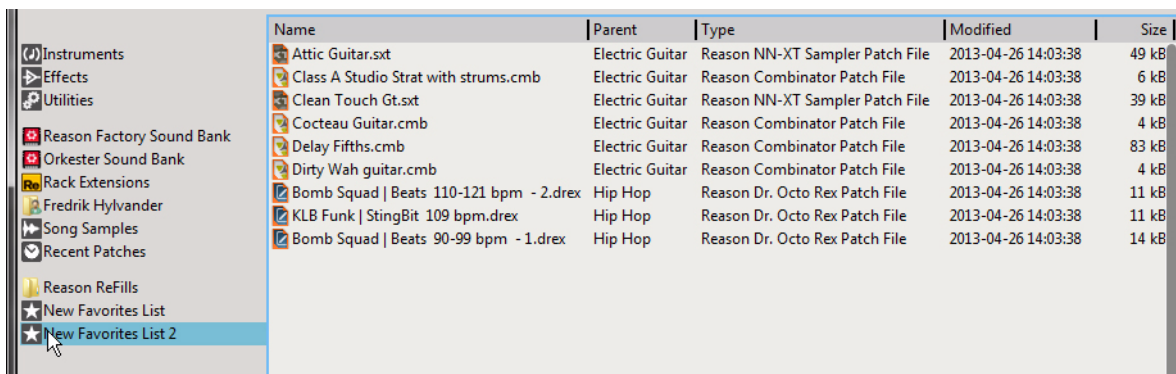

• **When a “Favorites List” folder is selected in the Browser, an additional “Parent column” is shown (just like for Search results), listing the name of the original folder for each file in the list.**

• **Files in a “Favorites List” folder cannot be sorted by clicking the column headers. However, they can be reordered by using drag and drop in the Browser list.**

→ **To remove files from a “Favorites List” folder, select the folder and then select the files in the Browser list and press [Delete], or select “Delete Favorite(s)...” from the context menu.**

This removes the shortcut only - the original file isn’t affected.

→ **To remove a “Favorites List” folder, select it and press [Backspace] or [Delete] - or select “Delete Favorites List...” from the context menu.**

## Using Favorites - a practical example

Here follows a practical example of how you can use Favorites for patch files:

You are preparing for a live gig as a keyboard player. You know the songs, and you have chosen suitable patches (in various device formats) for each song.

You want to use Reason, but you want to be able to switch to the correct patch for each song using your MIDI keyboard, and not have to worry about fiddling with the computer during your performance.

Here is how this can be done by using Favorites:

### 1. Create a new Reason song.

### 2. Create a device, for example a Combinator.

It doesn't matter which instrument device you choose at this point.

### 3. Click the “Create New Favorites Lists” button.

A new folder appears in the list. Double-click it and type in an appropriate name (e.g. “The Band”).

### 4. Click the Reason Factory Sound Bank and then expand the “All Instrument Patches” folder in the Browser list.

Now you can start locating the instrument patches you need by navigating in the Browser.

### 5. When you have located a patch that you need for the gig, drag it from the Browser list into the Favorites List folder.

If this was a patch in a different format than the instrument you created, a device of this type will replace the original device (see “[Cross-browsing patch files](#)”).

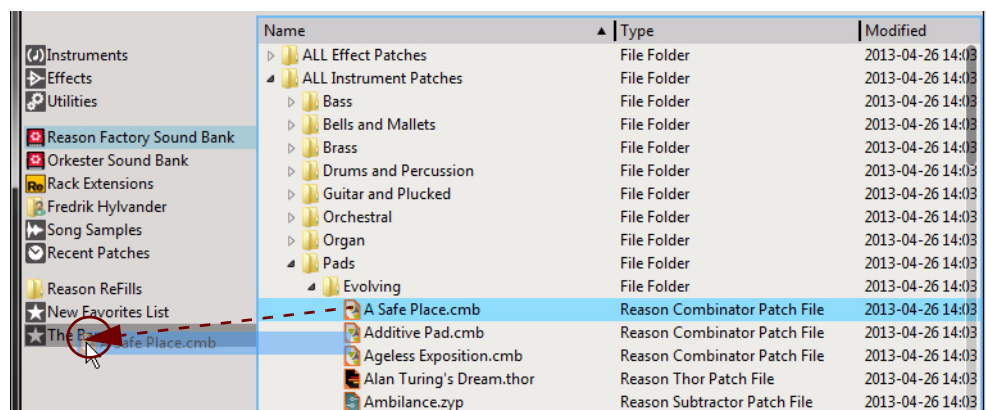

### 6. Continue to add new instrument patches in the same way until you have all the patches you need.

### 7. When you're done, select the (The Band) Favorites List folder.

All the patches you added are now listed in the Browser list.

### 8. Use drag and drop to order the patch files in the Browser list according to the set list.

### 9. Double click the first patch file in the (The Band) Favorites List.

The patch is loaded in the appropriate device.

### → If you have a MIDI keyboard or control surface with programmable buttons, you can assign a button to “Select next patch” on the device.

Many MIDI keyboards and control surfaces have buttons assigned to patch selection - check the Control Surface Details document for information about your controllers. Alternatively, you can manually assign buttons for selecting patches - see the “[Remote - Playing and Controlling Devices](#)” chapter.

### 10. Save the Song.

### 11. At the gig, open the song, and the first patch will be loaded.

### 12. When the first song is finished, use the “next patch” button on the device or on your MIDI keyboard and the next patch in the (The Band) Favorites List will be loaded!

## Selecting and auditioning samples and REX loops

For audio files, samples and REX loops you can use the Audition controls in the Browser to preview the audio. This is done in the following way:

- **Select the audio or REX file in the Browser list and click the triangular Play button.**

The file is played back. During playback, the Play button in the Audition section switches to a square “Stop” button - click this to stop playback.

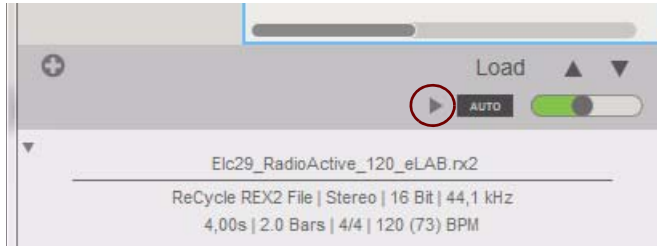

- **Alternatively, you can click the Auto button to automatically audition the file as soon as you select it in the Browser list.**

The selected file is automatically played back. Again, click the Stop button to stop playback.

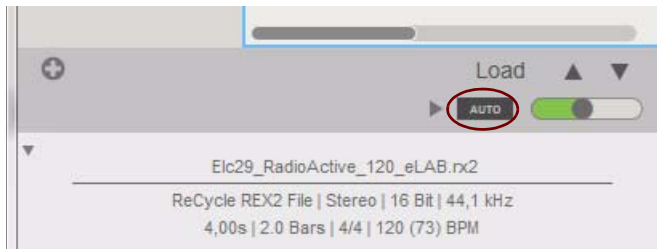

- **Adjust the playback level with the slider to the right of the Auto button.**

## Selecting multiple files

It is possible to select multiple files in the Browser, by using standard [Shift] or [Ctrl](Win) or [Cmd](Mac) selection techniques. This, however, doesn't necessarily mean that the selected files can be loaded. There are a number of instances where selecting several files in the Browser file list is relevant:

- **It is possible to load several drum patches (on consecutive pads) simultaneously into the Kong device.**  
See the “[Kong Drum Designer](#)” chapter for details.
- **It is possible to load several samples simultaneously into the NN-XT, NN19 and Kong NN-Nano sampler devices.**  
See “[NN-19 Sampler](#)”, “[NN-XT Sampler](#)” and “[NN-Nano Sampler](#)” for details.
- **It is possible to load several REX files simultaneously into the Dr. Octo Rex device.**  
See the “[Dr. Octo Rex Loop Player](#)” chapter for details.
- **It is possible to simultaneously import multiple audio files to the sequencer.**  
See “[Importing audio to the sequencer](#)” for more info.
- **You can select several files to add them to a Favorites List in one go - see “[Favorites Lists](#)”. Note that this is only possible if a device does not have browse focus!**
- ! **In situations where several selected files (e.g. patches or songs) cannot be loaded, the Create/Load button in the Browser is grayed out.**

# Cross-browsing patch files

Cross-browsing patches is a powerful feature of the Browser. It allows you to browse for any type of instrument patches or effect patches, regardless of which instrument or effect device you opened the Browser from.

## About instrument and effect patches

Patches are internally divided into two patch categories in the Browser; instrument patches and effect patches (the Browser “knows” what type of patch it is). This is because instrument patches and effect patches are fundamentally different - instruments are played, and effects are used to process sound - and you would logically browse for one or the other, but not both.

- **When browsing patches from an existing instrument device, including instrument Combinators, no effects patches are shown in the Browser list.**
- **When browsing patches from an existing effect device, including effect Combinators, no instrument patches are shown in the Browser list.**
- ! **When browsing Insert FX patches for an audio track, Mix Channel or the Master Section, cross-browsing is not possible (you can only load effect Combinator patches).**

## Cross-browsing - an example:

1. You are playing a Subtractor device but feel that the sound isn't quite what you had in mind, so you click the Browse Patch button on the Subtractor to set Browse focus and check out some other patches.
2. After browsing Subtractor patches for a while, you still haven't found the type of sound you wanted, so you click the Root Folder drop-down list and select “Reason Factory Sound Bank” from the list:

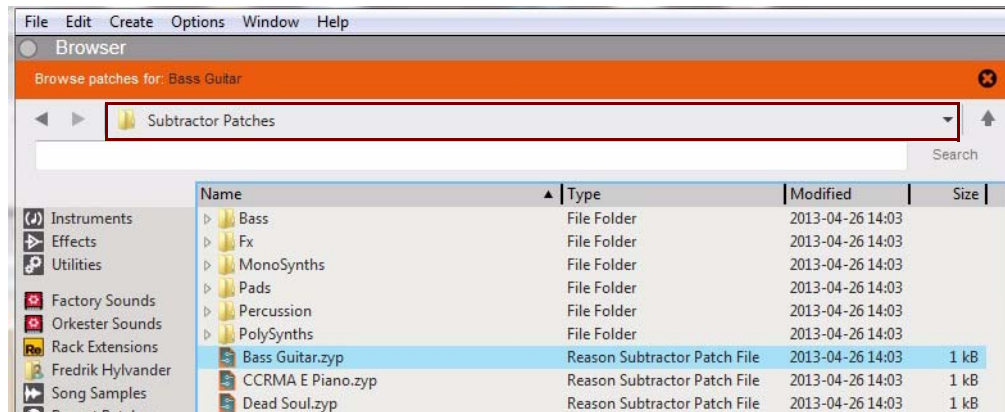

From here you can select instrument patches for any device. You decide to browse a folder containing Malström patches.

3. **As soon as you load a Malström patch from the Browser, a Malström device replaces the Subtractor device in the rack.**

The sequencer track which was previously assigned to the Subtractor is now assigned to a Malström with the selected patch loaded.

- **The name of the sequencer track and the Mix Channel device (and channel strip in the main mixer) are automatically changed to the Malström patch name.**
- ! **Note that is only true if you haven't manually renamed the sequencer track earlier. If you renamed the sequencer track earlier, it will keep this name regardless of what device or patch you load. However, if you delete the custom name, the sequencer track and Mix Channel device will show the patch name again.**

→ **You can continue to browse and load patches and play your keyboard to try them out.**

Each time you load a patch that belongs to a different device, this device automatically replaces the previous device in the rack.

- **Cross-browsing for an effect patch it works in the same way - loading an effect patch of a different format will replace the current effect device in the rack.**

## Special instances of cross-browsing

There are a few instances when replacing an existing device by loading other device patches might lead to lost cable connections in the rack:

- **When a device is replaced by another device type, audio connections may be lost.**

An example is replacing an NN-XT, which can use up to 16 audio outputs, with a Subtractor which only has one audio output.

- **When a device is replaced by another device type, CV connections on the back panel may be lost.**

The only connections that are retained between device types are Sequencer Control CV/Gate in.

- ! **If you encounter such situations and you want to restore the original connections, use the “Undo” function. Browsing back to the original device patch will not restore lost connections.**

## Create Instrument/Create Effect

These functions allow you to browse for any kind of instrument or effect patches. This is essentially the same as cross-browsing, except that you do not start with an existing device. The “Create Instrument/Effect” functions are very useful if you’re looking for a specific type of sound or effect but don’t know, or don’t care, what devices are used. For example, you might be looking for a “pad” sound or a “delay effect”. Once you’ve found what you’re looking for, you can just load the sound or effect in the required device(s).

1. **Select “Create Instrument...” or “Create Effect...” from the Create menu.**

The Browser opens. Depending on your selection, only Instrument Patches or Effect Patches are shown.

2. **When you load a patch, a corresponding device is created automatically.**

If you load an instrument device patch, a corresponding sequencer track will also be automatically be created. If an “empty” Mix Channel device isn’t available in the rack, a new one will be automatically created - with its channel strip in the Main Mixer. The instrument device will be automatically connected to the Mix Channel device. Master Keyboard input will be set to the new track so that you can play the patch from your master keyboard. The sequencer track, Mix Channel and channel strip in the Main Mixer automatically gets the name of the loaded patch.

## About patch formats and sampler devices

As both the NN-XT and NN19 sampler devices can load patches in the NN19 (.smp) and REX (.rx2/.rcy/.rex) formats, there must be certain rules regarding cross-browsing.

- **The basic rule is that the Browser will load such patches into the original device type (the device you opened the browser from), whenever possible.**

Thus, when the patch format is NN19 (.smp) or REX (.rx2/.rcy/.rex) and the NN19 device has browse focus, the patch will be loaded into this device.

- **If you are browsing from any other type of device, these patch types will be loaded into an NN-XT device.**

- **If you are using the “Create Instrument” function, an NN19 (.smp) patch will create a NN19 device and a REX patch will create a Dr. Octo Rex device.**

## Using the “Search” function

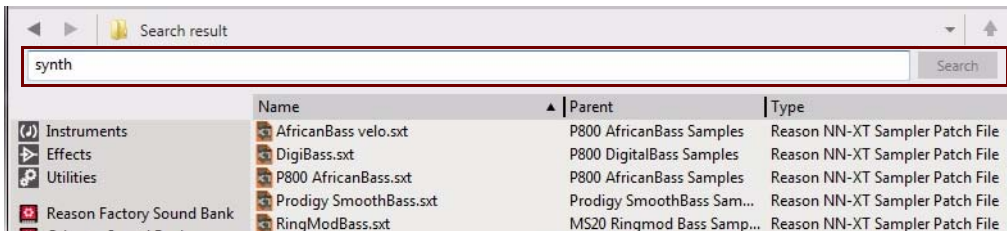

The Search function allows you to search for patches, songs, audio files etc. The Search field is always available at the top of the Browser.

→ **Type in a search text and click the Search button.**

- **The search happens in the currently shown folder/location (shown above the Search field) - and in all its sub folders (if any).**

The Root folder popup above the Search field shows "Searching <location>" where location is the current search folder. The search looks for items (including folders and ReFills) with matching names. We don't show the contents of a folder with matching name - we show the folder itself.

- **If you like you can change the search location/folder and redo the search in the new location/folder.**
- **If the search takes a while, an alert window appears with a progress bar and a Stop button.**

### The search result view in the Browser list

- **The search result is shown in alphabetical order as a flat list with files and folders whose names match the search string.**

If there are no search hits, the Browser list is empty.

- **A new “Parent” column also appears, listing the name of the parent folder for each file in the Browser list.**

If you select a file in the Browser list, you can pull down the “Root Folder” drop-down list and select “Go to Parent folder” - this opens the parent folder for the selected file.

To go back to the search result Browser list, click the Back button:

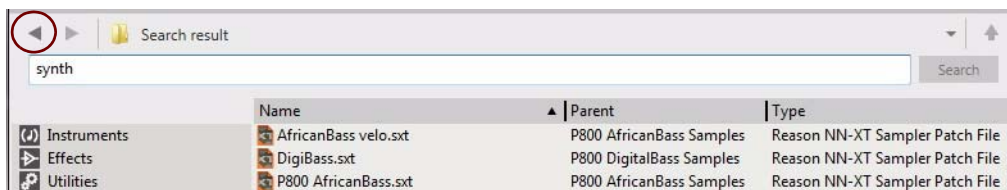

- **When searching in the Instruments/Effects/Utilities palette, the search result view shows matching devices only, not the manufacturer headings.**

## Loading files

When you have navigated to the desired folder (on your hard disk or within a ReFill) and located the desired file, you load it by double clicking it in the Browser list, or by selecting it and clicking the Open/Load/Create/Import button. The name of the button differs depending on what command you used for locating the file.

- **Once you have loaded a patch into a device (that now has browse focus), you can select and automatically load new patches by pressing the up/down arrow keys on your computer keyboard.**

## About browse lists

When you click the Open/Load/Create/Import button to open a file from the Browser, the file and folder list shown at that time is memorized for that device. This is called a “browse list”.

For patches (and to a certain extent samples) this list provides a specific functionality:

- **The browse list is what applies when changing patches using the Next/Previous Patch buttons on the front panel of a device (or from patch selectors on a control surface).**
- **The browse list is shown as the patch list when you click in the patch name field for a device.**
- **For samples, the browse list applies when changing samples using the Next/Previous Sample buttons on the front panel of a sampler device.**

### What can a browse list contain?

- **When you load a patch or sample by clicking Load/Create/Import in the Browser, the resulting browse list will include the files contained in all currently open folders in the Browser.**

If you open the Browser (set Browse focus) again from the same device, the same file and folder structure is shown.

- **If you save the current song and reopen it, the items in the browse list will be shown as a “flat” list, and the “Root Folder” field will show “Document Browse List”.**

In these situations, the Browser will show the “Parent” column, listing the names of the source folders. The “Root Folder” drop-down list will also contain the item “Go to parent folder” for a selected file.

- **A browse list could also be a Search result, or a Favorites List.**

Favorites Lists provide a way of controlling/filtering which patches or samples will be available on a browse list for a device - see [“Using Favorites - a practical example”](#)!

- ! **Note that if you opened a patch after having used cross-browsing (see [“Cross-browsing patch files”](#)) or used the Search function (see [“Using the “Search” function”](#)), the active browse list could contain patches of different formats, and loading patches from the device panel could change the device type.**

# Handling Missing Sounds

Sampler patches, drum machine patches, Dr. Octo Rex patches, and SoundFonts contain references to samples - files on your hard disk. The same is true for songs that contain samples (in sampler or drum machine devices) or REX files. If any of these files have been moved, renamed or removed when you try to open the patch or song, Reason will alert you that files are missing by showing the “Missing Sounds” window. The “Missing Sounds” window also appears if patches in the song are part of a ReFill which has been moved, removed or is not installed on your computer:

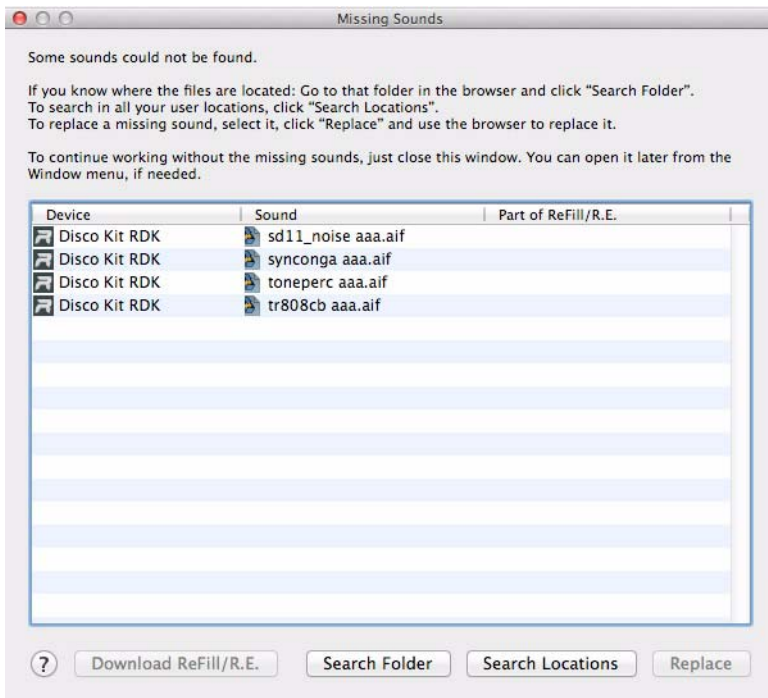

The “Missing Sounds” window.

The main display in the Missing Sounds window lists all missing files. The three columns show the following properties:

Column	Description
Device	Shows the name of the device in which the missing sound is used, along with a device type icon.
Sound	Shows the name of the missing file, along with a file type icon.
Part of ReFill/R.E.	If the missing file is part of a ReFill (or a SoundFont within a ReFill) or a Rack Extension device, this column shows the name of the ReFill/SoundFont/Rack Extension.

Below the main display are four buttons:

- **Select a file in the list and click the “Download ReFill/R.E.” button to open your web browser and download (and purchase, if necessary) the ReFill/R.E from the Propellerhead website.**
- **Click the “Search Folder” button to automatically search for and find the missing files in the currently selected folder in the Browser.**
- **Click the “Search Locations” button to automatically search for and find the missing files in any of the Locations present in the Browser.**



**! If you have a lot of ReFills and folders in your Locations, the search could take a while.**

If you want to abort the search, click the Cancel button in the “Searching...” window:

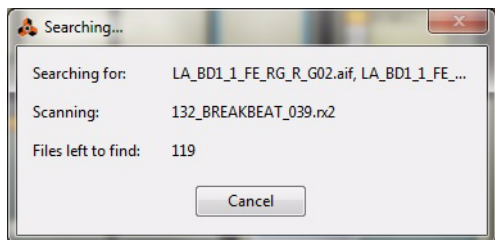

When you have found the sound you want to replace the missing sound with, double click it or select it and click the Replace button in the Browser:

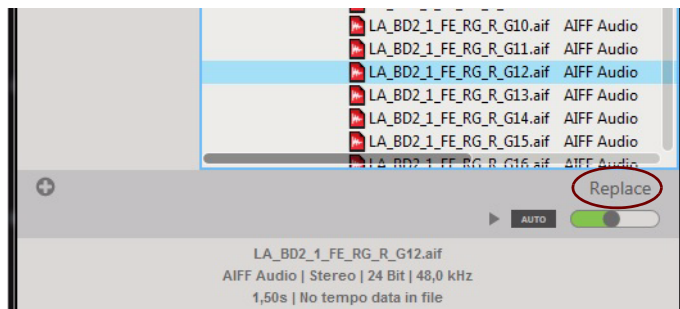

*Replacing a missing sound.*

The selected missing sound in the Missing Sounds window now disappears from the window and you can select the a new missing sound to replace.

- **If you want to replace a missing sound without searching for it, select the missing sound in the list and click the “Replace” button. Then use the Browser to select and replace the sample.**

If you like, you could replace missing sounds with new sounds - it doesn't have to be the original ones. When you save the Patch or Song later on, the new sounds will permanently replace the previous (missing) sounds.

- **Alternatively, close the Missing Sounds window.**

The song or patch will still work, but with sounds missing. This means that sampler patches, drum machine patches and/or loop players will not play back correctly.

On the panels of the concerned devices, missing samples are indicated with an asterisk (\*) before the file names:



*A Redrum device with a missing sample in one of its slots.*

- **If you want to continue searching for and replacing missing sounds later on, you can open the Missing Sounds window again by selecting “Show Missing Sounds Window” from the Windows menu.**

## Reason file formats

The following table lists the file formats that you can browse and open using Reason's browser:

File type	Extension	Description
Reason Song	.reason or .rns	This is the main document format in Reason. It contains the recordings on all audio, instrument and automation tracks - and the device setup in the rack, along with references to any used instrument samples and loops - or it can contain the actual samples and loops if you have made the song "self-contained" (see <a href="#">"About Self-Contained Songs"</a> ). Opening a Reason Version 5 (or earlier) song will retain the original rack configuration, but will route the signals originally connected to the Out 1 and 2 of the Reason Hardware Interface to a new Mix Channel (see <a href="#">"About opening Reason Version 5 (or earlier) Songs in Reason Version 8"</a> ).
Reason Demo Song	.rsndemo	A Reason Demo Song is a factory made song intended to demo the sound and features of the Reason program. Reason Demo Songs, Reason Essentials Demo Songs and Record Demo Songs are the only song file types that can be opened when you run Reason in Demo Mode (without authorization). See <a href="#">"Opening a Reason Demo Song"</a> .
Reason Published Song	.rps	A Reason Published Song is a self-contained Reason song (created in Version 5 or earlier) intended for playback only. It can only be opened in Reason and cannot be changed. Its components cannot be extracted and it is only possible to export the song as an audio file if you haven't edited anything. Opening a Reason Published Song song in Reason will retain the original rack configuration, but will route the signals originally connected to the Out 1 and 2 of the Reason Hardware Device to a new Mix Channel (see <a href="#">"About opening Reason Version 5 (or earlier) Songs in Reason Version 8"</a> ).
Reason Adapted Song	.rsb	A Reason Adapted Song is a song created in a Reason Adapted version. Opening a Reason Adapted Song in Reason will retain the original rack configuration, but will route the signals originally connected to the Out 1 and 2 of the Reason Hardware Device to a new Mix Channel (see <a href="#">"About opening Reason Version 5 (or earlier) Songs in Reason Version 8"</a> ).
Record Song	.record	This is the main document format in Propellerhead Record. It contains the recordings on all audio, instrument and automation tracks - and the device setup in the rack, along with references to any used instrument samples and loops - or it can contain the actual samples and loops if the song is "self-contained" (see <a href="#">"About Self-Contained Songs"</a> ).
Record Demo Song	.recdemo	A Record Demo Song is a factory made song intended to demo the sound and features of the Propellerhead Record program. Record Demo Songs, Reason Demo Songs and Reason Essentials Demo Songs are the only song file types that can be opened when you run Reason in Demo Mode (without authorization). See <a href="#">"Opening a Reason Demo Song"</a> .
Reason Essentials Song	.ree	This is a song created in Reason Essentials. It contains the recordings on all audio, instrument and automation tracks - and the device setup in the rack, along with references to any used instrument samples and loops - or it can contain the actual samples and loops if the song is "self-contained" (see <a href="#">"About Self-Contained Songs"</a> ).
Reason Essentials Demo Song	.reedemo	A Reason Essentials Demo Song is a factory made song intended to demo the sound and features of the Reason Essentials program. Reason Essentials Demo Songs can be opened and edited in Reason just like a regular Reason Essentials Song.
Reason Limited Song	.rltd	This is a song created in Reason Limited. It contains the recordings on all audio, instrument and automation tracks - and the device setup in the rack, along with references to any used instrument samples and loops - or it can contain the actual samples and loops if the song is "self-contained" (see <a href="#">"About Self-Contained Songs"</a> ).
Combinator Patch	.cmb	The Combinator can store/recall combinations of Reason devices. Combinator patches (Combi) will save all panel settings (as well as sample references if used) for all devices that are part of the Combi. In addition, all routing (audio/CV) between devices in the Combi are included in the patch. Effect Combi patches are also used for Insert FX patches in the Main Mixer.
Subtractor Patch	.zyp	This is a patch for the Subtractor synth device, containing all panel settings. You store your synth sounds by saving Subtractor patches.
Thor Patch	.thor	This is a patch for the Thor synth device, containing all panel settings. You store your synth sounds by saving Thor patches.

File type	Extension	Description
Malström Patch	.xwv	This is a patch for the Malström synth device, containing all panel settings. You store your synth sounds by saving Malström patches.
NN19 Sampler Patch	.smp	This is a patch for the NN19 Sampler device, containing references to and settings for all used samples, along with panel settings.
NN-XT Sampler Patch	.sxt	This is a patch for the NN-XT Sampler device, containing references to and settings for all used samples, along with panel settings.
Redrum Patch	.drp	This is a patch for the Redrum drum machine device. It contains information about which drum samples are used, along with all drum sound settings. In effect, a Redrum patch is a stored drum kit.
Dr. Octo Rex Patch	.drex	This is a patch for the Dr. Octo Rex Loop Player device. It contains information about which REX Loops are used, along with all loop and panel parameter settings.
Kong Kit Patch	.kong	This is a patch for the Kong Drum Designer device. It contains information about what drum samples/modules are used, along with all drum sound settings for all 16 channels. In effect, a Kong Kit Patch is a complete stored drum kit.
Kong Drum Patch	.drum	This is a patch for a single Drum channel in the Kong Drum Designer device. It contains information about which drum samples/modules are used, along with all drum sound settings for one single Drum channel.
RV7000 Patch	.rv7	This is a patch for the RV7000 reverb effect, containing all panel settings.
Scream 4 Patch	.sm4	This is a patch for the Scream 4 distortion effect, containing all panel settings.
Line 6 Amp Tone	.l6t	This is a patch for the Line 6 Amp devices in Reason. It contains all panel settings as well as information about used Amp and Cabinet models.
The Echo Patch	.echo	This is a patch for The Echo delay effect, containing all panel settings.
Pulveriser Patch	.pulver	This is a patch for the Pulveriser effect, containing all panel settings.
Alligator Patch	.gator	This is a patch for the Alligator gate effect, containing all panel settings.
REX files	.rx2, .rcy or .rex	<p>REX files are created in another Propellerheads application, the ReCycle loop editor. REX files contain audio loops chopped into slices, with one slice for each significant beat in the loop.</p> <p>REX files can be imported to Audio Tracks in Reason and are automatically converted to audio files. By loading a REX file into the Dr. Octo Rex Loop Player device, you can play back the loop in virtually any tempo (without affecting the pitch), manipulate individual beats in the loop, extract timing info, etc.</p> <p>Note that you can also load REX files into the samplers, the Redrum drum machine and Kong Drum Designer.</p>
Audio files and Samples	.wav, .aif, mp3 etc.	<p>Audio files of various formats, resolutions and sample rates can be imported to Audio Tracks in Reason. All sampler devices in Reason can also load and play back samples and audio files in these formats. You can use files of different formats in the same device - one drum sound can be an 8-bit sample, the next a 16-bit sample, etc.</p> <p>The audio file format support differs depending on which computer OS you are using.</p> <p>In Mac OSX10.7, the following audio file formats are supported:  .wav (not floating point), .aiff (not floating point), .3g2, .3gp, .mp1, .mp2, .mp3, .mpeg, .mpa, .snd, .au, .sd2, .ac3, .aac, .adts, .amr, .caf, .m4a, .m4r and .mp4.</p> <p>In Windows 7, the following audio file formats are supported:  .wav (not floating point), .aif (not floating point), .mp3, .aac, .m4a and .wma</p>

File type	Extension	Description
SoundFont Bank	.sf2	<p>The SoundFont format was co-developed by E-mu Systems and Creative Technologies and is used with many audio cards and software synthesizers. SoundFont banks store wavetable synthesized sounds, allowing users to create and edit multi-sampled sounds in special Soundfont editing programs. The SoundFonts can then be played back in wavetable synthesizers, typically on audio cards, thereby effectively turning an ordinary sound card into a sampler.</p> <p>The NN-XT and NN19 Samplers and the Redrum drum machine allow you to browse and load SoundFonts. Regardless of which editing program was used to create them, these banks are similarly and hierarchically organized, with folders for instruments, presets, samples etc. The NN-XT, NN19 and the Redrum lets you load individual samples and presets from a SoundFont bank, but <i>not</i> the complete SoundFont.</p>
Rack Extension Patch	.repatch	<p>These are patches for Rack Extension devices. All Rack Extension devices use the same file extension but the patch files contain different data depending on which device was used for creating them.</p>

# **Chapter 14**

## **Routing Audio and CV**

# About this chapter

This chapter describes the various signals used in Reason and how you can route them.

## Signal types

The following signal types are used in Reason:

### Audio signals

Besides the Spider CV, Matrix Pattern Sequencer and the RPG-8 Arpeggiator, all Reason devices have audio connectors on the back. The audio connectors carry audio signals to or from devices via virtual cables.

- **Audio connectors are shown as large quarter inch jacks.**
- **Audio Effects devices, which are used to process audio, have both audio inputs and outputs.**
- **Instrument devices, which generate audio, have either mono or stereo left/right audio output connectors.**  
You do not have to use both outputs for devices with stereo outputs. Use the left output to use a mono signal from a stereo device.
- **To monitor audio outputs from devices, the signals can be routed, either via the Main Mixer or directly, to the physical outputs of your audio interface via the Reason Hardware Interface (see “Manual audio routing”).**  
Typically, if you are using an audio interface with stereo outputs, you will most likely use the Main Mixer to mix the audio signals to the master outputs.
- **To route audio input signals from your audio interface to audio tracks in the sequencer, you just have to select the appropriate input(s) from the Audio Input drop-down list on the corresponding audio track (see “Selecting audio input(s) and defining mono or stereo”).**  
This means that you never have to manually patch input signals from the Audio In jacks of the Reason Hardware Interface.

For more information about signal paths in Reason, see “System signal paths”.

### CV/Gate signals

In the early days of synthesizers, before the MIDI protocol was invented, analog synthesizers could be interconnected using Control Voltage (CV) cables. For example, one cable would be used for controlling pitch while another would send a Gate voltage, basically telling a synth when to play a note and when to stop. The CV signal cables in Reason emulate this analog control system. CV signals are typically used to modulate parameter values, and do not carry audio.

- **CV/Gate connectors are shown as smaller mini jacks.**
- **CV is typically used for modulation purposes.**  
For example, you could modulate a parameter with a CV signal generated by an LFO or an envelope generator on another device.
- **Gate outputs/inputs are typically used to *trigger* events, such as note on/off values, envelopes etc.**  
Gate signals produce on/off values, plus a “value” which could be likened to (and used as) velocity.
- **You can only route CV/Gate signals from an output to an input (or vice versa).**  
You cannot route an input to another input or an output to another output.

## P-LAN signals

P-LAN is the internal system used for routing audio signals from Mix Channel and Audio Track devices to the Main Mixer Master Section device - and from Mix Channel/Audio Track devices to other Mix Channel devices that are used as Output Busses (sub-mixers).

P-LAN connections are not indicated by cables or similar in the rack - only by an Audio Output display on the front and rear of Mix Channel and Audio Track devices:



*P-Lan signal destinations on Mix Channel and Audio Track devices (front and rear).*

If you use the Direct Out jacks on an Audio Track device or Mix Channel device, the internal P-LAN connection is broken. In this case, the audio from the Mix Channel/Audio Track device is not sent to the Master Section.

## About MIDI routing

Normally, MIDI (e.g. note and performance data) are sent to devices from their respective sequencer track. No cables are used in the rack to indicate MIDI connections.

For other ways to route MIDI to devices, see the chapters [“Remote - Playing and Controlling Devices”](#), [“Synchronization and Advanced MIDI”](#) and [“External MIDI Instrument”](#).

## About cables

### Cable appearance

If there are many connections in Reason, the cables can sometimes obscure the view, making it difficult to read the text printed on the back panels of the devices. Cables can be displayed in “normal” mode and in “Reduced Cable Clutter” mode.

→ **Toggle cable display mode by pressing [K] or by selecting “Reduce Cable Clutter” on the Options menu:**

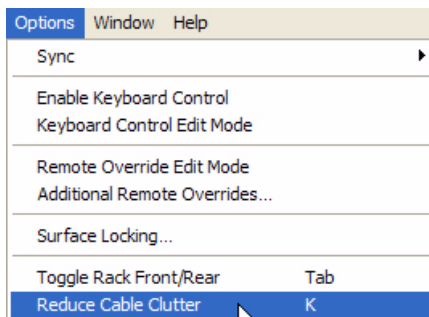

- In “normal” mode, i.e. with the option “Reduce Cable Clutter” deselected, all cables for all devices are displayed at the back of the rack.

- With **“Reduce Cable Clutter”** selected, the cable appearance depends on the settings in the **“Appearance”** section on the **“General”** page in Preferences:

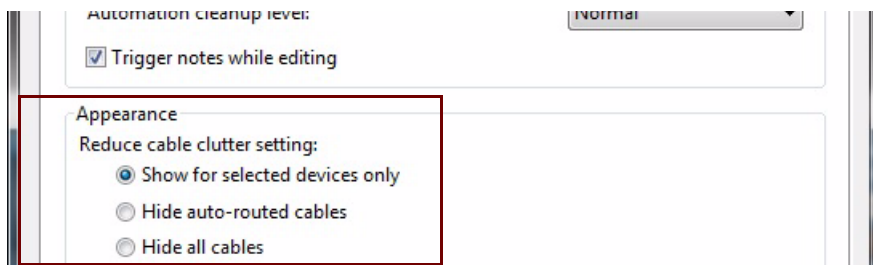

- **Select “Show for selected devices only” to only display the cables for selected devices.**  
All other (non-selected) devices will have “transparent” cables to make it easier to distinguish the cables of selected devices.
- **Select “Hide auto-routed cables” to only display manually routed cables.**  
All devices with auto-routed cables will have “transparent” cables to make it easier to distinguish the manually routed cables.
- **Select “Hide all cables” to hide all auto-routed and manually routed cables.**  
All cable connections on devices will be indicated with colored dots in the jacks, and no cables will be displayed.



*“Reduce Cable Clutter” selected with the “Hide All Cables” appearance.*

- In **“Reduced Cable Clutter”** mode, it’s still possible to connect and disconnect cables in the same way as when they are shown.  
See [“Manual routing”](#) for a description of routing methods.

## Checking and following cable connections

You can always check to which device a jack is connected. This is especially useful if the patch cables are hidden, but it is also practical if you have a lot of cables in your rack, or if the two connected devices are far from each other in the rack:

- **Hover with the pointer over a connector and wait a moment.**  
A tool tip appears, showing both the device name and connector that the cable is connected to.



## About the “Scroll to Connected Device” function

It’s possible to scroll directly to a connected device as follows:

1. **Click and hold (or right-click (Win) or [Ctrl]-click (Mac)) on a connector.**  
A pop-up menu appears.
2. **Select “Scroll to Connected Device” from the pop-up menu.**  
The device in the other end of the cable will be scrolled into view in the rack.



## Cable color

To allow for a better overview of the connections in the rack, the cables have different colors:

**Green cables indicate effect device connections.**

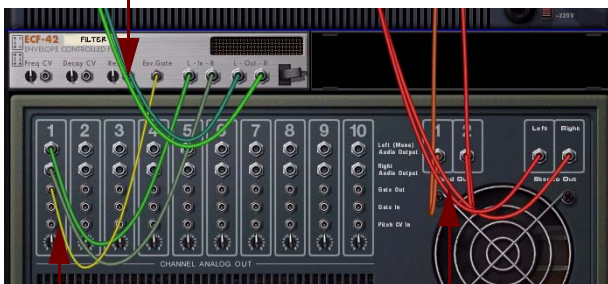

**Yellow cables indicate CV connections.**

**Red cables indicate connections between instrument and mixer devices.**

- Audio connections between instrument and mixer devices are different shades of red.
- Connections to and from effect devices are different shades of green.
- CV connections are different shades of yellow.
- Combinator connections are blue.

## Automatic routing

Auto-routing enables the automatic routing of cables between devices according to certain rules. Auto-routing is performed under the following circumstances:

- When you create a new (Empty) Song, the Master Out L & R on the Master Section device are by default connected to Outputs 1 & 2 of the Reason Hardware Interface.
- When a new device is created.
- When moving, duplicating or pasting devices with [Shift] pressed.
- When selecting “Auto-route Device” from the Edit or context menu, with one or several devices selected in the rack.
- Audio input signals from the Reason Hardware Interface to the audio tracks in the sequencer are automatically routed “in the background”.

When applicable, auto-routing is performed in stereo.

## Auto-routing of audio input signals

- Available audio inputs on your installed audio interface are auto-routed from the Hardware Interface to audio tracks in the sequencer “in the background”.

This means that no patch cables are necessary for routing audio to audio tracks in the sequencer.

# Auto-routing of Instrument devices

## Routing to the Main Mixer

- **When you create an instrument device, it is automatically connected to a new Mix Channel device in most situations.**  
However, if the instrument device is created directly below an unused (no inputs connected) Mix Channel device in the rack, it will be connected to this instead.

## Routing to the Mixer 14:2 or Line Mixer

- **If a Mixer 14:2 or Line Mixer 6:2 is selected when you create an Instrument device, or if you create an Instrument just below the mixer device in the rack, the instrument will be auto-routed to the first available inputs on the mixer device.**

# Auto-routing of Effect devices

## Routing as a Main Mixer insert effect

- **When you have a Mix Channel or Audio Track device selected and create an effect device, it will be automatically connected as an insert effect in the Mix Channel/Audio Track device. See “Adding Insert effects”.**
- ! **The above does not apply to the Master Section device - see below!**
- **It’s also possible to select Effect Combi patches as insert effects - see “Loading Effect Combi patches”.**

## Routing as a Main Mixer Master Section insert effect

Routing an effect device as an insert effect in the Master Section device can be done in the following ways:

1. **Click the “Show Insert FX” button on the Master Section device and then click inside the Insert FX container.**  
A red insertion line is shown.

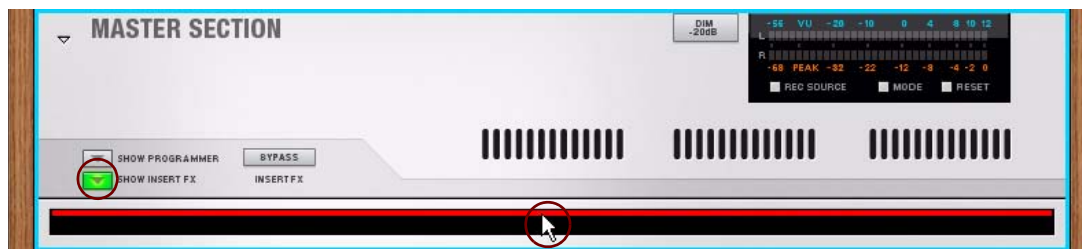

2. **Create an effect device from the Create menu, or by selecting it from the device context menu, or by double-clicking on the device in the “Devices” tab in the Tool Window.**  
The device will be automatically connected as an insert effect in the Master Section device.
- **By dragging and dropping an effect device from the “Devices” tab in the Tool Window to the open Insert FX container in the Master Section device, it will be automatically connected as an insert effect.**
  - **It’s also possible to select Effect Combi patches as insert effects in the Master Section - see “Loading Effect Combi patches”.**

## Routing as a Main Mixer Master Section send effect

- When you have the Master Section device selected and create an effect device, it will be automatically connected as a send effect to the first available Send FX connectors on the Master Section device. See **“Creating Send effects”**.
- It’s also possible to use the **“Add Send FX”** function to add effect devices or Effect Combi patches as send effects in the Master Section - see **“Creating Send effects”**.

## Routing directly to another device

- When you have an instrument device selected and create an effect, that effect will be connected as an **“insert” effect between the instrument device and the Mix Channel/mixer device**.  
Examples of effects that work well as insert effects are distortion, compression and modulation effects.

## Routing as a send effect to a mixer device

- When you have a mixer device (the Mixer 14:2 or Line Mixer 6:2) selected in the rack and create an effect device, it will be automatically connected as a send effect (to the first free Aux Send/Return jacks).

## Auto-routing of CV/Gate signals

### The Matrix Pattern Sequencer

- When you have an instrument device (Subtractor/Thor/Malström/NN-19/NN-XT/Combinator) selected and create a Matrix Pattern Sequencer, the Note and Gate CV signals will be auto-routed to the instrument device. The Matrix Note and Gate CV outputs are automatically connected to the Sequencer Control CV and Gate inputs on the instrument device, respectively.

### The RPG-8 Arpeggiator

- When you have an instrument device (Subtractor/Thor/Malström/NN-19/NN-XT/Combinator) selected and create an RPG-8 Arpeggiator, the Note CV, Gate CV, Mod Wheel and Pitch Bend signals will be auto-routed to the instrument device. The RPG-8 Note CV and Gate CV outputs are automatically connected to the Sequencer Control CV and Gate inputs on the instrument device, respectively. The RPG-8 Mod Wheel and Pitch Bend outputs are automatically connected to the Modulation Inputs Mod Wheel and Pitch Bend inputs on the instrument device, respectively.

## Auto-routing devices after they have been created

Some additional rules regarding auto-routing devices that are already in the rack:

- To reroute a device already in the rack, you can select it and choose **“Disconnect Device”** and **“Auto-route Device”** from the Edit menu or context menu.  
When you use **“Auto-route Device”** it will be connected in a logical way according to its current location in the rack.
- If you hold [Shift] and drag a device to a new position in the rack, it will be re-routed (as if you deleted it and created it in its new position).  
This allows you to e.g. change the order of effect devices in a signal chain by Shift-dragging them.
- If you delete a device connected between two devices, the connection between the two remaining devices is preserved.  
A typical example might be if you have an effect device connected between an instrument device and a Mix Channel device. If you delete the effect device, the instrument device will be re-routed directly to the Mix Channel device.

- **When you move a device in the rack, the connections are not affected.**
- **When you duplicate devices by dragging and dropping, or using copy and paste, the devices are not auto-routed.**  
If you would like them to be auto-routed, hold down [Shift] while performing the operation.
- ! **If you are duplicating a complete Device Group (see “[Duplicating devices](#)”), this will often include a Mix Channel. In this case, the Mix Channel will also be duplicated, with no need for further auto-routing.**

## Bypassing Auto-Routing

- **If you wish to create a new device without any auto-routing taking place, press [Shift] when creating the device.**

## About re-routing devices in songs created in Reason Version 5 or earlier

If you open a Reason song, created in Reason Version 5 or earlier, the song will open with the outputs of the Mixer 14:2 connected to the inputs of a single Mix Channel device in Reason Version 8. To make better use of the Main Mixer in Reason Version 8, you will have to re-route all instrument devices in the older Reason song to separate (new) Mix Channels in Reason Version 8. To make this re-routing a little easier, proceed as follows:

- 1. Open the older (Version 5 or earlier) Reason song in Reason Version 8.**
- 2. Delete the Mixer 14:2. \***
- 3. Select "Select All" from the Edit menu to select all devices.**
- 4. Select "Auto-route Device" from the Edit menu.**

This will create a Mix Channel device for each instrument in the old Reason song, keeping any connected effect devices in the signal chain.

\* If you have send effects connected to the Mixer 14:2, you will need to re-route them manually to the Main Mixer Master Section device. You might also want to make a note of fader and pan settings on the Mixer 14:2 before deleting it.

# Manual routing

To connect devices manually, you need to flip the rack around to see the back. This is done by pressing [Tab] or by selecting “Toggle Rack Front/Rear” from the Options menu.

Note that routing cables can be done regardless of the “Reduce Cable Clutter” setting on the Options menu. This means that you can connect cables even though they are hidden (see “Cable appearance”).



On the back of each device you will find connectors of two different types: audio and CV (Control Voltage, used for controlling parameters - see “Using CV and Gate”). Audio inputs and outputs are shown as large quarter inch jacks, while CV input and output jacks are smaller. For now, we’ll stick to the audio connections.

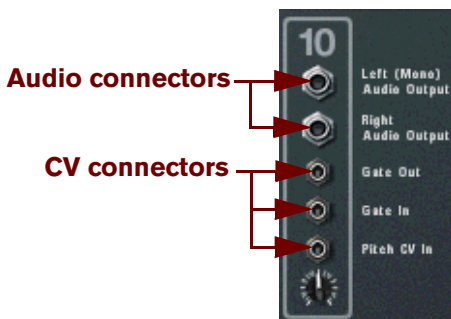

*Audio and CV connectors.*

- When the back of the rack is shown, you can still navigate in the rack by scrolling or by using the computer keyboard.

There are two ways to route signals from one device to another:

- By connecting virtual patch cables between inputs and outputs.
- By selecting connections from a pop-up menu.

## Connecting cables

1. **Click on the desired input or output jack on one of the devices, and drag the pointer away from the jack (with the mouse button pressed).**

A loose cable appears.

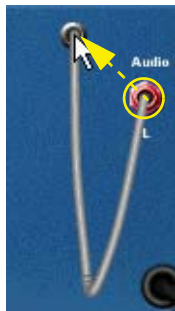

2. **Drag the cable to the jack on the other device.**

When you move the cable end over a jack of the correct type (audio/CV, input/output) it will be highlighted to show that a connection is possible.

3. **Release the mouse button.**

The cable is connected. If both input and output are in stereo and you connect the left channels, a cable for the right channel is automatically added.

- ! **Dragging a cable to make a connection can be aborted by pressing [Esc] while keeping the mouse button pressed.**
- **You can change an existing connection in the same way, by clicking on one end of the cable and dragging it to another connector.**

## Connecting cables using pop-up menus

1. **Click and hold (or right-click (Win) or [Ctrl]-click (Mac)) on a connector.**

A pop-up menu appears, listing all devices currently in the rack.

2. **Move the pointer to the device you want to create a connection to.**

A sub-menu appears, listing all suitable input/output connections. For example, if you clicked on an audio output on a device, the hierarchical sub-menus will list all audio inputs in all other devices.



- **If a device is grayed out on the pop-up menu, there are no suitable connections on the device.**
  - **An asterisk (\*) next to the connector name on the sub-menu indicates that the connection is already occupied.** It's possible, however, to select an occupied connection. Doing so will disconnect the existing connection and replace it.
3. **Select the desired connector from the submenu.**  
The connection is created.

## Disconnecting cables

There are two ways of manually disconnecting cables:

- **Click on one end of the cable, drag it away from the jack and drop it anywhere away from a jack.**
- **Click and hold (or right-click (Win) or [Ctrl]-click (Mac)) on a connector and select “Disconnect” from the pop-up menu that appears.**



## Disconnecting devices

It's also possible to disconnect all cables from selected devices in one go:

- **Select the device(s) and then choose “Disconnect Device” from the Edit menu or device context menu.**  
All cables on the selected device(s) are now disconnected simultaneously.

# Using CV and Gate

CV/Gate is used for modulating and triggering device parameters. Each separate Device chapter lists the available CV/Gate connections and the parameters that can be modulated or used for modulation outputs for that device.

## Routing CV and Gate signals

There are not really any hard and fast “rules” applicable to CV/Gate routing. A few points should be mentioned, though:

- **The specific “Sequencer Control” inputs present on the Subtractor, Thor, Malström, NN-19 and NN-XT sampler devices are primarily intended for controlling these devices as (monophonic) instruments from the Matrix Pattern Sequencer or the RPG-8 Arpeggiator.**  
If your intention is to use the Matrix or the RPG-8 CV/Gate outputs to create melodic patterns using these Instrument devices, you should use the Sequencer Control inputs.
- **The Matrix Pattern Sequencer can be used in many other ways, besides creating melodic patterns. For example you could use it to modulate any CV controllable parameter, with the added advantage of the modulation being synchronized to the tempo.**
- **Conversely, if you would like to apply Gate or CV modulation to more than one voice, you should *not* use the Sequencer Control inputs, as these only function monophonically.**
- **Feel free to experiment: Use Gate signals to control parameter values and CV signals to trigger notes and envelopes, if you like.**  
See the chapter “[Matrix Pattern Sequencer](#)” for more tips about using CV.
- **By routing CV to the rotary controls on a Combinator, you can CV control virtually any parameter on any device - see “[CV Connections](#)” in the Combinator chapter.**

## About CV Trim knobs

All CV inputs have an associated Trim knob. This is used to set the CV “sensitivity” for the associated parameter. The further clockwise a CV trim knob is set, the more pronounced the modulation effect.

- **Turned fully clockwise, the modulation range will be 100% of the parameter range (0-127 for most parameters).**
- **Turned fully anti-clockwise, no CV modulation will be applied.**



# **Chapter 15**

## **The Main Mixer**

# About this chapter

This chapter describes the various procedures, parameters and functions in the Main Mixer as well as the relationship between mixer channels and the Audio Track/Mix Channel devices in the rack. The chapter also covers how to set up and use Insert and Send effects, as well as some advanced routing tips and tricks.

## Overview



The Main Mixer is a fully equipped mixer with pro features to meet the most demanding mixing needs. You can have an unlimited number of channels, each with advanced eq and dynamics control.

The mixer can be viewed as a remote control for Audio Track and Mix Channel rack devices. This is where you control levels, make eq and effect settings etc., although the devices themselves “live” in the rack.

# The Audio Track, its device and mixer channel strip

Audio Tracks and their associated rack devices are for recording/playing back audio.

When you create a new Audio Track, a corresponding Audio Track device is added to the rack and an Audio Track channel strip is added to the Main Mixer.

The track, device and channel strip all belong together. If you delete the device, the corresponding track and channel strip are also deleted.

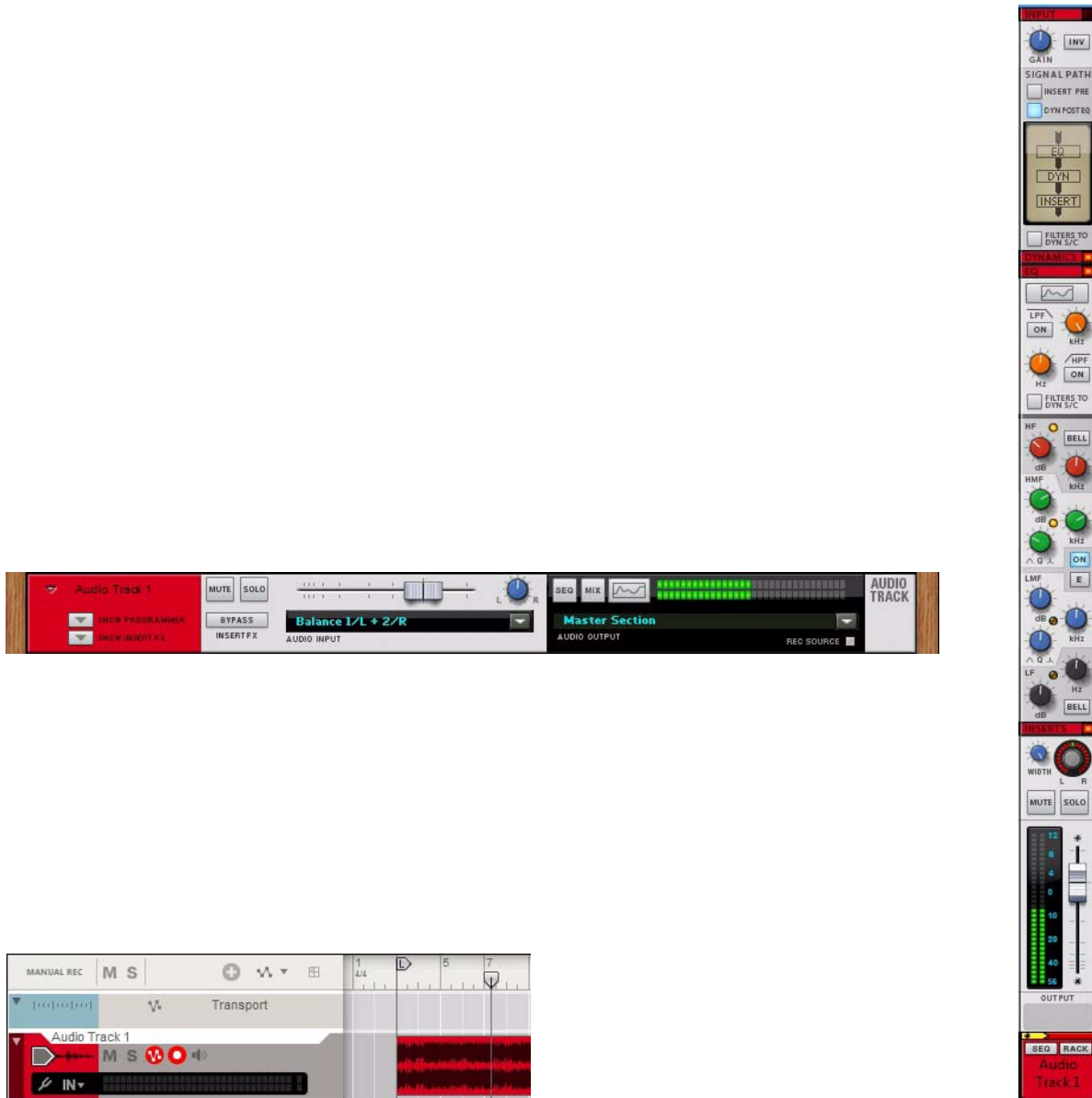

An Audio Track in the sequencer with its corresponding rack device and channel strip in the Main Mixer.

- **Audio Track devices have no audio inputs on the back - the audio is fed internally to the Audio Track device from the associated sequencer track.**

## The Mix Channel device and channel strip

A Mix Channel device acts as a host to a source device (e.g. an instrument device). When you create an instrument, a Mix Channel device is added automatically to the rack and a corresponding Mix Channel strip is added to the Main Mixer. You can also create Mix Channels manually from the Devices tab in the Tool Window or from the Create menu. This is useful if you need to make manual mixer routings - see [“Advanced routing tips and tricks”](#) at the end of this chapter.

The Mix Channel device has inputs to which the source (instrument) device is connected. The Mix Channel device and channel strip will automatically be assigned the name of the connected source device, but this can be changed - see [“Naming mixer channels”](#).

A Mix Channel device will not automatically have a corresponding track created in the sequencer (but the connected source device will). Mix Channel tracks are created manually and used for automating channel strip parameters - see [“Automating mixer parameters”](#).



*A Mix Channel device (with an ID8 source device connected) and the corresponding channel strip in the Main Mixer.*

## The Master Section device and mixer strip

The Master Section device is always present and is fixed in the rack, just below the Reason Hardware Interface. This is where all your Audio Track and Mix channels are summed and mixed to stereo, and where you set up your Send effects and Master Insert effects. For descriptions of how to set up and use effects, see [“Insert FX”](#) and [“Send FX”](#).

The corresponding Master Section mixer strip is also fixed and is always visible to the right in the Main Mixer.

The Master Section track is used for automating Master Section parameters - see [“Automating mixer parameters”](#).



*The Master Section device and mixer strip.*

# Navigating in the Main Mixer

## Viewing the Main Mixer area

There are several ways to bring the Main Mixer area into view:

- **By dragging the gray Rack header downwards to reveal the mixer area.**
- **By pressing [F5] on your keyboard or selecting “View Main Mixer” from the Windows menu.**
- **By clicking the Show/Hide icon on the gray Mixer header.**
- **To view the mixer in a separate window, either click the Detach icon on the Mixer header, select “Detach Main Mixer Window” from the Windows menu or hold down [Ctrl](Win) or [Cmd](Mac) and press [F5].**

## Scrolling and navigating in the Main Mixer

The Channel Strip Navigator and Mixer scrollbar allow you to navigate between channels in the Main Mixer or to focus on a specific channel strip area. The Channel Strip navigator area can be shown/hidden using the “Show Navigators” Options menu item.

The Channel Strip Navigator is the miniature mixer and channel strip area at the far right of the Main Mixer window. The blue rectangle shown inside the area acts much in the same way as a scrollbar in standard document windows. If you move the pointer inside the rectangle the pointer changes to a hand, allowing you to click and scroll. You can also click anywhere in the Navigator area to immediately get to the desired destination.

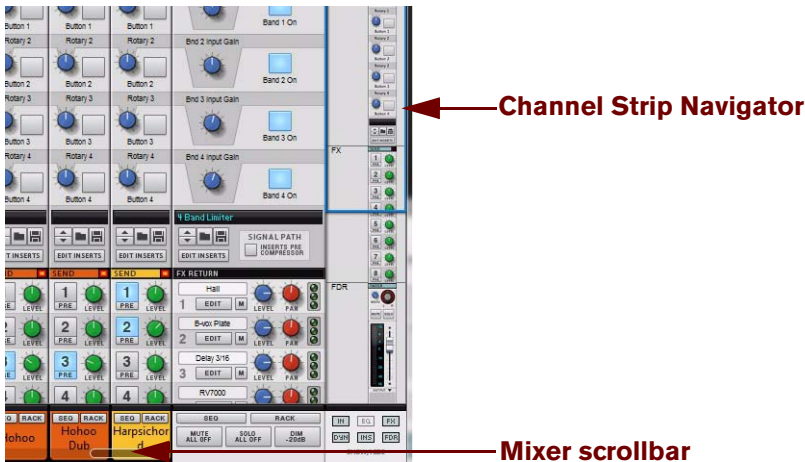

- **The Mixer scrollbar allows you to scroll between all the channels in the mixer.**  
The Mixer scrollbar will only show and scroll the regular channel strips - the Master Section is always visible and fixed to the right in the Main Mixer area.
- **The Channel Strip Navigator area allows you to scroll between the various channel strip sections (channel strip sections can also be hidden, see below).**  
All areas of the channel strips and Master Section can be scrolled, except the Channel Header section (the area below the faders) which is always visible at the bottom. If the Main Mixer is detached, the fader section is also always visible and stays at the bottom.
- **Alternatively, you can use a mouse scroll wheel or a trackpad to scroll.**
- **The [left]/[right] arrow keys can be used to move between channels**
- **The [Page Up]/[Page Down] keys can be used to scroll vertically.**
- **The [Home] and [End] keys will scroll the mixer to the leftmost and rightmost channel strip, respectively.**

## Showing and hiding channel strip sections

Channel strips are divided into sections, which can be globally shown or hidden in the mixer. This enables you to hide sections that you don't need to tweak or to focus on specific sections. Hiding a section does not alter the mixer functionality in any way, sections are still active when hidden.

Each section has a section name header in the channel strip. The sections are as follows (from the top down): Input, Dynamics, EQ, Inserts, FX Sends and Fader. (See “The channel strip” for descriptions of each section.)

The section headers are always visible even if a section is hidden, as is the channel header (name label) section below the faders. Note that if the Main Mixer is detached from the rack, the fader section cannot be hidden.



Section headers in the channel strip. A red light to the right of the section header name indicates that the section is in use for the channel. Here, all sections are hidden (except the Fader section), so that only the section headers are visible.

There are two ways to show/hide channel strip sections:

→ **By using the Show/Hide buttons in the bottom right corner of the Channel Strip Navigator.**

Each button enables you to show or hide the corresponding section. Hidden sections are indicated by grayed-out buttons. Hold down [Alt](Win) or [Option](Mac) and click on any of the buttons to show or hide all sections in one go. Hold down [Ctrl](Win) or [Cmd](Mac) and click on a button to show this section and hide all other sections.



The Show/Hide buttons. Here, the EQ section is hidden.

→ **By double-clicking a section header in the channel strip.**

This will also show or hide the corresponding section.

- **Showing/hiding channel strip sections affects all channel strips, including the Master Section strip.**

## Differences between the channel strips and the Master Section strip

Showing/hiding mixer strip sections also affects the Master Section strip. There are a few differences in the Master Section and the channel strip sections when using the Show/Hide buttons:

- **There is no Input section in the Master Section. If the Input section is shown, the Master Section will display a blank panel.**
- **The “EQ” Show/Hide button affects the FX Send section in the Master Section.**
- **The “FX Sends” Show/Hide button affects the FX Return section.**

## Switching between channels, rack devices and tracks

The RACK and SEQ buttons allow you to go to a channel's rack device or sequencer track directly from the Main Mixer. Both buttons are located in the Channel Header section of the Main Mixer:

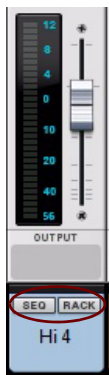

If you click the RACK button the following happens:

- **For Audio Track channels, this will bring the Audio Track rack device into view.**  
The rack area will be shown (if hidden) with the channel device in view.
- **For Mix channels, this will bring the Source device (i.e. the instrument device connected to the channel) into view.**  
[Shift]-clicking the RACK button for a Mix channel will instead bring the Mix Channel device into view.

The SEQ button allows you to go to a channel's sequencer track from the mixer. The SEQ button is also located in the Channel Header section. If you click the SEQ button the following happens:

- **For Audio Track channels, this will bring the Audio Track into view.**  
The sequencer area will be shown (if hidden) with the track in view.
- **For Mix channels, this will bring the track for the Source device into view.**  
[Shift]-clicking the SEQ button for a Mix channel will instead bring the Mix Channel automation track into view. If there isn't an automation track, one will automatically be created.
- **If you have previously deleted Mix Channel tracks and/or Audio tracks in the sequencer, clicking the SEQ buttons on the corresponding channel strips in the mixer will automatically create new sequencer tracks.**

To find the mixer channel for a specific track in the sequencer, or for a specific Mix Channel or Audio Track device in the rack, proceed as follows:

- 1. Select the track in the sequencer, or select the Mix Channel/Audio Track device in the rack.**
- 2. Bring the mixer into view.**

The channel will get Edit Focus (see “[Channel Header section](#)”) and be scrolled into view in the Main Mixer. If you have both the sequencer and Main Mixer in view, or the rack and Main Mixer, clicking a track in the Track List, or on a Mix Channel/Audio Track device in the rack, will flash the corresponding channel strip in the Main Mixer.



# Managing mixer channels

## Creating and deleting channels

Mixer channel strips are automatically created when you create Audio Track and Mix Channel devices. In most situations, a Mix Channel device (with its channel strip) is also automatically created when you create an instrument device (see [“Creating devices”](#)).

To delete a channel, proceed as follows:

- **Select the channel strip in the Main Mixer, or select its device in the rack, and press [Delete] or [Backspace].** Alternatively, select “Delete Channels and Tracks” from the Edit menu or context menu.

This will delete the channel strip, device and associated track. An alert appears asking you to confirm deletion.

If there are devices connected to the Mix Channel device you delete, and “Auto-group Devices and Tracks” is selected on the Options menu, the alert will ask if you want to delete only the selected device, or all devices in the Device Group (see [“About Device Groups”](#) for more information).

## Selecting channels

To select channels in the mixer you can use any of the following methods:

- **Clicking anywhere on a channel strip (including parameters) will select the channel.**  
If you are not editing parameters but want to select a channel, the channel header is a good place to click. You could also click anywhere on the channel strip background (where there are no parameters or displays).
- **If the Main Mixer has focus, you can use the left and right arrow keys to select channels.**  
The selection will move to the next adjacent channel (left or right) with each keystroke.
- **It is possible to select several channels, by using standard [Shift], or [Ctrl](Win) or [Cmd](Mac) selection techniques.**  
This allows you to e.g. move or delete several channels in one go. The last selected channel will be given edit focus which is indicated by a red strip in the channel header (see [“Channel Header section”](#)).
- **To select all channels, use the “Select All Channels” item on the Edit menu or channel strip context menu.**  
The Main Mixer must have focus for this item to be available.

## Moving channels

To move channels in the Main Mixer, simply select them and use standard drag and drop method. A red insertion line will show the insertion point, exactly like when moving devices in the rack or tracks in the sequencer.



*Moving a channel. The thicker red line indicates where the moved channel will be inserted.*

## Displaying channels, devices and tracks in the same order

Channel strips in the mixer, Audio Track and Mix Channel devices and tracks can be independently re-ordered. This allows you to set up the main work areas according to your preferences.

Should you wish to display mixer channels, devices in the rack and tracks in the same order, proceed as follows:

- 1. Select the area where everything is in the order you want reflected in the other areas.**

This could either be the Main Mixer, the sequencer or the rack.

- 2. Use the “Select All” Edit menu item.**

This menu item would be “Select All Devices” if the rack is selected, or “Select All Channels” if the mixer is selected. You could also select channels, tracks or devices manually.

- 3. Select the “Sort Selected Device Groups” Edit menu item.**

Channels, devices and tracks will now all be presented in the same order as the area you selected in the first step.

## Copying and duplicating channels

### Cut, Copy and Paste functions

Selected channels can be moved or copied using the “Cut/Copy/Paste Channels and Tracks” functions on the Edit menu or channel strip context menu. This allows you to copy one or several channels from one Song document to another. The following rules apply:

- **Cut and Copy affects all selected channels, and behaves according to the standard procedures.**  
Cut moves the channels to the clipboard, removing them from the rack, sequencer, and mixer, while Copy creates copies of the channels on the clipboard, leaving the originals as they were.
- **If the “Auto-group Devices and Track” option is activated on the Options menu, this will copy the channel’s entire Device Group, including tracks and clips - see “About Device Groups”.**
- **If no channel is selected when pasting, channels will be added to the left of existing channels in the Main Mixer.**  
If a channel is selected when pasting, the copied channel(s) will be inserted to the right of the selected channel.

## Duplicating channels

- **To make a duplicate copy of a mixer channel, with its settings and Insert FX (if any), hold down [Ctrl](Win) or [Option](Mac) and drag the channel to where you want it.**  
Several selected channels can be duplicated. You can also select “Duplicate Channels and Tracks” functions on the Edit menu or mixer context menu.
- **If the “Auto-group Devices and Track” option is activated on the Options menu, this will duplicate the channel’s entire Device Group, including tracks and clips - see “About Device Groups”.**

## Copy channel settings

If you wish to copy mixer channel settings from one channel to another you can use this function.

### 1. Select the channel you wish to copy settings from.

Copy channel settings only works when a single channel is selected, if several (or no) channels are selected the function is not available.

### 2. Select “Copy Channel Settings >” on the Edit menu or channel context menu.

On the submenu you can select to copy channel settings from a single section (Dynamics, Filters and EQ, Insert FX or FX Sends), or “All”, which copies everything including any Insert FX devices with their settings.

### 3. To paste the settings, select the channel you wish to copy channel settings to, then select “Paste Channel Settings” on the Edit menu or mixer context menu.

The type of settings you copied will be reflected in the paste menu item, e.g. “Paste Channel Settings: EQ” if you only copied the EQ section.

- **The copied channel settings remain on the clipboard (until you cut or copy again) so you can paste them to other channels if you so wish.**

This can only be done with one selected channel at a time - pasting channel settings is not possible if several channels are selected.

- **Copying channel settings can also be done by selecting an Audio Track or Mix Channel device in the rack.**

The procedure is the same. You can copy settings from a device to a mixer channel or vice versa.

## Resetting channel settings

Resetting channel settings initializes all channel strip parameters to default values and removes any insert effects (see “Insert FX section”) from the channel.

- **To initialize a mixer channel (or Mix Channel/Audio Track device), select “Reset All Channel Settings” from the Edit menu or channel/device context menu.**

Channel settings reset is not possible if several channels are selected.

- ! **Any Output Bus routings are not affected (see “Output Busses”).**

## Naming mixer channels

New Audio Tracks will by default be named “Audio Track + number”. When creating an Instrument, the Mix channel will take its name from the patch of the connected Instrument device.

- **To enter a new name for a channel, double-click the name in the channel header.**

A text field opens allowing you to enter a name for the channel.

Channel names are reflected - and can be changed - in all areas; the Track List, the Main Mixer and in the device. Mix Channel source devices and tracks have independent names from the Mix Channel device/channel strip. By default, a Mix channel takes its name from its source device (typically, the instrument device connected to it). If you change the name of the source device, the Mix channel name will change too.

If you want the source device and Mix channel to have different names, change the name of the Mix channel. To return to the default state (and use the source device name for the Mix channel), just delete the Mix channel name.

! **There are special naming conventions when you are using Parallel Channels, see “Naming Parallel Channels”.**

## Coloring mixer channels

Mixer channels are shown with the same color as their corresponding rack devices and tracks. The color is shown in the channel header and channel strip section headings:



*A channel strip with all sections folded, except for the Fader section.*

- **You can change the color for a channel by selecting it and using the Channel Color submenu on the Edit menu or context menu. This will also change the color of the corresponding rack device and track (and vice versa).**
  - **For Mix Channels connected to a source device (e.g. an instrument), the Channel Color submenu has a special setting called "Mirror Source Track Color". If this is on, any color settings you make will be reflected both in the source device (the instrument device and track) and in the channel strip.**  
This is true regardless of whether you change the color in the mixer, in the rack or in the sequencer.
  - **To make independent color settings for Mix Channels, turn off "Mirror Source Track Color" first.**  
For example, this is useful if you have a Redrum with separate outputs connected to different Mix Channels, and want these to have different colors in the mixer.
- ! **If you change the color of an Output Bus channel, this will be reflected in the Output areas on all other channels connected to that Output Bus, see “Creating an Output Bus”.**

# The channel strip

The channel strip is divided into sections, each marked with a section header. Mix Channel and Audio Track channel strips have identical parameters. Here is a detailed rundown of the parameters and functions in each section.

## Input section



### Input Gain

Parameter	Description
Gain	This sets the input gain for the channel. Range is +/- 18 dB. If Gain is set to any other value than the default 0,0 dB or Invert Phase is on (see below), a LED is lit to the right in the section header to indicate the section is active.
INV (Invert Phase)	This inverts the phase of the input signal to correct eventual phase problems. For example, using multiple microphones during recording can sometimes cause phase-cancellation between microphones picking up the same sound source but at slightly different distances. Phase problems are most noticeable when signals are summed to mono. Out of phase signals are indicated by a lack of lower frequencies and a generally "hollow" sound quality.

### Signal Path section

The Dynamics, EQ and Insert effect sections will by default process a channel signal in that order, i.e. the order of the sections as shown in the channel strip (from the top down). By using the buttons in this section, the signal path order can be changed internally.

Parameter	Description
Insert Pre	If this button is activated, the Insert effects are placed before the Dynamics and EQ sections in the signal path.
Dyn Post EQ	Activating this button places the EQ before the Dynamics and Insert sections in the signal path.
Insert Pre + Dyn Post EQ	If both buttons are activated, the order will be Insert, EQ and lastly Dynamics.
FILTERS TO DYN S/C	See <a href="#">"About the Filters To Dynamics Sidechain button"</a> .

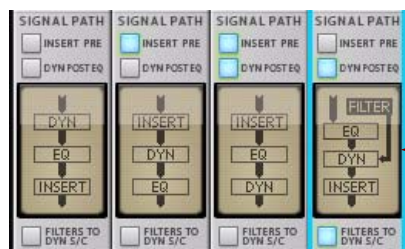

*The displays illustrate the selected signal path order of the processing for each channel.*

# Dynamics section



Each channel strip has a powerful dynamics section featuring compression/limiting and gating/expansion. The upper part of the section (with a white background) is the compressor/limiter, and the lower part (gray background) is the gate/expander. The compressor and gate processing can be independently switched in or out of the circuit.

## Compressor/Limiter

Compressors reduce dynamic range by evening out the difference between loud and quiet signals. This makes signal levels easier to balance, and can add punch and sustain to the sound.

The Main Mixer's compressor/limiter is a flexible processor which has soft-knee (a gradual, smooth onset of compression) characteristics but can be switched to peak limiting, where levels above the set threshold are instantly reduced. The compressor also features automatic make-up gain.

The parameters are as follows:

Parameter	Description
Comp "ON" button	Activates/deactivates the compressor.
RATIO	Sets the amount of gain reduction applied to the signal above the set Threshold. The Ratio can be set from 1:1 (no reduction) to Infinite:1.
PEAK button	When activated this changes the signal detection from RMS to Peak, which results in an instant attack time. Peak mode is suitable for compression of sounds with fast attacks like drums.
THRES (Threshold)	This sets the level at which onset of compression occurs. Signals below the Threshold setting are unaffected, but when the level exceeds the threshold, compression kicks in. Range: -52 dB to 0 dB Automatic make-up gain (based on the Ratio and Threshold settings) is applied to compensate for level reduction caused by compression and maintain a steady output level.
REL (Release)	Release determines the time it takes before the compressor lets the sound through unaffected after the signal level drops below the set threshold. Set this to short values for "pumping" compressor effects, or to longer values for a smoother change of the dynamics. Range: 100ms to 1000ms.
FAST button	Attack - the time it takes for the compressor to react when signals rise above the set threshold level. If the FAST button is activated the attack will be fixed at 3ms for 20 dB gain reduction.
Meter	The right LED meter shows the gain reduction applied by the compressor.

## Gate/Expander

Gating or expansion will attenuate signals below a set threshold; the opposite of compression. It can be used to reduce or eliminate unwanted background noise that may be present when there is no signal to mask it. Gating is also commonly used to reduce microphone “bleeding”, e.g. when recording a close-mic’ed drum kit you can use gating to silence the tom microphones when the toms aren’t being played to tighten up the sound, and for special effects like “keying” (see below).

Higher expansion ratios (10:1 and above) are referred to as noise gating, where the channel is completely silenced if the level drops below the set threshold.

The Gate/expander has the following parameters:

Parameter	Description
Gate “ON” button	Activates/deactivates the gate.
RANGE	Sets the amount of gain reduction applied to signals below the set Threshold. The Range can be set from 0dB (no reduction) to -40dB. If the EXP button is on (see below), the RANGE knob sets the expansion amount.
EXP button	When activated this changes the operating mode from Gate to Expansion. The RANGE knob (see above) then sets the expansion amount.
THRES (Threshold)	This sets the level at which the gate opens or closes. Signals below the Threshold setting are gated, but when the level exceeds the threshold, the gate opens. Range: -52 dB to 0 dB Note that the threshold for closing the gate is slightly lower than the threshold for opening the gate. This is to avoid undesirable gate triggering with signal levels close to the set threshold.
REL (Release)	Release determines the time it takes for the gate to go from open to fully closed. Fast release times will fade the signal abruptly once the level falls below the threshold, and longer release times will slowly fade out the signal. Range: 100ms to 1000ms.
FAST button	Attack - the time it takes for the gate to open - is normally 1.5ms per 40dB. If the FAST button is activated the attack will be 100µs (microseconds) per 40 dB, which is useful for percussive material where the waveform rises steeply in a very short time.
HOLD	This determines the time the gate stays fully open after the signal falls below the threshold. Hold interacts with the Release parameter such that Release only starts acting after the set Hold time. Range: 0ms to 4000ms.
Meter	The left LED meter shows the gain reduction applied by the gating/expansion.

## About the Filters To Dynamics Sidechain button



When this button (found in both the Input and EQ sections) is activated, the Low Pass and High Pass filters can be used to filter the channel sidechain signal before the dynamic processing.

The channel signal itself will not be directly affected by the filters, only the sidechain signal. The filtered sidechain signal is what triggers the dynamic processing, but the dynamic processing is applied to the channel signal. This allows you to use frequency sensitive compression.

By trimming low and/or high frequencies you can specify which frequency range should trigger the compressor or gate. A typical application of frequency sensitive compression is “de-essing” where harsh sibilants in vocal material are reduced or eliminated. This is done by filtering the Sidechain signal so that only high frequencies (“s” noises) will trigger the compressor.

**! When the “Filters To Dyn S/C” is active, the LPF and HPF buttons are not available in the Spectrum EQ Window, see “The Spectrum EQ Window”.**

## The Key button and the Dynamics Sidechain inputs

You can use external signals to trigger the Dynamics section. This is done by connecting an external signal output to the Sidechain inputs on the back of the Mix Channel or Audio Track rack device.



*The Sidechain inputs.*

When a cable is connected to the Sidechain inputs the “KEY” button is activated automatically and the Dynamics section for the channel will now be “keyed” i.e. triggered by the external signal instead of the channel signal.

For example, you could use a drum loop to trigger the gate for a channel playing a synth pad to create rhythmic chord effects.

See [“Using compression sidechaining”](#) for a description of further uses of sidechaining.

## About Gain Reduction CV



The Gain Reduction CV out connector on the back of a Mix Channel or Audio Track rack device can be used to modulate other parameters with the amount of gain reduction applied by the compressor/gate. The gain reduction CV out can be used as an envelope follower as the CV follows the dynamics of the original signal.

For example, try using gain reduction CV to control filter frequency for “auto-wah” effects.



## EQ section



This is a four-band EQ with parametric midrange controls and high and low frequency shelving bands. The EQ can be switched between two operating modes, each with slightly different curve characteristics. There is also a filter section with low pass and high pass filters.

The EQ can be placed before or after Dynamics in the signal path - see [“Signal Path section”](#).

The parameters are as follows:

Parameter	Description
Spectrum EQ Window button	Click this button to bring up the Spectrum EQ Window where you can edit the EQ and Filter parameters graphically, see <a href="#">“The Spectrum EQ Window”</a> .
LPF “ON” button	Activates/deactivates the low pass filter. A low pass filter lets low frequencies pass and cuts out the high frequencies.
HPF “ON” button	Activates/deactivates the high pass filter. A highpass filter is the opposite of a lowpass filter, cutting out lower frequencies and letting high frequencies pass.
LPF Frequency	The Low Pass filter (LPF) removes high frequencies from the signal, making the sound less bright. The LP filter has 12dB/Octave roll-off curve. Range is 100 Hz - 20 kHz.
HPF Frequency	The High Pass filter (HPF) removes low frequencies from the signal, causing a thinner sound. The HP filter slope has a 18 dB/Octave roll-off. Range is 20 kHz - 4 kHz.
FILTERS TO DYN S/C button	See <a href="#">“About the Filters To Dynamics Sidechain button”</a> .
EQ “ON” button	Activates/deactivates the EQ. (This does not affect the LPF/HPF filters.)
“E” button	When the “E” button is activated the EQ will have slightly different curve characteristics. In normal mode (E button deactivated), the Gain setting will also affect the bandwidth (Q) for the HMF and LMF EQ sections. The higher the gain, the narrower the bandwidth and vice versa. With E mode activated, bandwidth is constant at all gain settings. (Check out the difference in <a href="#">“The Spectrum EQ Window”</a> if you like.)

Parameter	Description
HF Gain/Frequency	The HF section provides high frequency shelving equalization. Frequencies above the set corner Frequency will be cut or boosted by the set HF Gain amount. The HF Gain control can cut or boost the selected frequency range +/- 20dB and the HF Frequency can be set between 1.5kHz - 22kHz.
HF BELL mode	When this button is activated, the HF EQ will switch to peaking characteristics. This means it works like a regular parametric EQ band, cutting or boosting the signal around the set frequency. Bell mode has a fixed bandwidth or "Q" (see below).
HMF Gain/Frequency/Q	The high medium frequency EQ is fully parametric. HMF Gain is adjustable +/- 20dB. Center frequency range is 600 Hz - 7 kHz. The "Q" parameter adjusts the bandwidth around the set center frequency. Q range is 0.70 - 2.50. The higher the Q value, the narrower the affected frequency range - except in "E" mode (see above).
LMF Gain/Frequency/Q	The low medium frequency EQ is also fully parametric. LMF Gain is adjustable +/- 20dB. Center frequency range is 200 Hz - 2 kHz. The "Q" parameter adjusts the bandwidth around the set center frequency. Q range is 0.70 - 2.50. The higher the Q value, the narrower the affected frequency range - except in "E" mode (see above).
LF Gain/Frequency	The LF section provides low frequency shelving equalization. All frequencies below the set Frequency will be cut or boosted by the set LF Gain amount. The LF Gain control can cut or boost the selected frequency range +/- 20dB and the LF Frequency can be set between 40 Hz - 600 Hz.
LF BELL mode	This works in the same way as described above for the HF filter, but affects the LF filter.

## The Spectrum EQ Window

The EQ section can also be displayed and edited "visually". This is done in the Spectrum EQ floating window. Besides the EQ functionality, the Spectrum EQ also features a spectrum analyzer which displays the audio frequency content of the selected mixer channel in real-time. Here is how you can work with the Spectrum EQ:

1. **Select "Show Spectrum EQ Window" from the Window menu (or press [F2]), or click the Spectrum EQ Window button on the desired channel strip (see "Spectrum EQ Window button") or on the device in the rack:**

The Spectrum EQ window shows up and the (pre-Fader) frequency content of the currently selected mixer channel is displayed in gray during playback:



*The Spectrum EQ Window with audio playing back.*

- ! **The LPF and HPF buttons are only present when the "FILTERS TO DYN S/C" button is off.**
- **Click and drag the Spectrum EQ window frame to resize the window horizontally and vertically as desired.**
- **Select the desired mixer channel for the Spectrum EQ by selecting it from the drop-down list at the bottom of the window.**

- ! If “Master Section” is selected, no controls are available in the window, since the Master Section lacks these.
- If the “Follow Selection” checkbox is ticked, changing sequencer track, Mix Channel/Audio Track device in the rack, channel strip, or editing parameters on other channel strips will automatically change the Spectrum EQ Window focus to show the signal of the corresponding mixer channel.

2. Tick the “EQ On” box to activate the EQ in the channel strip and bring up the parameters in the window.

You can also activate the HPF and LPF Filters, E Mode, HF Bell mode and LF Bell mode for the selected mixer channel by ticking the corresponding checkboxes in the window. The pictures below shows how the different objects in the Spectrum EQ window correspond to the channel strip parameters:



The Spectrum EQ Window with the Filters, EQ, E Mode, Bell Mode and Analyzer functions active during audio playback.



The Spectrum EQ editing objects (points) and what parameter(s) they affect in the mixer channel strip.

- **Click and drag any of the points in the window to change the frequency (and gain for the EQ points) value(s).**  
Dragging sideways changes the frequency value and dragging vertically changes the gain (of the EQ points). As you edit the points, the corresponding channel strip parameter(s) are updated in real-time - and vice versa. The white line in the window shows the resulting EQ (and Filter, if activated) curve.
- **Hold down [Shift] and drag to constrain the movement to vertical and/or horizontal.**  
This allows you to change either frequency or gain without affecting the other.
- **[Ctrl]-click (Win) or [Cmd]-click (Mac) on an EQ point to reset its Gain value to 0dB.**
- **When you hover over a point, its current values are displayed numerically in the Frequency, Gain and Q fields below the graph. The parameter's (or section's) name is also displayed at the bottom left in the window:**  
(The point remains selected until you touch another point with the mouse or click on the window background.)



*The HMF EQ point is selected and highlighted in the window.*

- ! **Note that the Analyzer always shows the audio frequencies before the Fader section. This means that any Filter and/or EQ changes you make will affect the displayed frequency content. Also, if you use any Insert FX, these could also affect the frequency content.**
- **Hold down [Alt](Win)/[Option](Mac) and drag an EQ point vertically to change its Q-value.**  
This is only valid for the HMF and LMF EQ points, since these are the only ones that have a Q parameter.
- **It is possible to record parameter automation in the sequencer by dragging the points around in the Spectrum EQ Window during recording. Just make sure you have created a sequencer track for the channel you want to automate. See “Parameter automation recording procedure” for more details.**

## Insert FX section



The channel strip Insert FX section allows you to load an Effect Combi patch, which can in turn contain any number of effects and other devices. Insert effect devices that belong to the patch are added to the Audio Track or Mix Channel device in the rack.

The main parts of this section are the assignable Rotary knobs and buttons. Combinator Effect patches in the Factory Sound Bank will have various parameters and switches assigned to these controls, and the labels will have names describing the parameter/function.

Insert effects process the whole channel signal, as opposed to Send effects where the effect balance is adjustable. Typical examples of when to use insert effects include compression, distortion and modulation effects such as chorus.

The Insert effects can be placed ahead of the Dynamics and EQ sections in the signal path - see ["Signal Path section"](#).

- **Loading Insert FX patches is done using the patch browser located at the bottom of the Insert FX section.**  
Insert effects patches in Combinator format can be loaded.
- **See ["Insert FX"](#) for descriptions of how to work with Insert effects.**
- **Assigning parameters to the Rotary controls and buttons is done in the Programmer section of the rack device.**
- **Creating your own Insert FX patches is done in the Combinator.**

The Insert FX section in the channel strip contains the following parameters:

Parameter	Description
Bypass	Bypasses the Insert effect(s).
Rotary knobs 1-4/ Buttons 1-4	The four rotary controls and buttons are programmable and provide control over selected parameters and functions in an effect Combi patch. Assigning parameters to the controls is done in the Programmer for the Audio Track or Mix Channel device - see <a href="#">"Insert FX"</a> .
Patch browser	This is a standard patch browser for channel Insert FX where you can select/save patches in the Combinator Effect patch format.
Edit Inserts	This will bring the channel's rack device into view with its Insert FX container opened, allowing you to edit the effect devices.

## FX Sends section



Send effects, which are global for all channels in the Main Mixer, are connected to the Master Section rack device. Up to 8 Send effects can be used simultaneously. For a description of how to use Send effects, see [“Send FX”](#).

The FX Sends section contains the following parameters:

Parameter	Description
FX Send On 1-8	Activates the Send for the channel.
Level 1-8	The Send Level knobs control the amount of channel signal that is to be sent to the effect connected to the corresponding Send.
PRE button	Send channel output is normally taken post channel fader, so that changing the channel's volume also changes the send level. By activating the PRE button, the send output is taken pre channel fader. In this mode, the send level is independent of the channel fader.

## Fader section



The Fader section is used for controlling the level of the channel and its stereo placement in the mix. The section has the following parameters:

Parameter	Description
Pan L/R	Use this control to set the left/right position of the channel in the stereo field. [Ctrl]-click (Win) or [Cmd]-click (Mac) the Pan knob to reset to the default "0" (center position).
Width	Width will only be available on stereo channels. It allows you to control the width of the stereo field for the channel. Normally this is fully on (value 127) which represents full stereo. By decreasing this value the stereo width is narrowed. Turned fully off the channel output will be in mono.
MUTE/SOLO buttons	<p><b>! Note that the Mute and Solo functions in the Main Mixer are NOT the same as Mute and Solo of sequencer tracks (see "Muting tracks" and "Soloing tracks").</b></p> <p>Clicking a channel's Mute button silences the output of that channel. Click the button again to unmute the channel.</p> <p>Clicking a channel's Solo button silences all other mixer channels, so that you only hear the soloed channel. Several channels can be soloed at the same time, but if this is the case, note that soloed channels can't be muted with the Mute button. To mute one of several channels in solo mode you simply "un-solo" it. There are also Mute All Off/Solo All Off buttons in the Master Section - see "Master Section Header".</p> <p>If you are using Output Busses (see "Output Busses") and/or Parallel Channels (see "Parallel Channels"), the Solo and Mute functions affect the other concerned channels in an intelligent way, see "Solo, Mute and Send FX logic".</p>
Channel Fader	<p>The channel fader is used to control the output level of each channel.</p> <p>By adjusting the faders, you can set the desired mix (balance) between channels.</p> <p>If a channel is an Output Bus (see "Output Busses"), the Fader section background is colored and the Fader knob is red.</p>
Channel Meter	The meter is a graphical representation of the channel output level. Stereo channels have two level bars and mono channels have one. If the signal level pushes the meter into the red, to avoid distortion try lowering either the output level of the device connected to the channel device or the channel fader itself. The meter is a VU meter, taking into account any VU offset set in the Big Meter of the Reason Hardware Device - see "The Big Meter".
Output Bus Selector	Here you can route the channel to an Output Bus (sub-mixer) instead of to the default Master Section, see "Output Busses".

## About Level/Pan CV

On the back of the Programmer section of a Mix Channel or Audio Track device you will find CV inputs for the channel Level and Pan controls. These allow for automatic level and pan control from sources that output CV signals.

→ Press [Tab] to flip the Rack around, then click the "Show Programmer" button to access the CV jacks.

## Channel Header section

The Channel Header is always visible at the bottom of the channel strip. It contains the following items:

The Edit Focus indicator - When you select a channel, the horizontal strip at the top of the Channel Header lights up red to indicate Edit Focus. The channel most recently clicked will have edit focus, regardless of how many channels are selected. When using [Ctrl](Win)-click or [Cmd](Mac)-click to deselect previously selected channels, edit focus will be on the most recently deselected channel.

Edit Focus also reflects the last selected track or Mix device, which is useful when moving between work areas because the channel with Edit Focus will always be in view in the Main Mixer. For example, if you select an ID8 track in the sequencer, the Mix channel to which it is connected will be scrolled into view in the Mixer, and will be given Edit Focus.

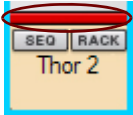

*The top strip is lit to indicate Edit Focus.*

- **When you are using the Spectrum EQ Window, and the “Follow Selection” box is ticked, the channel with Edit Focus is displayed in the window, see “[The Spectrum EQ Window](#)”.**

The Remote Base Channel indicator - To the left in the same horizontal strip area a small yellow arrow symbol can be shown. This is the Remote Base Channel indicator, which shows which channel is considered the first or base channel when using Remote Control - see “[Setting the Remote Base Channel](#)”.



*The Remote Base indicator.*

The RACK and SEQ buttons allow you to switch to a channel's rack device or sequencer track directly from the mixer - see “[Switching between channels, rack devices and tracks](#)”.

The Channel Header area reflects the selected Track Color (see “[Coloring mixer channels](#)”).

You can rename the channel by double-clicking on the name (see “[Naming mixer channels](#)”).

Note that the Channel Header is a little shorter if the channel is a Parallel Channel (see “[Parallel Channels](#)”).



# The Master Section strip

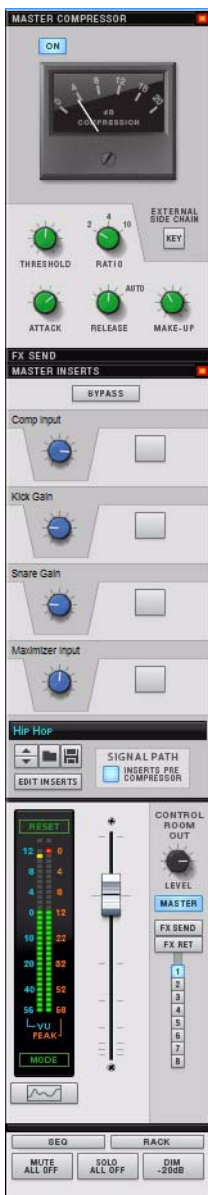

The Master Section is where all your audio track and mix channels are mixed down to the Master Out bus. The Master Section strip contains a bus compressor and Insert FX section, both of which process the master bus, as well as send/return master level and pan controls for the eight FX Sends. Any processing applied to the master bus affects all channels that are routed to the Master Section.

## Master Compressor section



The Master Compressor is perfect for providing the final “fairy dust” to your mix. It can add punch and cohesion, and generally make the mix sound bigger and more powerful. The compressor is very straightforward in operation and features make-up gain as well as program-adaptive Release.

The Master Compressor can be applied pre or post Master Insert section - see [“Master Inserts section”](#).

The parameters are as follows:

Parameter	Description	Range
On button	Activates/deactivates the Master Compressor.	
Meter	The meter shows the amount of gain reduction in dB.	0dB - 20dB
Threshold	This sets the level at which onset of compression occurs. The lower the Threshold, the more compression will be applied.	-30dB to 0dB
Ratio	Ratio specifies the amount of gain reduction applied to signal levels above the set threshold. A 2:1 compression ratio effectively means that a signal level 2dB above threshold will have a signal gain of 1dB.	Fixed Ratios: 2:1 / 4:1 / 10:1
Attack	This governs how quickly the Master Compressor will react when signals rise above the set threshold.	Fixed settings (in ms): 0.1 / 0.3 / 1 / 3 / 10 / 30
Release	When the signal level drops below the set threshold, this determines how long it takes before the compressor lets the sound through unaffected. If set to “Auto”, the Release time will be program adaptive, so the Release time is automatically increased following long peaks and decreased following short peaks.	Fixed settings (in s): 0.1 / 0.3 / 0.6 / 1.2 /Auto
Make-Up	Make-Up gain compensates for level reduction caused by compression and helps maintain a steady output level.	-5dB to 15dB
KEY button/External Side Chain	When a cable is connected to the Sidechain inputs on the back of the Master Section device, the KEY button is activated automatically and the Master Compressor will now be triggered by the external signal instead of the master bus signal. When a sidechain source is connected you can turn the KEY button off to monitor the side-chain signal. See <a href="#">“Using compression sidechaining”</a> for a description of how sidechaining can be used.	

## FX Send section



This section controls the master levels of the FX Sends. Send effect devices are connected to the Master Section via the eight FX Send and eight FX Return connectors on the back of the rack device.

See [“Send FX”](#) for a description of how to set up an use Send FX.

The Send bus can be monitored via the Control Room output - see [“Control Room output section”](#).

The section contains the following items:

Parameter	Description
Level 1 - 8	Adjusts the FX Send master level. The master send levels are normally left at default 0dB. if you wish to increase/decrease the effect balance, this is best done by increasing/decreasing the send levels for the individual channels using the effect.
Meter	Shows the signal level of the send bus.
EDIT button	This brings the connected effect device in the rack into view for easy editing of its parameters.
Name label	This automatically shows the name of the connected effect device. If you enter a new name for the label, this overrides the automatic naming. Deleting a manually entered name will bring back the automatic naming.

## Master Inserts section



The Master Inserts Section is identical to the Insert FX section in the channel strips, except that it affects the master bus, i.e. the whole mix. You can load Combinator effect patches, which can include anything from a single device to a complex array of multiple devices, to process the master bus.

The Master Insert slot is ideally used to apply mastering effects for finalizing the mix.

Devices that belong to the Insert effect patch are added to the Master Section device in the rack.

The main parts of this section are the assignable rotary knobs and buttons. Combinator Effect patches in the Factory Sound Bank will have various parameters and switches assigned to these controls, and each label will have a name describing the assigned parameter/function.

The Master Insert effects can be placed ahead of the Master Compressor in the signal path. By default, the Master Insert effects are placed after the Master Compressor in the signal path. This makes sense, as you usually add a Maximizer or Mastering Combi patch as a Master Insert effect, and this must be last in the signal path to avoid clipping on the output. However, if necessary, you can place the Master Insert effects before the Master Compressor, by activating the "Inserts Pre Compressor" button.

→ **Loading Insert FX patches is done using the patch browser located at the bottom of the Insert FX section.**

Insert effects in Combinator format can be loaded.

• **See "Insert FX" for descriptions of how to work with Insert effects.**

The Inserts section in the Master Section contains the following parameters:

Parameter	Description
Bypass	Bypasses the loaded Insert effect(s).
Rotary knobs 1-4/ Buttons 1-4	The four rotary controls and buttons are programmable and provide control over selected parameters and functions in an effect patch. Assigning parameters to the controls is done in the Programmer for the Master Section rack device - see "Insert FX".
Patch browser	This is a standard patch browser for Master Insert FX where you can select/save patches in the Combinator Effect patch format.

Parameter	Description
Edit Inserts	This will bring the Master Section device into view in the rack, with its Insert FX container opened, allowing you to edit the effect devices.
Signal Path button	If activated, the "Inserts Pre Compressor" button will place the Inserts before the Master Compressor in the signal chain. If the Master Insert effects contain a maximizer or limiter, the inserts should normally be last (this button should be left in the off position).

## FX Return section



This section controls the master levels of the FX Returns. Send effect devices are connected to the Master Section via the eight FX Send and eight FX Return connectors on the Master Section device. See ["Send FX"](#) for a description of Send FX.



*Send/Return connectors on the Master Section device.*

You can monitor the Return bus via the Control Room output - see ["Control Room output section"](#).

The section contains the following items:

Parameter	Description
Level	Adjusts the FX Return master level. The master return levels are normally left at the default value, 0dB. If you wish to increase/decrease the effect balance, this is best done by increasing/decreasing the send levels for the individual channels using the effect. You can, however, use the FX Return level to change the overall balance of a send effect in the mix.
Pan	Pan adjusts the return signal stereo balance.
Meter	Shows the signal level of the return bus.
EDIT button	This brings the connected effect device in the rack into view for easy editing of its parameters.
Mute (M)	This mutes the return signal for the send effect.
Name label	This automatically shows the name of the last effect device in the send signal path. If you enter a new name for the label, this overrides the automatic naming. Deleting a manually entered name will bring back the automatic naming.

## Master Fader section



The Master Fader controls the final output level of the mix to be recorded or exported to a file. It should normally be set to 0dB. The Master Fader should never be used to adjust the monitoring level - this is what the Control Room bus is for (see below).

The section contains the following items:

Parameter	Description
Master Fader	Adjusts the level of the Master Out bus.
Meter	Shows the level of the Master Out bus.
Mode	The Mode button switches the meter between VU/Peak/PPM modes - see <a href="#">"The Big Meter"</a> .
Reset	This resets the meter, deleting any registered peaks.

## Spectrum EQ (Spectrum Analyzer) Window button



Below the Meter is a button for bringing up the Spectrum EQ Window. Since there are no Filter or EQ sections in the Master Section, the Spectrum EQ Window is used only for displaying the frequency content of the Master Section.

## Control Room output section

The Control Room outputs are located on the back of the Master Section device. To use the Control Room output section, the outputs have to be connected to your monitor system. This can be done by manually patching cables from the "Ctrl Room Out" connectors to a separate output pair on the Reason Hardware Device - see ["Manual audio routing"](#).



The Control Room outputs, which are separate from the Master Out bus, are the outputs that you should monitor (listen) from. This allows you to monitor the main mix and to adjust your monitoring level without affecting the Master Out bus. You can also monitor the FX Send or Return buses in this section.

The section contains the following items:

Parameter	Description
Control Room Out Level	Adjusts the level of the Control Room bus. This parameter is what you use to change the overall monitor level.
Master/FX Send/FX Return buttons	These buttons allow you to switch monitoring between the Master bus, the Send bus and the Return bus.
Control Room FX Select buttons	When monitoring Send/Return busses, you use these buttons to set which Send/Return bus to monitor. One bus can be monitored at a time.

## Master Section Header



The Header is always visible at the bottom of the Master Section. It contains the following items:

Parameter	Description
SEQ / RACK buttons	The RACK and SEQ buttons allow you to switch to the Master Section rack device or automation track directly from the mixer - see " <a href="#">Switching between channels, rack devices and tracks</a> ".
Mute/Solo All Off	This allows you to switch off all channel Mute or Solo buttons in one go.
DIM -20dB	This simply dims the Master Out level -20dB. Use this to temporarily lower the output level when answering the phone, etc.

## Automating mixer parameters

Automating mixer parameters works in the same way as for other parameters. Automation is part of the audio track or Mix channel track. See "[Recording parameter automation](#)".

- **A quick way to automate a parameter is to right-click (Win) or [Ctrl]-click (Mac) on the parameter and select "Edit Automation" from the context menu.**  
This will create an automation lane (and track if needed) where you can record or draw automation.
- **When you select a sequencer track, the "Record Enable Parameter Automation" button is automatically enabled, allowing for parameter automation to be recorded. However, when recording automation for Audio Track channel strip parameters, you may want to disable the regular Record Enable button to avoid recording audio by mistake.**

## Working with effects

### Insert FX

By definition, insert effects are inserted in the signal chain and process the whole channel signal, as opposed to Send effects (see "[Send FX](#)") where the effect balance is adjustable. Typical insert effects are dynamics, distortion, chorus etc., plus mastering effects for the Master Section.

As mentioned earlier in this chapter, the channel strips and Master Section strip have a "slot" dedicated to insert effects - the Insert FX section. In the Insert FX section, you can choose to load Effect Combi patches using the standard Patch browser. However, it's also possible to manually create effect devices and use as insert effects.

- **A very flexible way of using Insert FX is to have the effects in separate mixer channels and utilize parallel processing, see "[Parallel Channels](#)".**

## Adding Insert effects

To add an effect device as an insert effect, proceed as follows:

1. **Select a channel strip in the Main Mixer, a Mix Channel or Audio Track device in the rack, or an audio track or Mix Channel track in the sequencer.**
2. **Select the desired effect device from the Create menu or from the context menu.**  
The effect device is created and automatically routed in the Insert FX container in the channel's rack device.



A Line 6 Guitar Amp device created as Insert FX in an Audio Track device.

3. **If you need to re-route any connections, press [Tab] to flip the rack around.**



The "To Device" and "From Device" connections in the Insert FX slot in the Audio Track device.

- ! **Note that the Mix Channel/Audio Track device must be unfolded to show the connections.**
- **If desired, re-route the connections according to the standard routing procedures (see "Manual routing").**  
The signals always travel from the "To Devices" outputs, via the desired effect devices, to the "From Devices" inputs on the Mix Channel/Audio Track device.
- **When the Show Insert FX button is on, you can add devices directly in the insert FX container area, drag devices in or out, etc. - just like with a Combinator (see "The Combinator").**
- ! **Note that if you add, load or route insert effects in stereo, and the Mix Channel/Audio Track device (and channel strip) is in mono, the channel will automatically switch to stereo.**

## Loading Effect Combi patches

It's possible to load Effect Combi patches directly into the Insert FX container of the channel. An Effect Combi patch loaded in the Insert FX container has the same functionality as a regular Combinator patch, with the following exceptions:

- **Insert FX do not receive note and performance controller data (Pitch Bend, Mod Wheel etc.).**
- **If you load a Combinator patch which has a backdrop image, it is not shown in the Insert FX section in the rack.**



To load an Effect Combi patch in the Insert FX section of a channel strip, proceed as follows:

**1. Click on the “Browse Insert FX Patch” button (with the folder icon).**

The Patch browser opens.

**2. Navigate to an Effect Combinator patch and select it.**

Effect Combinator patches can be found in the Effect Patches folder in the Reason Sound Bank.

**3. Click “OK” to load the selected patch in the Insert FX section.**

The Effect Combinator is loaded and patched in the Insert FX container in the channel's rack device, so you can hear the result of the effect immediately. The name of the patch is also shown in the display on the channel strip:



## Editing and saving Insert effects

Insert effects can be edited from their device panels in the Insert FX container in the channel's rack device. You can also assign device parameters to the four buttons and knobs on the Insert FX Programmer panel. These buttons and knobs are mirrored on the Insert FX section of the channel strip.

Most of the Effect Combi patches already have a number of parameters assigned to the four buttons and knobs on the Insert FX Programmer panel. These assigned parameters can be edited at any time from the Insert FX section in the channel strip, and can also be automated on a Mix Channel/Audio Track in the sequencer.

To edit effect device parameters that are not assigned to the four knobs and buttons on the Insert FX Programmer panel, you have to access the device(s) in the rack.

**1. Click the “Edit Inserts” button to get to the channel’s Insert FX container in the rack.**



The channel's Insert FX container is scrolled into view, and unfolded, in the rack.

→ **Now, you can edit the effect device(s) parameters, just like for any other devices in the rack.**

- To edit the parameter assignments on the Insert FX Programmer panel, click the “Show Programmer” button on the Mix Channel/Audio Track device.



The parameter assignments are made in the same way as when creating/editing regular Combinator devices (see “The Combinator”). The parameters you assign to the Insert FX Programmer panel in the rack are automatically mirrored on the four knobs and buttons in the Insert FX section on the channel strip.

2. If you like, you can choose to save your effect device setup in the Insert FX container (along with any parameter assignments) as an Effect Combi patch by clicking the “Save Insert FX Patch” button (with the floppy disc icon) on the Programmer panel.



This will bring up the Patch browser, where you can select name and location for your Effect Combi patch.

- ! You don’t have to save your insert effect as an Effect Combi patch unless you want to use the effect chain in other songs later on. All settings are automatically stored when you save the Song document.

## Bypassing Insert effects

- Click the “Bypass” button at the top of the Insert FX section on the channel strip, or on the device in the rack, to bypass the insert effects for the channel.



The “Bypass” buttons on the channel strip and on the device.

## Deleting Insert effects

Deletion of insert effects can be done either in the rack or with a mixer channel selected in the Main Mixer:

1. Select a Mix Channel or Audio Track device in the rack or a mixer channel in the Main Mixer.
2. Select “Clear Insert FX” from the Edit menu or context menu.  
This will disconnect and delete all Insert FX devices of the selected channel. The deleted devices will be replaced by an internal straight-through connection.

Another way of deleting Insert FX is by manually removing them from the Insert FX container in the Mix Channel or Audio Track device in the rack:

- 1. Unfold the Mix Channel/Audio Track device and click the “Show Insert FX” button.**
- 2. In the Insert FX container, select the device(s) you want to remove.**
- 3. Press [Backspace] or [Delete], or select “Delete Devices and Tracks” from the Edit or context menu.**  
An alert appears asking you to confirm the deletion. (See [“Deleting devices”](#) for more details).

## Copying and Pasting Insert effects between mixer channels

To copy the insert effect(s) from one mixer channel and paste to another mixer channel, proceed as follows:

- 1. Select the mixer channel which contains the Insert effect(s) you want to copy.**
- 2. Select “Copy Channel Settings” from the Edit or context menu and then select “Insert FX” from the sub-menu.**  
If you select the Master Section, the “Copy Insert FX” item will appear directly on the Edit menu or context menu.
- 3. Select the mixer channel to which you want to paste the Insert effects and choose “Paste Channel Settings: Insert FX” from the Edit menu or context menu.**  
If you select the Master Section, the “Paste Insert FX” item will appear directly on the Edit menu or context menu.

# Send FX

Send effects are routed in parallel with the signal chain, and the effect balance can be adjusted - as opposed to Insert effects, which are inserted in the signal chain and process the whole channel signal (see “Insert FX”). Typical Send effects include reverbs and delays.

The Main Mixer can hold up to eight separate Send effects per Song. These eight Send effects can be used simultaneously by any or all mixer channels in the Song, at individually adjustable levels per mixer channel. The main Send FX controls, which include the FX Send and FX Return sub-sections, are located in the Master Section strip in the mixer. In these sections, you can control the FX Send and FX Return levels to and from all mixer channels, as well as panning for each of the Send effects.

In addition to the “global” Send FX controls in the Master Section, each mixer channel features a Send FX section, where you can control the levels to each of the Send effects for the specific mixer channel.

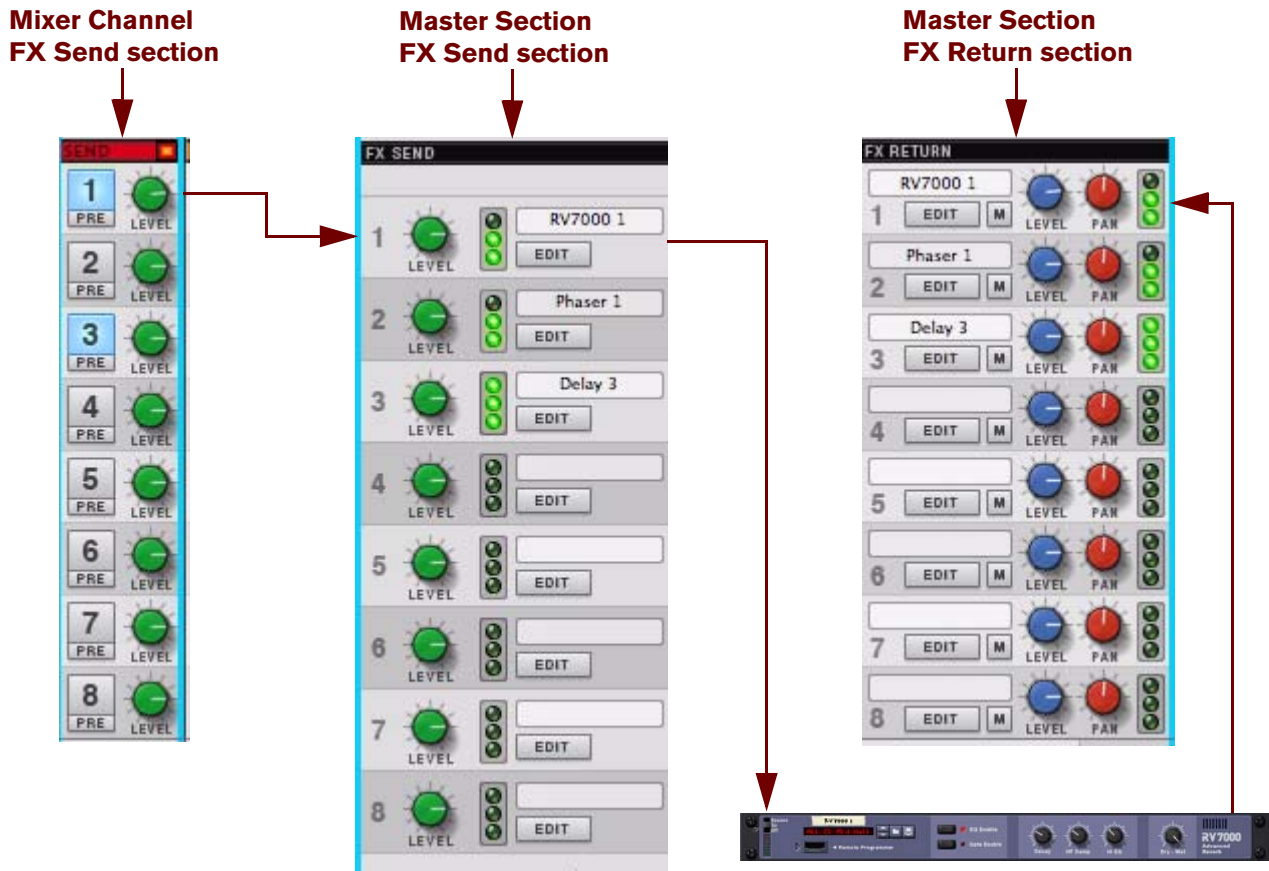

## Creating Send effects

Send effects can be added as follows:

1. In the Main Mixer, select a channel strip or the Master Section strip.
2. Select “Create Send FX...” from the context menu.

The Browser appears (if it was hidden) and the Send FX section gets browse focus. Now, you can now browse for and load effect devices. You can also browse for Effects patches and load these into their corresponding devices, e.g. Effect Combinators.

- ! If all eight Send effect busses are already in use, the “Create Send FX...” item on the context menu is grayed out.

- Each FX Send and FX Return in the Master Section strip has a display that shows the name of the last effect in that send's signal path:

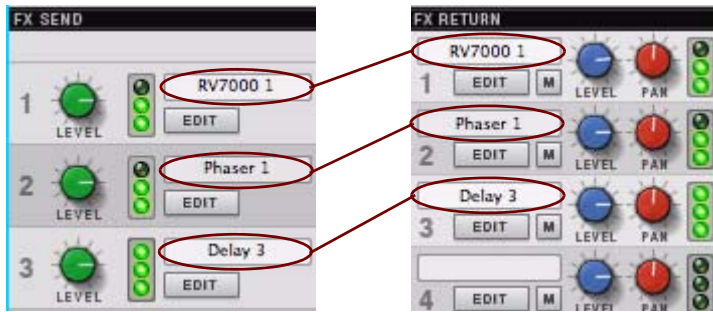

The names of three added Send effects are displayed in the Master Section strip.

3. If you need to re-route any connections, press [Tab] to flip the rack around.

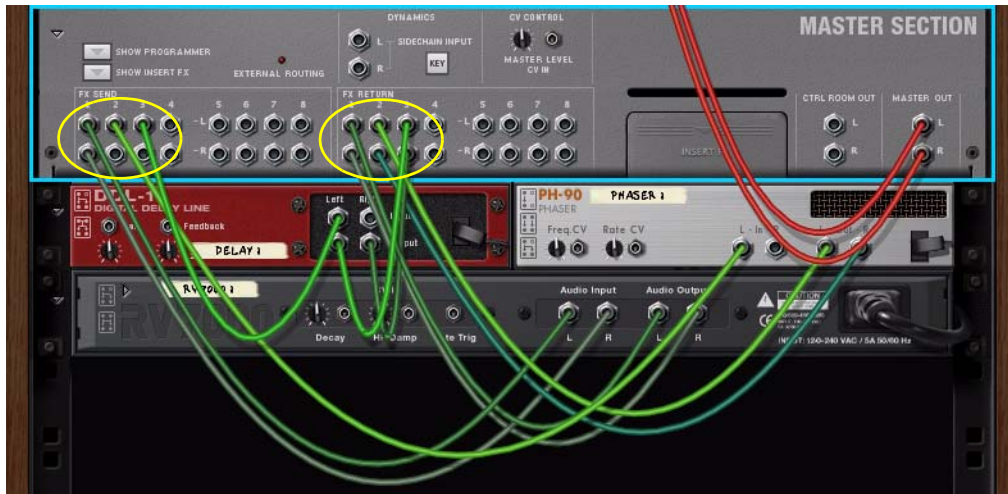

The Send FX connections on the Master Section device.

- ! **Note that the Master Section device must be unfolded to show the connections.**

As you can see, all Send effects are placed outside the Master Section device - as opposed to Insert effects, which are placed in the Insert FX container of the Master Section device.

- **It's also possible to manually connect devices to the FX Send and FX Return connectors according to the standard routing procedures (see "Manual routing").**

The signals always travel from the "FX Send" outputs, via the desired effect device(s), to the "FX Return" inputs on the Master Section device.

## Editing and saving Send effects

- Click the “Edit” buttons in the FX Send or FX Return sections to get to the corresponding Send effect device(s) in the rack.

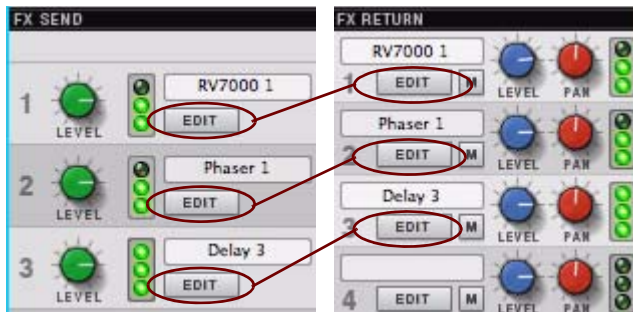

*The Edit buttons for the Send effects in the FX Send and FX Return sections.*

The corresponding Send effect devices are scrolled into view in the rack.

- **Send effects can be edited from their device panels according to standard editing procedures.** Any edits you make will be automatically stored when you save the Song document. If you edit Effect Combi patches, these can also be saved separately as Combinator patches as usual.

## Muting Send effects

- Click one of the “M” buttons in the FX Return section to mute the FX Return for the corresponding Send effect. All channels that currently use the muted send effect will be affected.

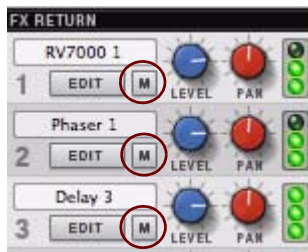

*The Mute buttons for the Send effects in the FX Return section.*

- ! **The Mute buttons only mute the FX Return signals. If you should choose to route an FX Send output of the Master Section device to an effect, and then route the effect to a regular Mix Channel instead of an FX Return input, the Mute button will of course not have any effect.**

## Deleting Send effects

Deletion of Send effects is done in the rack according to the standard device deletion procedures:

- **Select the device(s) you want to delete and press [Backspace] or [Delete] - or select “Delete Devices and Tracks” from the Edit or context menu.** An alert appears asking you to confirm the deletion. (See “Deleting devices” for more details).
- **When a Send effect has been deleted, the name will automatically be removed from the displays in the FX Send and FX Return sections in the Master Section strip.**

# Output Busses

Output Busses allow you to create sub-mixers. Sub-mixers can be very useful for pre-mixing a multi-mic'ed drum kit, or a horn section, for example. You can also use a sub-mixer configuration to route several external input signals (from separate microphones, for example) for recording onto a single audio track (see ["Recording a sub-mix onto an audio track"](#)). You can have as many mix busses as you like in a Reason song.

- For multiple levels of sub-mixing, it's also possible to create an Output Bus that is fed by an existing Output Bus.

## Creating an Output Bus

The fastest and easiest way of creating an Output Bus for several mixer channels is this:

1. Select all mixer channel strips that you want to route to the same Output Bus.
2. Press [Ctrl]+[G](Win) or [Cmd]+[G](Mac) - or select "Route to > New Output Bus" from the Edit menu or context menu of one of the selected channels.

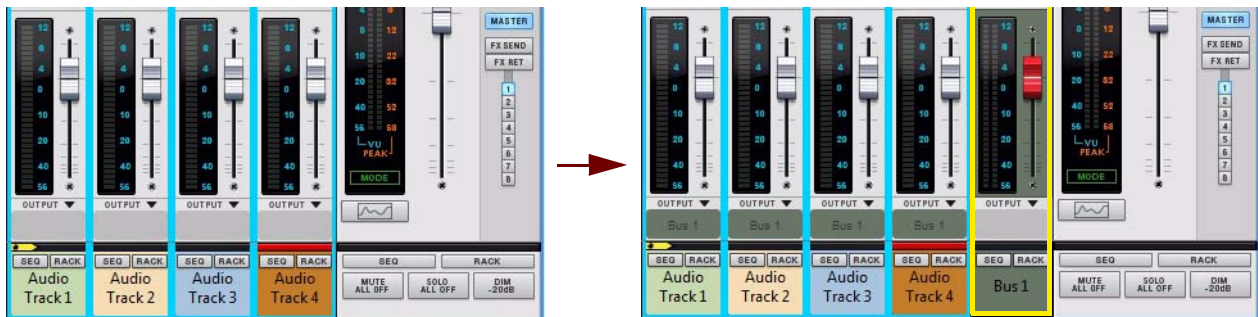

A new Output Bus channel, named "Bus 1", is created to the right and the selected channels are automatically routed to it as indicated on the channels' Output labels.

The step-by-step instructions below show how you can assign individual channels to an Output Bus - one channel at a time. The picture shows a number of Audio Tracks in a song with individual recordings of the drums of a drum kit:



*Audio Tracks with separate drum recordings routed to the Master Section.*

Now, we want to create a sub-mixer which mixes only the individual drum channels. The advantage of doing this is that we can then control the sound and volume of the entire drum kit using only one single Mix Channel:

1. Click the Output selector (the gray name tag) on the Kick channel and select "New Output Bus".

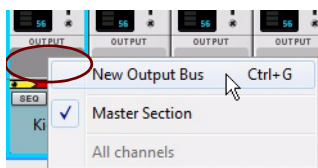

→ **Alternatively, select the Kick channel strip and press [Ctrl]+[G](Win) or [Cmd]+[G](Mac).**

A new Mix Channel is created in the Main Mixer and its corresponding Mix Channel device is created in the Rack. The Kick channel is now routed to the new Mix Channel via the internal P-Lan network.

The Output selector area on the Kick channel is colored and the name “Bus 1” is displayed to indicate the name of the Output Bus it is routed to:



The Fader section of the new Output Bus channel gets a colored background and a red Fader knob to indicate it is an Output Bus.

**2. Click the Output selector on the Snare channel and select “Bus 1”.**



The Output selector area on the Snare channel is now colored in the same color as the Bus 1 channel and the Output Bus name is displayed:

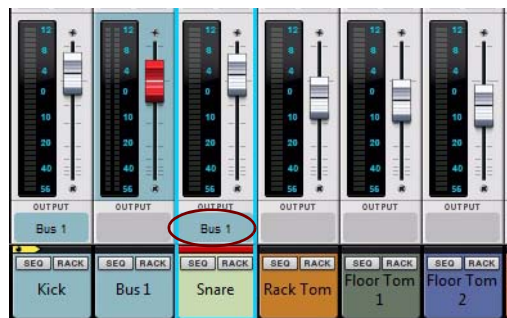

**3. Repeat the procedure for the remaining drum channels in the Main Mixer.**



4. If you like you could now rename the Output Bus channel, e.g. to Drum Mix, and drag the channel strip to the right of the individual drum channels for better overview:



The changed Output Bus name is automatically displayed in the colored Output area on all channels routed to that Output Bus channel.

If you look in the rack, you can see that the Audio Output display on the Audio Track devices for the individual drum channel now show “Drum Mix” instead of the default “Master Section”.

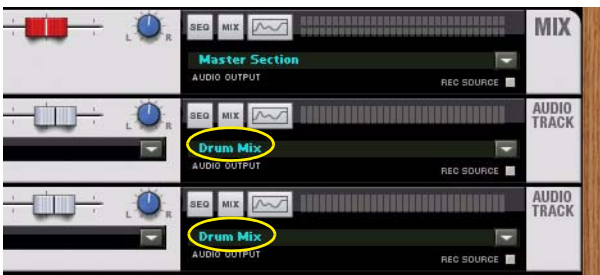

Output Bus destinations on the Audio Track devices in the rack (front and rear).

## Rerouting channels

- If you like you can change the Audio Output destinations - or create new Output Busses - by clicking the Audio Output selector on the device front panel, or in the Audio Output display on the rear panel, or in the Output selector area on the channel strip in the mixer.
- ! If you manually deassign all channels from the Drum Mix Output Bus channel, the Output Bus channel automatically becomes a regular Mix Channel. If you want to assign channels to this Mix Channel, and thus make it become an Output Bus channel again, click the Audio Output selector on the front panel, or in the Audio Output display on the rear panel, and select “All Channels > Drum Mix”. These routings can also be made in the Output selector area on the channel strip in the mixer.

## Deleting an Output Bus

- To delete an Output Bus channel, select the Output Bus channel strip in the Main Mixer - or the device in the rack - and press [Delete] or [Backspace].

When you delete an Output Bus channel which has other mixer channels already routed to it, the source channels will be automatically re-routed to the default Master Section again via P-Lan.

On the Mix Channel/Audio Track devices in the rack, “Master Section” is now shown in the Audio Output displays to indicate that the channels have been re-routed to the Master Section device.

## Recording a sub-mix onto an audio track

The example below shows an Output Bus (sub-mixer) configuration with four microphones connected to one input each on the audio interface and then routed from the Reason Hardware Interface to the Direct Inputs on four Mix Channel devices. The four Mix Channel devices are routed to the “Drums SubMix” Output Bus for sub-mixing:



Direct routing of individual Audio Inputs to Mix Channels which, in turn, are routed to an Output Bus for sub-mixing.

- To record the sub-mixed signals from the “Drums SubMix” Mix Channel onto Audio Track 1, click the Rec Source button on the “Drums SubMix” Mix Channel device, and then select “Stereo Input” and “Drums Sub-Mix” as Audio Input source on the “Audio Track 1” device:

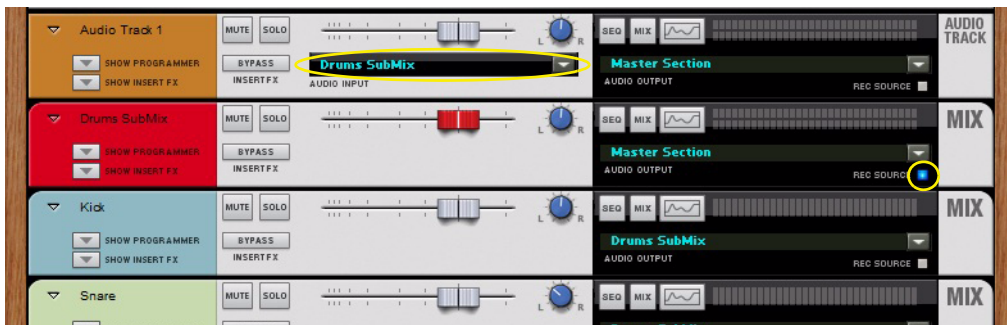

The Rec Source button on the Drums SubMix device activated and “Drums SubMix” selected as Audio Input on the Audio Track 1 device.

See “Recording audio from Mix Channel outputs” for more details.

- In the sub-mixer setups above, each source Mix Channel could also house individual Insert FX. See “Creating an input channel for recording with effects” for tips on how to record with FX.

# Parallel Channels

A very flexible way of working with insert effects is to use parallel channels that host the effects, while keeping the dry signal of the source channel intact. This way you can freely control the levels of the dry signal and the separate effects - and also control the sound of each effect individually from each of the parallel channels.

You could, for example, have one parallel channel with a compressed distortion effect, another parallel channel with a Delay, and so on. Then, you can freely EQ the effects in each of the parallel channels, as well as control their levels individually from each Fader.

## Creating Parallel Channels

Parallel channels can be created as follows:

1. Select the source Mix/Audio Track channel strip in the Main Mixer, or its device in the rack.

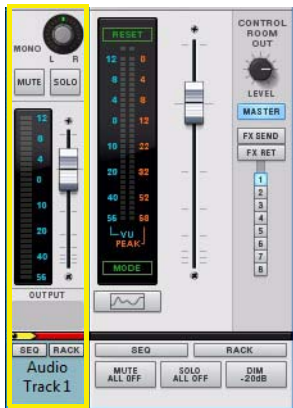

2. Select “Create Parallel Channel” from the Edit menu or context menu.

A new Mix Channel is created and placed to the right of your original channel in the Main Mixer:

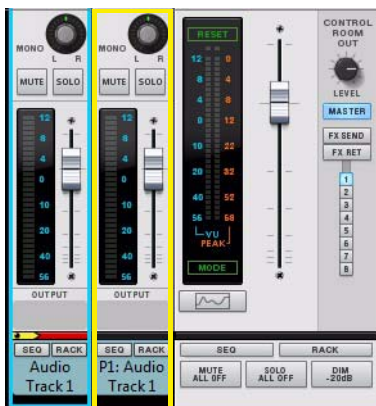

*A Parallel Channel created for Audio Track 1.*

The parallel Mix Channel is automatically named “P1: <source channel name>” and its channel header is colored according to the source mixer channel header. Both the source channel and the parallel channel also get shorter channel headers to indicate they are routed in a parallel configuration.

- If you want to add more parallel channels to your source channel, select the last created parallel channel and select **“Create Parallel Channel”** from the Edit menu or context menu. This adds another parallel channel to your source channel:



Another Parallel Channel created for Audio Track 1.

In the rack, the Parallel out jack(s) of the source Mix Channel/Audio Track device are automatically connected to the Direct Input jack(s) of the first parallel Mix Channel. The second parallel Mix Channel is then connected to the first parallel Mix Channel, and so on:

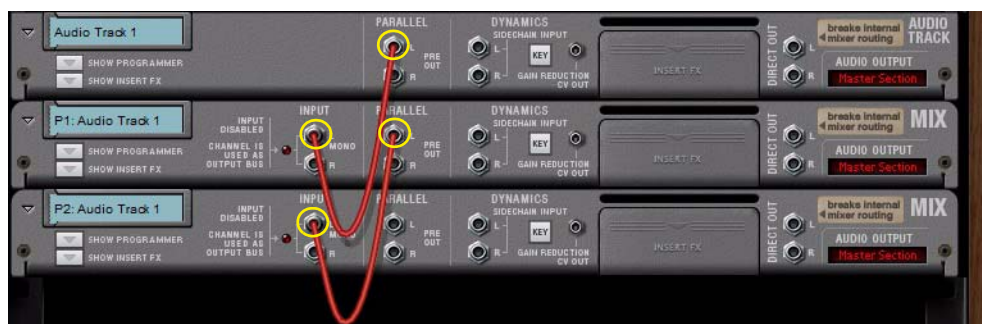

Source device

Parallel channel 1

Parallel channel 2

Parallel Channels 1 and 2 for the Audio Track 1 source channel in the rack.

- ! Since the Audio Track/Mix Channel device only has one pair of Parallel out jacks, any additional parallel channels have to be created from the last created parallel channel.

If your original channel is in mono, only the left parallel output is connected to the left input of the parallel channel.

- Now, you can create Insert FX in each of the parallel channels and process the signal of your source channel separately, in parallel.
- It might also be a good idea to create a separate Output Bus for the source channel and all parallel channels, see **“Creating an Output Bus”**.

## Creating a Parallel Output Bus

Parallel channels can also be created for Output Bus channels, for parallel processing of the entire Bus signal. The following example shows a drum kit, with a channel for each drum, that we want to assign to an Output Bus and apply parallel compression to:

1. [Shift]-select all drum channels in the mixer.

2. Press [Ctrl]+[G](Win) or [Cmd]+[G](Mac) to create a new Output Bus to automatically route the drum channels to.

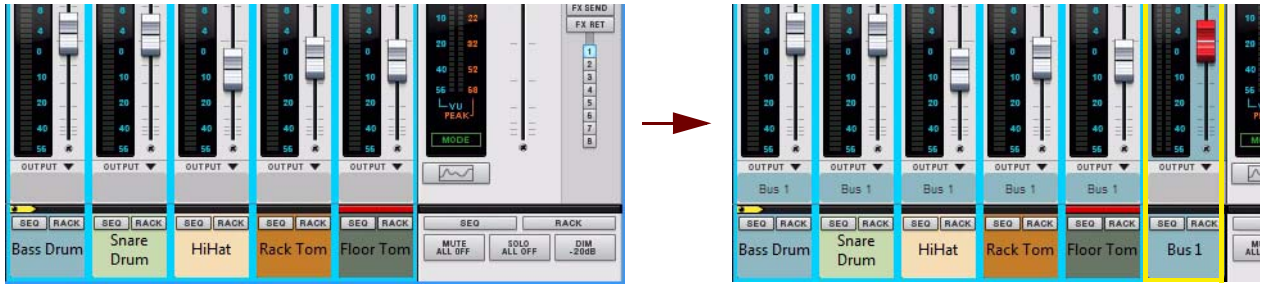

A new Output Bus channel, named “Bus 1”, is created to the right and the selected channels are automatically routed to it as indicated on the channels’ Output labels.

3. Select the “Bus 1” channel in the mixer and select “Create Parallel Channel” from the Edit menu or context menu.

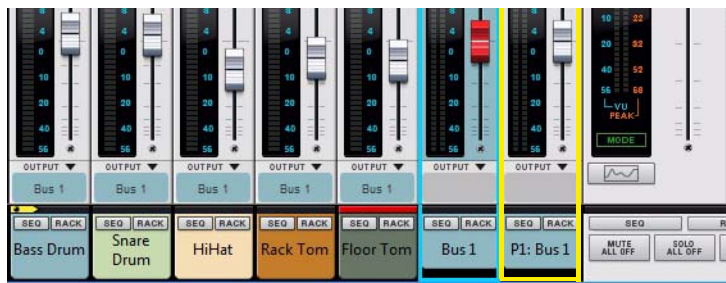

A parallel channel, the “P1: Bus 1” is created and the “Bus 1” Output Bus channel is automatically connected to it.

4. Activate the Compressor in the “P1: Bus 1” parallel channel and raise the Compression Ratio up high.



5. Raise the Level fader on the “P1: Bus 1” channel to gradually introduce the heavily compressed sound (in parallel with the dry signal of the “Bus 1” channel).

## Deleting Parallel Channels

- To delete a Parallel Channel, select its mixer channel strip - or its device in the rack - and press **[Delete]** or **[Backspace]**.

Confirm the deletion in the alert that appears.

## Naming Parallel Channels

When you create a Parallel Channel it is automatically named after its source channel according to: “P1: <source channel name>”, where “P” stands for Parallel and “1” for the first parallel channel. If you add on more parallel channels, the following channels are named “P2: <source channel name>” and so on.

If you change the name of the source channel, all the parallel channel are automatically renamed accordingly. You can then manually rename each parallel channel afterwards if you like.

- To revert to the automatically generated name, double-click the parallel channel’s name, press **[Delete]** or **[Backspace]** and then **[Enter]**.

# Solo, Mute and Send FX logic

The Solo, Mute and Send FX functions in the channel strips are very straight-forward when you work with mixer channels that are routed straight to the Master Section. However, when you are using Output Busses for sub-mixing and/or Parallel Channels for parallel processing, the Solo, Mute and Send FX functions need to work intelligently to provide the desired result. This has been carefully taken care of in the Main Mixer in Reason.

## Solo and Mute logic

The Solo and Mute functions are designed to work intelligently in the following special scenarios:

- **When several mixer channels are routed to an Output Bus.**
- **When a mixer channel has one or more Parallel Channels.**
- **When Output Busses are routed to other Output Busses.**
- **When Output Busses have Parallel Channels.**

## Solo and Mute examples

There are two ways a mixer channel can be soloed or muted:

- **Manually, by clicking the corresponding Solo or Mute buttons.**  
In these situations, the buttons light up in green (Solo) or red (Mute).
- **Automatically, according to the state(s) of the other mixer channels.**  
This happens when another mixer channel is affected by a manual Solo/Mute in another mixer channel. Automatically soloed/muted buttons light up in dimmed green (Solo) or dimmed red (Mute) color.

The examples in the figure below show how Solo and Mute work in different mixer channel configurations:



The Snare channel has been manually soloed.

Since the Snare channel is routed to the Drums SubMix Output Bus, the Drums SubMix bus is automatically soloed to let the Snare signal through to the Master Section.

All other mixer channels are automatically muted.

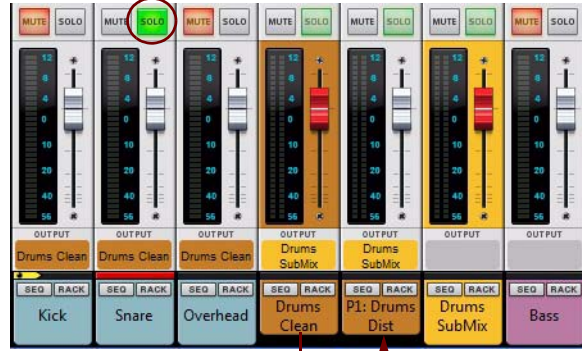

**Parallel**

The Snare channel has been manually soloed.

Since the Snare channel is routed to the Drums Clean Output Bus, the Drums Clean Output Bus is automatically soloed to let the Snare signal through.

The Drums Clean Output Bus is routed to the Drums SubMix Output Bus. The Drums Clean channel also has a parallel channel; the Drums Dist, which is also routed to the Drums SubMix Output Bus.

This means that the Drums Clean, Drums Dist and Drums SubMix channels are automatically soloed to let the Snare signal through to the Master Section.

All other mixer channels are automatically muted.

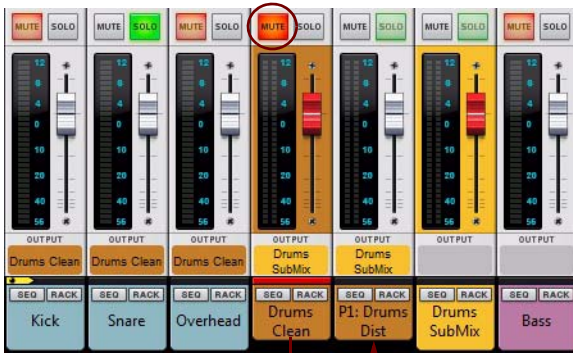

**Parallel**

Now, if we manually mute the Drums Clean Output Bus channel from the previous example, its automatic solo is disabled, allowing you to hear the sound of the Drums Dist bus only.

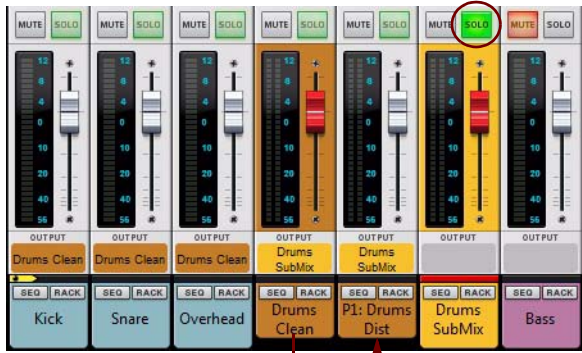

**Parallel**

If we start from scratch again and click the Solo button in the Drums SubMix channel, all channels routed to the Drums SubMix Output Bus are automatically soloed.

All other mixer channels are automatically muted.



Below is another example of the Solo and Mute logic:

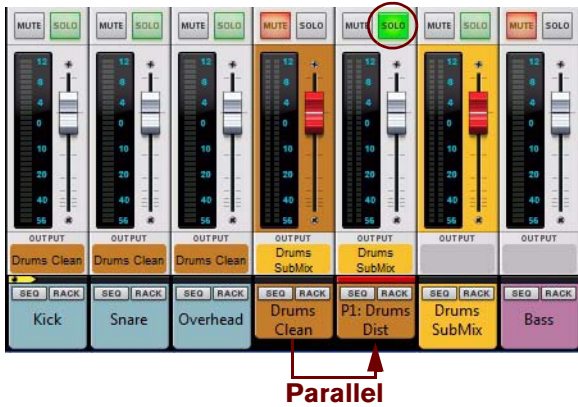

*The Drums Dist parallel channel is manually soloed.*

*Its output bus, the Drums SubMix, is automatically soloed, as are the Kick, Snare and Overhead channels that are routed to the Drums Dist channel via the parallel connection from the Drums Clean channel.*

*The Drums Clean channel is automatically muted, as are the other remaining channels in the mixer.*

## Send FX level and mute logic

If you are using Send FX in your mixer channels, these need to behave intelligently when you are using Output Bus channels and/or Parallel Channels.

### Send FX level examples

Since the eight Send FX busses in the Main Mixer are shared between all mixer channels, including Output Bus channels, there has to be a way to compensate the Send FX levels for changes in Output Bus levels. Therefore:

- **If a channel is routed to an Output Bus, its Send FX levels will follow the Output Bus level.**  
One example would be if you have a number of drum channels routed to a “Drums” Output Bus, and add a reverb to the Snare channel using an FX Send. Now, if you raise or lower the Drums Output Bus level fader, the individual Snare reverb Send level will automatically adjust, so that the effect balance is maintained.
- ! **Note that the automatic Send FX level adjustment is disabled if the Send FX PRE button is on.**
- ! **Note that the individual FX Send level knobs will not move to reflect the automatic level compensations.**

## Send FX mute examples

The example in the figure below shows how the Send FX behave when an Output Bus channel is muted:

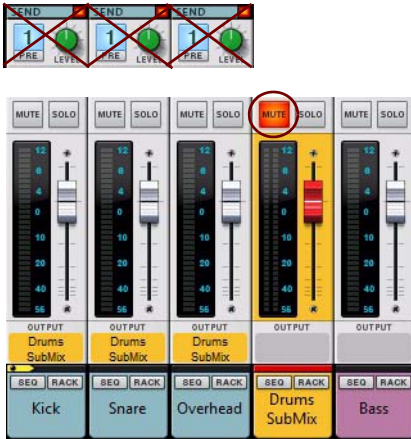

The Send FX outputs of all channels that are routed to the Drums SubMix Output Bus are automatically muted if you manually mute the Drums SubMix Output Bus channel.

The examples in the figure below show how the Send FX behave when you mute a Parallel Channel as well as a Parallel Channel plus an Output Bus:



Parallel

The Drums Clean Output Bus is manually muted.

Since the Drums Clean output bus is connected to an unmuted Parallel Channel, the Drums Dist channel, the Send FX outputs of the Kick, Snare and Overhead channels are not muted. However, if you should manually mute the Drums Dist channel, the Send FX outputs of the Kick, Snare and Overhead channels should be automatically muted.

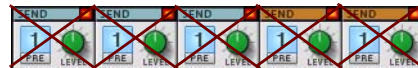

Parallel

Now, if you also manually mute the Drums SubMix Output Bus, the Send FX outputs of all channels that eventually end up in the Drums SubMix Output Bus will be automatically muted.

# Remote controlling the Main Mixer

There are two ways of Remote controlling the Main Mixer: one channel at a time, for detailed control of the parameters of one mixer channel at a time, or multiple channels simultaneously, for balancing levels etc.

## Remote controlling a single mixer channel

You can control a single mixer channel, either by locking your control surface to the mixer channel, or by setting Master Keyboard Input to the mixer channel's track in the sequencer.

For example, if you set Master Keyboard Input to the audio track you're recording on, you will be able to adjust the monitor level and other parameters of the channels you're using when recording.

The extensive Remote control functionality in Reason allows for detailed control of the parameters of one mixer channel at a time.

## Remote controlling multiple mixer channels

The typical way of remote controlling the Main Mixer is to control the Master Section (by setting Master Keyboard Input to the Master Section track in the track list, or typically by locking your control surface). This lets you control the Master Section parameters plus mixer parameters for a number of channels (often 8 channels at a time, depending on the control surface). To define what channels to remote control at a given time, you need to set the "Remote Base Channel".

### Setting the Remote Base Channel

The first (leftmost) mixer channel controlled by Remote is called the "Remote Base Channel". The current Remote Base Channel is indicated by a yellow arrow symbol in the mixer channel strip Header section:



*The Remote Base Channel indicator.*

To change the Remote Base Channel, proceed as follows:

- **Select a mixer channel and select "Set Remote Base Channel" from the Edit menu or context menu.**  
The Remote Base Channel indicator will move to the selected mixer channel.
- **Alternatively, change Remote Base Channel via Remote (in steps of 1 or 8 channels).**  
Functions for changing the Remote Base Channel may already be mapped to buttons on your control surface - see the "Control Surface Details" pdf document. If not, you can set this up manually in the Additional Remote Overrides dialog on the Options menu - see "[Additional Remote Overrides...](#)".

## Remote controlling multiple mixer channels - an example

If you want to remote control several channel strips at once from your control surface, you can proceed as follows:

→ **Select the Master Section device in the rack or the Master Section Strip in the Main Mixer.**

If you want to lock your control surface to the Master Section, select “Lock Xxxx to This Device” from the Edit menu or context menu. (“Xxxx” represents the name of your connected control surface.) This way, you can ensure that your control surface will always control the Main Mixer, regardless of where the edit focus is.



Selecting and locking the Master Section to the connected control surface.

Depending on your connected control surface, it may now be possible to control parameters of several channel strips at the same time. In this example, we're using a control surface which has nine sliders. These sliders are configured to control one channel strip Level Fader each, plus the Master Section Level Fader.

In the picture below, the Remote Base Channel is currently set to Audio Track 1. This means we can control the Level Faders of Audio Track 1 through Audio Track 8, plus the Master Section Level Fader, with the nine sliders on the control surface:

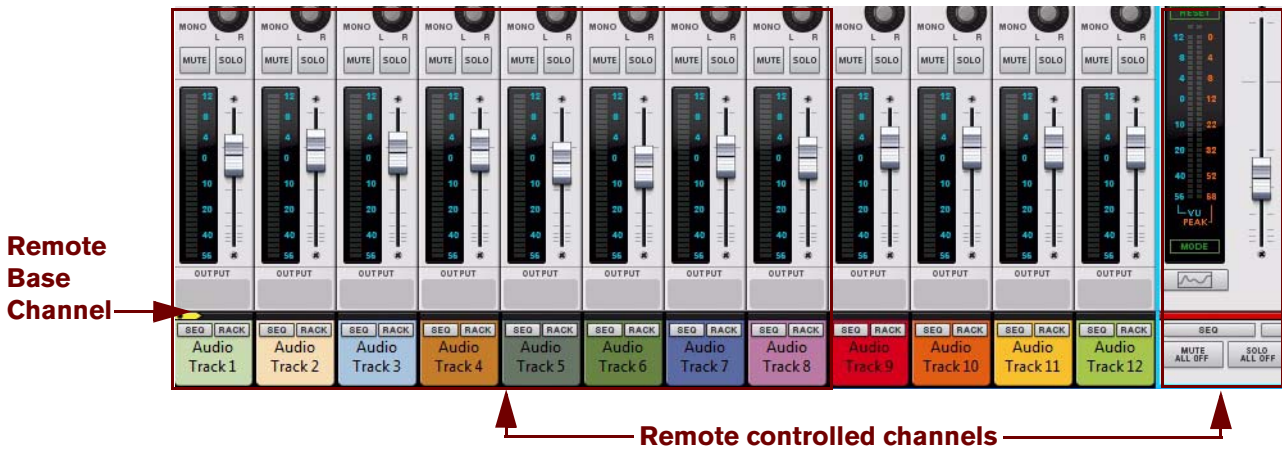

Controlling Audio Track 1 through Audio Track 8 and Master Section from the connected control surface.

On our control surface it's possible to select next and previous Remote Base Channel in steps of 8 channels. If we click the "Next" button on our control surface, the Remote Base Channel is set to Audio Track 9 and we can now control Audio Track 9 through Audio Track 12, plus the Master Section:

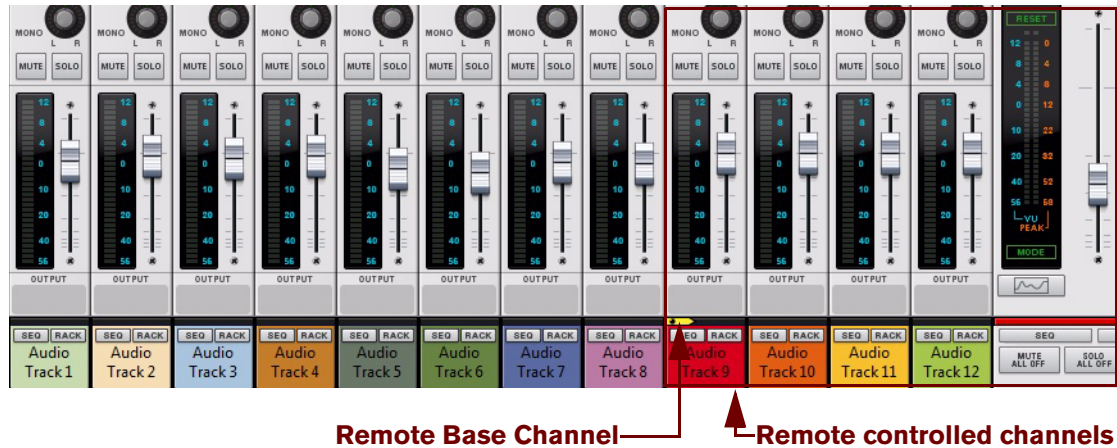

*Controlling Audio Track 9 through Audio Track 12 and Master Section from the connected control surface.*

If your control surface doesn't have buttons already assigned for controlling Remote Base Channel selection, you can manually assign controllers for this by using the Remote Override function described in ["Remote Override mapping"](#). Alternatively, select a channel strip and select "Set Remote Base Channel" from the Edit menu or context menu.

See ["Remote - Playing and Controlling Devices"](#) for more details about remote controlling Reason. See also the "Control Surface Details" pdf document for information about parameter assignments on various common control surfaces.

# Advanced routing tips and tricks

## Chaining Send effects from Redrum or Mixer devices

The Redrum Drum Module and the Mixer 14:2 and 6:2 devices have separate Send FX connectors where you can add send effects individually for each device. The Redrum and Mixer devices also have separate Send FX level pots for each drum/mixer channel so that you could set the send effect levels individually for each drum/mixer channel in the device.

Let's say you want to add a Redrum device and use two of the Main Mixer's Send FX, but with individual settings for each of the Redrum device's internal channels. In the example below, we're going to chain the two Send Outs from the Redrum device to two send effects in the Main Mixer:

**1. Create two extra Mix Channel devices - one for each of the send effects we're going to chain.**

In this example we name the Mix Channel devices "FX 1 Chaining" and "FX 2 Chaining".

**2. Activate the Send FX bus you want to use in each of the mixer channels and also activate the corresponding Pre-fader button.**

In this example, we activate the Send FX 1 bus on the FX1 Chaining channel and the Send FX 2 bus on the FX 2 Chaining channel. The Send FX 1 has a reverb connected and the Send FX 2 has a delay connected.

**! The PRE buttons should be activated because we don't want the mixer channel faders to affect the Send levels.**

**3. Lower the "FX 1 Chaining" and "FX 2 Chaining" mixer channel faders to zero.**

This way, the effect signals won't be mixed with the rest of the Main Mixer channel signals in the mix bus, but are kept isolated in the Send FX busses. Now, our setup should look like this in the rack and in the Main Mixer:



The device setup, plus two new Mix Channel devices added. To the right, the channel strips with activated FX Send busses.

**4. Connect the Send Out 1 and 2 of the Redrum device to the Left inputs of each of the “FX 1 Chaining” and “FX 2 Chaining” Mix Channel devices.**

Now, you should have a setup that looks something like this:

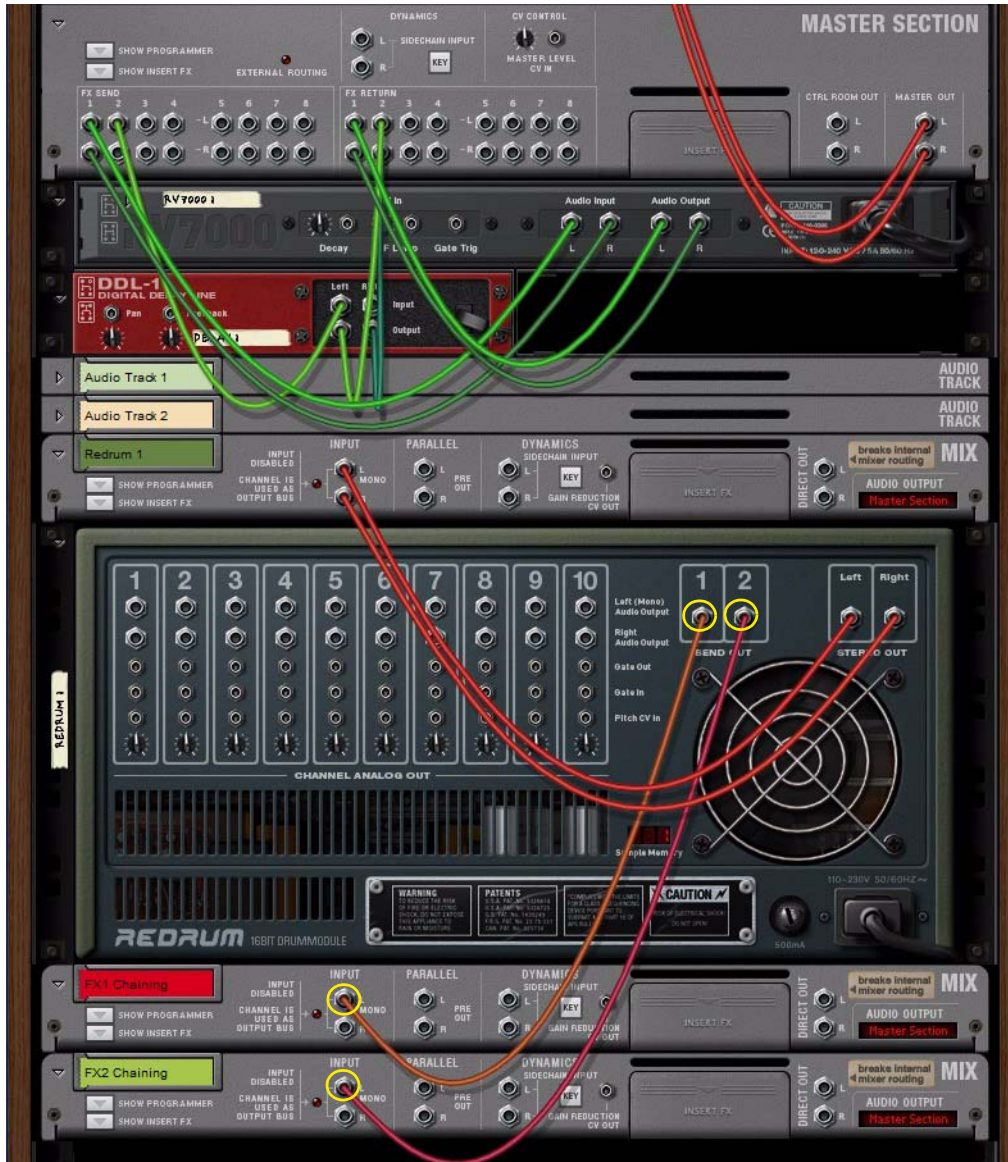

*The Redrum Effect Sends chained to one Send FX bus each of the Master Section, via two new Mix Channel devices.*

**5. Set individual Send levels for each of Redrum’s internal channels.**



Now, you have individual send levels for each of the Redrum device’s internal channels - and are still able to use the Send FXs in the rest of the Main Mixer channels like before.

# Using compression sidechaining

Compression sidechaining is a feature which lets you control the Compressor, not from the internal channel signal, but from an external signal. A typical use case would be to let the signal from a kick drum channel control the compression of the bass channel. The result would be that the bass signal is compressed each time the kick drum signal is present on the sidechain input, allowing the kick sound to momentarily suppress the bass sound.

## Compression sidechaining from an external channel

The example below shows an audio track with a kick sound that is tapped from the Kick Audio Track device's Parallel output and routed to the Dynamics Sidechain input of the Bass Audio Track device.

- **The Key button is automatically activated when you connect a signal to the Sidechain Input.**  
This will force the Compressor to be controlled from the Sidechain input signal rather than from the internal signal.



Compression Sidechaining of the Bass audio track from the Kick Drum audio track.



## About compression sidechaining of several channels from one source channel

If you want to use compression sidechaining of several (destination) channels from a single source channel, there are some options of doing that:

- **If you are already using both Parallel outputs for sidechaining, tap an additional sidechain signal from one of the Insert FX “To Device” outputs of the source channel.**

This is useful if you are not using both “To Device” outputs for insert effects in the source channel.

- **Use a “Spider Audio Merger & Splitter” device to split the sidechain signal from the Parallel outputs and/or Insert FX “To Device” output into several signals.**

Each of these signals can then be individually routed to each Sidechain Input of the desired destination Audio Track/Mix Channel devices.

- **Create an Output Bus (sub-mixer) and route all (destination) channels you want to control to this Output Bus. Then, route the sidechain signal from the source channel device to the Sidechain Input of the Output Bus Mix Channel device.**

See “Output Busses” for information.

## About internal compression sidechaining

Another typical application for compression sidechaining is to use the internal signal of the channel, filter it, and then feed to the compressor via “internal” sidechaining. This type of internal sidechaining can be used for de-essing, for example. No additional patching is required for this; you only have to activate the “Filters to Dynamics Sidechain” button in the Filter or EQ sections. See “About the Filters To Dynamics Sidechain button”.

## Using the Mix Channel and Audio Track devices’ Direct Outs

The Mix Channel and Audio Track devices feature Direct Out connectors. By patching cables into these outputs, you break the internal signal chain from the device to the Master Section, and can route the channel output signals directly to the Reason Hardware Device’s outputs. This is a very nice feature if you want to use outboard mixing or summing - or if you’re using ReWire (see “ReWire”) to route individual channel signals to another application.

The example below shows how to route the Direct Outs of a number of Audio Track devices to separate outputs of the Reason Hardware Interface:



*Direct routing of individual channel outputs to individual outputs on the Reason Hardware Interface.*

**! Using the Direct Outs will break the internal P-LAN routing to the Master Section device. This is indicated by the red dashes (---) in the Audio Output display on the Audio Track/Mix Channel devices.**

## Creating an input channel for recording with effects

When you record on an audio track, the input signal is routed “dry” to the audio track. Then, when you play back the recorded audio, the signal goes via the channel strip, with all its settings and any Insert FX etc. However, there might be situations where you want to record a processed signal to the audio track. For example, if you record an electric guitar, you might want to record it with distortion effects or similar.

The example below shows a typical setup where a separate Mix Channel device is used for processing the input signal before it's routed to the audio track for recording:

### 1. Begin by creating an Audio Track device and a separate Mix Channel device.

The Mix Channel device is going to be used for housing the effects we're going to record with.

### 2. Create the effect(s) you want to use and patch them as Insert FX in the Mix Channel device.

In this example, we use a Line 6 Guitar Amp and an RV7000 reverb device connected in series.

3. **Connect one of the Audio Ins of the Reason Hardware Interface to the “Input L” of the Mix Channel device.**  
This manual patching from the Hardware Interface is made to route the input signal directly to the Mix Channel device, where we have our effects.



*Direct routing of an Input signal from the Reason Hardware Device to the Mix Channel device.*

4. **Flip the rack around to view the front.**
5. **Click the “Rec Source” button on the Mix Channel device.**  
This makes the Mix Channel device selectable as input source for the Audio Track device.



*Rec Source enabled on the Mix Channel device.*

**6. Finally, select the Mix Channel device as Input on the Audio Track in the sequencer (or in the Audio Input selector on the Audio Track device in the rack).**

This will route the signal from the Mix Channel device's output directly to the input of the Audio Track.



*The Mix Channel device selected as audio input on the Audio Track in the sequencer.*

Now, you can begin recording on the Audio Track according to the standard recording procedures described in [“General recording procedure”](#). The signal will be processed by the Insert FX of the Mix Channel device before being recorded on the track.

With this setup, you will always hear the sound of the input processed through the Amp device - just as if you had a real hardware amp turned on and mic'ed in the studio. If you don't want the “Lead Gtr Rec Input” Mix channel to be heard, just mute it in the Main Mixer.

# **Chapter 16**

## **Song File Handling**

# About this chapter

This chapter describes how to open, create and save songs in various ways. It also describes how to save a song as a Template and how to import and export songs as Standard MIDI files.

## Opening Songs

### Opening a Reason or Record Song

! **To be able to open a Reason Song (or a Record Song), you need to run Reason in Authorized mode. If you're using Reason in Demo Mode (unauthorized), the "Open" item on the File menu is removed and replaced by "Open Demo Song". This allows you to open only the factory made Reason Demo Songs (see "Opening a Reason Demo Song"). See "Running Reason on an authorized computer - or with an authorized Ignition Key hardware" and "Running Reason with Internet Verification" for details on how to authorize Reason.**

To open a Reason Song:

→ **Double click the Song file in Windows Explorer (Win) or in Finder (Mac).**

Or, if you want to open a Song file from within the program:

**1. Hold down [Ctrl](Win) or [Cmd](Mac) and press [O], or select "Open" from the File menu.**

The Browser appears (if it was hidden) in the Song window.

! **If no Song document was open on the Mac OS X version of Reason, Reason temporarily opens an empty Song document to be able to show the Browser. When a Song has been loaded, the empty document closes.**

**2. Navigate in the Browser to the desired folder on disk or within a ReFill.**

See "Using the Browser" in the "Sounds and Patches" chapter.

**3. When you have located the Reason (.reason, .rsndemo, .ree, .reedemo, .rltd, .rns, .rps or .rsb), or Record Song file (.record or .recdemo), select it and click "Open" (or double click the file).**

The song opens in a new document window.

→ **You can have several Songs open at the same time if you like. This allows you to drag and drop (and copy and paste) patterns, clips and patches between songs. However, all open songs consume some memory and processing power, so you might want to close songs you don't need for the moment.**

→ **It's also possible to have Reason open the last song you worked on as soon as you launch the program. See "Opening the last Song at program launch" for more information.**

### If the "Missing Sounds" window appears

If the song includes samples or REX files, and these have been moved or renamed since the song was saved, the program will inform you that it cannot find all files. You can then choose to either manually locate the missing files, to have the program search for them or to proceed without the missing sounds. For details, see "Handling Missing Sounds" in the "Sounds and Patches" chapter.

### If "Missing Device" panels appear in the rack

When you open a Reason song made by another user, it may have been created with Rack Extension devices that you don't have. All such missing devices in a song will be replaced by generic "Missing Device" placeholder devices. See "About missing Rack Extensions" for more information.

## About opening Reason Version 5 (or earlier) Songs in Reason Version 8

If you run Reason in Authorized mode, it's also possible to open older Reason (.rns, .rps and .rsb) songs. A Reason Song created in Reason Version 5 or earlier will end up in a separate Song document, just like an ordinary Reason Version 8 Song. All Rack device and sequencer track configuration will be preserved as well as all cable connections. The only things that will be changed are these:

- **The Main Mixer Master Section will be connected to Outputs 1 and 2 of the Reason Hardware Interface.**
  - **The Rack device that was connected to outputs 1 and 2 on the Reason Hardware Interface in the old song will now be connected to a new Mix Channel device, below the Master Section device in the Rack.**
  - **If there were any more connections to the Reason Hardware Interface in the song, these will now be connected to new mono Mix Channels.**
  - **Below the Mix Channel devices in the Rack, the devices from the Reason song will appear in a single rack column, just like they did in the earlier version of Reason.**
- ! **If you open a Reason Published Song (.rps), you cannot save etc., and the “Export Audio” and “Bounce Mixer Channels” functions will only work if you haven't manually changed anything in the Song document.**
- **If you want to re-route the instrument devices from the 14:2 Mixer in the old Reason Song to separate Mix Channels in the Reason Version 8 Song, there is kind of a semi-workaround for this, see [“About re-routing devices in songs created in Reason Version 5 or earlier”](#).**

## Opening a Reason Demo Song

Reason Demo Songs are factory made songs that demonstrate how Reason can be used in various musical projects. If you run Reason in “Demo Mode” (unauthorized), you will only be able to open Demo Songs - but not regular Songs. If you run Reason in authorized mode, the Open Demo Song item is available in addition to the regular Open item.

- **Select “Open Demo Song” from the File menu and select a Demo Song from the sub-menu.**

You could also select “Download more Demo Songs” from the sub-menu. This will open your default web browser and direct you to the Reason Demo Songs page on the Propellerhead web site. On this page you can download additional Reason Demo Songs to your computer. You will then have to use the “Open Demo Song” command from the File menu to open the downloaded Demo Songs.

- **You can also download more Reason Demo Songs by selecting “Download more Demo Songs” from the Help menu.**
- **You can have several Demo Songs open at the same time if you like. This allows you to drag and drop (and copy and paste) patterns, clips and patches between songs. However, all open songs consume some memory and processing power, so you might want to close songs you don't need for the moment.**

## Opening the last Song at program launch

It's possible to instruct Reason to automatically open the last Song you worked on each time you launch Reason. You select this on the “General” tab in the “Preferences” dialog.

1. **Select “Preferences” from the Edit menu (Win) or “Reason” menu (Mac) and then click the “General” tab.**

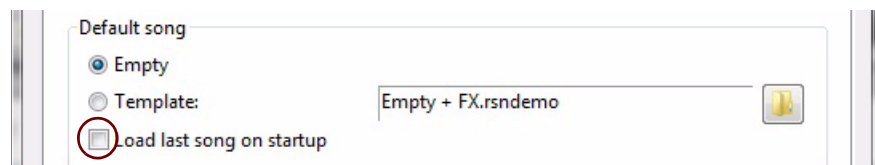

2. **Tick in the “Load last song on startup” checkbox.**

When you launch Reason the next time, the last saved Song will automatically open in a document window.

# Closing Songs

## Closing a Song

- To close a Song, hold down [Ctrl](Win) or [Cmd](Mac) and press [W], or select “Close” from the File menu. Alternatively, click the close button in the upper corner of the Song document window.  
If you have unsaved changes, you will be asked if you want to save the song before closing.
- ! Note that when you’re closing the last open Song document in the Windows version of Reason, the Reason application will quit.

# Creating Songs

## Creating a new Song

- To create a new song, hold down [Ctrl](Win) or [Cmd](Mac) and press [N], or select “New” from the File menu. A new Song document window appears. By default, the new Song contains the following:
  - The Reason Hardware Interface.
  - The Main Mixer Master Section with its Master Section device in the Rack.  
The Master Section device’s Master Out L & R are connected to the Reason Hardware Interface Audio Out 1 & 2.
  - The Transport Track at the top of the Sequencer.
- Instead of creating an empty song each time you select “New”, it’s possible to automatically load an existing song to use as template for your new songs. For example, if you want to start with your own unique selection of devices, you can create and save a song and then instruct Reason to use this song each time you create a new song. See “Setting up a Default Song”.
- An alternative to creating a new song is to use the “Create New from Template” command to open one of the factory made Template Songs. See “Creating a new Song from a template”.

## Setting up a Default Song

It’s possible to specify a certain Song document which will automatically open as a “template” each time you select “New” from the File menu. The Default Song could be any Song you have created earlier, or a factory made Template Song. You can select this Default Song on the “General” tab in the “Preferences” dialog.

1. Select “Preferences” from the Edit menu (Win) or “Reason” menu (Mac) and then click the “General” tab.

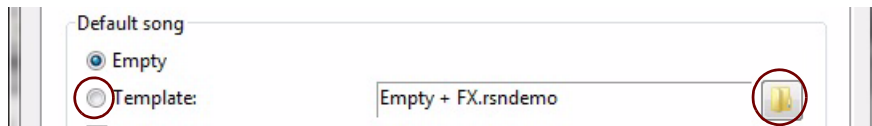

2. Click the “Template” radio button in the “Default Song” section.
  3. Click the folder icon to the right and select the Song you want to use as a template when creating new Songs. Each time you create a new Song (by selecting “New” from the File menu), the selected Song will be loaded and used as a template for your new Song. On Windows platforms, the Song document will be named “Document n” where “n” is an incremental number. On Mac OS X platforms, the document will be named “untitled n” where “n” is an incremental number. You can then save your Song with a new name.
- ! Make sure the “Load last song on start-up” checkbox is not ticked, otherwise the last song will be opened instead of the Template song you selected.



## Creating a new Song from a template

- **To create a new song from a Template, select “New from Template” from the File menu and then select one of the Template Songs that appear in the sub-menu.**

The selected Template Song appears in a new document window. On Windows platforms, the document will be named “Document n” where “n” is an incremental number. On Mac OS X platforms, the document will be named “untitled n” where “n” is an incremental number. You can then save your Song with a new name.

- **You could also create your own Template Songs and make them appear in the sub-menu. See “Making a Song appear as a Template Song”.**
- **You can also download more Reason Template Songs by selecting “Download more Template Songs” from the Help menu.**

## Saving Songs

### Saving a Song

You will always be able to save your Songs in Reason. It doesn't matter if you're running in authorized or unauthorized (Demo) mode.

#### The “Save” function

To save a Song, proceed as follows:

- 1. Hold down [Ctrl](Win) or [Cmd](Mac) and press [S], or select “Save” from the File menu.**

If this is the first time you're saving the song, a file dialog will appear where you can specify a name and destination.

- 2. Specify a name and destination for the Song and click “Save”.**

Once you have saved a song, selecting “Save” will simply save it under the same name and in the same location, without showing a dialog.

- **It's also possible to automatically include all samples used by the Reason devices and make the Song “self-contained”.** Refer to **“About Self-Contained Songs”** for details about how to include your own samples in your songs.
- **To reduce the file size of your song, you can use the “Save and Optimize” command described in “Saving and optimizing a Song”.**
- **It's also possible to include detailed information about your song.** Refer to **“Including Song Information”** for more details.

#### The “Save As...” function

To save an existing Song under another name and/or in another location:

- 1. Hold down [Ctrl]+[Shift](Win) or [Cmd]+[Shift](Mac) and press [S], or select “Save As...” from the File menu.**

The “Save As” dialog appears.

- 2. Specify a new name and/or new destination for the Song and click “Save”.**

- **Using the “Save As...” function will automatically optimize the Song (see “Saving and optimizing a Song”).**

## Saving and optimizing a Song

When you record audio in the Sequencer, the recordings are stored in your Song document. If you remove recordings in your song while editing, there might be “empty” areas left in the document, similar to a fragmented hard disk. To “defragment” the Song document, and thus reduce the file size, you can use the “Save and Optimize” command on the File menu. Note that the “Save and Optimize” command can only be used on previously saved Song documents.

→ **Select “Save and Optimize” from the File menu.**

The Song will be optimized and saved at the original location.

**! Note that saving and optimizing a Song could take a couple of minutes if you have lots of audio recordings in it. Therefore, the best alternative would probably be to use the “Save” command while you’re still working with your Song, and then use the “Save and Optimize” command as a final step when you’ve finished editing.**

→ Using the “Save As...” function automatically optimizes the Song.

→ In some situations, it’s possible to reduce the file size even further by deleting any recordings you haven’t used in your Song. See **“Delete Unused Recordings”**.

## Including Song Information

Selecting “Song Information” on the File menu opens a dialog in which you can add information about your song. For example, if you plan to send the song to other Reason users, this dialog allows you to add contact information, comments about the song, etc.

→ **Select “Song Information...” from the File menu.**

The Song Information dialog opens.

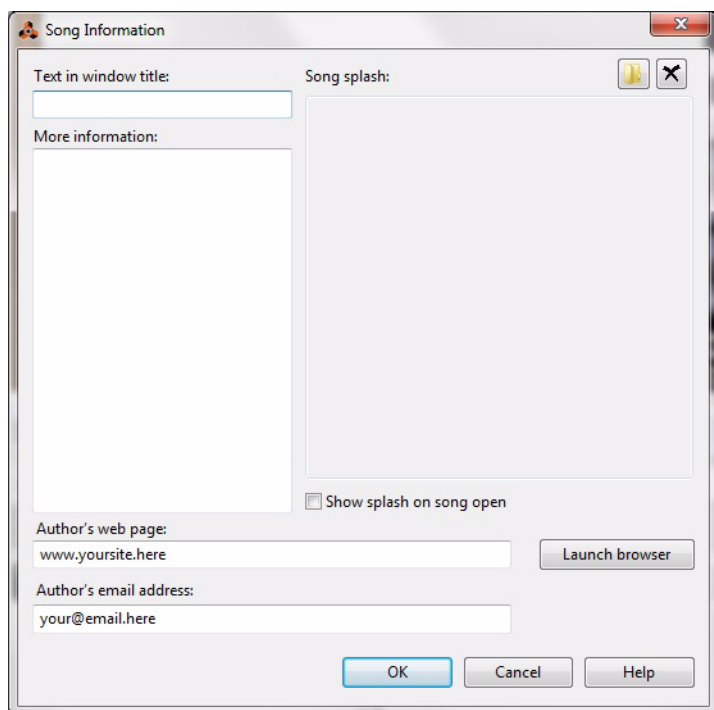

The Song Information dialog contains the following items:

- **Text in window title:**

The text you add here will be displayed directly after the file name in the song window’s title bar.

- **More information:**

This is where you could add notes and comments about your song.

- **Song splash:**

This allows you to add a picture to the song. The picture will be displayed when the song is opened.

→ **To add a splash picture, click the folder button at the upper right corner, locate and open the picture file in the file dialog that appears.**

! **Splash pictures must be JPEG files (Windows extension “.jpg”) with a size of 256 x 256 pixels.**

→ **To remove the splash picture from the song, click the “cross” button at the upper right corner.**

→ **Tick the “Show splash on song open” check box to make the splash appear every time the song is opened.**

- **Author’s web page:**

Here, you can type in your web site URL. When a user opens your song, he/she can go directly to your web site by clicking the Browse button that appears in the splash (provided there’s an Internet connection available).

- **Author’s e-mail address:**

Here, you can specify your e-mail address if you want other Reason users to e-mail you their comments, etc.

## About Self-Contained Songs

The Song is the main file format in Reason. A Song contains the device setup and all settings and connections in the Rack, all Main Mixer Channel settings as well as everything you have recorded in the Sequencer. However, this is not always sufficient. If you want to open your song on another computer, or send it to another Reason user, you will also need to include all samples and REX files used by the Reason devices in the Song. To make this easier, Reason allows you to create “self-contained” songs. A self-contained song contains not only the references to the used samples and REX files, but also the files themselves. You can choose exactly what files should be included in the self-contained song.

– **An alternative to self-containing samples and/or REX files could be to bounce Mixer Channels to Audio Tracks. This way, you could “convert” ReFill samples to audio so that your song would always sound the same, no matter on which computer you play it back. See “Bouncing Mixer Channels” for details.**

To specify what files should be included in the self-contained song, proceed as follows:

1. **Select “Song Self-Contain Settings...” from the File menu.**

The “Song Self-Contain Settings” dialog appears, listing all samples and REX files used in the song:

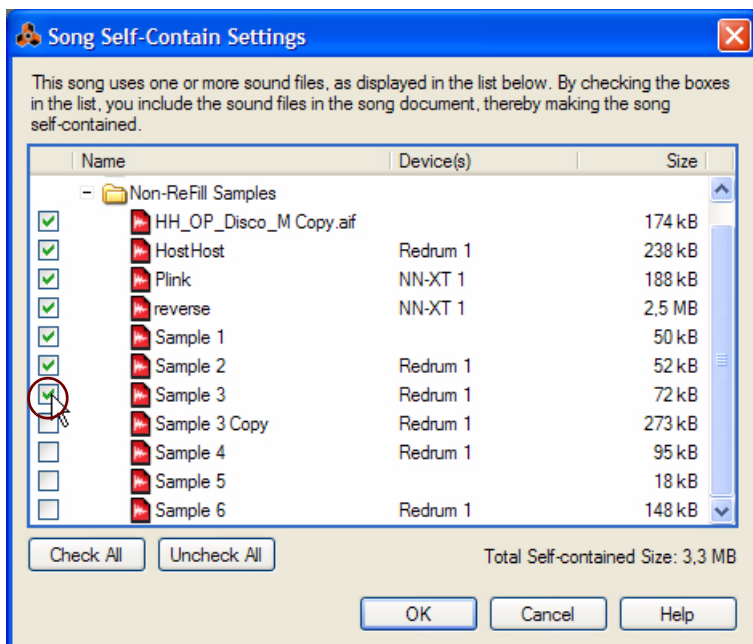

**2. Tick the checkboxes to the left of the “Name” column for the files you want to contain in the song.**

Note that samples and REX files from ReFills can also be self-contained (but not un-self-contained, see below).

→ **You can use the “Check All” button to tick all checkboxes in one go.**

Similarly, the “Uncheck All” button unchecks all checkboxes.

**3. When you have marked the desired sounds, click “OK” to exit the dialog.**

The next time you save your Song, the specified sounds will be automatically included in the Song file.

**! Note that a self-contained song file will be larger than the original song file. However, samples included in a self-contained song are automatically compressed by approximately 50% of their original size. Since the compression is lossless, this does not in any way affect the sound quality.**

## “Un-self-containing” a Song

If you have a self-contained song which contains one or several sounds embedded in the song file, you may want to extract these sounds and make the song refer to them on disk as usual. This is done in the following way:

**1. Select “Song Self-Contain Settings...” from the File menu.**

The “Song Self-Contain Settings” dialog appears.

**2. Locate the sounds you want to extract from the song file, and deactivate their checkboxes (or click the “Uncheck All” button).**

**3. Click “OK” to close the dialog.**

Now, Reason will check for each “extracted” sound file whether it is available (at its original, stored location) or not.

**• If the program finds the sound file at the location stored in the song, it is simply removed from the song file, and the original file reference path is used.**

This would be the case if you made the song self-contained yourself, and un-self-contain it on your own computer (provided that you haven't removed the original sound files from disk since you made the song self-contained).

**• If the program doesn't find the sound file, a file dialog appears, allowing you to select a folder and name for the sound file.**

The extracted file will be saved in the specified folder, and the path in the song will be adjusted. This would be the case if you were given the self-contained song by another user, for example.

**! Note that it is not possible to un-self-contain samples that originate from ReFills!**

**! If you un-self-contain samples that were modified in the Edit Sample Window and feature Start and End Markers and/or loop crossfades, the Lossy Sample Export dialog appears. The available options are described further down in the “Exporting samples” section in the Sampling chapter. Note that the option you select in the Lossy Sample Export applies to all samples you have deselected in the Song Self-contain Settings dialog!**

## Making a Song appear as a Template Song

If you want Songs you have created to appear on the “New from Template” sub-menu, and be available for selection when you use the “New from Template” command (see “Creating a new Song from a template”), you need only move or copy the Song(s) to the Template Songs folder in the application folder on your hard drive. The easiest way to get to this folder is by selecting File|New from Template|Show Template Folder. This brings up the Template folder in Windows Explorer or Finder on Mac.

## A note about saving Songs as audio files

It's also possible to export your Songs as audio files in WAV or AIFF format. Refer to “Exporting Songs or parts of Songs” for more information.

# Audio data and Scratch Disk settings

## About audio data in Song files

If you record or import audio into an unsaved Song document, the audio is written to the “Scratch Disk folder” on your computer. As soon as you save (and name) the Song document, the audio is moved from the Scratch Disk folder to the Song document. From here on, all new recorded and/or imported audio is stored in the Song document.

## Changing Scratch Disk folder location

The Scratch Disk is where Reason stores new, unsaved songs, plus analysis data (waveform data and high-quality time stretch/transposed audio/sample rate conversion data).

By default, Reason places the Scratch Disk folder in the system temp folder in your home directory. You can change the Scratch Disk folder location if you like:

1. **Select “Preferences” from the Edit menu (Win) or Reason menu (Mac) and then click the “Advanced” tab.**

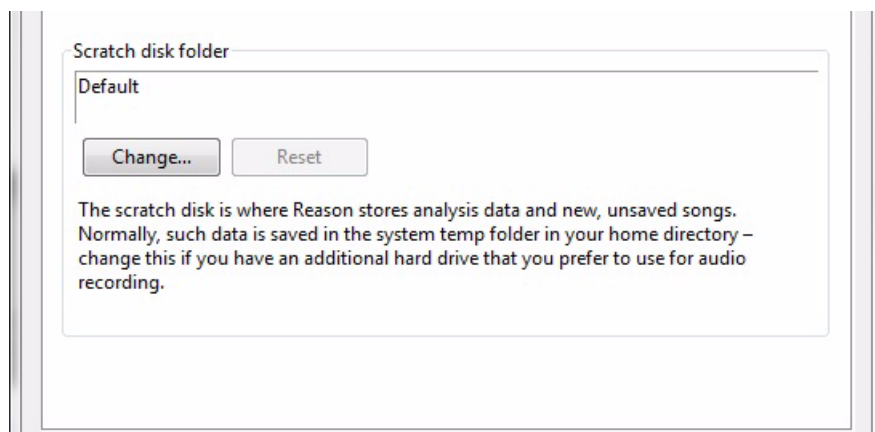

2. **Click the “Change” button in the Scratch Disk Folder section.**

A system folder browser opens where you can select - or create - a new folder.

3. **Select the folder where you want to locate the Scratch Disk Folder and click “OK”.**

4. **Restart the computer and relaunch Reason.**

- **If you later want to revert to the default setting, click the “Reset” button on the “Advanced” tab.**

The custom Scratch Disk Folder setting is removed and is replaced by the default setting. You will then have to restart the computer for the change to take effect.

## About unavailable Scratch Disk Folder

If a custom assigned Scratch Disk Folder isn't available when you launch Reason, an alert saying: "The selected Scratch Disk folder isn't available. Reason will use the default scratch disk for this session." is shown. This could happen if you have assigned the Scratch Disk folder to a removable disk and that disk is currently unavailable.

- **Click “OK” to use the default Scratch Disk Folder.**

The next time you launch Reason, it will look for the custom assigned Scratch Disk Folder again, and will do so every time you launch Reason, until you reset the custom assignment by clicking the “Reset” button.

## About “Orphan Audio Streams”

If your computer should malfunction (due to power loss etc.) during recording into a previously saved Song document, there is a good chance that your last unsaved audio recordings can be (at least partly) recovered:

**1. Restart your computer and launch Reason.**

**2. Open one of the Song documents that was open during the computer malfunction.**

If the Song contained unsaved audio recordings, Reason will find these and show an alert saying that the Song contains “orphan audio streams”. You will be given the choice of deleting them or having them appear in new clips on a new audio track, for salvaging.

**! Note that it’s only audio recordings that it’s possible to recover. Any new Instrument Tracks in an unsaved Song will be lost in the case of computer malfunction.**

## Importing and exporting Standard MIDI Files

Reason can import and export Standard MIDI Files (SMF). This allows you to transfer MIDI data between Reason and other applications.

### Importing Standard MIDI Files

To import a Standard MIDI File to the Reason sequencer, follow these steps:

**1. Create a new, empty Song document.**

**2. Select “Import MIDI File...” from the File menu.**

The Browser appears (if it was hidden).

**3. Select a Standard MIDI File (.mid) in the Browser and click “Import”.**

A number of new tracks are created in the Reason sequencer. The tracks will have their original name, with their original MIDI channel added. Each track will be assigned an ID8 device, loaded with a sound that resembles the original sound. These assignments will only serve as a starting point to be able to play back the imported MIDI file. You may want to change sound, or replace the ID8 with another device if you have Reason installed.

- **The Note events in the MIDI file will be imported into one or several Note Clips on a Note Lane on each Track.**
- **If the imported MIDI file is a Type 1 MIDI file, there will be one sequencer track for each track in the MIDI file.**
- **If the imported MIDI file is a Type 0 MIDI file (that is, it contains one track with MIDI events on multiple channels), there will be one sequencer track for each used MIDI channel.**
- **The Tempo setting, any Tempo Automation and any Time Signature automation in the MIDI file will be recognized.**
- **All controller data in the MIDI file is included.**

This means that standard performance controllers (Pitch Bend, Mod Wheel etc.) are preserved properly and will be included in the note clip, just as when recording in Reason. If there are separate MIDI Controllers in the imported MIDI file, these will be imported to separate Automation Lanes on the Instrument Tracks. There is a chance that some controller data may be imported to alien clips, due to different interpretations of a controller by a device in the rack and the MIDI instrument used to create the MIDI file (see [“About alien clips”](#)).



*Green frames will appear for automated parameters on the ID8 device panels. This helps you locate any unwanted controller automation.*

# Exporting Standard MIDI Files

To export all Instrument Tracks and Automation Tracks from the Reason sequencer as a Standard MIDI File (SMF), do like this:

**1. Set the End Marker in the sequencer to where you want your song to end.**

The MIDI file will contain all MIDI events on all tracks from the start of the song to the End marker.

**2. Select “Export MIDI File...” from the File menu.**

The standard file browser appears.

**3. Type in a new file name (if desired) and select location for the file to be exported. Then, click “Save”.**

The default name for the MIDI File will be the Song’s name followed by the “.mid” extension.

MIDI files exported by Reason will have the following properties:

- **The MIDI file will be of Type 1, with one MIDI track for each track in the Reason sequencer.**  
The tracks will have the same names as in the Reason sequencer.
- **Since the Reason sequencer doesn’t use MIDI channels as such, all tracks will be set to MIDI channel 1.**
- **The sequencer Tempo, and any Tempo Automation and/or Time Signature Automation, is included in the MIDI file.**
- ! **Since an Instrument Track in Reason could consist of different types of devices (plus FX etc.), there is no information about the actual sound in the exported MIDI File. The exported MIDI File only contains information about each instrument track and its MIDI Notes and/or MIDI Controller data laid out on the track. You will have to manually assign appropriate sounds to each track in the importing application.**





# **Chapter 17**

## **Importing and Exporting Audio**

## About this chapter

This chapter describes the various techniques you can use to import and export audio to and from Reason. It also describes how you can drop songs and loops to Propellerhead.

## Importing audio

### Audio formats, sample rates and tempo matching

The Reason sequencer supports import of mono and stereo audio files of various formats, sample rates and resolutions. Reason also supports import of REX (ReCycle rcy, rex and rx2) files. You can import several audio files at the same time, with each audio file ending up on a separate Audio Track in the sequencer - or on separate Comp Rows in a selected Audio Clip. You can import files of different formats on the same Audio Track - or even in the same Audio Clip. One audio file could be an 8-bit mono file sampled at 22.05 kHz, the next a 24-bit stereo file sampled at 192 kHz, etc. Reason automatically converts sample rates and resolution with preserved audio quality. If the imported audio file includes tempo data that Reason supports, Reason automatically matches (stretches) the audio file to fit the current Song Tempo, without affecting the pitch.

- **if the imported audio files' sample rates differ from the current audio hardware sample rate, Reason will automatically sample rate convert.**

This will first be done with a real-time algorithm, allowing for immediate playback. In the background, a high-quality sample rate conversion is performed. This is indicated by the CALC indicator on the transport panel. When done, Reason will automatically switch to playing back the high-quality version and the CALC indicator will go out.



*The CALC indicator indicates when Reason performs high-quality stretching of audio.*

### About tempo matching imported audio

If you have imported audio to the sequencer, you could manually tempo match (stretch) audio clips in a couple of ways:

- **By using the Scale Tempo “tool” to manually stretch the audio clips, see “Tempo scaling Clips”.**
- **By using the Scale Tempo function in the Tool Window, see “Scale Tempo”.**

# Importing audio to the sequencer

! To minimize the song saving time, we strongly recommend to save the song before you import many or large audio files.

To import one or several audio files to tracks in the sequencer, proceed as follows:

1. Select “Import Audio File...” from the File menu, or hold down [Ctrl]+[Shift](Win) or [Cmd]+[Option](Mac) and press [I].

The “Import Audio File” function gets browser focus:

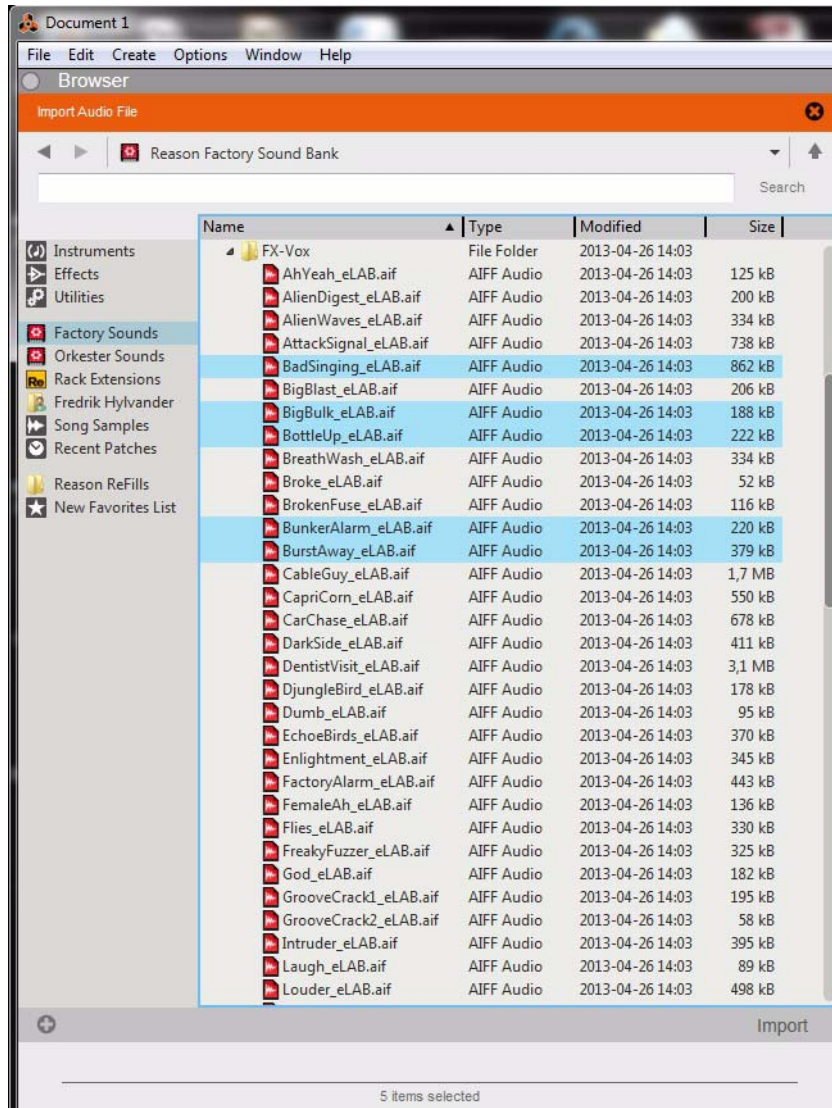

2. Browse and select the audio file(s) you want to import.

When you select a single audio file, information about length, format, size and tempo (if included in the file) is shown in the information section, below the Browse list. If you like, you can also preview selected audio file by clicking the “Play” button in the “Audition” section. If you select several audio files, the total number of files and their total size are displayed in the Details section. You will not be able to preview the audio files when several files are selected.

→ You can also import samples from the Song Samples location in the Browser.

! If you select a REX file, this will be rendered to audio when imported and all information about slice positions etc. will be lost. The Song Tempo and any Tempo Automation starting at the Song Position Pointer will be taken into account during the import. After the import, the REX file will behave just like any imported audio file.

! If you are going to edit the imported REX file inline, and work with slices, audio quantizing, stretching etc. Reason will automatically detect the transients in the audio and generate new slice markers that might not correspond to the original slice distribution of the imported REX file, see **“Editing audio inline”**.

**3. Click “Import” to import the audio file(s).**

Depending on the where the edit focus was when you selected “Import Audio File” from the Edit menu, the audio file(s) will be placed a little differently. In all scenarios, the imported audio file(s) will be placed at the current song position:

- If an audio track has edit focus in the sequencer track list and you have selected only a single audio file, the imported audio file will be placed in a new clip on this audio track.
- If you selected several audio files when using the Import Audio File command, each audio file will be imported to new audio tracks in the sequencer - in the order the files were selected in the Browser.
- If you selected only a single audio file and the edit focus is elsewhere in the application, a new audio track will be created for the imported audio file.

→ You can also drag one or several audio files from the Browser and drop in the sequencer track list.

The audio files will then be imported to separate audio tracks in the sequencer:

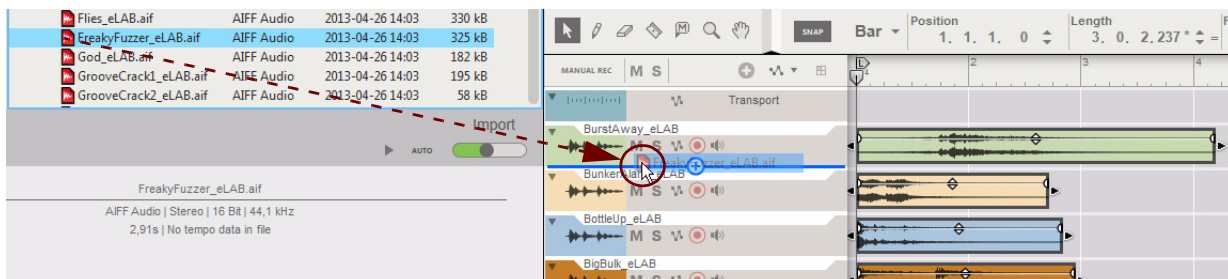

A + sign and a divider indicate where in the track list the imported audio file(s) will be placed.

→ You can also drag one or several audio files from the Browser and drop on an audio track on the Arrange Pane.

The audio files will then be imported as separate audio clips, after one another, on the corresponding audio track. If Snap is active in the sequencer, this will be taken into consideration:

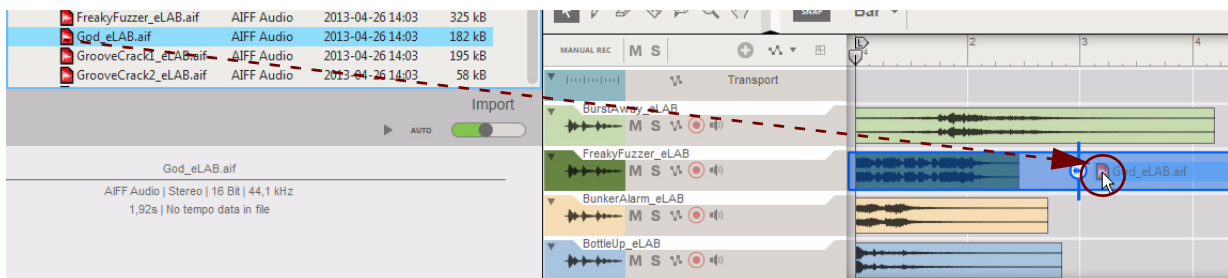

A waveform sign and an insertion point divider indicate where on the audio track the imported audio file(s) will be placed.

## Import audio file(s) to an open Audio Clip

It's also possible to import audio files to open Audio Clips in the Comp Editor in the sequencer. Proceed as follows:

**1. Open the Audio Clip you wish to import the audio file(s) to in the Comp Editor.**

**2. Select “Import Audio File...” from the File menu, or hold down [Ctrl]+[Shift](Win) or [Cmd]+[Option](Mac) and press [I].**

The “Import Audio File” function gets browser focus.

**3. Browse and select the audio file(s) you want to import.**

→ You can also import samples from the Song Samples location in the Browser.

! If you select REX files, these will be rendered to audio when importing. The Song Tempo and any Tempo Automation starting at the Clip position will also be taken into account.

**4. Click “Import” to import the selected audio file(s).**

The audio file(s) will be imported as new recordings on new Comp Rows. The Comp Row(s) for the imported audio file(s) will be named “<filename.extension> (Imported)” where <filename.extension> is the name of the imported audio file with the appropriate extension.

Depending on if you selected one or several audio files, the following will happen:

• If you selected a single audio file, it will end up on the topmost Comp Row in the audio clip.

• If you selected several audio files, the first selected file will end up on the topmost Comp Row.

→ You can also drag one or several audio files from the Browser and drop it/them in the Comp Row area in the Comp Editor.

The audio files will then be imported to new separate Comp Rows in the Comp Editor. The horizontal divider indicates where the new Comp Row(s) will be inserted and the vertical divider indicates where the audio will begin. If Snap is active in the sequencer, this will be taken into consideration:

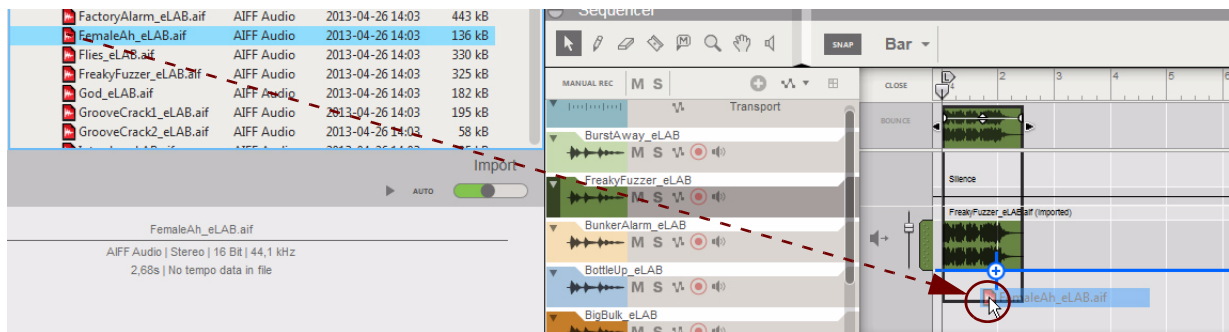

A + sign and a horizontal and a vertical divider indicate where in the Comp Row area the imported audio file(s) will be placed.

→ If you like, you could now edit the Audio Clip and comp the recordings on the different Comp Rows according to the description in **“Creating a comped audio clip”**.

# Exporting audio

You can export audio from Reason in some different ways. Besides exporting songs or parts of songs, it's also possible to export (bounce) audio from separate Mixer Channels, with or without the mixer settings. It's also possible to export (bounce) individual Audio Clips. You can choose a variety of sample rates for the exported/bounced audio, and also various audio file formats and resolutions.

In addition to the regular audio export and bounce functions, you can drop a song or a part of a song to your Propellerhead account, where you can play it back and also use it in other Propellerhead applications. You can also share your uploaded songs with others, see [“Drop to Propellerhead”](#).

## Exporting Songs or parts of Songs

There are two ways of exporting the mix of all active sequencer tracks in a song:

- **The “Export Song as Audio File...” on the File menu allows you to save the mix from the start of the song to the End Position Marker.**
- **The “Export Loop as Audio File...” on the File menu allows you to save the mix from the Left Locator to the Right Locator.**
- ! **When you export a song or a Loop, the signals for the exported audio file are taken from Outputs 1 and 2 of the Hardware Interface device. Any other used outputs on the Hardware Interface will be disregarded.**

Proceed as follows to export the mix of an entire song, or a loop section of a song:

1. **Make sure the End Position Marker is placed where you want the song to end or, if you want to export a Loop, make sure the Left and Right Locators are placed around the Loop you want to export.**
- ! **Make sure you place the End Marker (when exporting a Song) or Right Locator (when exporting a Loop) so that any sustaining sounds are allowed to decay to silence. Otherwise, there will be an abrupt “cut” in the end of the exported audio file. This is probably not what you want.**
2. **Select “Export Song as Audio File...” or “Export Loop as Audio File...” from the File menu.**  
The “Export Song as Audio File” or “Export Loop as Audio File” dialog appears.
3. **Choose location, File Name and File Format (AIFF or WAV) for the exported audio file at the bottom of the dialog and click “Save”:**

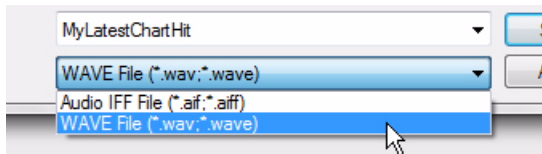

*Choose a file name and select file format.*

4. **Select “Sample Rate”, “Bit Depth” (resolution) and “Dither” in the “Export Audio Settings” dialog and click “OK”:**

If you are exporting at 16-bit Bit Depth you will have the option of applying Dither. Dither means that a type of noise is added to the digital signal to improve low level sound quality when exporting high resolution audio at a lower bit depth. Reason features a new, and very sophisticated, dithering algorithm with noise shaping.

→ Tick the “Dither” check box to improve the audio quality of exported audio at 16-bit resolution.

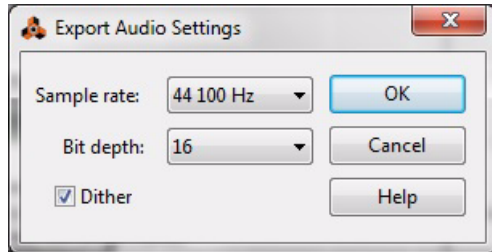

Select Sample Rate, Bit Depth and Dithering of the audio to be exported.

## About Tempo data in exported audio files

In addition to the audio data, tempo data is automatically included in the exported audio file. The tempo data contains information about the song Tempo and any Tempo Automation used in the song/loop. If you import such an audio file into another Reason song, it will automatically stretch to fit the current song tempo.

If the section to be exported contains audio for which high-quality stretching hasn't already been done, this will be calculated before the actual export happens. When Reason performs high-quality stretching, the CALC indicator on the Transport Panel shows a progress bar:



The CALC indicator indicates when Reason performs high-quality stretching of audio.

- **If high-quality stretching is still in progress when you export your audio file, the Export dialog will show a progress bar as well.**

As soon as the high-quality stretching is finished, the dialog will be closed.

# Bouncing Mixer Channels

Bouncing Mixer Channels basically means “recording” the audio outputs from Audio Track Channels and/or Mix Channels and then automatically creating separate audio files. The audio files can then be saved to disk or placed on new Audio Tracks in your song. If you choose to bounce to disk, the audio files will be automatically saved to disk as separate audio files. If you instead choose to bounce to new tracks, the bounced audio files will be automatically placed on new Audio Tracks in the sequencer.

The “bounce to disk” option is ideal if you want to export your sequencer tracks separately for further processing in external applications. The “bounce to track” option is great if you, for example, have instrument tracks with lots of resource consuming FX etc. and therefore want to render them into audio to free up DSP resources in your song.

You can choose to bounce the Mixer Channels, either throughout the entire song, or only between the Left and Right Locators. You can also choose to bounce with or without mixer settings.

To bounce Mixer Channels proceed as follows:

## 1. Select “Bounce Mixer Channels...” from the File menu.

The “Bounce Mixer Channels” dialog appears:

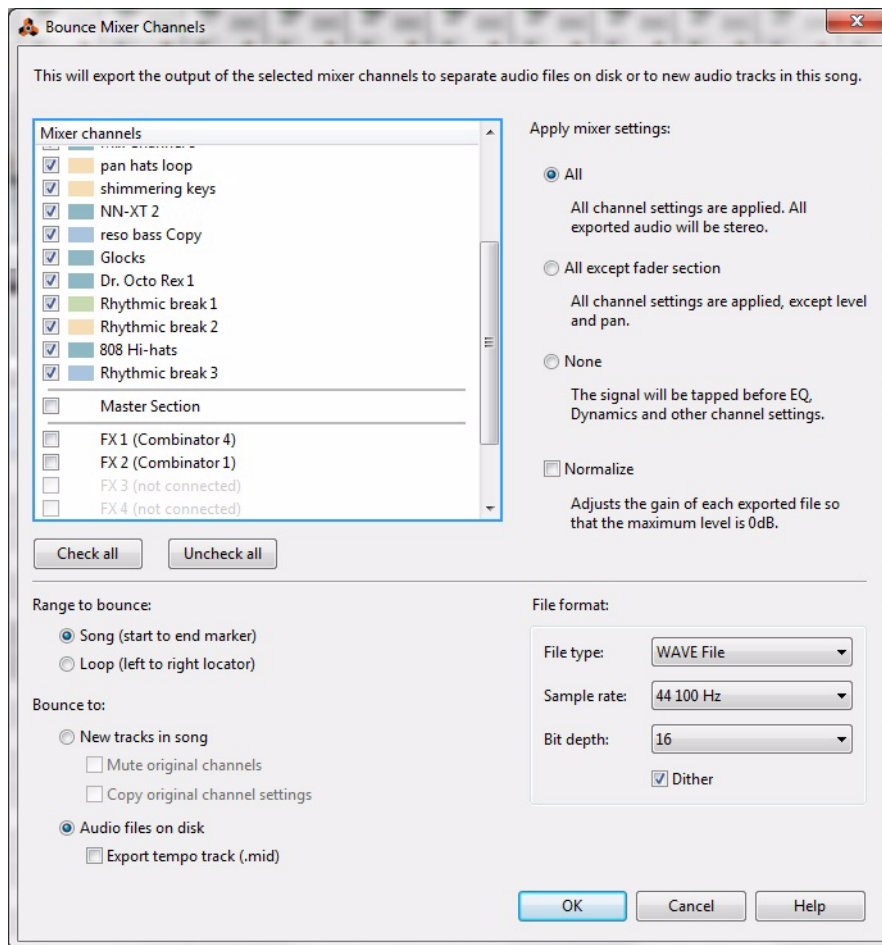

The “Bounce Mixer Channels” dialog.

When you open the “Bounce Mixer Channels” dialog, some channels in the Mixer Channels list might already be checked. This depends on what Mixer Channels (or their corresponding tracks or rack devices) were selected when you opened the dialog. The Master Section and FX Returns are never automatically checked when you open the dialog; you have to do that manually.



**2. Tick the check boxes for the Mixer Channels you want to bounce. Note that you can also bounce the Mixer Master Section and any FX Returns at the same time if you like.**

The Mixer Channels in the list appear in the order they are placed in the Main Mixer, i.e. not necessarily in numerical or chronological order. The color tags in the list correspond to the Channel Strip colors in the Main Mixer. The Master Section is always listed as "Master Section" in the list and the eight FX Returns are listed as "FX 1 Return (<name>)", where <name> is the FX name shown on the label in the Main Mixer. Selecting FX Returns makes it possible to bounce reverbs and other Send FX you might be using in your song. The FX signal is tapped after FX Return Level/Pan/Mute if "Apply Mixer Settings = All" (see below). Otherwise, the signals will be taken at the FX Return inputs.

→ **Click the "Check All" or "Uncheck All" buttons to activate or deactivate all checkboxes in one go.**

**3. Select what channel settings you want to use (or not use) by clicking one of the radio buttons in the "Apply Mixer Settings" section.**

→ **Select "All" to bounce the selected Mixer Channels with all its settings, including any Insert FX, Level and Pan.** Since the Pan parameter is included, mono Mixer Channels will be bounced as stereo audio files.

→ **Select "All except fader section" to bounce the selected Mixer Channels with all Mixer Channel settings, including any Insert FX, but excluding the Level, Pan, Stereo Width and Mute parameters of the Channel Strip.** Stereo Mixer Channels will be bounced as stereo audio files whereas mono Mixer Channels will be bounced as mono audio files. For the Master Section, this option means including Insert FX and the Master Compressor, but not the master fader.

→ **Select "None" to bounce the selected Mixer Channels before the Mixer Channel Strips, without applying any Mixer Channel parameters or Insert FX.**

Bounced files will be in stereo if there's any stereo material on the Audio Track (or, for a Mix Channel, if it's connected in stereo). Otherwise, the bounced audio files will be in mono.

**4. Tick the "Normalize" check box to adjust all bounced audio files so the maximum level is 0 dB.**

Normalizing is useful to get good levels when you proceed to use the bounced audio files in another application, or to avoid clipping.

**5. Select what range to bounce in the "Range to Bounce" section.**

→ **Select "Song" to bounce the entire song (from the beginning of the song to the End Marker).**

→ **Select "Loop" to bounce the section between the Left and Right Locators.**

**! Make sure you place the End Marker (when bouncing a Song) or Right Locator (when bouncing a Loop) so that any sustaining sounds are allowed to decay to silence. Otherwise, there will be an abrupt "cut" in the end of the bounced audio files.**

**6. Select destination for the bounced Mixer Channel(s) in the "Bounce to:" section.**

→ **Select “New Tracks in Song” to bounce the Mixer Channels to new Audio Tracks in the song.**

When “New Tracks in Song” is selected, the File Format settings in the dialog are disabled (as is the “Export Tempo Track (.MID)” setting). The audio will be rendered at the current song's sample rate (i.e. what you have previously set up in the hardware audio interface), at full 32-bit float resolution.

Clicking OK will create a new Audio Track for each selected Mixer Channel, create an Audio Clip on each of these Tracks and render the Mixer Channel audio as a recording on a Comp Row in the Audio Clip.

The new Audio Tracks will get the names and colors of their corresponding (bounced) Mixer Channels. The Audio Clips will get the same color but will not be labeled (named).

The new recordings (on the Comp Rows) will get the name of their source Mixer Channels + “(Bounced)”, e.g. “Picked Guitar (Bounced)” if the bounced Mixer Channel's name is “Picked Guitar”.

Selecting “Mute Original Channels” will mute all bounced Mixer Channels (those selected in the Mixer Channels list) after the bouncing. If there are automation lanes for their Mute buttons, their ON buttons will be turned off.

If you selected “None” in the “Apply mixer settings” section, you will be given the option to copy the original mixer channel settings to the destination channels. To do this, tick the “Copy original channel settings” box.

! **The “Mute Original Channels” setting does not affect the Master Section or the FX Returns.**

→ **Select “Audio Files on Disk” to bounce the Mixer Channels to audio files on disk.**

When “Audio Files on Disk” is selected, the “Mute Original Channels” option in the dialog is automatically disabled.

Choose File Type, Sample Rate, Bit Depth and any Dither in the “File Format” section.

Clicking OK will bring up a Save dialog which allows you to select a folder, or create a new folder. Clicking Save will then create one audio file per selected Mixer Channel and place in a sub-folder named “Bounced <song name>”. All audio files will have the file type, sample rate and bit depth as defined in the “File Format” section.

The audio files will get the name of the bounced Mixer Channels, plus the File Type extension. If several selected Mixer Channels have the same name, an incremental number (starting with “-01”) will be automatically added before the file extension.

The Song Tempo, and any Tempo Automation, is also included in the exported audio files. This means that if you import the audio files into another Reason Song document, they will automatically be stretched to the Song Tempo of that song.

If “Export Tempo Track (.MID)” is activated, the bounce function will also export a separate MIDI file containing the Song Tempo, and any Tempo Automation data. The MIDI file will have the name of the song, with the extension “.MID”. This MIDI file can then be imported to the tempo automation lane in another Reason Song document, or to the tempo track in another DAW, to automatically set the song tempo and control any tempo automation in the sequencer.

! **Note that the “Export Tempo Track” option is available only if you have selected “Audio Files on Disk” in the “Bounce to:” section and “Song” in the “Range to Bounce:” section.**

## Bouncing Audio Clips

### The “Bounce Clip to Disk” function

The “Bounce Clip to Disk” function becomes available when a single Audio Clip is selected (in Arrange Mode or Edit Mode). The function allows you to bounce single Audio Clips, after the Clip Level and Fades but without the Mixer Channel settings, to disk for further processing in an external application, for example. Do like this to bounce an audio clip to disk:

1. **Select an Audio Clip and choose “Bounce Clip to Disk...” from the Edit menu or context menu.**

The “Bounce Clip As Audio File” dialog appears. It looks the same, and has the same functionality, as the “Export Song as Audio File” and “Export Loop as Audio File” dialogs.

**2. Choose location, File Name and File Format (AIFF or WAV) for the bounced audio clip at the bottom of the dialog and click “Save”.**

(The default name in the dialog is the Clip name + extension, or (if there's no name label on the clip) the track name + extension.)

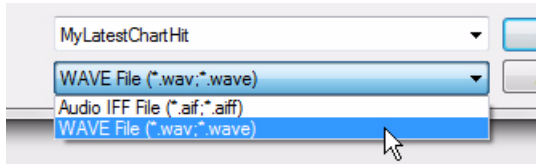

*Choose a file name and select file format.*

**3. Select “Sample Rate”, “Bit Depth” (resolution) and “Dither” in the “Export Audio Settings” dialog and click “OK”:**

If you are exporting at 16-bit Bit Depth you will have the option of applying Dither. Dither means that a type of noise is added to the digital signal to improve low level sound quality when exporting high resolution audio at a lower bit depth. Reason features a new, and very sophisticated, dithering algorithm with noise shaping.

**→ Tick the “Dither” check box to improve the audio quality of exported audio at 16-bit resolution.**

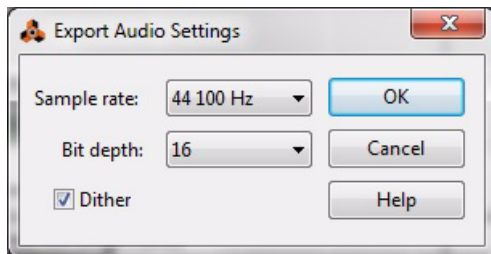

*Select Sample Rate, Bit Depth and Dithering of the audio clip to be bounced.*

The exported audio file will also contain tempo data as described in [“About Tempo data in exported audio files”](#).

## About the “Bounce Clip to New Sample” function

You can bounce an Audio Clip to a new Song Sample if you like. You could then edit the sample and load into a sampler device for playback.

See [“Bounce Clip\(s\) to New Sample\(s\)”](#) in the “Audio Editing in the Sequencer” chapter for more details.

## About the “Bounce Clip to New Recording” function

You can also bounce an Audio Clip to a new recording on an additional Comp Row in the Audio Clip. This is like a non-destructive “Flatten” operation. It will create a new recording from the clip output - ignoring Clip Level and Clip Fade In/Out settings. The recording will be placed on a new Comp Row at the top of the Comp Row list in the clip. The Audio Clip will then automatically switch to Single Mode.

See [“Bounce Clip\(s\) to New Recording\(s\)”](#) in the “Audio Editing in the Sequencer” chapter for more details.

## About the “Bounce Clip to REX Loop” function

A Single Take clip, which is open for inline editing, features the function “Bounce Clip to REX Loop” on the Edit and context menu. This allows you to generate a REX loop out of the Single Take audio clip. The REX loop can then be used in a Dr Octo Rex device in Reason and/or be exported to disk.

See [“Bounce Clip to REX Loop”](#) in the “Audio Editing in the Sequencer” chapter for more details.

## Drop to Propellerhead

A special audio export feature is the “Drop to Propellerhead” function. This lets you export a song, or part of a song (loop), in a proprietary Propellerhead format and automatically upload it to your Propellerhead account. The dropped (uploaded) audio can then be imported into other applications, such as the Propellerhead Take iOS app, and you can also share your exported files with others if you like.

Proceed as follows to export the mix of all active sequencer tracks of an entire song, or of a loop range of a song, and upload to Propellerhead:

! **The maximum allowed length of songs/loops dropped to Propellerhead is 10.00 minutes!**

1. **Make sure the End Position Marker is placed where you want the song to end or, if you want to drop a Loop, make sure the Left and Right Locators are placed around the Loop you want to export.**
- ! **Make sure you place the End Marker (when exporting a Song) so that any sustaining sounds are allowed to decay to silence. Otherwise, there will be an abrupt “cut” in the end of the uploaded audio file. This is probably not what you want.**

- ! **If you plan to use your exported file as a Beat in the Propellerhead Take iOS app, there are some important things to keep in mind:**

Any Tempo Automation and Time Signature Automation in the song/loop will be disregarded during import in Take. The file will open in Take, but without tempo indication (Free Tempo).

2. **Click the “Drop to Propellerhead” button to the right of the Audio Out meter on the transport panel (or select “Drop to Propellerhead” from the File menu):**



The “Drop to Propellerhead” dialog appears:

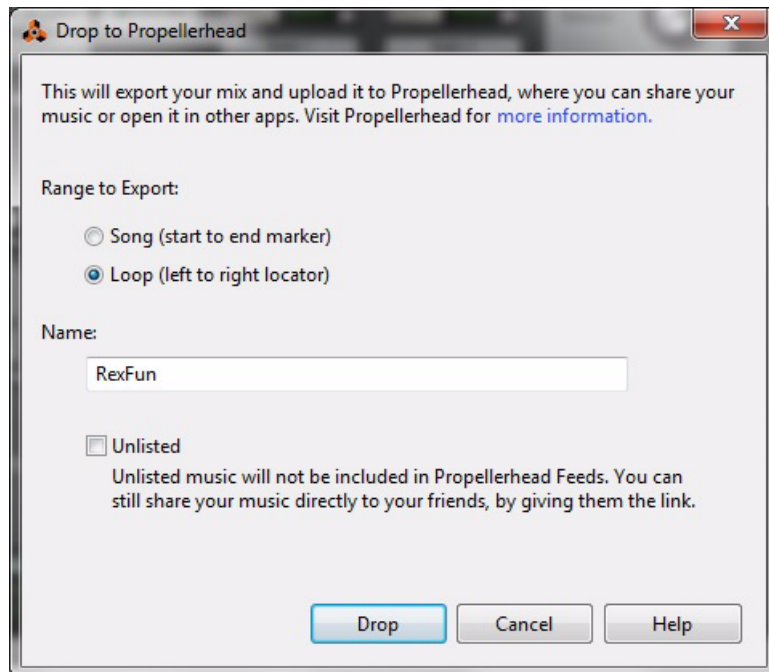

The “Drop to Propellerhead” dialog.

**3. Select what range to export in the “Range to Export” section.**

→ **Select “Song” to export the entire song, from the beginning of the song to the End Marker.**

→ **Select “Loop” to export the range between the Left and Right Locators.**

(If Loop mode is on in the sequencer, the “Range to Export” setting defaults to “Loop”.)

- **If you plan to use your exported Loop in other applications, for example as a backing Beat in the Propellerhead Take iOS app, you will want to make sure that your Loop loops smoothly. Therefore, always play back your Loop in Reason - with the sequencer in Loop mode - to make sure it sounds and loops the way you want.**

**4. If you like you can rename the file to be exported, by typing in a new name in the Name box.**

(The default Name is always the same as the Song name.)

**5. Select whether the exported file should be Unlisted or not.**

An Unlisted piece of music is only available to those who have the direct link to its page. This means that other users cannot find the piece by browsing or checking Feeds from Propellerhead. However, you can still share your Unlisted music with your friends by giving them the direct link.

**6. Click the Drop button to export and upload your Song/Loop to your Propellerhead account.**

If you are not already logged in to Propellerhead, the following dialog appears:

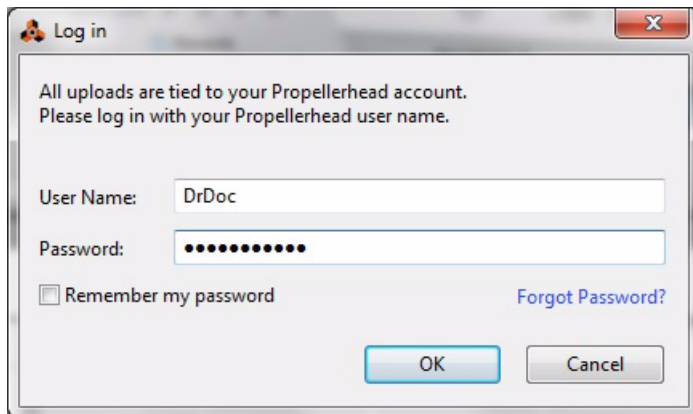

→ **Log in with your Propellerhead User Name and Password.**

The export begins and the file is uploaded to your Propellerhead account.

**! If you are running Reason using Internet Verification, you are already logged in and the file will be uploaded to your account without the Log in dialog.**

In addition to the audio data, tempo data is automatically included in the exported audio file. The tempo data contains information about the song Tempo and any Tempo Automation used in the song/loop.

When the upload has finished, your web browser automatically launches and shows the web page for your exported file on Propellerhead. On this page you can listen to your song, share the link to others etc.



# **Chapter 18**

## **Sampling**

# About this chapter

This chapter describes how you can sample, edit samples and manage your samples in your songs. For more information about the specific devices that can sample and play back samples, please refer to the “[NN-XT Sampler](#)”, “[NN-19 Sampler](#)”, “[Redrum Drum Computer](#)”, “[Kong Drum Designer](#)” and “[RV7000 Mk II Advanced Reverb](#)” chapters.

## Overview

The sampling feature allows you to sample external audio (or internally from the outputs of any device) and use in any of the devices that support sample files, i.e. NN-XT, NN-19, Redrum, Kong and RV7000 Mk II.

## One-click sampling

The sampling workflow has been designed to be as quick and easy as possible, so you don't lose any inspiration. Regardless which device you use when sampling - be it the NN-XT, NN-19, Redrum, Kong or RV7000 Mk II - sampling can be instantly accessed by simply clicking, or by clicking and holding the Sampling button(s) on these devices:



Sampling buttons on NN-XT, NN19, Redrum and Kong respectively.

See “[Sampling procedure](#)” for more details on how to sample.

## The Edit Sample window

All sampling parameters and functions are controlled from one single window - the Edit Sample window. This window is used when you're editing samples in any of the devices described above, See “[Editing samples](#)” for more details.

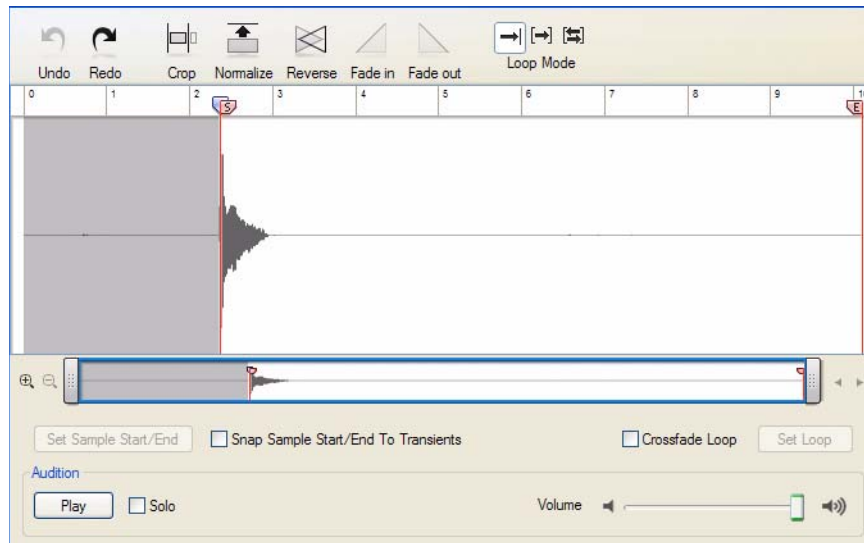

The Edit Sample window with a sample.



## About sample format, rate and resolution

Whenever you sample in Reason, the resulting audio files are stored in WAV format. The sample rate is determined by the settings on the Audio tab in Preferences (see “Audio settings”). The resolution (bit depth) is defined in the setup application for your specific audio hardware (consult the manual for your audio hardware for information). Actually, Reason is totally agnostic about what sample rate and resolution you use. If you like, you can change audio settings at any time without affecting the pitch, playback speed etc. of your samples. What you have once sampled will always sound the same, regardless of the current audio settings!

## General sampling functions

### Setting up for sampling

If you want to sample external audio, e.g. from a mic or an instrument connected to the audio hardware on your computer, make sure you have set up the desired audio input(s) on the Audio tab in Preferences, see “Active input and output channels”. Available audio inputs are indicated with yellow or green LEDs on the Hardware Interface in the rack:



### Selecting audio input source(s)

To set up for sampling, you first need to make some connections on the Hardware Interface:

1. **Navigate to the Hardware Interface and press [Tab] to flip the rack around.**
2. **Patch cables to the Sampling Inputs as follows:**
  - To sample external audio, connect the desired Audio Input connector(s) to the Sampling Input connector(s) to the left on the rear of the Hardware Interface.
  - To sample the audio of a device in the rack, connect cables from the audio output(s) of the device to the Sampling Input connector(s) on the Hardware Interface.
  - To sample in stereo, connect to both the Left and Right Sampling Input connectors.
  - To sample in mono, connect only to the Left or Right Sampling Input connector.



*Audio Inputs 1&2 connected to Sampling Inputs L&R for sampling in stereo.*

## Setting audio input level

Once you have made the desired connections to the Sampling Input(s) on the Hardware Interface, it's important to check the audio input level to avoid clipping. If you are going to sample external audio via the audio hardware of your computer, you have to adjust the level at the source, i.e. on the pre-amp of the audio hardware (or connected instrument). A good suggestion is to use the Big Meter on the Hardware Interface to be able to monitor the input level(s) more easily.

- **Adjust the level at the source and make sure the level doesn't exceed 0 dB to avoid clipping.**

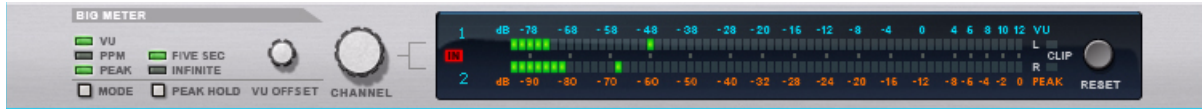

- **If you sample internally, from the output(s) of a device in the rack, adjust the Output Level on the source device and check the levels with the Sampling Inputs selected on the Big Meter:**

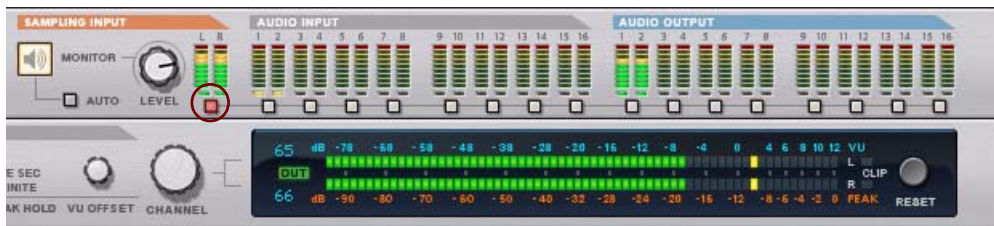

## Monitoring and Monitor Level

To the left on the Hardware Interface are two buttons and one knob for monitoring the signals on the Sampling Inputs:

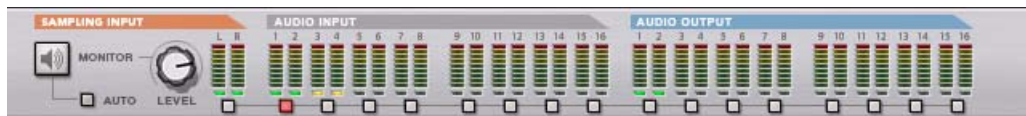

- **Click the Monitor button to activate monitoring of the signals present at the Sampling Inputs.**  
Monitoring will always be active, regardless of if you sample or not.
- **Click the Auto button to activate monitoring only during sampling.**  
Monitoring will only be active during the actual sampling. When you don't sample, monitoring will be off.
- **Turn the Monitor knob to adjust the monitor signal level.**
- ! **The Monitor Level knob does not affect the level of the audio to be sampled - only the monitored signal.**

# Sampling

## The Sample buttons

The NN-XT, NN19, Redrum, Kong and RV7000 Mk II devices feature one or several Sample buttons. The Sample buttons are located on the devices as follows:



*Sampling buttons on NN-XT, NN19, Redrum and Kong respectively.*

## Sampling procedure

1. **Make sure you have made the necessary connections and set the levels according to the descriptions in “Setting up for sampling”.**
2. **Click the Sample button on the device you want to sample to.**
  - **Alternatively, click and hold the Sample button depressed for as long as you want to sample.**  
When you use the “click and hold” method, sampling will be automatically terminated as soon as you release the mouse button. The sample will then end up in the device and in the Song Samples location in the Browser.
- ! **If you’re sampling into a Redrum, make sure you click/hold the Sample button for the desired drum channel.**  
A waveform display shows up with a moving “play head”:



3. **Start playing or singing what you want to sample.**  
As soon as any audio is present on the Sampling Inputs on the Hardware Interface, the waveform display will indicate this by drawing a wave.
- ! **The buffer size for sampled audio is 30 seconds. After 30 seconds, the play head will start over again from the beginning and start erasing any previously sampled audio.**

→ If you want to restart the sampling manually, click the Restart Sampling button:

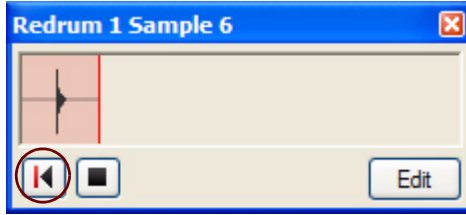

The "Restart Sampling" button.

This will erase any sampled audio and force the play head to restart from the beginning.

! **Note that you cannot restart sampling this way if you use the "click and hold" sampling method.**

4. **When you're satisfied with your recording, click the Stop Sampling button in the waveform display.**

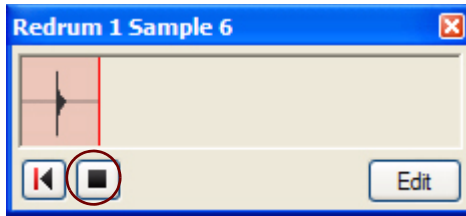

The "Stop Sampling" button.

The waveform display closes and the sample automatically ends up in the device, where you can play it back instantly:



By default, the sample is named "Sample 'n'" where 'n' is a serial number. As you will notice, any silence preceding the actual audio in the sample will be automatically disregarded. The entire sample is preserved, but this is done so you won't have to edit the sample start before playback.

Besides ending up in the device, the sample is also placed under the corresponding device icon in the Assigned Samples folder in the Song Samples location in the Browser:

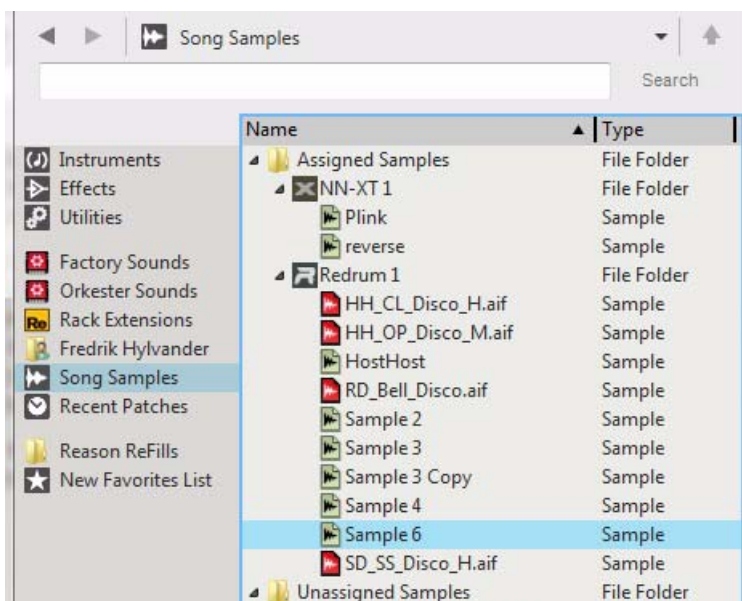

Here, all samples you use in your song are listed (see [“The Song Samples location”](#)). Here is also where you can open samples for editing (see [“Editing samples”](#)).

## The Song Samples location

The Song Samples location in the Browser is where all samples in your song are listed and can be accessed for preview and editing purposes. Besides your own samples, all Factory samples and any ReFills samples used in the song are also accessible for previewing and editing!

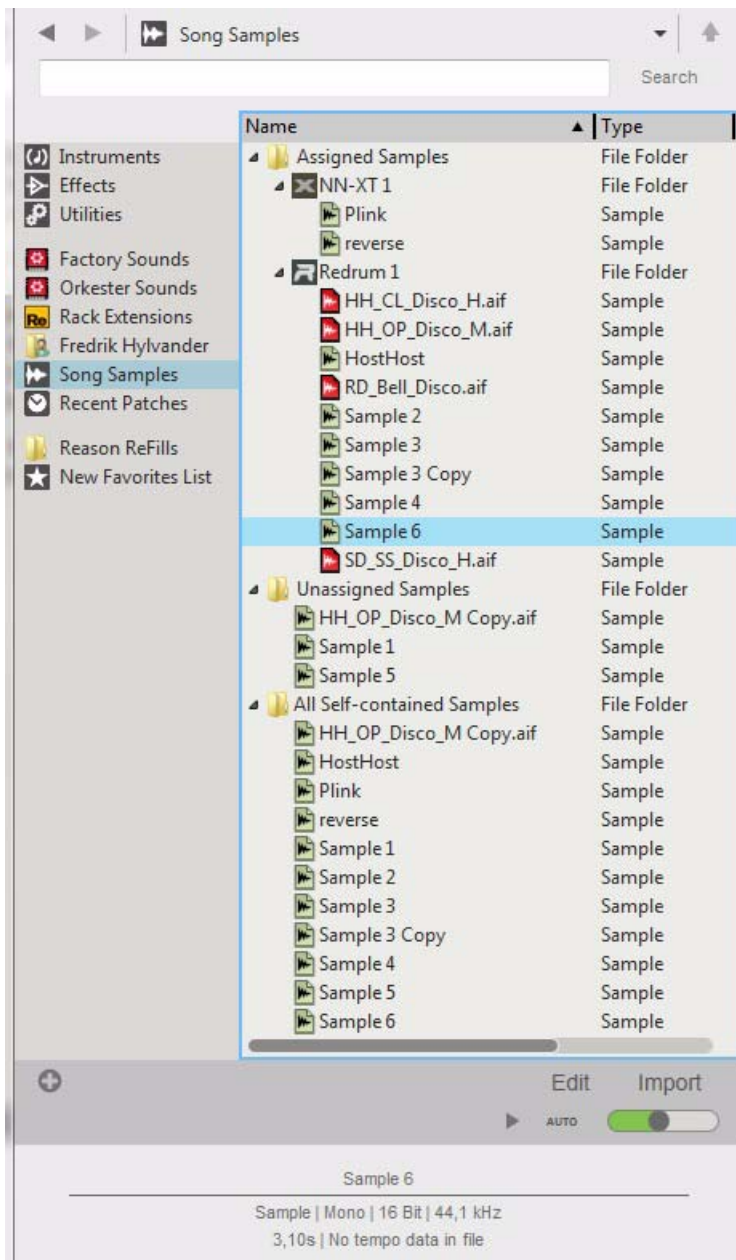

The Song Samples location in the Browser.

The Song Samples location in the Browser contains the following items:

- **Assigned Samples folder**  
Here, all samples that are assigned to devices in the song are listed. All devices that contain assigned samples are listed as “sub-folders”. Each device “sub-folder” shows the samples currently assigned to it. See [“Assigned Samples”](#) for more details.
- **Unassigned Samples folder**  
If you remove a sound you have sampled from a device, the sound is automatically moved from the Assigned Samples folder to the Unassigned Samples folder. From here you can load the sample into other devices if you like. See [“Unassigned Samples”](#) for more details.
- **All Self-contained Samples folder**  
All sounds you have sampled yourself, plus any duplicated samples from the Factory Soundbank and/or ReFills, automatically becomes self-contained and are always stored with the song. These samples are listed in the All Self-contained Samples folder. See [“About self-contained samples”](#) for more details.
- **Edit button**  
Click the Edit button to open the selected sample for editing in the Edit Sample window (see [“The Edit Sample window”](#)).
- **Import button**  
Click this button to import the selected sample(s) to audio tracks in the sequencer.
- **Play and Auto buttons**  
To audition a sample, select it in the Browser list and click the Play button. If you click the Auto button, simply selecting a sample in the list will automatically play it back.
- **Volume slider**  
Adjust the preview volume of the sample with the slider. This does not affect the samples original volume.

The context menu of a selected sample contains the following functions:

- **Edit Sample**  
Select this to open the sample for editing in the Edit Sample window (see [“The Edit Sample window”](#)). If several samples are selected, this item is grayed out.
- **Duplicate Sample(s)**  
Select this to create a duplicate of the selected sample. The duplicated sample is placed in the All Self-contained Samples and Unassigned Samples folders. Several selected samples can be duplicated in one go. See [“Duplicating samples”](#) for more details.
- **Export Sample(s)**  
Select this to export the selected sample to disk. A dialog appears where you can select file format. Note that it is not possible to export samples from the Factory Soundbank or from ReFills. Several selected samples can be exported in one go. See [“Exporting samples”](#) for more details.
- **Delete Sample(s)**  
Select this to permanently delete the selected sample(s) from the song. Note that samples from the Factory Soundbank and from ReFills will not be deleted from their original locations - only from the song document. Several selected samples can be deleted in one go. See [“Deleting samples from a song”](#) for more details. Any samples you have recorded yourself will be permanently erased unless you have previously exported them to disk (see [“Export Sample\(s\)”](#) below).

# Editing samples

## The Edit Sample window

Any sample present in the All Self-contained Samples folder in the Song Samples location in the Browser can be edited.

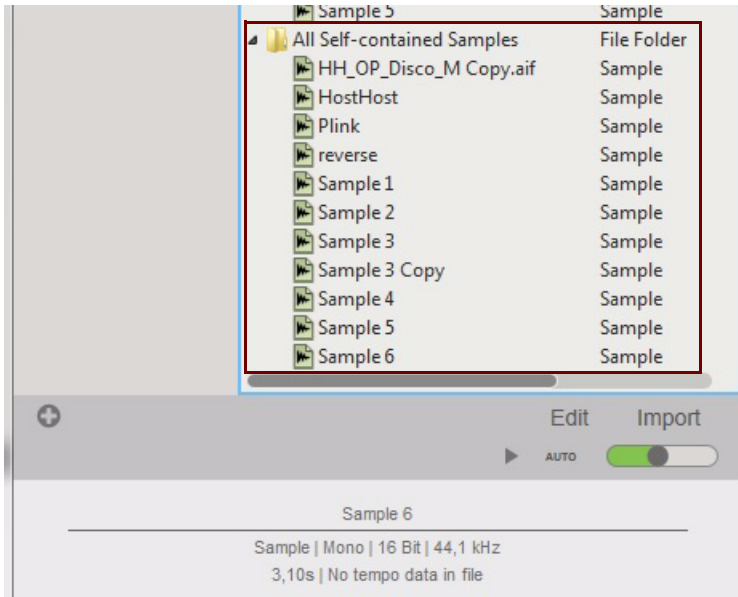

→ Select a sample in the Browser list and click the Edit button to open the sample in the Edit Sample window:

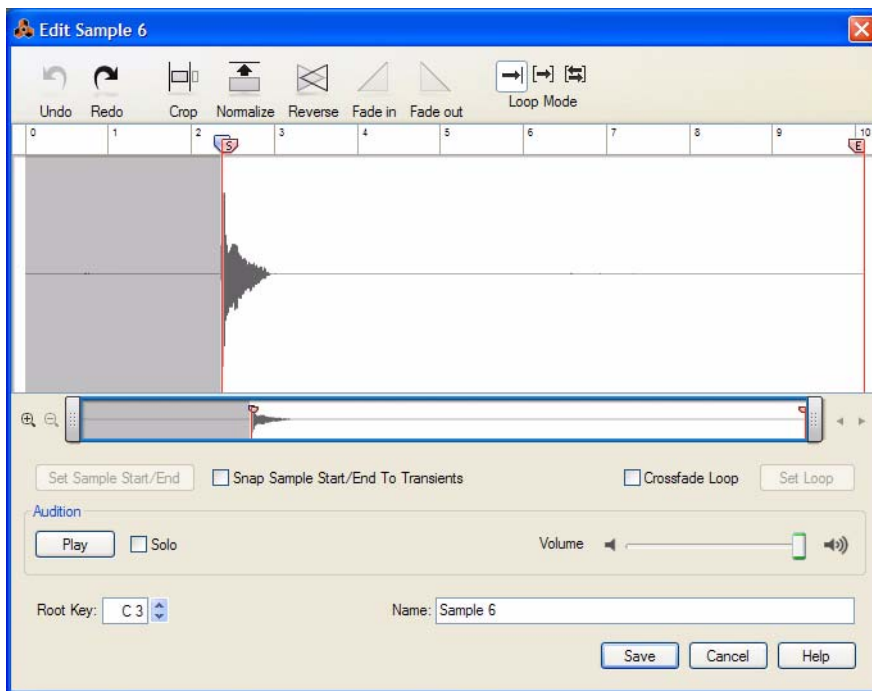

The Edit Sample window with an open sample.



The Edit Sample window can be resized in all directions by clicking and dragging the window frame. If you resize the window vertically, the displayed waveform will be resized vertically as well.

- **Undo and Redo buttons**

The Undo and Redo buttons work like the regular undo and redo functions in the main window menu, but these are used locally only for the Sample Edit window. The number of Undo and Redo steps in the Sample Edit window are limited to 10. Once you have clicked the Save button, you can still undo the entire sample editing procedure by using the Undo function in the main window.

- **Crop button**

Click the Crop button to crop the sample so that only the content between the Start (S) and End (E) locators is preserved. The rest of the sample will be permanently deleted. See [“Cropping samples”](#) for more info.

- **Normalize button**

Click the Normalize button to amplify the entire sample so that the loudest peak touches 0 dB. Note that the entire sample is normalized, regardless of any locator settings. See [“Normalizing samples”](#) for more info.

- **Reverse button**

Click the Reverse button to reverse (play backward) the entire sample. Note that the entire sample is reversed, regardless of any locator settings. See [“Reversing samples”](#) for more info.

- **Fade In and Fade Out buttons**

The Fade In and Fade Out buttons can be used to apply a fade in or fade out of the sample volume. See [“Fading in/out samples”](#) for more info.

- **Loop Mode buttons**

Click one of the Loop Mode buttons to select loop type. The default (leftmost) setting is “no loop”. Then follow “Loop Forward” and “Loop Forward + Backward”. See [“Looping samples”](#) for more info.

- **Waveform pane**

Here, the currently open sample is displayed as one (mono) or two (stereo) waveforms. The Start (S) and End (E) locators are also displayed. By default the Start locator is placed where the audio begins in the sample. This means that if you have started sampling before there were any audio present, the playback will automatically start where the audio begins. This way you won't have to manually move the Start locator in most situations.

- **Waveform Navigator**

Below the waveform pane is the horizontal Waveform Navigator. This can be operated in the same way as the Song Navigator in the sequencer (see [“Scrolling with the Navigators and scrollbars”](#), [“Zooming horizontally in the Sequencer”](#) and [“Scrolling and zooming using a wheel mouse”](#)).

- **Set Sample Start/End button**

Set the desired sample playback region by clicking and dragging on the waveform pane. Then, click the Set Sample Start/End button to automatically place the Start and End locators at the beginning and end of the sample region. See [“The Set Start/End function”](#) for more info.

- **Snap Sample Start/End To Transients button**

Click the Snap Sample Start/End To Transients button to make the Start and End locators snap to suitable transients in the sample as you move the locators. This makes it easier to find appropriate start and end locations for the sample playback.

- **Crossfade Loop checkbox**

Tick the Crossfade Loop box to introduce a crossfade in the loop. Crossfade is useful to even out any clicks in the loop points, especially for sounds with fairly even volume throughout the loop region. See [“The Crossfade Loop function”](#) for more info.

- **Set Loop button**

Set the desired loop region by clicking and dragging on the waveform pane. Then, click the Set Loop button to automatically place the Left and Right Loop locators at the beginning and end of the loop region. See [“The Set Loop function”](#) for more info.

- **Play button, Solo checkbox and Volume slider**

Click the Play button to play back the sample from the current position of the play head until the end of the sample. As soon as playback is started the button switches to display Stop instead, giving you the option of stopping playback. This is especially useful if your sample is looped. As an alternative to clicking the Play/Stop button you can press [Spacebar] to toggle between Play and Stop.

Tick the Solo checkbox to solo sample playback. This is useful if your song is playing in the background and you only want to listen to the sample.

Adjust the sample playback volume with the Volume slider to the right.

- **Root Key**

Set the sample Root Key (pitch) by clicking the spin controls, or by entering the desired note value in the display. If you know what note your sample is, select that note here. When you open the sample in a sampler device, the device will automatically transpose the sample correctly across the keyboard.

- **Name**

Type in desired name for your sample. Note that this will overwrite the original name of the sample in the Song Samples list in the Tool Window once you click Save. See [“Renaming samples”](#) for more info.

- **Save and Cancel buttons**

Click Save to save your sample. The sample will appear in the Song Samples location in the Browser. See [“Saving edited samples”](#) for more info.

Click Cancel to exit the Edit Sample window and discard from any edits you’ve made in the current sample.

## Setting Sample Start and End

1. **Open the sample by selecting it in the Browser list and clicking the Edit button - or select “Edit Sample” from the context menu.**

The sample opens in the Edit Sample window.

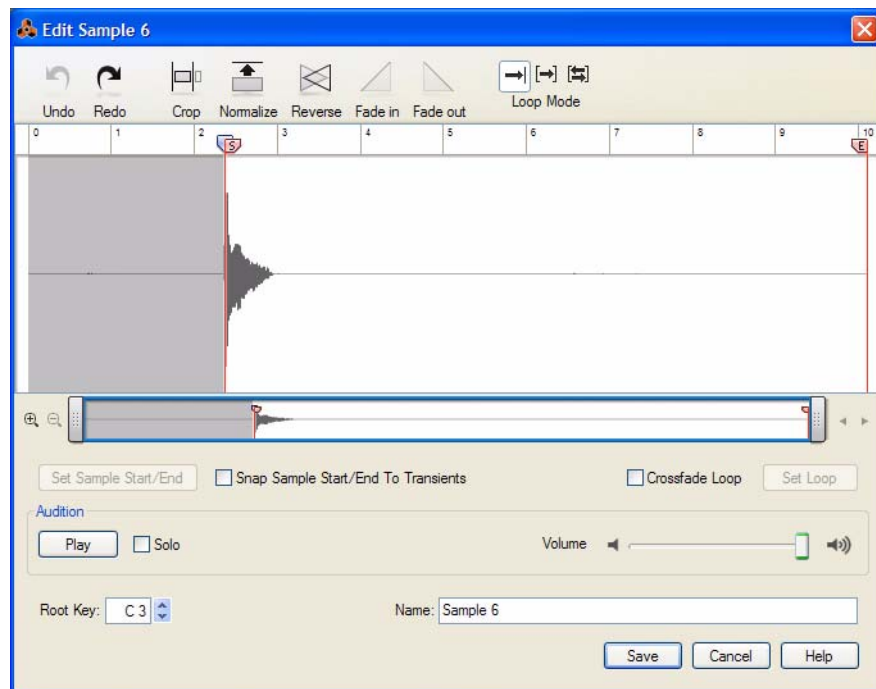

If you have recorded the sample yourself in Reason, the Start (S) locator has been automatically placed at the first significant transient in the sound. The play head is also automatically placed at the Start locator.

2. If necessary, adjust the Start locator by clicking and dragging it back or forth in the Edit Sample window ruler. Play back the sample by clicking the Play button, or by pressing the [Spacebar].
  - To make it easier to fine adjust the locators, it could be wise to magnify the waveform pane horizontally using the Waveform Navigator. The Waveform Navigator works exactly as the Song Navigator in the Sequencer - see "Zooming horizontally in the Sequencer" and "Scrolling and zooming using a wheel mouse".
  - > Tick the "Snap Sample Start/End To Transients" check box if you want the locators to snap to significant transients in the sample.
3. Adjust the End locator by clicking and dragging it back or forth in the Edit Sample window ruler.

## The Set Start/End function

Another way of defining a sample's start and end positions is by using the Set Start/End function:

1. Set the desired sample playback zone by clicking and dragging on the waveform pane.

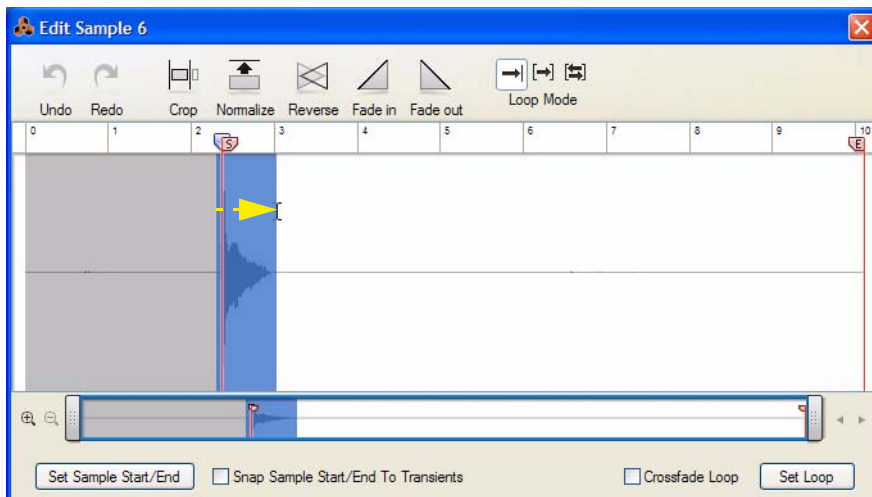

The defined zone is highlighted in blue color.

2. Click the Set Sample Start/End button.

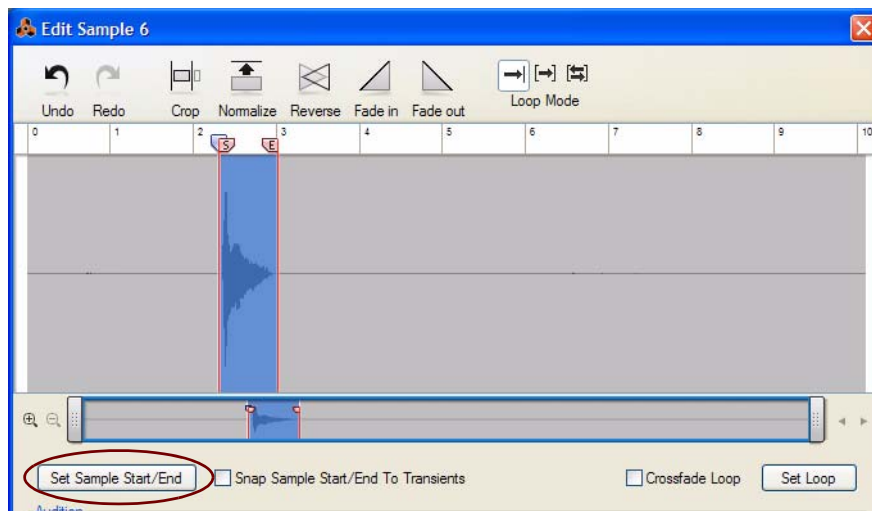

The Start and End locators are automatically placed at the beginning and end of the defined playback zone.

3. Click anywhere on the Waveform pane to remove the highlight.

## Cropping samples

Cropping a sample means deleting parts you don't want to keep, e.g. any silence in the beginning and/or in the end of a sample. The Crop function in the Edit Sample window deletes everything except what's in between the Start and End locators, or everything outside any highlighted part of the sample. To crop a sample, proceed as follows:

1. **Set the Start and End locators where you want them - see “Setting Sample Start and End”.**

Alternatively, click and drag in the Edit Sample window to highlight the section you want to keep.

2. **Click the Crop button in the Edit Sample window.**

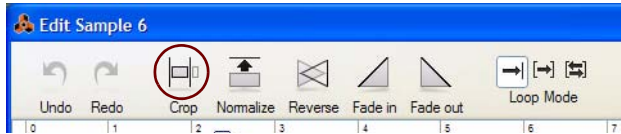

- **If you highlighted a section by clicking and dragging in the Edit Sample window, everything except the highlighted part gets permanently deleted.**
- **If you didn't highlight a section of the sample, everything before the Start locator and after the End locator gets permanently deleted.**

## Normalizing samples

Normalizing means amplifying the volume of the sample so that the loudest peak in the sound touches 0 dB. The Normalize function normalizes either the entire sample, or the highlighted part of the sample.

1. **Click and drag in the Edit Sample window to highlight the part of the sample you want to normalize.**

To normalize the entire sample, you don't have to do anything.

2. **Click the Normalize button in the Edit Sample window.**

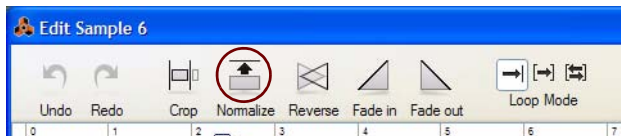

- **If you highlighted a section of the sample, the highlighted part gets normalized.**
- **If you didn't highlight a section of the sample, the entire sample gets normalized regardless of any Locator settings.**

Since the entire sample is normalized, this means that any noise present in the sound will also be amplified.

After the Normalize operation, the waveform is redrawn with the new volume values.

- ! **Note that normalizing a sample that already use the full headroom (touches 0 dB) won't have any effect.**

## Reversing samples

Reversing a sample means playing it backwards, from the end to the start. The Reverse function reverses either the entire sample, or the highlighted part of the sample.

1. **Click and drag in the Edit Sample window to highlight the part of the sample you want to reverse.**

To reverse the entire sample, you don't have to do anything.

2. **Click the Reverse button in the Edit Sample window.**

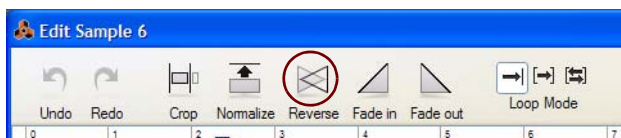

- If you highlighted a section of the sample, the highlighted part gets reversed.
  - If you didn't highlight a section of the sample, the entire sample gets reversed regardless of any Locator settings.
- After the Reverse operation, the waveform is redrawn with the reversed shape.

## Fading in/out samples

Using short fades is useful if you want to remove clicks or pops in the beginning and/or end of the sample. You can also create longer fades to make a sound fade in and/or out nice and smoothly.

1. Set the desired Fade In (or Fade Out) zone by clicking and dragging on the waveform pane.

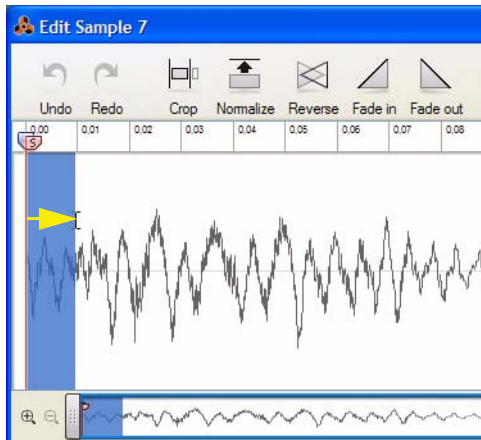

The defined zone is highlighted in blue color.

2. Click the Fade In (or Fade Out) button.

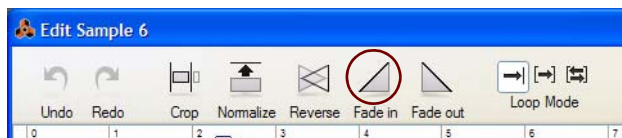

Clicking the Fade In button creates a fade in from complete silence at the beginning of the highlighted zone to the current volume at the end of the highlighted zone:

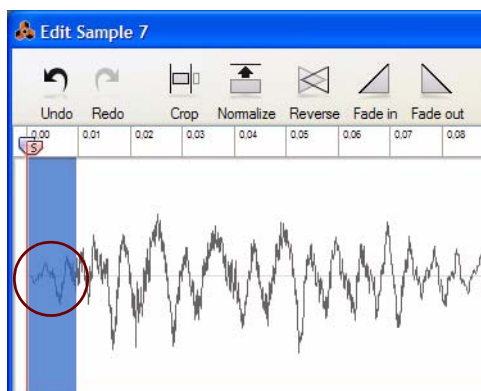

Clicking the Fade Out button creates a fade out from the current volume at the beginning of the highlighted zone to complete silence at the end of the zone.

After the Fade operation, the waveform is redrawn with the new volume values.

3. Click anywhere on the Waveform pane to remove the highlight.

## Looping samples

Looping a sample means playing back the sample from the start and then playing back a defined zone in the sample over and over again (usually for as long as a key is depressed on the MIDI master keyboard). In practice, looping samples can be used to create “longer” sounds out of shorter ones. For example, if you have a flute sample you may want to loop the middle part of it so that you could make the sound sustain as for long as you like.

There are two different loop modes available in the Edit Sample window (besides the default non-loop mode):

- **Loop Forward**

In Loop Forward mode the sample is played back from the Start locator to the Right Loop locator, then playback starts over from the Left Loop locator and continues to the Right Loop locator over and over again.

- **Loop Forward + Backward**

In Loop Forward + Backward mode the sample is played back from the Start locator to the Right Loop locator, then the playback is reversed from the Right Loop locator to the Left Loop locator and then forward again to the Right Loop locator over and over again.

## Adjusting the Loop locators

### 1. Click the Loop Forward or Loop Forward + Backward button.

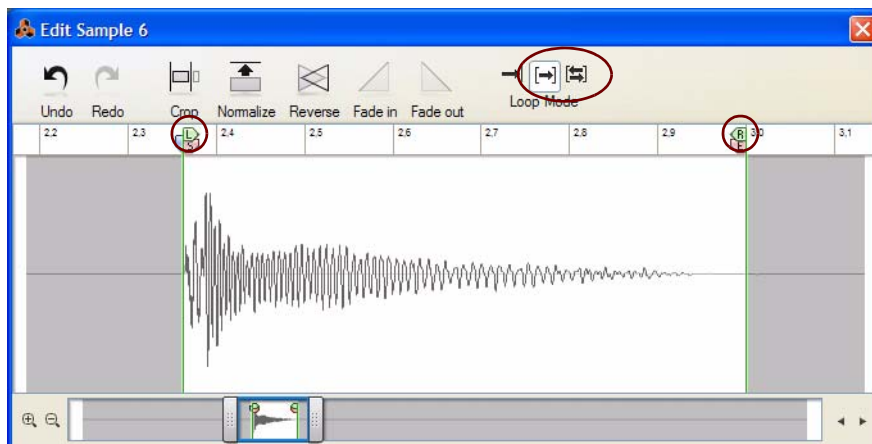

The Left (L) and Right (R) Loop locators appear on the Waveform pane.

### 2. Play back the sample and adjust the Loop locators to your liking.

If necessary, zoom in horizontally to more easily find suitable loop positions.

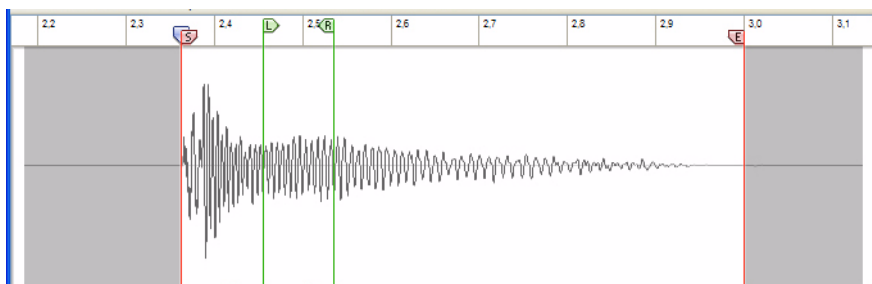

→ To make loops sound smoother, try using crossfades as described in [“The Crossfade Loop function”](#).

## The Set Loop function

Another way of defining a sample's loop positions is by using the Set Loop function:

1. **Set the desired loop zone by clicking and dragging on the waveform pane.**

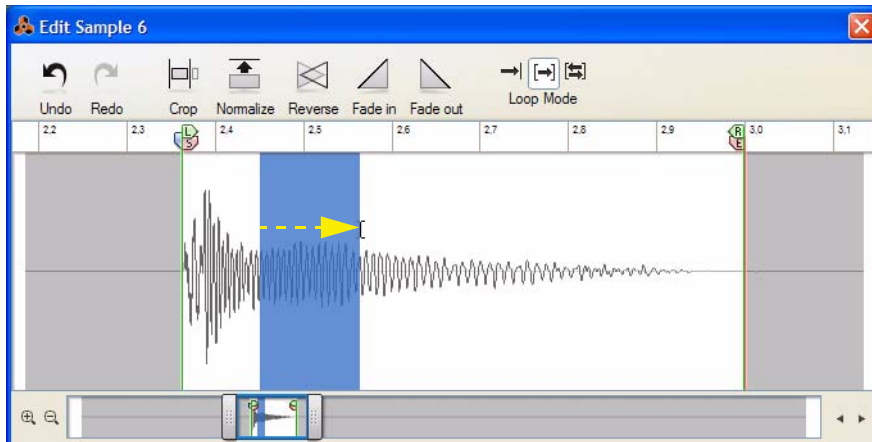

The defined zone is highlighted in blue color.

2. **Click the Set Loop button.**

The Left and Right Loop locators are automatically placed at the beginning and end of the defined zone.

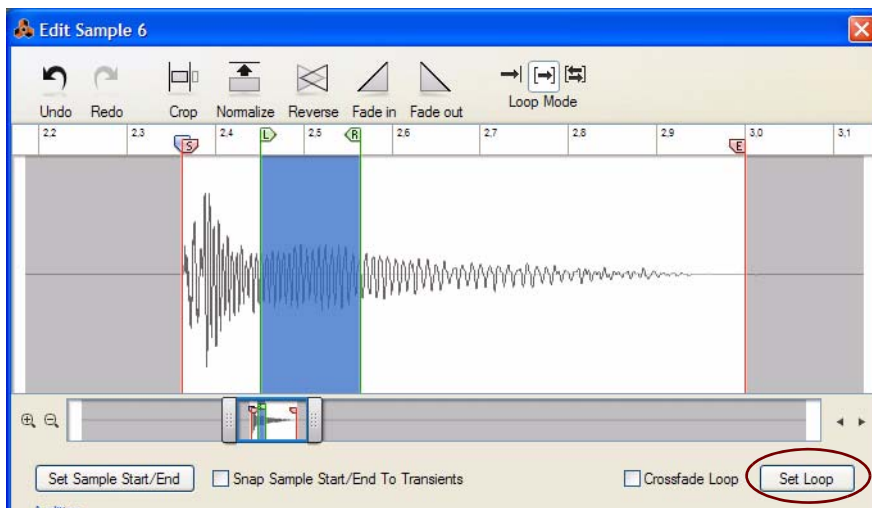

3. **Click anywhere on the Waveform pane to remove the highlight.**

→ To make loops sound smoother, try using crossfades as described in [“The Crossfade Loop function”](#).

## The Crossfade Loop function

Crossfades are useful for evening out clicks or transients at the loop points, especially in sounds with fairly constant volume throughout the loop zone. The Crossfade Loop function creates smooth volume crossfade around the Loop Locators.

→ **Tick the Crossfade Loop box to automatically introduce a crossfade in the loop.**

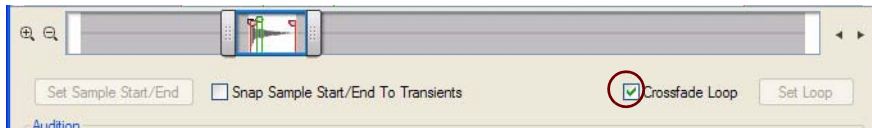

• **When the Crossfade Loop function is active, moving the Left and/or Right Loop Locators will force them to automatically “snap” to suitable loop positions. If you move the Left Loop Locator, the Right Loop Locator will automatically self-adjust to a suitable loop position.**

This way you will quickly reach a good result.

→ **Experiment by alternating the Loop Modes between Loop Forward and Loop Forward + Backward. Just changing Loop Mode can make the loop transitions much smoother in many situations.**

→ **A general tip when trying to create a smooth loop is to locate the loop zone where the volume and timbre is fairly constant over time. Big changes in volume and/or timbre in the loop zone will often result in quite pronounced or strange “pulsating” loops. Also, very short loop zones often tend to sound unnatural and “static”.**

## Saving edited samples

→ **Click the Save button in the Edit Sample Window to save your edited sample.**

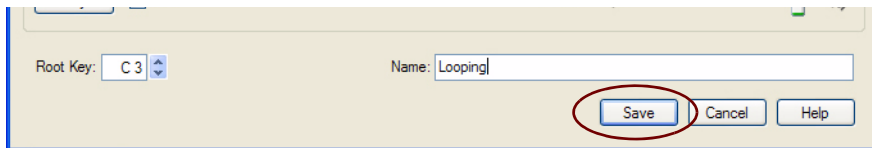

The sample is saved, complete with all the edits you have made in the Edit Sample Window (Start, End, Loop settings, Name etc.) The sample will appear in the Song Samples location in the Browser, with the new name if this has been changed.

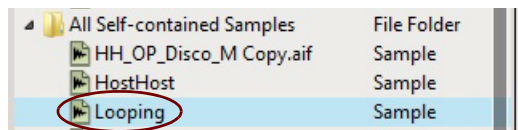

! **If you have opened and edited a ReFill sample, a copy of this sample (including any edits) will be saved with its original name in the All Self-contained Samples folder.**

## Renaming samples

1. **Type in the desired name of your sample in the Name field in the Edit Sample Window.**



2. **Click the Save button to save the sample with the new name.**

! **Note that saving a sample under a different name will simply replace the current name - it will not create a copy of the original sample!**



# Sample management

## About Assigned and Unassigned samples

### Assigned Samples

Samples can be assigned to devices that support sample playback, such as the NN-XT, NN19, Redrum and Kong. Samples that are assigned to a device can be found in the Assigned Samples folder in the Song Samples location in the Browser:

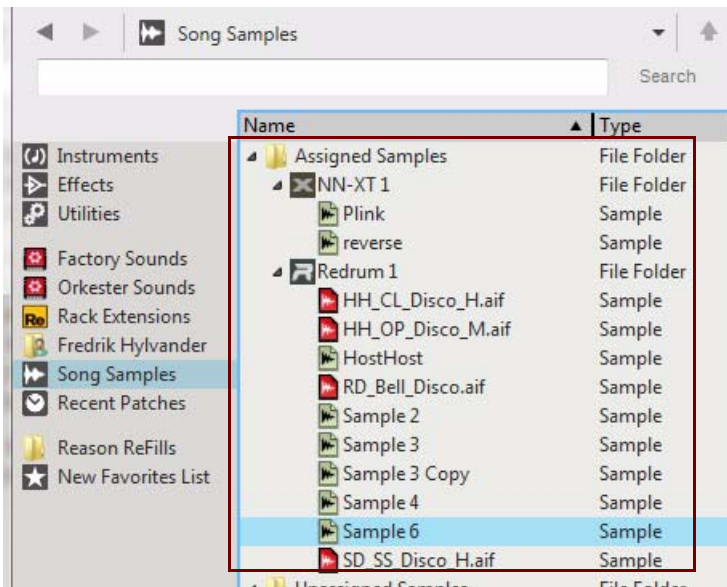

The Assigned Samples folder can contain various sub folders, one for each sampler device used in the current song. The song in the picture above contains two sampler devices; the “NN-XT 1” and the “Redrum 1”. The instrument folders can be unfolded to display their current sample contents. Sounds you have sampled yourself as well as samples from the Factory Soundbank and from ReFills are displayed with icons.

### Unassigned Samples

Samples that have been removed from a sampler device and have not (yet) been assigned to another sampler device are displayed in the Unassigned Samples folder:

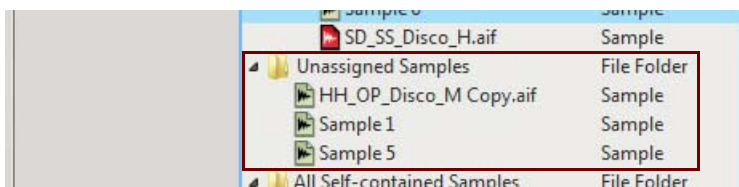

Unassigned samples can be assigned to any sampler device by simply loading them into a sampler device - see [“Loading samples into a device”](#).

## Saving samples in a song

When you have recorded a sample, by clicking a Sample button on a sampler device, the sample is automatically stored in the All Self-contained Samples folder in the Song Samples location in the Browser:

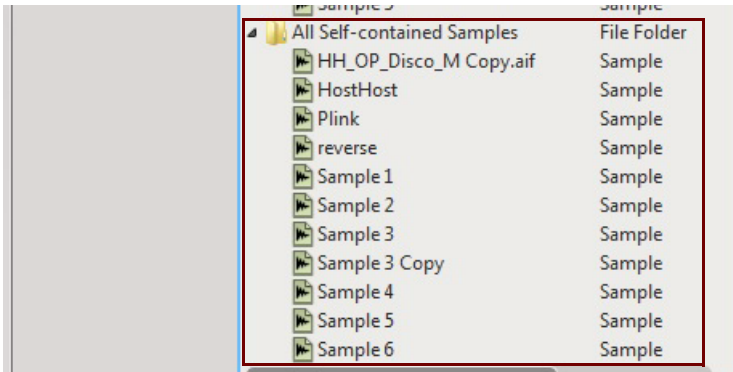

The samples you have recorded are automatically named “Sample ‘n’” where ‘n’ is a serial number.

You can rename a sample by selecting it in the All Self-contained Samples folder, clicking the Edit button, then renaming it in the Edit Sample Window and then clicking the Save button.

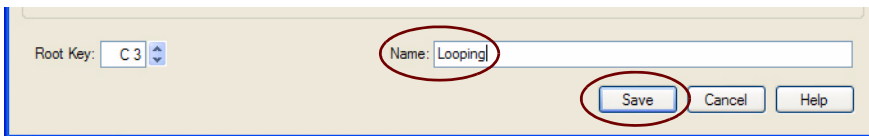

As soon as you save your song, all samples you have recorded will be automatically saved as self-contained samples in the song document. This way you don't have to keep track of any “loose” samples on your computer.

## Deleting samples from a song

It's only possible to delete samples you have recorded yourself in a Reason song, i.e. samples that are located in the All Self-contained Samples folder in the Browser. Samples from the Factory Soundbank and from ReFills cannot be deleted because they are contained in ReFills.

- **To delete a sample in the All Self-contained Samples folder, select it and select “Delete Sample(s)” from the context menu.**
- ! **Since the selected sample also exists, either in the Assigned Samples folder or Unassigned Samples folder, it will be deleted from there as well. Similarly, if you select and delete a non-Factory Soundbank/ReFill sample from the Assigned Samples folder or Unassigned Samples folder, it will be deleted from the All Self-contained Samples folder as well.**

# Loading samples into a device

To load samples into a sampler device (NN-XT, NN19, Redrum, Kong and RV7000 Mk II) proceed as follows:

## 1. Click on a Browse Sample button on the device.



Browse Sample buttons on NN-XT, NN19, Redrum and Kong respectively.

## 2. Navigate to the desired location in the Browser.

In the picture below, we have clicked the Song Samples location and expanded all folders and subfolders:

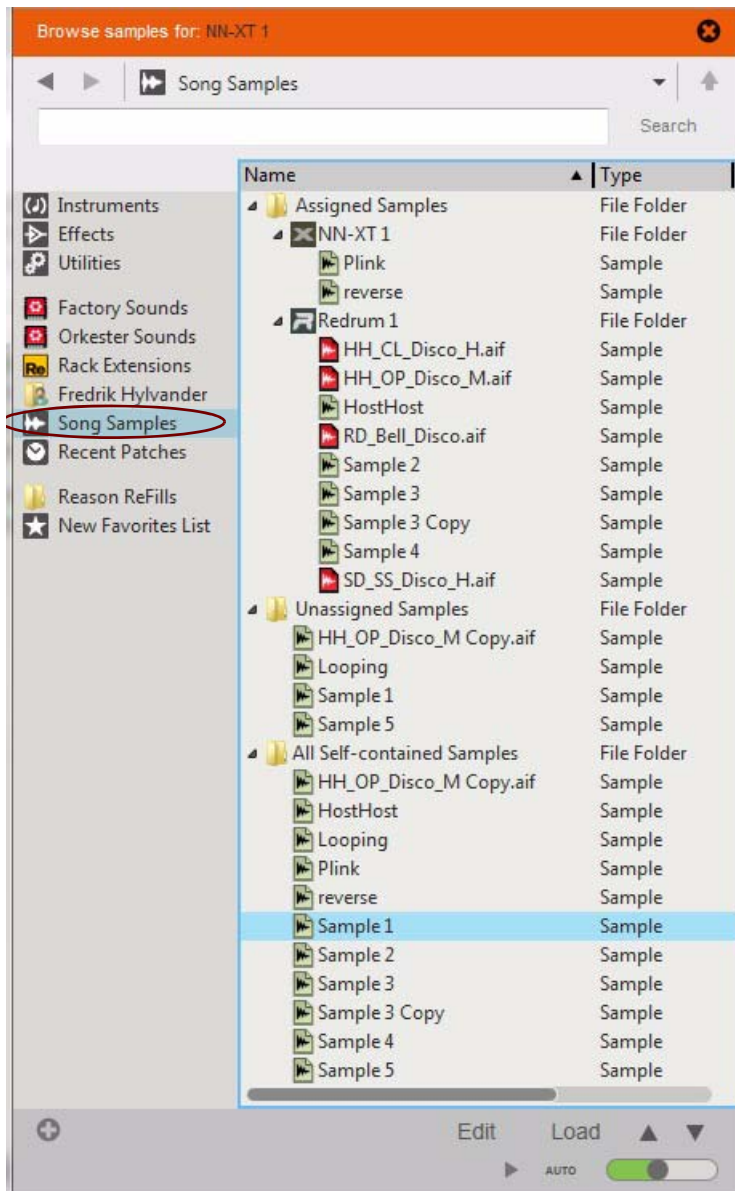

### 3. Select the sample you want to load into your device.

You can select a sample in any of the folders. If you like to audition a sample, click the Play button below the Browser list. To make samples automatically play upon selection, click the Auto button.

### 4. Click the Load button (or double click the sample) to load the selected sample into the device.

When the selected sample has been loaded into the device, the corresponding sample file icon in the Browser has been placed under the device's icon in the Assigned Samples folder. If the loaded sample was originally in the Unassigned Samples folder, it has now been moved from this folder to the Assigned Samples folder:

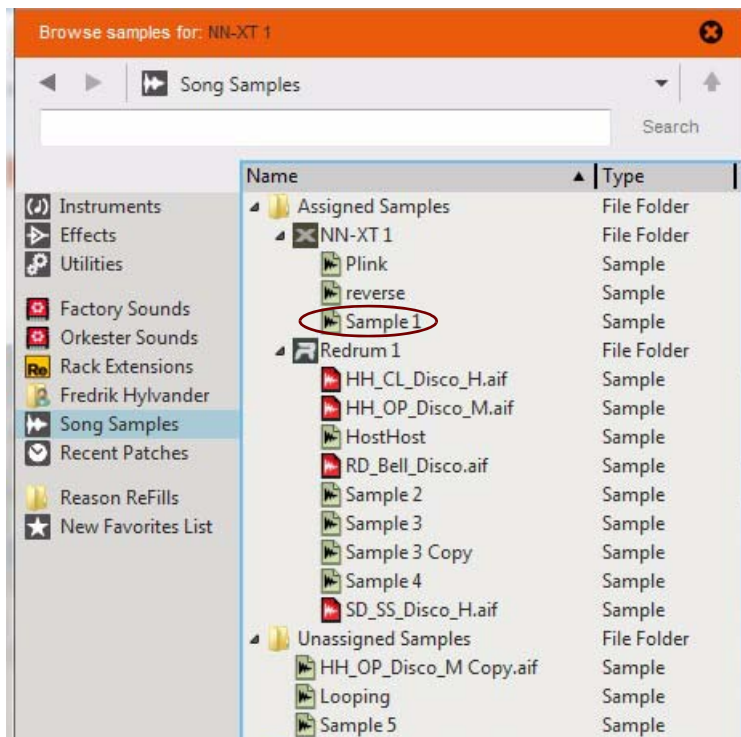

## Duplicating samples

If you want to use an existing sample as base for new edits, you can do this by first duplicating the existing sample and then performing the edits on the duplicate. It's even possible to duplicate samples from the Factory Soundbank and from any existing ReFills! However, duplicated samples from the Factory Soundbank or from ReFills cannot be exported to disk as separate files, but can only be saved as self-contained samples inside the song document.

To duplicate a sample, proceed as follows:

### 1. Select the desired sample in the Song Samples location in the Browser.

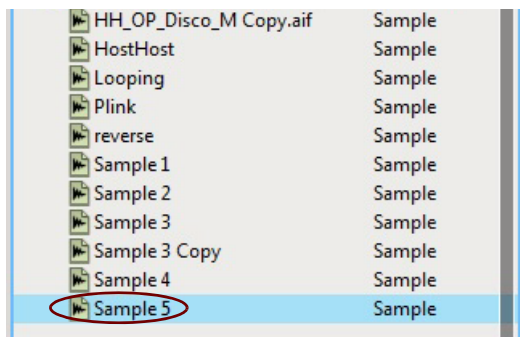

## 2. Select “Duplicate Sample(s)” from the context menu.

The duplicated sample appears - with its original name followed by the word “Copy” - in the All Self-contained Samples folder. The sample also appears in the Unassigned Samples folder:

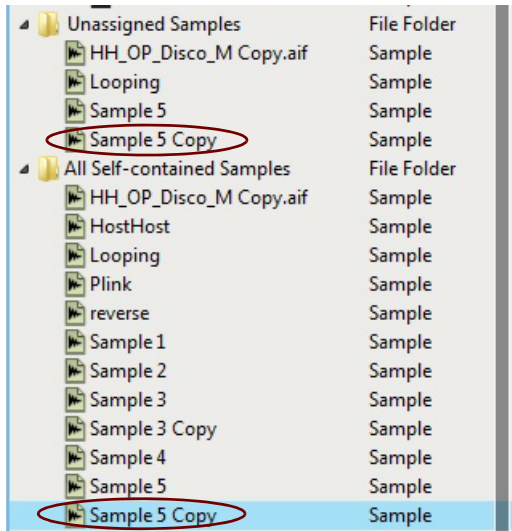

To edit and/or rename the duplicated sample, refer to [“Editing samples”](#) and [“Renaming samples”](#).

## Exporting samples

If you like you can export samples that you have recorded in your song and save them as separate WAV or AIFF files to disk. Proceed as follows:

### 1. Select desired sample(s) in the Song Samples location in the Browser.

! Note that it is not possible to export samples that originate from the Factory Soundbank or from a ReFill.

### 2. Select “Export Sample(s)” from the context menu.

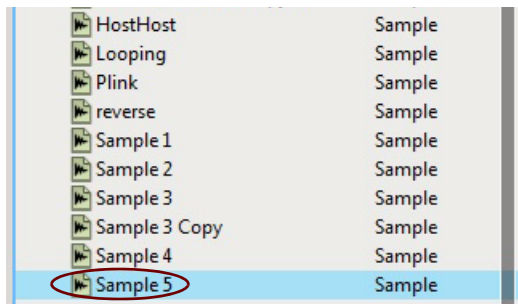

- If your sample(s) are not cropped, or use a Crossfade Loop, the Lossy Sample Export dialog appears:

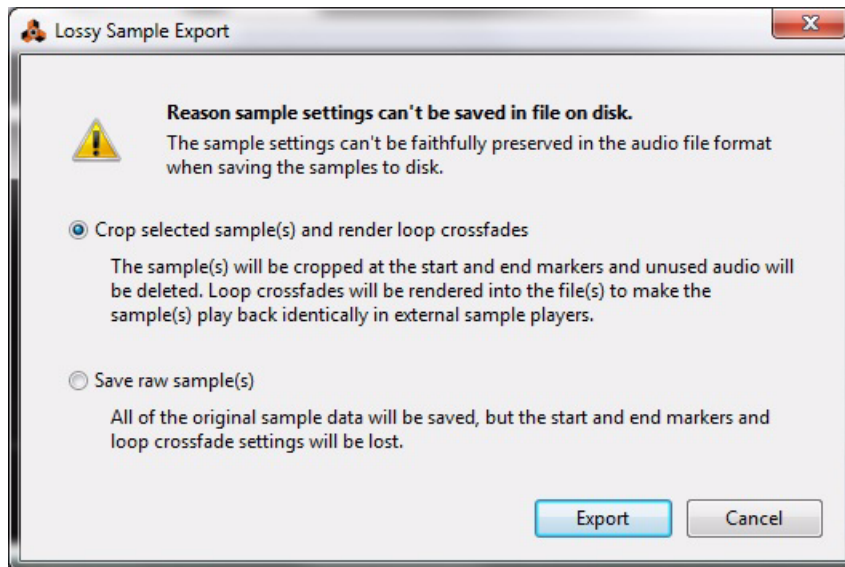

The following options are available:

- **Crop selected sample(s) and render loop crossfades**  
This item shows up if you have edited the Start and/or End Markers and use a Loop with Crossfades. The sample will be cropped at the Start and End Markers and the crossfaded loop will be rendered into the sample.  
**! This will make the sample sound exactly the same when you import it to a sample playback device/application, but the sample data has been changed compared to the original.**
  - **Crop selected sample(s)**  
This item shows up instead of the above item if no Loop is used. The sample will be cropped at the Start and End Markers.
  - **Save raw sample(s)**  
The sample will be exported without Start or End Marker position data but with Loop data, if any. If the loop is crossfaded, the crossfade will be removed.  
**! This will make the sample sound differently when you import it to a sample playback device/application.**
- 3. Click Export to proceed.**  
The “Export Sample as...” dialog appears;

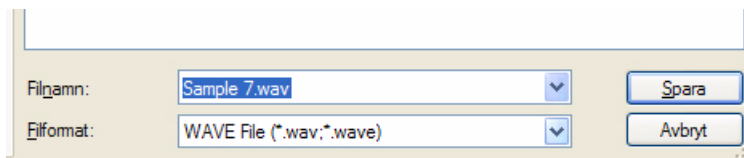

- 4. Choose location for your sample file, type in desired name and choose WAV or AIFF file format.**
- 5. Click Save to export the sample file to disk.**  
The sample is saved to disk using its original resolution (bit depth) and sample rate. The original self-contained sample in your song will remain intact.

## About self-contained samples

All samples you record in a song automatically become self-contained. Self-contained means that the samples are automatically stored within the song when you save it. A great advantage with this is that you never have to keep track of any “loose” custom samples you use in your song - they are always included in the song document.

All self-contained samples in a song can be viewed by unfolding the All Self-contained Samples folder in the Song Samples location in the Browser:

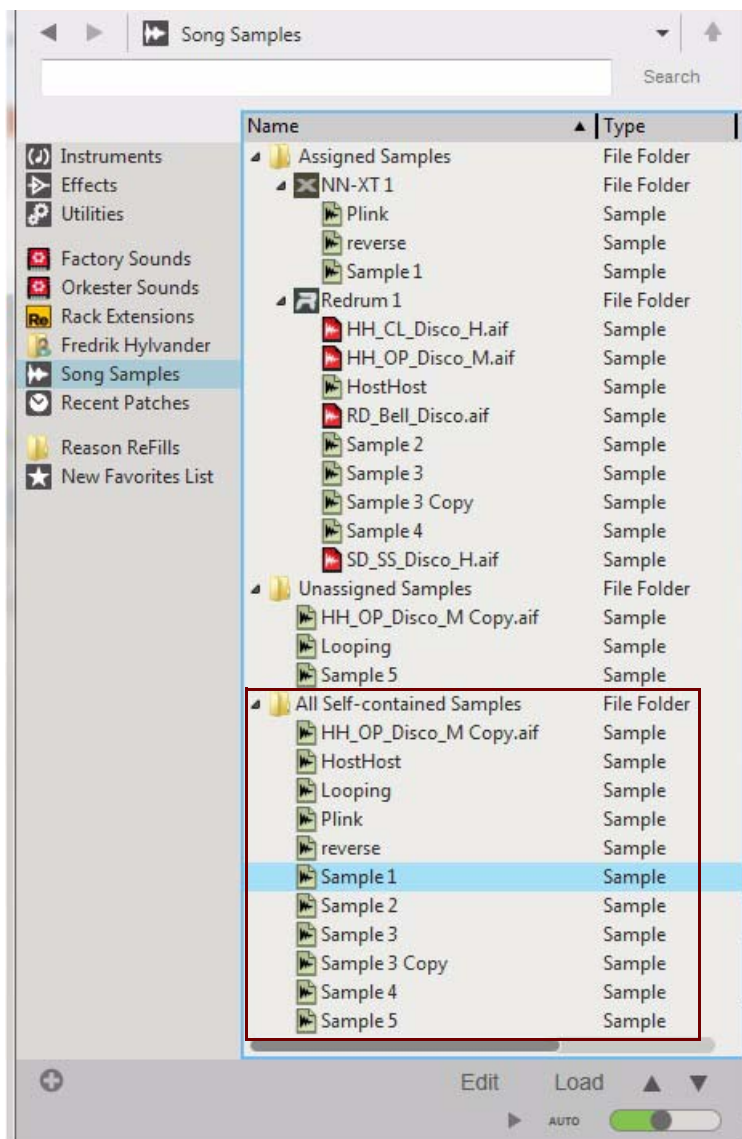

Self-contained samples can also be loaded into any sampler device from the Browser. See [“Loading samples into a device”](#) for more details.

## Un-self-containing samples

There might be situations where you want to “un-self-contain” your own samples, i.e. export the samples to disk as separate files and at the same time remove them from the song document. This can be done by selecting “Song Self-Contain Settings...” from the File menu - see [“About Self-Contained Songs”](#) for more details.





# **Chapter 19**

## **The ReGroove Mixer**

# Introduction



The ReGroove Mixer combines all the benefits of quantization, shuffle, and groove templates into a single integrated environment, giving you real-time creative control over the feel and timing of individual note lanes. The ReGroove Mixer, which extends from the top of the Transport Panel puts 32 channels of interactive groove control at your fingertips.

If you're familiar with mixing, you're already well on your way toward understanding the ReGroove Mixer. Think of it as a mixer with 32 busses but, instead of these busses modifying the volume of the input tracks, they modify the feel (or groove) of the input tracks. You can route any note lane to one of ReGroove's 32 channels, and that lane's feel and timing are modified, in real-time, by the channel's settings. Each ReGroove channel can use its own groove template or shuffle amount. In addition, each channel can slide notes forward or backward in time, allowing you to put certain tracks slightly ahead or behind the beat, which greatly alters the feel of your music.

**! Note that ReGroove only works for notes on note lanes.**

- It's also possible to lock a control surface to control the ReGroove Mixer parameters via Remote - see **"Locking a surface"**.

## ReGroove basics

When working with grooves, you'll make use of three interacting sections within Reason's interface:

- **First, in the Sequencer, each note lane can be assigned to any of ReGroove's 32 channels.** You assign a note lane to a groove channel by selecting it with the Select Groove pop-up in each note lane.

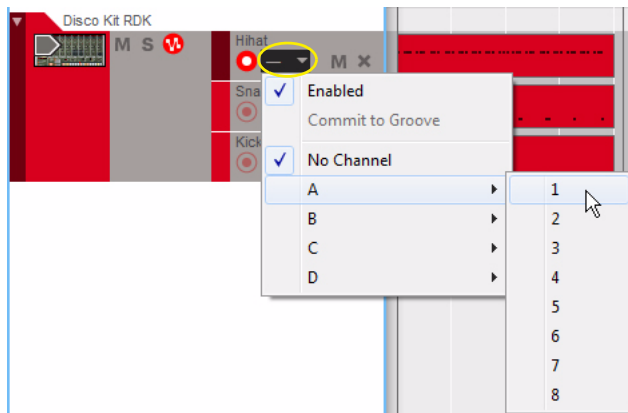

- **Second is the ReGroove Mixer, which contains both global groove settings and channel-specific ones.** This is described on the following pages.
- **Finally, there's the Groove Settings section of the Tool Window, which is accessed by clicking a ReGroove channel's Edit button.** Groove Settings allow you to set the intensity of various groove patch parameters. This is also where you save your own ReGroove patches. See **"Groove Settings"**.

# The ReGroove Mixer

→ Open the ReGroove Mixer by clicking the Groove button to the left on the Transport Panel.

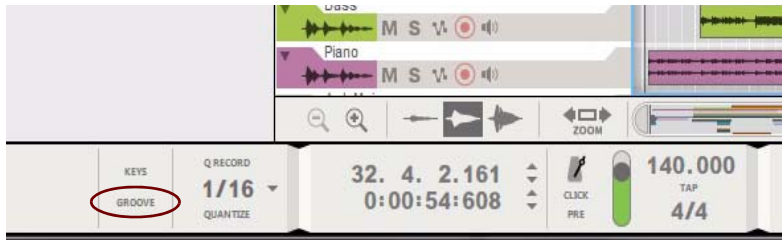

The ReGroove mixer is divided into two sections. On the left are the Global parameters, and on the right are the Channel parameters.

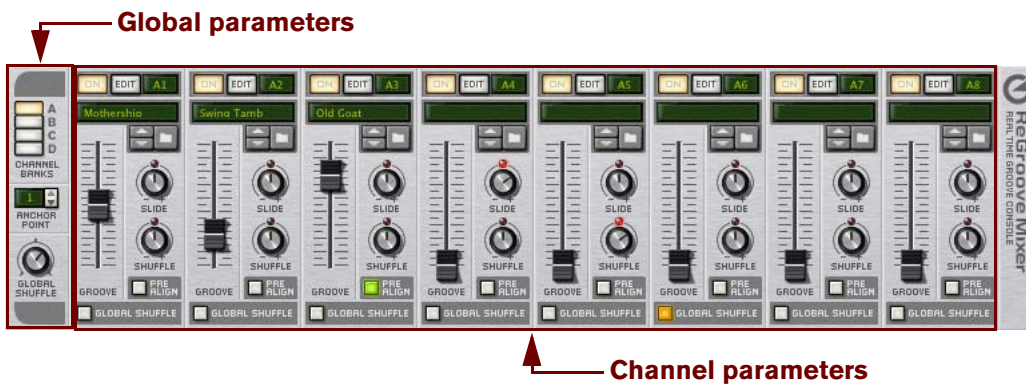

## Global parameters



These parameters operate globally, rather than channel-by-channel.

## Channel Banks

The ReGroove mixer consists of 32 channels, grouped into 4 banks (labeled A through D). Click a Channel Bank button to see and edit its corresponding bank of 8 channels.

## Anchor Point

Normally, all groove patterns start at Bar 1 and repeat themselves throughout a song. For example, a 4-bar groove pattern will begin at Bar 1 and repeat its pattern every four bars. Many times, however, songs begin with blank measures, pickup measure or, perhaps, a short introduction. In these cases, you probably don't want the groove pattern to begin at Bar 1, but at some later bar. This is the purpose of the anchor point - it tells Reason at which measure it should begin applying the groove settings.

For example, assume you have a song with a 1-bar pickup. Because the song really begins on bar 2, that's where you want your groove to begin. Setting the anchor point to 2 insures that the groove patterns all begin at measure 2.

→ **Note: There is one exception to the rule that grooves start playing at their anchor point and repeat indefinitely throughout the song-and that's when they encounter a time-signature change. Grooves always restart at any measure containing a time signature change.**

You can use this knowledge if, for example, you have a song section with an odd number of bars-inserting a time signature change will force all your grooves to restart at that measure.

## Global Shuffle

This knob adjusts Reason's global shuffle amount, and is used by any devices that employ patterns, such as ReDrum's internal sequencer, the Matrix pattern sequencer, and the RPG-8 arpeggiator. It also defines the shuffle value for any ReGroove channel for which the Global Shuffle option is activated.

Setting the Global Shuffle to a value of 50% results in a "straight" beat, with no swing applied. Setting the Global Shuffle to a value of 66% results in a perfect sixteenth-note triplet shuffle. Values between 50% and 66% have a less pronounced swing feel, and values greater than 66% are more exaggerated.

- **If you are quantizing notes and/or audio Slices to "Shuffle" in the "Quantize" section in the Tool Window, these are quantized to the current Global Shuffle value.**

## Channel parameters

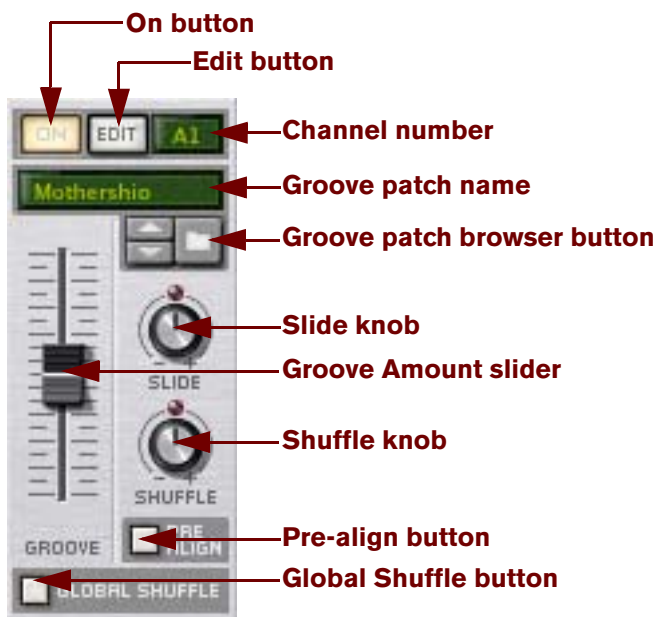

These parameters operate on a per-channel basis. Each of ReGroove's 32 channels (arranged in 4 banks of eight) contains an identical set of parameters.

## On Button

This is an On/Bypass button for the channel. When the button is lit, the groove channel is active and any note lane assigned to this groove channel will be affected. When the button is not lit, the channel is disabled and any note lanes assigned to this groove channel will play back straight, without being “grooved.”

- **This can be used for comparing the groove with the original, ungrooved beat. You can also do this for individual note lanes, by turning off the “Enabled” item on the Groove Select pop-up menu in the track list - see “Applying grooves to your music”.**

## Edit Button

Click this button to open Reason's floating Tool Window, and show the Groove tab, where you can view and edit additional “Groove Settings” for each channel.

Each ReGroove channel has its own groove settings, so clicking the Edit button in different channels will fill the Tool Window with groove settings specific to that channel.

## Channel Number

This is a non-editable channel number label. Channels are numbered 1-8 and are grouped into 4 banks (A-D). Channel numbers are named accordingly. For example, A2 is the second channel in Bank A, and B5 is the fifth channel in Bank B.

## Groove Patch Name

This shows the name of the groove patch currently loaded into the channel. If no groove patch is loaded, then no name appears. Click this area to bring up a list of the patches in the current folder, just as with patch displays on devices in the Reason rack.

- **To remove a groove patch assignment and reset the channel to its default values, right-click (Win) or [Ctrl]-click (Mac) the Groove Patch name, or anywhere on the ReGroove panel background, and select “Initialize Channel” from the context menu.**

## Groove Patch Browser

This allows you to load groove patches and to step between them, just like device patches in the Reason rack. ReGroove patches have a .grov extension. See “ReGroove patches in the Factory Sound Bank”, later in this chapter, to learn more about the types of groove patches included with Reason.

## Slide

Use this knob to slide notes forward or backward in time. Musicians will frequently add energy and urgency to a track by “rushing” a particular beat or instrument a little. Similarly, they may “drag” a note a little in order to create a more laid back, shuffle-like feel. The Slide knob has a range of  $\pm 120$  ticks, which allows you to slide notes up to a thirty-second note in either direction. Setting negative values makes notes play earlier in time (rushing the feel). Setting positive values makes notes play later in time (lagging the feel).

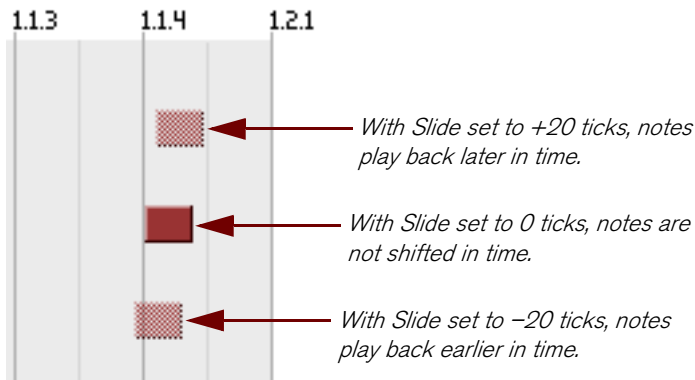

For example, if you wanted to create a slightly “in the pocket” groove, you could create a snare lane and assign it to a ReGroove channel with a small amount of positive slide. This would delay the snare track slightly, giving your music a relaxed, laid back feel.

- If you have a track that you want to rush (set to a negative slide value), you should put an empty bar at the beginning of your sequence, making sure to set the Anchor Point to “2” (see “Anchor Point”). This insures that any notes assigned to Bar 1/Beat 1 will indeed play ahead of the beat (since you created an empty measure into which the early note can shift).

## Shuffle

At its most basic level, this knob adds a sixteenth note “swing” feel to the ReGroove channel. A value of 50% results in a straight (no shuffle) feel, and a value of 66% creates a perfect triplet feel.



*Shuffle works by changing the start time of every other sixteenth note.*



*A shuffle value of 66% delays every other sixteenth note to create a perfect triplet feel.*

You can also use this knob to “de-shuffle” a beat by dialing in values below 50%. For example, if you had a recording that was played with a perfect triplet feel, setting the Shuffle value to 34% will make the beat straight again!

## Groove Amount

Use this fader to adjust how intensely the selected groove patch will modify your notes. At 0%, the groove patch will have no effect. At 100%, the groove patch will have its maximum effect. Obviously, values between these extremes will produce some amount of groove effect, but less than maximum.

As discussed in “Groove Settings”, later in this chapter, several additional parameters are associated with groove patches and how they modify your notes. Specifically, the Groove Settings section of the Tool Window contains four “impact” settings (timing, velocity, note length, and randomness), and the Groove Amount fader acts like a “master” fader that scales these four parameters proportionally.

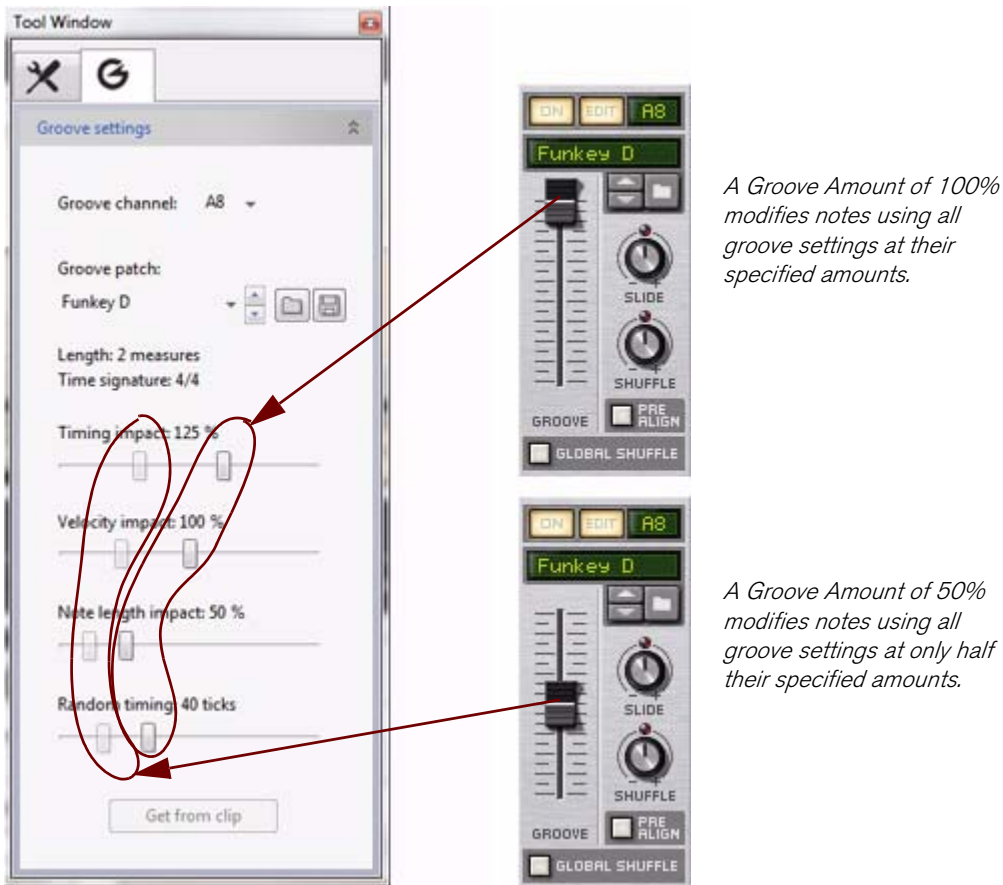

## Pre-Align

Enabling this button causes any incoming notes to be quantized to a rigid, sixteenth note grid prior to having any additional groove modifications applied to them. This quantization, which occurs in real time and is non-destructive, is an easy way to align all incoming notes to a “straight” grid, so that any shuffle, slide, or groove modifications have the expected effect on the notes.

## Global Shuffle

Enabling this button causes the ReGroove channel to use the “Global Shuffle” setting, rather than the channel's own shuffle setting. The channel's Shuffle knob will have no effect when a channel uses global shuffle. Using global shuffle is a good way to synchronize notes in a particular channel with those in pattern-based devices, such as Redrum's internal sequencer, the Matrix pattern sequencer, and the RPG-8 arpeggiator, all of which get their shuffle values from the Global Shuffle value.

## Copy, Paste and Initialize ReGroove channels

To copy one ReGroove channel configuration into another:

1. **Decide which ReGroove channel you want to copy from, then right-click (Win) or [Ctrl]-click (Mac) on the Groove Patch Name (or anywhere else in that channel, except directly on a parameter).**

A context menu appears.



2. **Select “Copy Channel” from the context menu.**
3. **Right-click (Win) or [Ctrl]-click (Mac) on the destination channel's Groove Patch Name, then select “Paste Channel” from the context menu.**

Reason copies all the ReGroove channel settings to this channel.

To initialize a ReGroove channel:

1. **Right-click (Win) or [Ctrl]-click (Mac) on the Groove Patch Name (or anywhere else in that channel, except directly on a parameter) to open a context menu.**
2. **Select “Initialize Channel” from the context menu.**

Reason resets all channel parameters to their default values.



# Groove Settings

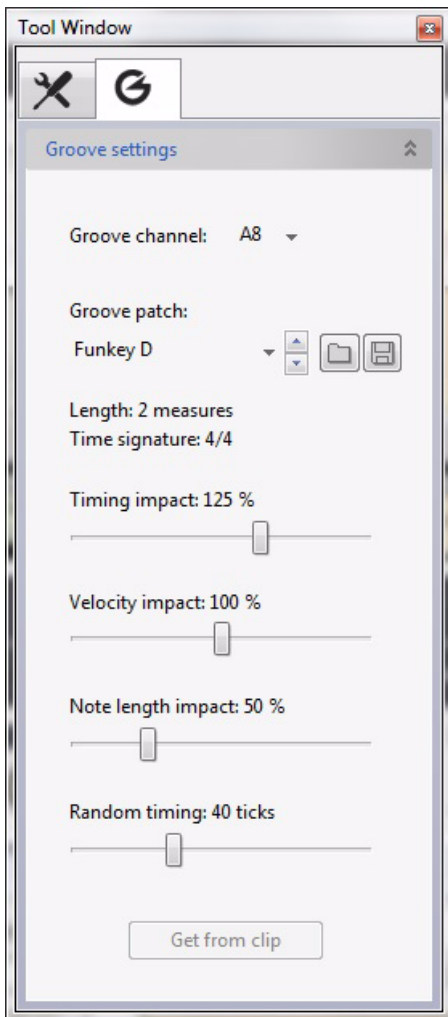

A groove patch consists of a groove template, which contains timing and dynamics information extracted from a performance, plus a collection of Impact parameters, which determine how strongly the groove patch applies the template settings. This section discusses the settings on the Groove tab in the Tool window, which is where all the Groove Patch settings are viewed and edited.

## Groove channel

The Groove Settings display one mixer channel at a time. To select which ReGroove channel is currently displayed, select it from this pop-up (or click the Edit button for the channel in the ReGroove Mixer).

## Groove patch name

This shows the name of the groove patch currently loaded into the channel. If no groove patch is loaded, then no name appears. Click this area to bring up a list of the patches in the current folder, just as with device patches in the Reason rack. This area duplicates the functionality of the Groove Patch Name area in each channel of the ReGroove Mixer.

## Groove patch Load/Save

These buttons allow you to load and/or save groove patches, just like device patches in the Reason rack. ReGroove patches have a .grov extension. To learn more about the types of groove patches included with Reason, see "[ReGroove patches in the Factory Sound Bank](#)".

## Groove patch Length

This displays the groove's length, which is import for determining how often the groove repeats.

- **In general, if you apply different groove patches to different note lanes, you'll want their lengths to be multiples of one another.**

For example, if one ReGroove channel uses a 4-bar groove, you might want to use 4-bar grooves on other channels or, perhaps, a multiple (such as 1-bar, 2-bar, or 8-bar grooves).

You can, of course, mix and match grooves with non-standard lengths, but you need to be aware of how these grooves will interact. For example, if one channel used a 3-bar groove and another used a 4-bar groove, the groove pattern would actually repeat every 12 bars (3-bars times 4-bars).

## Groove patch Time signature

This displays the groove's time signature and should, in most cases, match the time signature of your sequence.

- **In general, if you apply different groove patches to different note lanes, you'll want them to share a common time signature.**

You can, of course, mix and match time signatures to create polyrhythmic grooves, but you need to be aware of how these grooves interact. For example a 6/8 groove will shift notes in a radically different way than a 4/4 groove, so applying them simultaneously may or may not sound the way you expect.

## Timing impact

This determines the extent to which timing information embedded in the groove template affects the position of your notes. A 50% setting means that notes are moved halfway to the positions defined in the groove template. 100% means they are moved exactly to the positions in the groove, and 200% means they are moved just as far past the groove template positions.

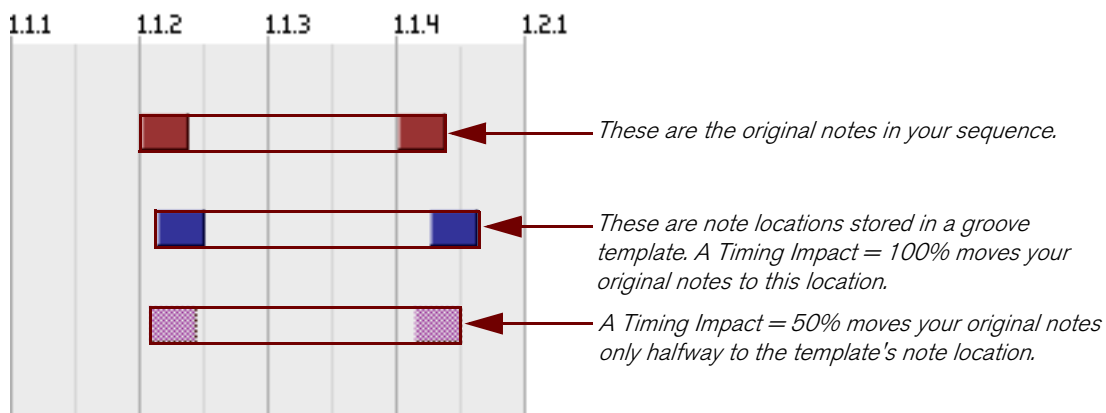

- **This parameter works in conjunction with the ReGroove Mixer's Groove Amount fader, which can scale back the groove's timing impact.**

For example, if the Groove Amount fader is set to 100%, then notes are moved by the indicated Timing Impact amount, but if the Groove Amount fader is set to 50%, then notes are moved by only half the Timing Impact amount.

## Velocity impact

This determines the extent to which velocity information embedded in the groove template affects the velocity of your notes. Grooves modify only the relative differences between note velocities, not their absolute values. This way, soft passages remain soft and loud passages remain loud—the groove simply accents the notes differently. A 100% setting means that the feel is more or less exactly transferred from the template to your music. Values below this mean that less of the groove's dynamics affect your notes, and values above 100% dramatically increase the dynamic effect of the groove patch.

→ **This parameter works in conjunction with the ReGroove Mixer's Groove Amount fader, which can scale back the groove's velocity impact.**

For example, if the Groove Amount fader is set to 100%, then velocities are modified by the indicated Velocity Impact amount, but if the Groove Amount fader is set to 50%, then velocities are modified by only half the Velocity Impact amount.

## Note length impact

This determines the extent to which note length information embedded in the groove template affects the length of your notes. This setting is not always relevant (such as with drum samples, which always play at their full length) and, consequently, most grooves in the Factory Sound Bank do not contain any length information (with the exception of the “Bass-Comp” category).

That said, when working with sustaining instruments, note length can have a dramatic impact on the performance's feel. Grooves modify only the relative differences between note lengths, not their absolute values. This way, legato or staccato passages retain some of their original intent when modified with a groove patch.

→ **This parameter works in conjunction with the ReGroove Mixer's Groove Amount fader, which can scale back the groove's note length impact.**

For example, if the Groove Amount fader is set to 100%, then note lengths are modified by the indicated Note Length Impact amount, but if the Groove Amount fader is set to 50%, then note lengths are modified by only half the Note Length Impact amount.

## Random timing

This determines the extent to which note positions are randomized. This value defines the maximum distance that a note can be randomly shifted (in either a positive or negative direction). You may set an amount between 0 ticks (no randomization occurs) and 120 ticks, which allows notes to shift as much as a thirty-second note in either direction.

The effect is “polyphonic,” meaning that any notes originally beginning at the same position will still be moved by different amounts. It is also “semi-deterministic,” meaning that if you play a clip several times, without editing anything, all notes will play back at exactly the same positions each time. However, as soon as you edit the clip in any way, all random positions are recalculated.

→ **This parameter works in conjunction with the ReGroove Mixer's Groove Amount fader, which can scale back the randomization.**

For example, if the Groove Amount fader is set to 100%, then notes are randomized by the indicated Random Timing amount, but if the Groove Amount fader is set to 50%, then notes are randomized by only half the Random Timing amount.

## Get from clip

This button converts the notes in a selected clip into a groove patch. The patch can then be used right away in the active ReGroove Mixer Channel or saved to disk as a new groove patch. Clicking this button has the same effect as selecting a clip and choosing “Get Groove From Clip” from the Edit (or context) menu. See [“Creating your own ReGroove patches”](#).

# Working with grooves

## Applying grooves to your music

Follow this example to learn basic ReGroove mixing techniques and hear the effect that various groove parameters have on your music.

1. If it's not already visible in either the Sequencer or Rack, open the ReGroove Mixer by clicking the Groove button to the left on the Transport Panel in the Sequencer.



2. Decide which note lane you are going to apply the groove to.

For the most obvious effect the track should contain a drumbeat based on straight (as opposed to shuffled) sixteenth notes. A hi-hat lane, for example, might be a good source for experimentation.

3. Use the Groove Select pop-up on the chosen note lane to route those notes to a specific ReGroove mixer channel.

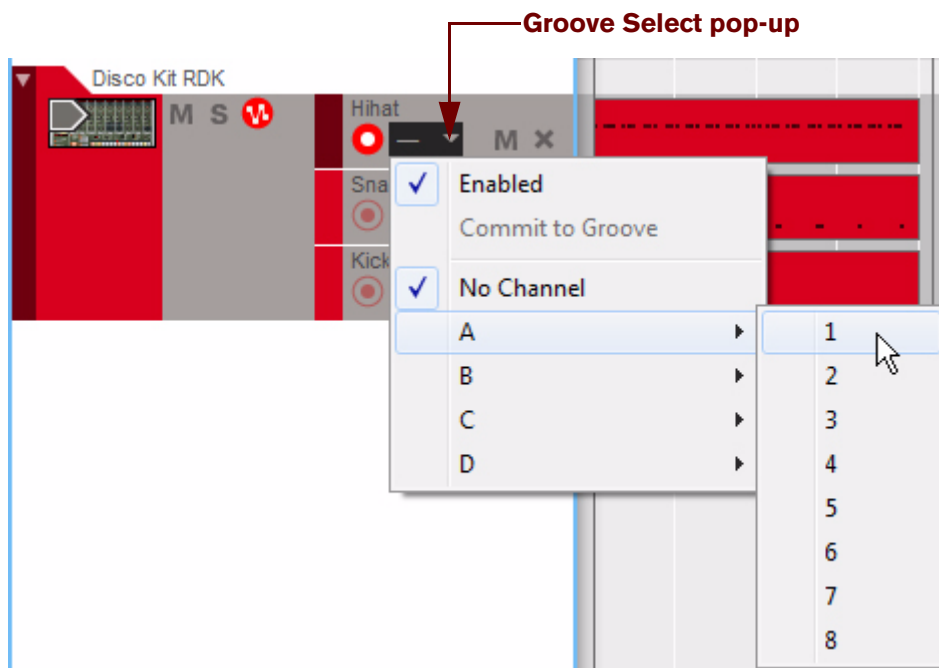

- The “Enabled” item at the top of the pop-up menu allows you to turn ReGroove off for individual note lanes. This is useful for comparing with the original, ungrooved beat. If you want to do this for several note lanes set to a particular ReGroove channel, use the “On” button for the channel in the ReGroove mixer instead (see “On Button”).
  - To turn ReGroove off for a note lane, select “No Channel”.
4. In the ReGroove Mixer, make sure the channel you are using is activated - the On button should be lit.

5. To hear some of the different possibilities, start by turning up the channel's Shuffle knob while you play the sequence.



The music on that note lane (and any other note lane assigned to the same ReGroove channel) will start playing with a shuffle feel.

6. Turn down Shuffle to its middle position (50%), and turn up the channel's Slide knob to hear its effect.



- Note that, because slide shifts all notes by the same amount, you won't hear the results unless you play the track in conjunction with another track whose notes are not being slid (or with Click activated in the sequencer).

7. Turn the Slide knob back to its middle position (0 Ticks), then click the channel's Browse button to set Browse focus to the ReGroove Patches folder in the Factory Sound Bank.

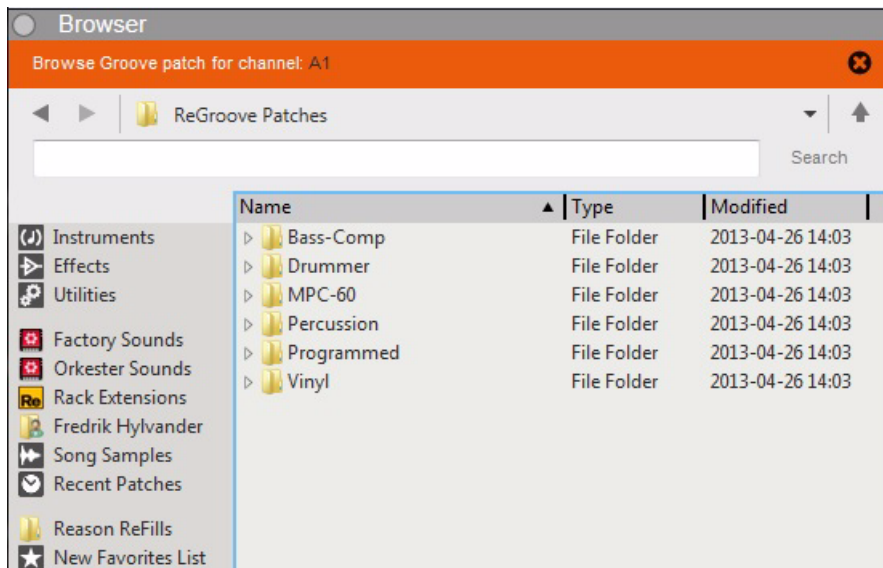

8. Open the Vinyl folder, select the first groove patch in the list and click Load to load the groove patch.  
9. Pull up the Groove Amount fader on the channel, to about 80%.



10. Click the Next Patch button to step through the groove patches in the folder and hear what they do to your music.
11. On the ReGroove Mixer channel, click the Edit button to open that channel's groove settings in the floating Tool Window.
12. Move the various horizontal faders and listen for their effect.  
Note that none of the patches in the Vinyl folder make use of Note Length, so the Note Length Impact will have no effect.
- There are all sorts of creative and useful ways to apply grooves to your music. See **“Groovy tips & tricks”**, later in this chapter, for some suggested techniques.

## Commit to Groove - making the grooves “permanent”

When you assign a ReGroove channel to a note lane, this will only affect how the notes play back. The notes will still be shown with their original, ungrooved positions if you open the note clip.

If you want to edit grooved notes (e.g. adjust timing and velocity manually), it's useful to first actually move the notes to the grooved positions, permanently. This is done with the “Commit to Groove” function:

1. **Select the track with the grooved note lane(s).**
2. **Select “Commit to Groove” from the Edit menu or the track context menu.**

All notes on all lanes on the track will be moved to their grooved positions, and the Groove Select pop-up will be reset to “No Channel”.

If you play back the track, it will sound exactly the same as before. If you look at the notes in Edit mode, their positions, length and velocity will now match what you hear.

### Using Commit to Groove on some lanes only

“Commit to Groove” affects entire tracks, including all note lanes if there are several. If you only want to make the groove permanent for one of the lanes, here's a workaround:

1. **Click the Groove Select pop-up for the note lanes that should remain ReGrooved, and turn off “Enabled”.**

This bypasses the ReGroove channel for those note lanes, but retains the channel selection.

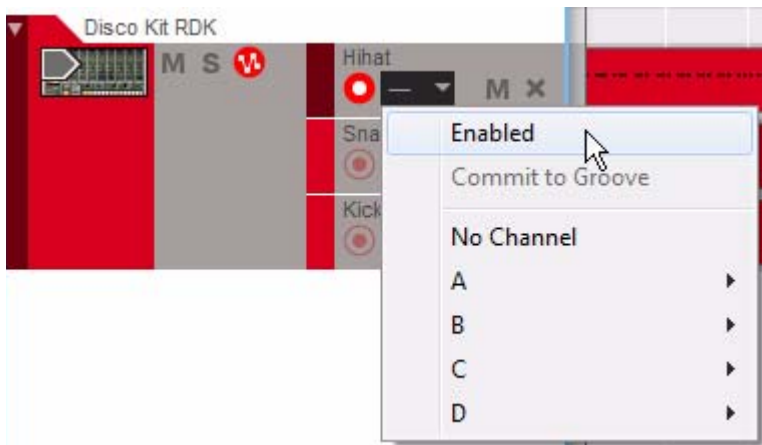

2. **Select “Commit to Groove”.**  
Only the note lanes with ReGroove Enabled will be affected.
3. **Select “Enabled” again for the note lanes that should remain ReGrooved.**

# Creating your own ReGroove patches

To create your own ReGroove Patch, proceed as follows.

**1. Create a clip containing notes with the desired timing and dynamics (velocity).**

Alternatively, you could import a MIDI File with the desired effect, or use the “Copy Loop To Track” function on a Dr. Octo Rex device to extract the notes from a REX loop.

→ **Note that some MIDI clips will make better grooves than others.**

To learn some of the characteristics of a good groove-making clip, see “[Tips for selecting the best Groove-Making Clips](#)” below.

**2. Select the clip.**

**3. In the Tool Window's Groove section, select an unused Groove Channel.**

**4. Click the “Get from clip” button at the bottom of the Tool Window's Groove Settings tab.**

Alternatively, you could select “Get Groove From Clip” from the clip's context menu.

**5. Set the various impact parameters as desired.**

For a good starting point, you can simply leave them at their default settings.

**6. Click the Save Patch button in the Tool Window's Groove section and specify a name and location.**

Your ReGroove patch is now ready to use. As discussed in “[Applying grooves to your music](#)”, simply route one or more note lanes to the ReGroove channel assigned to your new groove, and pull up the Groove Amount fader on that channel.

## Tips for selecting the best Groove-Making Clips

The following tips will help insure that your custom grooves work their best:

→ **Include as many sixteenths notes as possible in the source clip.**

If there are any sixteenth note gaps in your source material, there will be corresponding gaps in your groove patch. This means, when you apply the groove to a note lane, some notes will be grooved and some (those that fall in the gaps) will not.

→ **Grooves use the relative differences between note velocities, not their absolute values.**

If you don't want dramatic shifts in dynamics, avoid having widely varying velocities in your source clip.

→ **Groove patches are always an exact number of bars, so if your source clip has an uneven length, the groove will be extended to the next bar.**

We recommend that you adjust your source clip to an exact number of bars before creating a groove patch.

→ **In general, you should use source clips whose length is an even multiple of 2 (for example, 1-bar, 2-bars, 4-bars, etc.)**

You can create and use grooves that are an odd number in length (3, 7, 13, etc.), but unless you're well organized and plan to use these grooves in specific polyrhythmic pieces, their general effect on most tracks will be somewhat unpredictable.



# Groovy tips & tricks

- **Because you can route each note lane to any of the 32 ReGroove channels, the key to creating really dynamic grooves is to spread your instrumentation across multiple note lanes.**

For instance, where you might normally create a Redrum sequence with kick, snare, and hi-hat all on the same track, putting these elements into different lanes will let you apply different grooves to them. For example, you might have a kick lane routed to a ReGroove channel with a slight shuffle feel, and you might send the snare to a ReGroove channel that slides the notes earlier in time to “push” the backbeat a little. Breaking things into lanes will definitely enable you to create beats that are more loaded with feel and personality than if you simply apply one groove setting to everything.

- See **“Extract Notes to Lanes”** for tips on how to automatically distribute notes from one note lane to several additional note lanes.
- **When building a groove, start simple. Experiment with adjusting the slide parameter to move just the snare or hi-hat forward or backward in time.**

Try applying slightly different amounts of shuffle to different percussion instruments. Small changes can sometimes have a big visceral effect, so use your ears (and not your eyes) when adjusting the various groove settings.
- **Try applying the same groove patch to multiple lanes, but by varying amounts.**

You are, of course, free to apply different groove patches to different lanes. Though, more often than not, your results might result in something that sounds more clumsy than groovy. The hottest grooves often have the most subtle of humanization.
- **Don't forget to try sending sequenced REX files through the ReGroove mixer.**

Depending on the material in the file and how it's sliced up, this can create all types of results-ranging from unusable to downright inspiring.
- **If you're doubling instruments - that is two instruments play the exact same part - try sending one of the instruments to a ReGroove channel that has a small amount of random timing applied.**

Random timing (which is accessible in the Groove Settings section of the Tools Window) will put some separation between the two instruments, making their performance sound more human. For example, if you have a clap doubling a snare, apply a little bit of random timing to the clap track, and it'll stand out more clearly in the mix.
- **As described under the “Anchor Point” heading above, grooves restart whenever a new time signature appears.**

You can use this knowledge to force a groove to restart, which might be required if your music contains sections of odd lengths. Simply add in a time signature event, with the same type of time signature as you already have in the song. The groove will restart where the event starts.
- **Remember that groove patches have separate timing and velocity impacts and, as such, you can apply them independently.**

For example, if you already have a track that has just the right groove timing, but you want to experiment with different dynamic feels, you can apply just the velocity portion of a groove by setting its Timing Impact parameter to 0. A groove's timing and velocity impact parameters can be accessed by clicking a ReGroove channel's Edit button, which opens the Groove Settings section of the Tools Window.

# ReGroove patches in the Factory Sound Bank

Reason ships with a ready-made assortment of groove patches, arranged in a number of different folders:

## **Bass-Comp, Drummer, and Percussion**

Grooves in these categories were created by session musicians. Their performances were captured and analyzed, and the timing and velocity information was then extracted from the performances. The Bass-Comp patches also contain note length information, though the other categories do not.

## **MPC-60**

These grooves were created by analyzing the audio output of an Akai MPC-60. Use these patches to get the same shuffle feeling as an original MPC-60. Note that these patches do not contain any velocity or note length information. There are some additional patches that use the Random Timing feature, which emulates the original MPC-60's behavior when loaded with a lot of information.

## **Programmed**

These grooves were created by a session drum groove programmer. They were hand-crafted to emulate the feel of certain styles, and are divided into two genres: Hip-hop and Pop-Rock. These grooves do not contain any note length information.

## **Vinyl**

These grooves were created by sampling snippets from classic groove records, analyzing them with a special signal processing tool, then extracting both timing and velocity information from the samples. These grooves do not contain any note length information.

# **Chapter 20**

## **Remote - Playing and Controlling Devices**

# About the various MIDI inputs

This chapter describes how you use Remote to set up your master keyboard and control surfaces, allowing you to play Reason devices, adjust parameters and control various Reason functions. This is the main way of sending MIDI to Reason, but there are also some additional methods:

→ **Using ReWire 2.**

ReWire allows you to run Reason together with another application, such as a sequencer or another DAW. With ReWire 2, you can send MIDI from the other application directly to devices in Reason. See [“Routing MIDI via ReWire 2”](#).

→ **Using the External Control Bus inputs.**

The External Control Bus inputs (set up on the Preferences - Sync page and in the MIDI In device in the hardware interface) let you send MIDI directly to the individual devices in the rack. This is mainly used if you control Reason from an external sequencer, etc. See [“About the External Control Bus inputs”](#).

→ **Sending MIDI Clock to Reason.**

This allows you to synchronize Reason's tempo to other devices. See [“Synchronization to MIDI Clock”](#).

# About Remote

MIDI from control surfaces (keyboards, remote control units etc.) is handled by a protocol called Remote. The Remote protocol allows for seamless integration between Reason and control surface devices. It is basically a mapping system that provides direct hands-on control of parameters for each Reason device - including transport and sequencer track selection!

At the time of this writing, Reason supports a large number of control surfaces and keyboards - the knobs, faders and buttons on the devices are automatically mapped to parameters on each Reason device.

Remote drivers for more control surfaces will be added continuously. Check the Propellerhead web page in case your model isn't listed on the Preferences - Control Surfaces page.

Remote controlling Reason devices couldn't be made any simpler. Set up your control surface once and for all for use with Reason - the program handles the rest!

# Setting up

## Adding a control surface or keyboard

This is how you add your control surfaces - including the master keyboard.

1. **Open the Preferences dialog and click the Control Surfaces tab.**
2. **If your control surface is connected via USB (or if you have made a two-way MIDI connection), try clicking the Auto-detect Surfaces button.**

Reason scans all MIDI ports and tries to identify the connected control surfaces. Note that not all control surfaces support auto-detection.

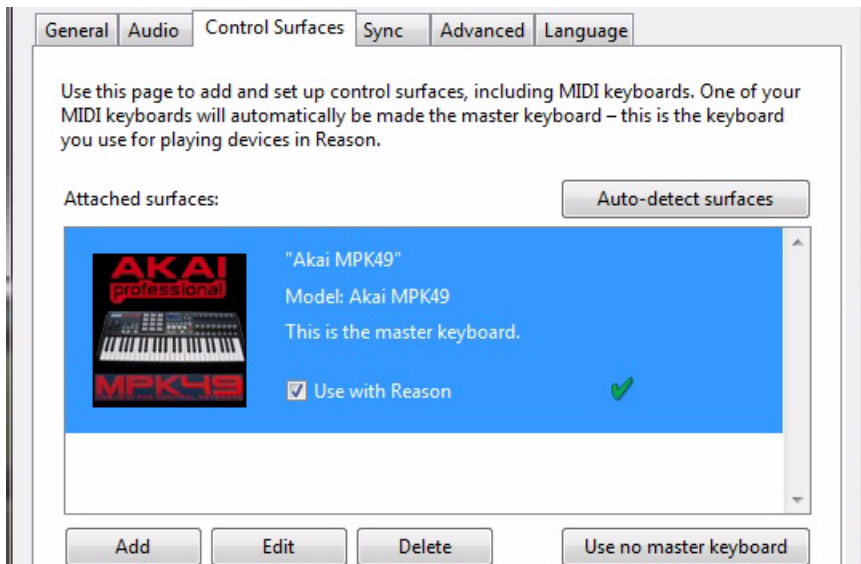

*All found surfaces are listed in the Attached surfaces list.*

3. **To add a control surface manually, click the Add button.**  
This brings up a new dialog.
4. **Select the manufacturer of your control surface from the Manufacturer pop-up menu.**  
If you can't find it on the menu, see below.
5. **Select the model of your control surface from the Model pop-up menu.**  
If you can't find it on the menu, see below.
6. **An image of the selected control surface model is shown, often along with some information text - read this carefully.**  
For some control surfaces, you need to select a specific preset to use the surface with Reason - this is noted here.

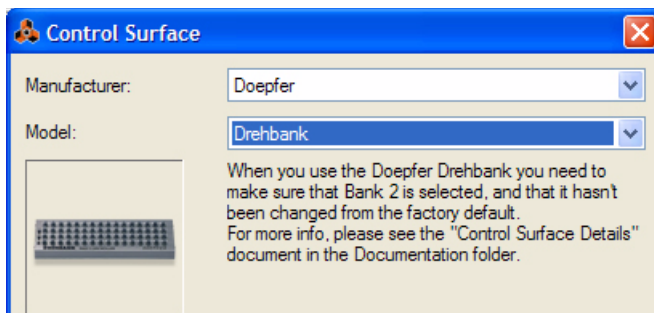

## 7. Use the MIDI Input pop-up to select the input port to which you have connected the surface.

If in doubt, you can click the Find button and then tweak a control or play a key on the control surface to have Reason find the correct input port for you.

### → Some control surfaces may have more than one MIDI Input pop-up menu.

You need to select ports on all MIDI Input pop-up menus.

### → Some control surfaces will have a MIDI Output pop-up menu.

In some cases this is labeled “Optional” - then you don't have to make a selection. In other cases, a MIDI Output is required. This is the case if the control surface uses MIDI feedback - motor fader, displays, etc. See the separate “Control Surface Details” pdf document for details.

### → Reason only “grabs” the MIDI inputs you are actually using.

MIDI inputs not selected here or on the Sync page (see “[Advanced MIDI - The External Control Bus inputs](#)”) are available to other programs.

### → Note that other MIDI programs may “grab” all MIDI ports in your system when you launch them!

## 8. If you like, you can rename your control surface in the Name field.

## 9. Click OK to add the surface.

### → Depending on the surface model, alerts may appear, reminding you to select a specific preset etc.

In some cases, Reason can restore a preset in the control surface to factory settings for you. In such cases you will be informed about this.

Finally you return to the Control Surfaces tab in Preferences, where your added surface is now listed.

## If your control surface model isn't listed

If you can't find your control surface listed on the Manufacturer or Model pop-up menus when you try to add it, this means that there's no native support for that model. However, the program supports generic keyboards and controllers. Here's what to do:

### → Select “Other” on the Manufacturer pop-up menu and then one of the three options on the Model pop-up menu.

or, if the Manufacturer is listed but not your specific model:

### → Select one of the three “Other” options on the Model pop-up menu:

In both cases, the options are:

#### • MIDI Control Keyboard

Select this if you have a MIDI keyboard with programmable knobs, buttons or faders. You need to set up your control keyboard so that the controls send the correct MIDI CC messages, depending on which Reason device you want to control - check out the MIDI Implementation Chart in the Reason Documentation folder. If your control keyboard has templates or presets for Reason devices, these can be used if you run Reason.

#### • MIDI Control Surface

Select this if you have a MIDI controller with programmable knobs, buttons or faders (but without keyboard). You need to set up your control surface so that the controllers send the correct MIDI CC messages, depending on which Reason device you want to control - check out the MIDI Implementation Chart in the Reason Documentation folder. If your control surface has templates or presets for Reason devices, these can be used if you run Reason.

#### • MIDI Keyboard (No Controls)

Select this if you have a MIDI keyboard without programmable knobs, buttons or faders. This is used for playing only (including performance controllers such as pitch bend, mod wheel, etc.) - you cannot adjust Reason device parameters with this type of control surface.

- **MIDI Multichannel Control Keyboard**

Select this is you have a MIDI keyboard with programmable controls that use multiple MIDI channels (different controls send the same MIDI CC but on different MIDI channels). With this model there is no automatic mapping to device parameters - you need to use Remote Overrides to map each control to a parameter on a device.

- **MIDI Multichannel Control Surface**

Select this is you have a MIDI control surface with programmable controls that use multiple MIDI channels (different controls send the same MIDI CC but on different MIDI channels). With this model there is no automatic mapping to device parameters - you need to use Remote Overrides to map each control to a parameter on a device.

After selecting a model, proceed with selecting MIDI input port as described above.

## About the Master Keyboard

One of the control surfaces can be the Master Keyboard. This is like any other control surface, but it must have a keyboard and it cannot be locked to a specific Reason device (in other words, it always follows the MIDI input to the sequencer). This is the surface you use to play the instrument devices in Reason.

- **The first surface with a keyboard that is added (or found by auto-detect) is automatically selected to be the master keyboard.**

This is shown in the Attached Surfaces list on the Preferences page.

- **If you want to use another surface as master keyboard, select it in the list and click the “Make Master Keyboard” button.**

You can only have one surface as master keyboard at a time.

- **If you don’t want to use any master keyboard at all, select the current master keyboard surface and click the same button (which is now labeled “Use No Master Keyboard”).**

## Other functions

- **To edit a surface, double click it in the list (or select it and click Edit).**

This lets you change its name and MIDI port settings, if needed.

- **To delete a surface, select it in the list and click Delete.**

- **You can turn off a surface by deactivating its “Use with Reason” checkbox.**

This could be useful if the surface is connected to your system but you only want to use it with another program.

There is also the Sync tab in the Preferences. This is only used for External Control MIDI buses and for MIDI Clock Sync input. All hands-on MIDI control is set up on the Control Surfaces tab.

## Example Setups

There are several possible variables when it comes to what type of setup you are using. Please read on.

### A single MIDI keyboard with controls

With this setup, the keyboard is your master keyboard, which means it is always routed via the sequencer (it controls the device connected to the sequencer track with Master Keyboard Input). To control another device, you move the Master Keyboard Input (the keyboard symbol in the In column in the track list) to another sequencer track.

You can, however, use Remote Override to control parameters on other Reason devices (or global Reason functions such as transport).

## A basic MIDI keyboard and an additional control surface

The keyboard and the control surface should be connected to separate MIDI ports (or use separate USB connections). Here, the basic MIDI keyboard is your master keyboard - it is used for playing and recording via the sequencer. You can have the control surface follow the master keyboard - this lets you tweak the parameters of the device you are playing (just like in the example above).

You can also lock the control surface to another device in the rack - this lets you play one device while adjusting the parameters of another.

## A MIDI keyboard with controls plus one or more control surfaces

This is the ideal setup! Again, all keyboards and control surfaces should be connected to separate MIDI ports (or use separate USB connections). The master keyboard is routed via the sequencer track and you can use its controls to tweak the parameters of the device you are playing. The additional control surfaces could be locked to the Main Mixer or to different devices in the rack.

If you have additional MIDI keyboards locked to devices in the rack, you can also play and record on their corresponding sequencer tracks simultaneously. This is perfect if your band has several keyboard players who want to play and record their tracks simultaneously into Reason!

For example, if you lock a control surface to the Main Mixer, you will always have control over levels, pans and additional channel strip parameters - see [“Remote controlling the Main Mixer”](#) and [“Remote controlling multiple mixer channels”](#). You could also have dedicated controls for transport, Undo/Redo, sequencer track MIDI focus selection, etc.

## Remote basics

Parameters and functions for each Reason device are mapped to controls on supported control surface devices. As soon as you have added your control surface(s) in the Preferences, you can start tweaking parameters!

- **By default, all connected control surfaces follow the sequencer’s current Master Keyboard Input.**  
This means that you set Master Keyboard Input to a track in the sequencer to route the control surface(s) to the track’s device in the rack. You can bypass this functionality by locking a control surface to a specific device - see [“Locking a surface to a device”](#). Or you can simply use Remote Override mapping (see [“Remote Override”](#) for specific parameters - these will then be mapped to the selected controls regardless of Master Keyboard Input.
- **The Reason device associated with the track with Master Keyboard Input will have its parameters standard mapped to logical controls (faders, buttons etc.) on the control surface device.**  
E.g. if a Subtractor has Master Keyboard Input, your control surface will control the most important Subtractor parameters. If you set Master Keyboard Input to a track connected to an NN-XT, the control surface will now control parameters on the NN-XT device, and so on for each device. There are standard mapping variations for most devices as well - see [“About mapping variations”](#).
- ! **Please refer to the separate “Control Surface Details” pdf document for device related information.**
- **Supported control surfaces with dedicated transport controls will be standard mapped to the equivalent transport controls in Reason.**  
If you do not have transport controls on your control surface you can still map transport controls to controllers using Remote Override mapping - see [“Remote Override mapping”](#).
- **Other important functions such as switching target track in the sequencer, selecting patches, Undo/Redo can also be remote controlled.**  
See [“Additional Remote Overrides...”](#).



## About Standard vs Remote Override mapping

Reason parameters are “standard-mapped” to supported control surface devices. There is nothing the user needs to set up to remote control any Reason device. You can, however, use Remote Override mapping to map a specific parameter to a specific control if you should want to.

- **By using standard mapping, the remote mapping for each device will be the same for any new song created in Reason, given you have the same set of control surfaces connected.**

If you use Remote Override mapping (see “[Remote Override](#)”), the overrides will be saved with the current song, but won’t be there if you create a new song.

- **Which parameters and functions that are standard mapped for each Reason device depends on the control surface(s).**

The “Control Surface Details” document contains some information about the standard mappings of the different control surface models. But you can also activate Remote Override Edit mode to see which parameters for each device are mapped to your control surface(s) - see “[Remote Override](#)”.

- **Note that if you have several control surfaces connected, some parameters could be mapped to controls on more than one control surface.**

This is not a conflict of any kind, but simply a consequence that stems from the fact that all control surfaces by default follow Master Keyboard Input. By using Surface Locking (see below) or Remote Override (see “[Remote Override](#)”) you have full control over your control surfaces.

## About mapping variations

Since there are often more parameters on a device than there are controls on the control surface, there are standard mapping variations available for most devices. When selecting a standard mapping variation, a new set of parameters will be mapped to the controls on your control surface for a selected Reason device.

For example, if you have a control surface with 8 rotary knobs routed to a Subtractor, the knobs may control filter parameters by default. Selecting variation 2 may make the knobs control the oscillator settings, variation 3 may control LFOs and so on.

- **For devices that support keyboard shortcuts, you switch between mapping variations by holding down [Ctrl]+[Alt](Win) or [Cmd]+[Option](Mac) and press the numerical keys [1] to [10] (not the numerical keypad), where [1] selects the default standard mapping.**

How many mapping variations are available depends on the control surface and the Reason device selected. The variation selected will stay active until you switch MIDI input to another device (or select another variation). If you switch back to the same device it will have its default standard mapping (variation [1]).

- **For control surfaces that have dedicated controls for selecting mapping variations these are used instead of keyboard shortcuts.**
- **Locked devices (see “[Locking a surface to a device](#)”) can also be locked to a specific mapping variation.**

# Locking a surface to a device

You can lock a control surface or an additional MIDI keyboard/controller to a specific device so that it is always “tweakable” and record enabled, regardless of which track has Master Keyboard input in the sequencer. This enables you to play and record notes for several devices simultaneously from multiple control surfaces/keyboards.

For example, you could lock a control surface to control the Main Mixer, so you can always control overall levels while playing/tweaking other devices. See “Remote controlling the Main Mixer” for an example.

- **The master keyboard device cannot be locked!**

If you select the master keyboard in the Preferences, you can click the “Use No Master Keyboard” button. You can then lock this control surface to a device and use its controllers to tweak parameters, but you will not be able to play the device.

- **You can lock several control surfaces to the same device.**

However, each control surface can only be locked to one device at a time.

- **Info about which devices are locked (and to which control surfaces) is saved with the song.**

## Locking a surface

There are basically two methods you can use to lock a Surface:

### Using the Surface Locking dialog

1. **Select “Surface Locking...” from the Options menu.**

The Surface Locking dialog opens.

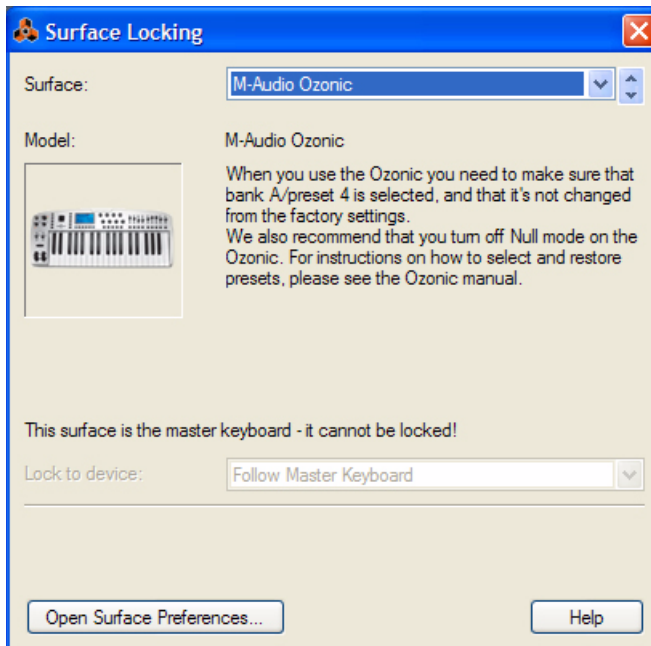

*In this picture, the dialog has the master keyboard as the selected control surface - this cannot be locked.*

2. Pull down the Surface pop-up from at the top of the dialog and select the control surface you wish to lock to a device.

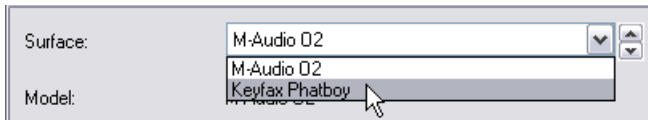

3. Next, open the “Lock to device” pop-up menu.

On this pop-up, all devices in the current song are listed. The “Follow Master Keyboard” item which is selected by default, means that the control surface isn’t locked (it instead follows the Master Keyboard Input in the sequencer).

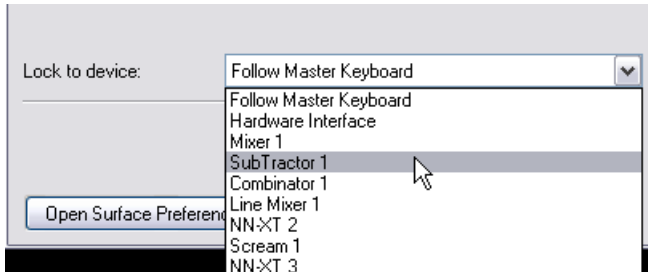

4. Select the device you wish to lock to the selected control surface from the list.

- If the selected control surface supports keyboard shortcuts for selecting mapping variations (see “About mapping variations”) an additional “Always use Mapping” pop-up appears.

On this pop-up you can set whether you wish to lock a specific standard mapping variation or whether the device should switch mapping variations according to keyboard shortcuts. If the former is the case, select the mapping variation from the list. If the latter is the case, select “Follow Keyboard Shortcut”.

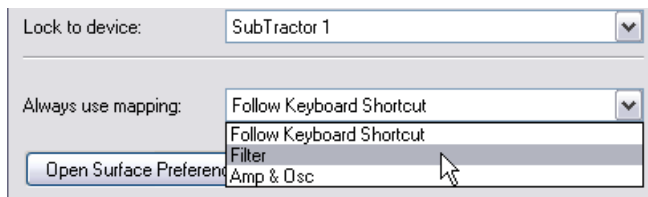

5. Close the dialog when you are done.

The device is now locked to the selected control surface. In Remote Override Edit mode (see “Activating Remote Override Edit mode”) a locked device is shown with a lock symbol in the upper left corner of the device panel.



- It’s also possible to lock a control surface to the ReGroove Mixer (see “The ReGroove Mixer”) to control its parameters via Remote!

## Using the context menu

- **A quick way to lock devices is by right-clicking (Win) or [Ctrl]-clicking (Mac) on a device panel to bring up the context menu.**

On the context menu, all installed control surfaces (apart from the master keyboard) are listed with the text “Lock to” plus the name of the control surface. Selecting one will lock the device to the control surface. On the context menu the control surface that is currently locked to this device will be ticked.

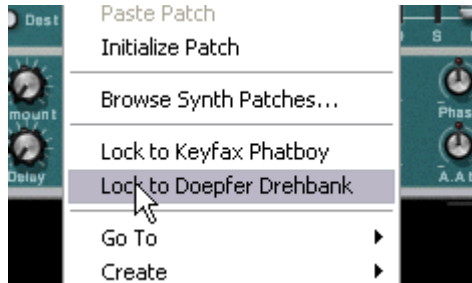

## Unlocking a surface

- **To unlock a locked device, bring up the context menu for the locked device, and untick the “Lock to” item.** This unlocks the device and the control surface will now follow master keyboard input.
- **Another way to unlock a surface is to open the Surface Locking dialog and selecting “Follow Master Keyboard” on the Lock to device pop-up.**

# Remote Override

Remote Override allows you to map parameters and functions to controls on your control surface device, overriding the standard mapping.

## Activating Remote Override Edit mode

### 1. Select “Remote Override Edit Mode” from the Options menu.

All unselected devices in the rack are grayed out, indicating Edit mode. Each selected device (including the Transport panel) will show a blue arrow symbol on every parameter that can be mapped to a control on a control surface.



Remote Override Edit mode enabled with the mixer device selected.

To be able to see which parameters are currently mapped for a device, you have to direct Master Keyboard input to the sequencer track it is connected to:

### 2. Select a device in the rack and enable Master Keyboard input for its sequencer track.

Standard-mapped parameters are tagged with yellow knob symbols.



A Subtractor with standard-mapped parameters.

→ **Note that you can select the Transport Panel as well!**

Most items on the Transport panel can be mapped to controls. Note that by selecting the Transport panel any standard mapping will be shown automatically, unlike other devices where you have to first direct Master Keyboard input to the device from the sequencer.

→ **If you point on a standard mapped parameter, a tooltip appears showing which control on the control surface device the parameter is mapped to.**

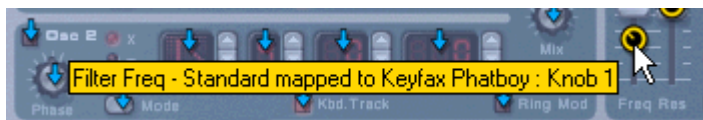

## Remote Override mapping

If Remote Override Edit Mode is enabled you can use the following methods to map a parameter to a control:

### Method 1:

**1. Select the parameter you wish to map.**

The arrow (or knob) changes to orange, indicating it is selected.

**2. Select “Edit Remote Override Mapping...” from the Edit menu.**

You can also right-click (Win) or [Ctrl]-click (Mac) on the parameter to select the same item from the context menu.

The “Edit Remote Override Mapping” dialog opens. From here you have two ways to proceed:

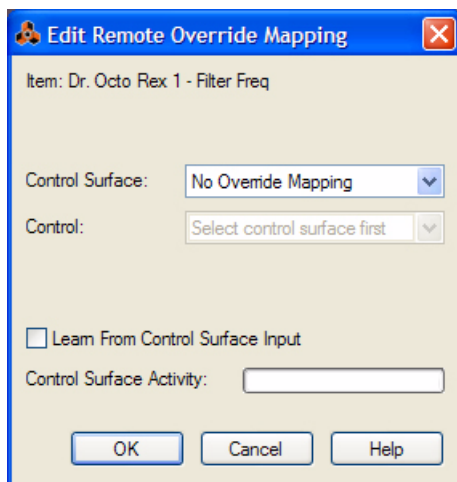

→ **Either manually select the control surface and the control you wish to map the parameter to from the two corresponding pop-ups.**

The Control Surface pop-up lists all installed control surface devices, and the Controls pop-up lists all the mappable controls for the selected control surface.

→ **Or you can activate “Learn From Control Surface Input” and simply move (or press) the control you want to map the parameter to.**

The “Control Surface Activity” field momentarily flickers as you turn the knob, and then the dialog shows the control surface and control it is mapped to.

→ **If the control surface has a keyboard, you can also select keys as controls.**

Keys work just like on/off buttons. If “Keyboard” is selected from the Controls pop-up, a Note Number field appears in the dialog.

### 3. Click OK to exit the dialog.

The mapped parameter now shows a lightning bolt icon, indicating it uses Remote Override mapping. Any overrides are always shown in Remote Override Edit mode. The device does not have to be selected or have Master Keyboard Input in the sequencer.



### 4. To exit Remote Override Edit Mode, deselect it from the Options menu.

You can also leave this mode by pressing [Esc].

## Method 2:

#### 1. Double-click the parameter you wish to map.

A rotating lightning bolt appears for the parameter - this indicates that “Learn From Control Surface” mode is active. You can leave this mode by pressing [Esc].

#### 2. Now move (or press) the control you want to map the parameter to.

The parameter is now mapped to the control.

You do not always have to edit override mapping when Remote Override Edit mode is activated - see below.

## Override mapping with Remote Override Edit mode deactivated

If Remote Override Edit Mode is enabled on the Options menu, mapped parameters are “tagged”, and the arrow indicators show the assignable parameters. In this mode, however, you cannot operate Reason normally. Remote Override Edit mode is primarily for overview of available parameters and the current assignments.

#### → Another way to map parameters is to have “Remote Override Edit Mode” deactivated on the Options menu, and to simply right-click (PC) or [Ctrl]-click (Mac) on the parameter you wish to remote control.

This opens a pop-up menu, where one of the options will be “Edit Remote Override Mapping”. Selecting this will open the Edit Remote Override Mapping dialog. Thus, you do not have to select Edit mode from the Options menu if you already know that a parameter is free and assignable.

## Removing Remote Overrides

This can be done for a selected parameter in the following way:

- 1. In Remote Override Edit Mode, select the parameter you wish to remove Remote Override for.**

The lightning bolt changes to orange, indicating it is selected.

- 2. Select “Clear Remote Override Mapping...” from the Edit menu.**

You can also right-click (Win) or [Ctrl]-click (Mac) on the parameter to select the same item from the context menu. This is always available, regardless whether Remote Override Edit mode is selected or not.

Or you can remove all Remote Overrides for a device in one go:

- 1. Select the device you wish to remove Remote Override for.**

- 2. Select “Clear All Remote Override Mappings for Device” from the Edit menu.**

You can also right-click (Win) or [Ctrl]-click (Mac) on the device panel to select the same item from the context menu.

## Copying/Pasting Remote Overrides

You can copy Remote Override mappings for a device and paste them into a device of the same type. This works as follows:

- 1. With Remote Override Edit mode activated, select the device you want copy Remote Override mappings from, and the select “Copy Remote Override Mappings” from the Edit menu.**

You can also right-click (Win) or [Ctrl]-click (Mac) on the device panel to select the same item from the context menu.

- 2. Select the device you wish to paste the copied mappings to.**

It has to be the same type of device you copied from. In case you copied Remote Override mappings from the Transport panel you can thus only paste the mappings into another song document.

- 3. Select “Paste Remote Override Mappings” from the Edit menu.**

Now the following happens:

- **If you are pasting in the mappings into a device in the same song document, a dialog appears informing that the overrides are already used.**

You then have the choice of cancelling the operation, or to move the existing overrides to the new device.

- **If you are pasting into a device in another song, the copied Remote Override mappings are simply pasted.**

In this case, the original Remote Override mappings are not affected.



# Additional Remote Overrides...

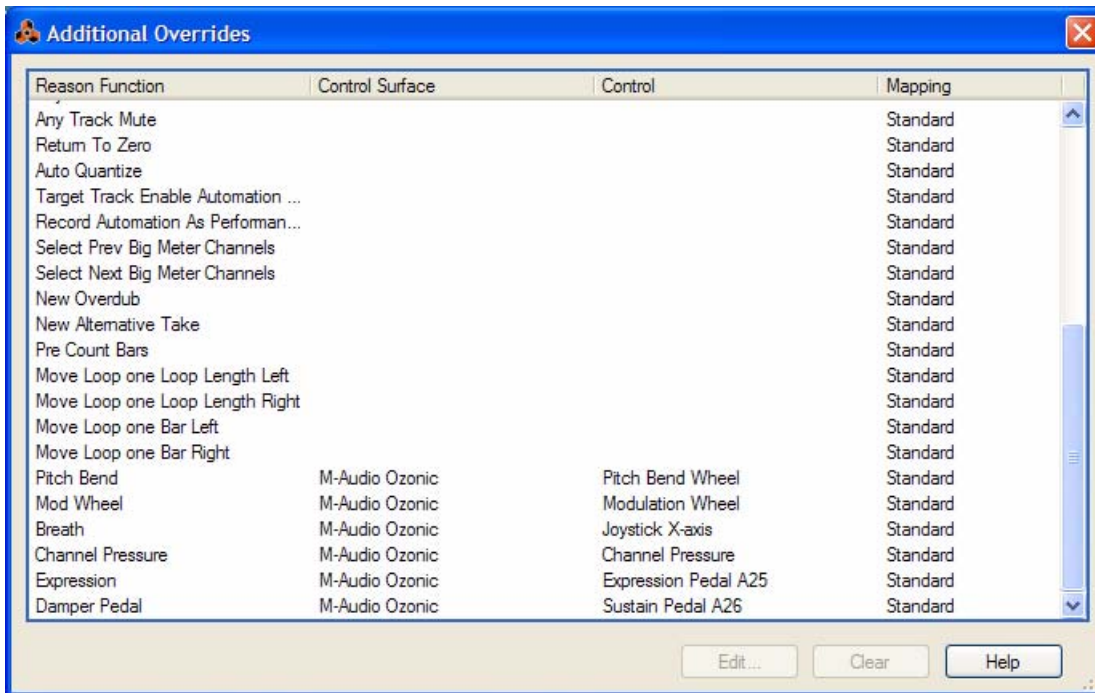

On the Options menu there is an item named “Additional Remote Overrides...”. Selecting this opens a dialog with remote functions that cannot be assigned using Remote Override Edit mode, such as switching target tracks, Undo/Redo etc.

Although most of the items in this dialog are self-explanatory, some need to be described. These are as follows:

## Target Track Delta and Target Previous/Next Track

- **Target track is the track with Master Keyboard Input.**  
Assigning Target Previous/Next Track to two Button controls on a control surface allows you to move the Master Keyboard Input symbol up or down in the Track list.
- **Target Track Delta is meant to be used with Delta wheel controllers (a special control with no min/max range) to switch target track.**  
A Mackie Jog wheel is an example of this type of controller.
- **Select Previous/Next Track can be assigned to standard button controls.**

## Select Patch for Target Device and Select Previous/Next Patch for Target Device

The target device is the device connected to the target track.

- **Patch selection is usually standard-mapped to buttons on a control surface.**  
If you wish to override this standard patch selection mapping for devices globally to select patches for any patch device that currently has Master Keyboard Input, you can assign this here.  
For example, you may always want to use the same buttons on a specific control surface for selecting patches.
- **Select Patch for Target Device is also meant to be assigned to a Delta-type control (see above).**  
This allows you to select patches for a device connected to the target track by spinning the wheel clockwise or anti-clockwise.
- **Select Previous/Next Patch can be assigned to standard button controls.**

## Select Keyboard Shortcut Variation (Delta)/Select Previous/Next Keyboard Shortcut Variation

By mapping controls to these, you can use your control surface to change which keyboard shortcut variation is selected in Reason.

- **The "Select Previous/Next" functions are typically mapped to buttons, allowing you to step between keyboard shortcut variations.**
- **The Delta function must be mapped to a delta-type control to work.**
- **The keyboard shortcut variation selection is a global setting in Reason. It affects all added control surfaces (if they make use of keyboard shortcut variations and aren't locked to a specific device and variation in the Surface Locking dialog).**

## Undo/Redo

You can assign Undo/Redo to controls. This works just like the corresponding items on the Edit menu.

## Document Name

This allows you show the name of the song in the display of the control surface. This only works for control surfaces that support this feature.

## Assigning Additional Overrides

Assigning overrides in this dialog is similar to assigning standard Remote Overrides:

1. **Select a function/parameter in the list that you wish to assign to a control and click "Edit".**

This opens the Edit Remote Override Mapping dialog, where you can assign a control to the selected function/parameter. You can also simply double click the item in the list to open this dialog.

2. **Click OK to close the dialog.**

## Clearing Additional Overrides

1. **Select "Additional Remote Overrides" from the Options menu.**

In the Mapping column you can see which parameters/functions use overrides.

2. **Select the item currently assigned override mapping, and click "Clear".**

# Keyboard Control

Assigning computer keyboard remote commands does not involve MIDI, so there is no special setting up required. Keyboard commands can be assigned to parameters just as when using Remote Override mapping, but the functionality differs in one central aspect:

- **Keyboard Control commands can only be used to toggle on/off or min/max values for an assigned parameter.**

Hence, if you assign a computer keyboard remote command for a knob, slider or spin control, it will only switch between the minimum and maximum values for that parameter. The only exception to this are the multi-selector buttons used for various parameters such as envelope destination, for example. These will cycle through the available options when using keyboard control.

- ! **Note that Keyboard Control cannot be used for the ReGroove Mixer parameters.**

## Enabling Keyboard Control

To enable Keyboard Control, select “Enable Keyboard Control” from the Options menu.

## Editing Keyboard Control

- **To get an overview of which parameters are remote controllable select “Keyboard Control Edit Mode” from the Options menu.**

When done, each device you select in the rack will show a yellow arrow symbol beside every parameter that can be assigned a keyboard control.



*A section of a Redrum drum machine with Keyboard Control Edit Mode enabled.*

- ! **The Main Mixer channel strip parameters can also be controlled using the Keyboard Control function, but there is no Edit Mode for this. Instead, you have to right-click (Win) or [Ctrl]-click (Mac) on individual channel strip parameters and select “Edit Keyboard Control Mapping” from the context menu.**

- **If you click on an assignable parameter to select it, you can then select “Edit Keyboard Control Mapping” from the Edit menu.**

This opens a dialog allowing you to select a key command for that parameter.

You may use any key except the [Space bar], [Tab], [Enter], the Numeric keypad keys (which is reserved for Transport functions) and the function keys (except [F2] and [F3]) - or a combination of [Shift] + any key (with the same aforementioned exceptions).

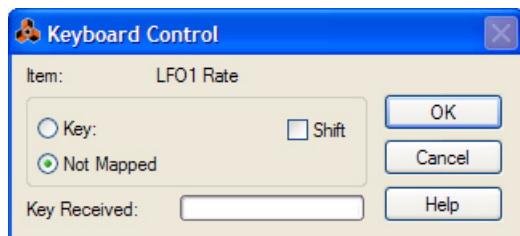

*The Keyboard Control dialog.*

- **Simply press the key (or Shift-key combination) you wish to use to remote control the parameter.**  
The “Key Received” field momentarily indicates that it is “learning” the keystroke(s), and then the dialog displays the name of the key you have pressed. If [Shift] was used, the box beside the word Shift in the dialog is ticked.

You can also double-click on the arrow for an assignable parameter to set up keyboard control:

- **A rotating yellow rectangle appears, indicating Learn mode. Press the key (or key combination) you wish to use to control the parameter.**

The rotating stops and the rectangle will now display the key or key combination you used.

## About the two Edit Keyboard Control Modes

If Keyboard Control Edit Mode is enabled (ticked) on the Options menu, assigned parameters in the rack are “tagged”, showing the remote key for that parameter. In this mode, however, you cannot operate Reason normally. This mode is primarily for overview of available parameters and the current assignments.

- **Another way to assign keyboard remote commands is to have “Keyboard Control Edit Mode” deselected on the Options menu, and to simply right-click (Win) or [Ctrl]-click (Mac) the parameter you wish to remote control.**

This opens a pop-up menu, where one of the options will be “Edit Keyboard Control Mapping”. Selecting this opens the Keyboard Control dialog. Thus, you do not have to enable/disable Edit mode from the Options menu if you know that a parameter is assignable.

- ! **This is the only way Main Mixer channel strip parameters can be assigned to Keyboard Control.**

## Saving Remote Setups

There’s no need to save MIDI Remote mapping as the Standard Remote mapping for each Reason device to supported control surfaces is built-in, and is always available. You may, however, wish to save specific Remote Override mappings or Keyboard Control setups as a template:

- **This could be done by saving a song document containing all the devices that are affected by the related Key or Remote Override mappings, but without any sequencer data.**

This song document could then be used as a starting point for any new song, by simply loading it, and immediately using “Save As” to save it under a new name.

- **A good idea could be to save these types of “Remote Template” songs in the Template Songs folder. See “Making a Song appear as a Template Song” for info on how to do this.**

# **Chapter 21**

## **ReWire**

## About this chapter

This chapter describes how to use Reason as a ReWire slave; that is with Reason delivering audio to another ReWire compatible application. Using ReBirth and Reason together is described in ["ReBirth Input Machine"](#).

## Why use Reason with ReWire?

While Reason is a complete music tool in its own right, you might want to use other elements in your music, such as special software synthesizers and effect plug-ins.

Connecting Reason to another application allows you to integrate your Reason devices and songs with other type of music and recordings, etc. By recording Reason tracks onto audio tracks in another audio sequencer, you can also continue processing your Reason tracks with other software plug-ins.

## Introducing ReWire!

To make this integration between two audio programs possible, Propellerhead Software has developed ReWire. This technology provides the following possibilities and features:

### In ReWire version 1

- **Real time streaming of separate audio channels, at full bandwidth, into another audio program.**
- **Automatic, sample accurate, synchronization between the audio in the two programs.**
- **The possibility to have the two programs share one audio card.**
- **Linked transport controls that allows you to play, rewind etc., from either program.**
- **Less total system requirements than when using the programs together in the conventional way.**

### In ReWire 2

A number of features were added in ReWire version 2. The following are the most important:

- **Up to 256 audio channels (previously 64).**
- **Bi-directional MIDI communication of up to 4080 MIDI channels (255 devices with 16 channels each)**
- **Automatic querying and linking features that (among other things) allow a host to display the slave's devices, controllers, drum sounds etc. by name.**

## How does it work?

Basically the key to ReWire is the fact that Reason is divided into three components:

- **The Reason application.**
- **The Reason Engine (a DLL on the PC and a Shared Library file on the Macintosh. Both located in the Reason program folder.)**
- **ReWire (also a DLL on the PC and a Shared Library on the Macintosh).**

ReWire and the Reason Engine are common resources to the two programs (the other application and Reason) that generate the audio and passes it onto the other audio application.

## Terminology

In this text we refer to Reason as a ReWire slave and the application receiving audio from Reason (this could be Steinberg Cubase, Apple Logic Audio or MOTU Digital Performer, for example) as the host application.

## About system requirements

To run Reason together with another audio application of course raises the demands on computing power. However, adding ReWire to the equation does not in itself require a more powerful computer. On the contrary, it is likely that ReWiring two programs requires less power than, for example, running them with one audio card each.

Still, you should be aware that running two powerful audio applications on one computer will require a fast processor and most of all a healthy amount of RAM.

## About synchronization

When using ReWire all synchronization to other equipment is handled from the host application - not in Reason. In fact there are no special synchronization issues. All that is said in the host application's documentation about synchronizing audio channels is true for ReWire channels as well.

For information about MIDI Clock synchronization - without using ReWire - refer to ["Synchronization to MIDI Clock"](#).

## Launching and quitting applications

When using ReWire, the launch and quit order is very important:

### Launching for normal use with ReWire

1. **First launch the host application.**
2. **Then launch Reason.**

### Quitting a ReWire session

When you are finished, you also need to quit the applications in a special order:

1. **First quit Reason.**
2. **Then quit the host application.**

### Launching the host application for use without Reason/ReWire

If you don't plan to run Reason, just launch the host application as usual. We recommend that you then also deactivate all ReWire channels if required (see the relevant section for your program, below). But this is not completely critical; ReWire does not use up very much processing power when it isn't used.

### Launching Reason for use without the host application

If you want to use Reason as is, without ReWire, just launch it as you normally do.

### Launching both programs without using ReWire

We don't know exactly why you would want to run Reason and a Rewire host application at the same time on the same computer, without using ReWire, but you can:

**1. First launch Reason.**

**2. Then launch the host application.**

You may get a warning message in the host application, regarding ReWire, but you can safely ignore it. Please also note that the two programs now compete for system resources such as audio cards, just as when running either with other, non-ReWire, audio applications.

## Using the Transport and Tempo controls

### Basic Transport controls

When you run ReWire, the transports in the two programs are completely linked. It doesn't matter in which program you Play, Stop, Fast Forward or Rewind. Recording, however, is still completely separate in the two applications.

**! When you run Reason as a ReWire slave, it's not possible to record on audio tracks in Reason.**

### Loop settings

The Loop in Reason and the corresponding feature (Loop, Cycle etc.) in the host application are also linked. This means that you can move the start and end point for the Loop/Cycle or turn the Loop/Cycle on/off in either program, and this will be reflected in the other.

### Tempo settings

As far as tempo goes, the host application is always the Master. This means that both program will run in the tempo set in the host application. However, if you are not using automated tempo changes in the host application, you can adjust the tempo on the transport in either program, and this will immediately be reflected in the other application.

**! If you are using automated tempo changes in the host application, do not adjust the tempo on the Reason Transport Panel, since that tempo the doesn't have any effect on playback!**

**! If you are using automated tempo changes in the host application, or change the Tempo in the host application, Reason will not use high-quality stretching of audio tracks!**

## Routing audio

### Preparations in Reason

When you route audio from Reason to a ReWire host application, you make use of the Reason Hardware Interface at the top of the rack. Basically, each output in the Hardware Interface is connected to a separate ReWire channel.

- **To take full advantage of the mixing features in the host application you need to connect the different Reason Mix Channel and/or Audio Track devices directly to the Hardware Interface (see [“Using the Mix Channel and Audio Track devices’ Direct Outs”](#)).**

For example, if your Reason Song contains eight different instrument devices and you connect these, either directly or via their Mix Channel devices, to separate audio outputs on the Hardware Interface, they will appear on separate ReWire channels in the host application. You can then use the mixing facilities in the host application to adjust volume and pan, add effects and equalizing etc. - individually for each Reason device.

If you instead connect all your Reason devices via the Main Mixer to the stereo input pair on the Hardware Interface, all sounds will appear mixed on a single ReWire stereo channel pair. While this works perfectly fine, you won't be able to mix and process the devices separately in the host application.



## Routing in the ReWire host application

The following description is based on using Reason with Cubase as the host application. For descriptions on how to activate and route ReWire channels in other host applications, please go to [www.propellerheads.se/rewirehelp](http://www.propellerheads.se/rewirehelp).

- 1. Pull down the Devices menu in Cubase and select the menu item with the name of the ReWire application (in this case Reason). All recognized ReWire compatible applications will be available on the Devices menu.**  
The ReWire panel appears. This consists of a number of rows, one for each available ReWire channel.
- 2. Click on the green buttons in the “Active” column to activate/deactivate the desired channels.**  
The buttons light up to indicate activated channels. How many and what channels you need to activate depends on to which Hardware Interface inputs you have connected your Reason devices, as discussed above.
- 3. If desired, double click on the labels in the right column, and type in another name.**  
These labels will be used in the Cubase Mixer to identify the ReWire channels.
- 4. Open the Cubase Mixer.**  
You will find that new channels have been added - one for each activated ReWire channel. If the channels aren't visible, you may need to scroll the Mixer window or check the Mixer View options (different channel types can be shown or hidden as desired in the Cubase Mixer).
- 5. Start playback (in Reason or Cubase - it doesn't matter as both programs will automatically be synchronized).**  
You will now see the level meters moving for the playing ReWire channel, and hear the sound of the Reason devices through Cubase's Mixer. Of course, this requires that your Reason Song contains some music!
- 6. Use the mixing features in Cubase to add effects, EQ, etc.**

## Routing MIDI via ReWire 2

The following description is based on using Reason with Cubase as the host application. For descriptions on how to route MIDI to Reason and Reason from other host applications, please go to [www.propellerheads.se/rewirehelp](http://www.propellerheads.se/rewirehelp).

- 1. In Cubase, select a MIDI track that you want to route to a Reason device.**
- 2. Pull down the MIDI Output menu for the track (in the Inspector or track list).**  
All devices in the current Reason Song are listed on the pop-up menu, along with the conventional, “physical” MIDI outputs.
- 3. Select a Reason device from the pop-up menu.**  
The output of the MIDI track is now routed to that device.
- If you now play back a MIDI part on the track, the MIDI notes will be sent to the Reason device - just as if the track were connected to any regular MIDI sound source.**  
The sound of the device will be sent back into Cubase via ReWire - which channel it will appear on depends on how you have routed the device to the Hardware Interface in Reason, as discussed above.
- To play the device “live”, you need to select the proper MIDI input for the track in Cubase (the input to which your MIDI keyboard is connected) and activate the Monitor button for the track.**  
When the Monitor button is activated, all incoming MIDI (i.e. what you play on the keyboard) is immediately sent to the track's MIDI Output (i.e. to the Reason device).

# Converting ReWire channels to audio tracks

Most often, there is no need to convert individual ReWire channels to regular audio tracks. The channels already appear in the host application's Mixer, and you can typically perform the same kind of real-time processing as with regular audio channels (effects, EQ, volume, pan and mute automation, etc.).

Still, you may need to convert the ReWire channels to audio tracks, for example if you want to continue working in Cubase only. This is probably easiest done by using Reason's internal "Bounce Mixer Channels" function, described in "[Bouncing Mixer Channels](#)". When you have bounced the desired Mixer Channels, you could then import the generated audio files to tracks in the host application for further processing.

Alternatively, you could use the host application's "Export Audio" or "Bounce" function. In Cubase, you would proceed as follows:

- 1. Make sure your Reason devices and/or audio tracks play back properly via ReWire.**
  - 2. In the Cubase Mixer, activate Solo for the ReWire channel you want to convert to a regular audio track.**  
Make sure no other channel is Soloed.
  - 3. Go to Cubase's Project window and set the left and right locator to encompass the whole song (or a section, if that's what you want).**  
Make sure the Cycle (loop) function is turned off.
  - 4. Pull down the File menu in Cubase and select "Audio Mixdown" from the Export submenu.**  
The Export Audio Mixdown dialog appears.
  - 5. Activate the "Import to Pool" and "Import to Track" options and fill in the rest of the dialog as desired.**  
You can choose to include any Cubase mixer automation, select a file format and file name, etc.
  - 6. Click Save.**  
The ReWire channel is now rendered to a new audio file on disk. A clip referring to the file will appear in the Pool, and an audio event playing this clip will be created and placed on a new audio track, starting at the left locator.
- **If you now play back the audio track you will hear exactly what was played on the ReWire channel.**  
This means you should keep that ReWire channel muted (or deactivated) now, since otherwise you would hear the sound twice - once via ReWire and once from the audio track.
- **To convert all your ReWire channels this way, simply proceed as above (but solo another ReWire channel in the Cubase Mixer).**
- ! **Converting ReWire channels this way results in a number of audio files that can be very large (depending on the length of the song). Make sure you have enough disk space!**

## Details about various ReWire hosts

The Propellerhead Software web site provides updated information on how to configure ReWire for most compatible host applications.

Please go to: [www.propellerheads.se/rewirehelp](http://www.propellerheads.se/rewirehelp).

# **Chapter 22**

## **Synchronization and Advanced MIDI**

## About this chapter

This chapter describes how to synchronize Reason to external MIDI Clock and how to sync external equipment from Reason's internal MIDI Clock. The chapter also describes how to use the External Control Bus inputs for advanced MIDI routing when you're not using ReWire.

## Synchronization to MIDI Clock

### ReWire users – read this!

This section is about synchronization via MIDI Clock, and does not apply to users of ReWire. If you are using Reason together with a ReWire compatible application, ReWire automatically handles all synchronization issues for you. See [“About synchronization”](#) for details.

### What is synchronization and MIDI Clock?

Synchronization, in this context, is when you make Reason play at the same tempo as another MIDI device; where both start, stop and can locate to certain positions, together. This is done by transmitting MIDI Clock signals between Reason and the other device. MIDI Clock is a very fast “metronome” that can be transmitted in a MIDI cable. As part of the MIDI Clock concept there are also instructions for Start, Stop and locating to sixteenth note positions.

You can set up synchronization between Reason and hardware devices (tape recorders, drum machines, stand alone sequencers, workstations etc.) and other computer programs running on the same or on another computer.

### Master/Slave

In a synchronized system there is always one master and one or more slaves. In our case, the master is the one that controls the tempo. In other words, it is only the tempo setting on the master device that is of any relevance, since the slaves slavishly follow the master's tempo.

- Reason can act as master or slave. That is, Reason can transmit MIDI Clock signals and also receive them.

### Using Reason as MIDI Clock master

Reason can transmit standard MIDI Clock signal. It also sends Start, Stop, Continue and Song Position Pointer (SPP) MIDI messages so that you can also control the transport functions of the slaved equipment from the Transport Panel in Reason. To set up Reason as a MIDI Clock master, proceed as follows:

1. Select the desired MIDI Port from the Output drop-down menu in the “MIDI clock sync” section on the Sync tab in Preferences.

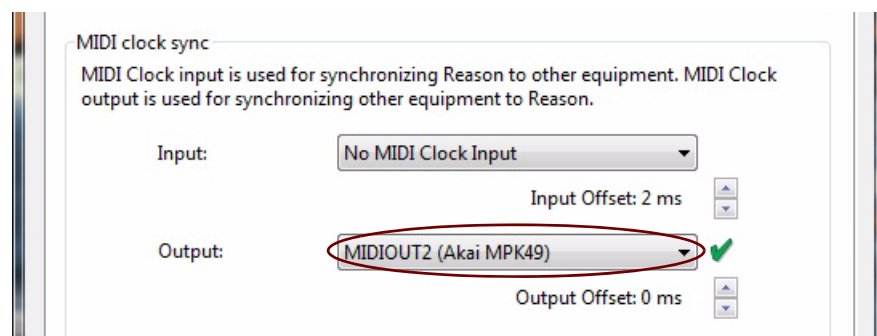

Selecting MIDI clock output port.

2. Close the Preferences window.

3. Select “Sync -> Send MIDI Clock” from the Options menu.

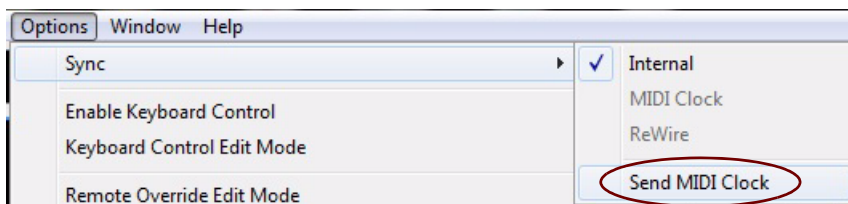

Now, you have set up Reason as a MIDI Clock sync master. When you start the Reason sequencer, MIDI Clock is sent out on the selected MIDI Out Port.

→ If your synced MIDI equipment is not in phase with the Reason sequencer, you might have to change the Output Offset in the “MIDI clock sync” section on the Sync tab in Preferences.

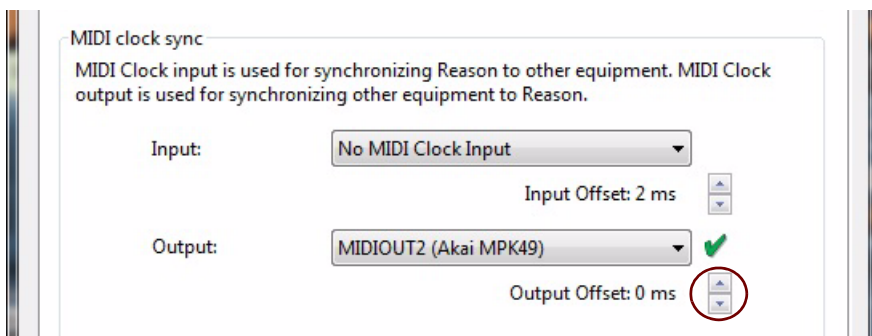

→ If the external MIDI equipment lags, set the Output Offset to a negative value.

A negative Output Offset means that the MIDI Clock signal is sent out from Reason earlier to compensate for the lag.

→ If the external MIDI equipment plays ahead of the Reason sequencer, set the Output Offset to a positive value.

There are also some additional options regarding the MIDI Clock signal that can be selected at the bottom of the MIDI clock sync section:

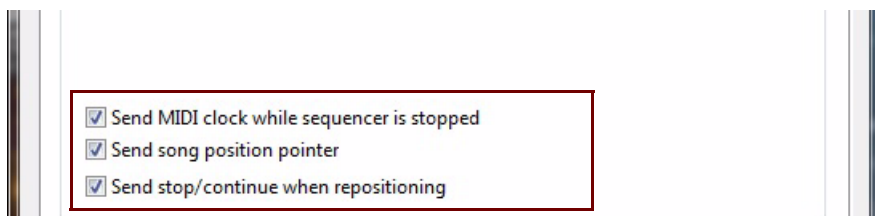

• **Send MIDI clock while sequencer is stopped.**

When this box is checked, Reason continues to send out MIDI clock signal also when the sequencer is stopped.

• **Send song position pointer.**

When this box is checked, Reason sends out MIDI Song Position Pointer information to the slaved device. If the sync slave device doesn't support Song Position Pointer, turning this setting off can improve synchronization. This is also useful if the sync slave is playing a looped pattern and should disregard all positioning.

• **Send stop/continue when repositioning.**

When this box is checked, Reason sends out Stop/Song Position Pointer/Continue messages to the slaved device if the song position locator in the sequencer is moved (either manually or when in Loop mode) when the sequencer is running.

If unchecked, only Song Position Pointer messages are sent out if the song position locator is moved (or in Loop mode) while the sequencer is running.

## Slaving Reason to an external MIDI application or instrument

This example assumes that you have an external device, such as a drum machine, hardware sequencer, another computer, tape recorder etc., that transmits MIDI Clock signals to which you want to synchronize Reason.

1. **Connect the device via USB/MIDI to the computer running Reason.**
2. **Set up the other device so that it transmits MIDI Clock signals to the MIDI Out you just connected to the computer running Reason.**
3. **In Reason, pull down the Edit menu (under Mac OS X, the Reason menu) and open the Preferences dialog. Click the Sync tab.**

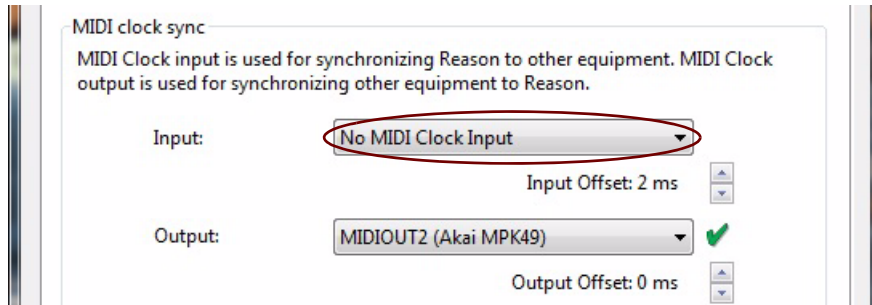

4. **Pull down the MIDI Clock Input pop-up and select the MIDI Input to which you connected the other device.**
  5. **Close the dialog.**
  6. **Activate MIDI Clock Sync from the Options menu - “Sync” submenu in Reason.**
  7. **Activate playback on the other device.**  
Reason will start playing in sync with it.
- **If the Reason sequencer lags or plays ahead of the master device, adjust the Input Offset on the Sync page in Preferences, see “Adjusting for Latency”.**

## Slaving Reason to another program on the same computer

! **The preferred method for synchronizing two applications is by using ReWire, see “ReWire”. However, if the application you need to sync Reason with doesn’t support ReWire, you can try the procedures described below.**

This section describes how to use MIDI Clock to synchronize Reason to another application running on the same computer.

! **Note that synchronization via MIDI Clock makes the two programs play at the same time, that is, they both “run” when you “hit play”. It does not mean they can both play audio at the same time.**

Proceed as follows:

1. **Set up the other program, so that it transmits MIDI Clock to Reason:**  
Under Windows this is done by selecting one of the MIDI routing utility ports.
  2. **In Reason, open the Preferences - Sync page.**
  3. **Pull down the MIDI Clock Input pop-up and select the corresponding MIDI port.**
  4. **Close the dialog.**
  5. **Activate MIDI Clock Sync from the Options menu - “Sync” submenu in Reason.**
  6. **Activate playback on the other device.**  
Reason will start playing in sync with it.
- **If the Reason sequencer lags or plays ahead of the master device, adjust the Input Offset on the Sync page in Preferences, see “Adjusting for Latency”.**

# External synchronization considerations

## Adjusting for Latency

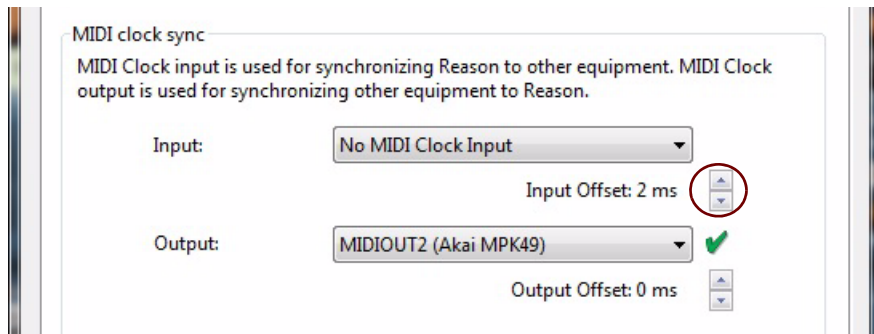

Because of the MIDI latency problem described in “[ReWire and Latency](#)”, you might need to adjust Reason's playback in relation to the sync master, so that they are in perfect time. The tempo will not differ between the two, but Reason might play ahead or behind the other application. You might need to adjust this. However, this is something you only need to do once. The setting is stored with your other preferences, so you don't need to adjust it again.

Proceed as follows:

- 1. Set up the other application so that it generates a solid click, on for example quarter or eighth notes, preferably with a special sound on the downbeat.**  
This click can either come from an internal metronome or from a MIDI source. If you use a MIDI source, make sure you pick one that has solid MIDI timing.
- 2. Set up Reason so that it plays a similar rhythm as the other application.**  
You might for example use the sequencer Click or a Redrum drum computer for this.
- 3. Start the two applications in sync.**
- 4. Make sure you hear both applications at approximately equal level.**
- 5. Open the Preferences dialog in Reason and click the Sync tab.**
- 6. Trim the “Input Offset” setting until the “clicks” from the both sources sound at exactly the same time.**
- 7. Close the Preferences dialog in Reason.**

## If Latency Compensation isn't enough

There might be situations where you can't compensate enough in Reason to make two software applications run in sync. This might especially be true if the other application is an audio sequencer, that is if it can record and playback both audio and MIDI.

This problem is an indication of the fact that the other application has not been set up properly and that its audio playback is not in sync with its own MIDI playback.

- ! This is not something that you can or should compensate for in Reason. Instead, follow the instruction included with the other application to make sure its MIDI playback and audio playback are correctly locked to each other.**

## About the beginning of the Song

Due to the latency phenomenon, described in “[About latency](#)”, Reason needs some time to correct its playback speed when it first receives the Start command. This can be noted as a small glitch in the audio playback, when the program starts. If this is a problem, you need to insert a couple of empty measures at the beginning of the Song. Proceed as follows:

1. **Set the Left Locator to “1. 1. 1.0” and the right Locator to “3. 1. 1.0”.**
2. **Click somewhere in the main sequencer area to move the menu focus to the sequencer.**
3. **Select “Insert Bars Between Locators” from the Edit menu.**
4. **Set up the other device/application, so that it also plays two empty bars at the beginning.**

## About MIDI Song Position Pointers

MIDI Clock actually consists of five type of messages: The actual clock (the metronome that establishes the tempo), Start, Stop and Continue commands and Song Position Pointers. This last type of message contains information about positions, so that a program for example “knows” where in a Song to start playback from.

Normally, this ensures that you can locate to any position and activate playback from there. In older devices, Song Position Pointers might not be implemented. This means that you will be able to synchronize properly only if you start both devices from the absolute beginning of the song.

## About Tempo Changes

Again, due to the latency phenomenon, Reason needs a bit of time to adjust to changes in tempo. If there are abrupt changes in the MIDI Clock, due to drastic tempo changes in the master, you will note that Reason will require up to one measure to adjust itself to the change. How long this actually takes also depends on the precision of the incoming MIDI Clock. The more precise it is, the faster Reason can adjust to it.

If this adjustment is a problem, try to use gradual tempo changes rather than immediate ones.

**! When Reason is synchronized to MIDI Clock, there is no Tempo readout.**

## Input Focus and Play Focus

If you activate (external) MIDI Clock sync on the Options|Sync menu, the Transport Panel controls will be disabled, and Reason will not run unless MIDI Sync data is provided from an external device.

The Input Focus (MIDI + Audio) and Play Focus (MIDI Sync) buttons (located on the Reason Hardware Interface) relate to how incoming MIDI and MIDI sync should be handled if there are several open Song documents. If you have two or more Songs opened, and no MIDI sync is used, the currently selected Song (the document “on top”) always has Input focus.

If (external) MIDI Clock sync is enabled (which is global for all currently open Song documents), this functionality changes in the following way:

- **If both “Play Focus” and “Input Focus” are activated for a Song, incoming MIDI data, MIDI sync (and Audio) will be sent to this Song, regardless of whether another Song is currently in focus.**
- **If only “Input Focus” is activated for Song, and another Song has “Play Focus”, incoming MIDI (and Audio) will be sent to the former and MIDI sync to the latter (i.e this Song will play back), regardless of which Song is currently in focus.**



# Advanced MIDI - The External Control Bus inputs

## About the External Control Bus inputs

The External Control Bus inputs allow you to receive MIDI from external equipment/applications directly to Reason devices.

- **These MIDI inputs are for controlling Reason devices from an external sequencer.**  
This could be an external hardware sequencer or a sequencer application running on another computer.
- **If you want to control Reason from another sequencer application on the same computer, the preferred method is using ReWire (see “Routing MIDI via ReWire 2”).**  
However, if the other sequencer software doesn't support ReWire 2, the External Control Bus inputs can be an alternative. In that case, you may need to use a MIDI routing application to be able to route MIDI from one program to the other.

You set up the External Control Bus inputs on the Sync tab in the Preferences dialog:



- **Select a separate MIDI port for each bus you plan to use.**  
Each bus provides 16 MIDI channels, for a total of up to 64 MIDI input channels. For example, if you have an external sequencer with two MIDI outputs, you connect these to two MIDI inputs on your MIDI interface and select these two inputs for the first two busses on the Advanced MIDI page. You will then be able to send MIDI on up to 32 channels from the external sequencer to Reason.
- **Make sure you don't select a MIDI port that is already selected on the Control surfaces tab (or in the MIDI Clock Sync section).**
- **To control external MIDI equipment from Reason, you use the External MIDI Instrument device. Refer to “External MIDI Instrument” for more details.**

## Routing MIDI to devices

Each External Control Bus can control up to 16 different Reason devices, one for each MIDI channel. To route a MIDI channel directly to a Reason device, proceed as follows:

1. **Locate the Reason Hardware Interface at the top of the rack and click the **ADVANCED MIDI** button.**



The Advanced MIDI Device panel is unfolded.

2. **On the Advanced MIDI Device panel, click the **Bus Select** button for the External Control Bus you want to use (**A, B, C or D**).**



3. **Below the Bus Select buttons there are fields for the 16 MIDI channels. Click the arrow button for the desired MIDI channel and select a Reason device from the menu that appears.**

Incoming MIDI data on that bus and channel will now be sent directly to the selected device. In other words, the master keyboard routing in the sequencer is bypassed.

## Receiving Controller data via MIDI

It is possible to send controller data from an external sequencer to control Reason parameters. Just set up your external device to transmit the correct MIDI controller messages on the right MIDI port.

To find out which MIDI Controller number corresponds to which control on each device, please see the “MIDI Implementation Charts.pdf” document.

Once you have located the controller numbers and set everything up, you can record and edit the controller data in the external sequencer as you normally do, and the Reason parameters will react correspondingly.

- **Do not confuse this with Remote control. Remote does not require any mapping of controller numbers for supported control surfaces! See “About Remote”.**

## About recording Pattern Changes

As specified in the MIDI Implementation, MIDI Controller #3 can be used to switch patterns in a device. However, pattern changes activated this way occur immediately (not at the end of the bar), which may or may not be what you prefer.

Please, see “Recording pattern automation”, “Editing pattern automation” and “Drawing pattern automation” for information on recording and editing pattern changes.

# **Chapter 23**

## **Optimizing Performance**

# Introduction

Reason is a program of infinite possibilities. You can create extremely complex songs, with a vast number of audio tracks and rack devices. While this is one of the most exciting properties of the program, it does have a drawback – it means that you must be careful with how you manage your computer processing power.

Each audio track and device you add in your song uses up a bit of computer processing power – the more audio tracks and devices, the faster the computer has to be. However, you can set up your devices to require more or less processing power. For example, a sound on the Subtractor synthesizer that only uses one oscillator and one filter requires less processing power than one using both dual oscillators and dual filters.

Samples used in your songs also require RAM (memory) to load properly. The use of RAM can also be managed, as described at the end of this chapter.

When collaborating on songs with other Reason owners, you should do what you can to reduce the requirements for playing back a certain song, both in terms of processing power and in terms of RAM requirements. Other users may not have as powerful a computer as you do!

## Checking Processing Power

To the right on the Transport Panel you will find a meter labelled DSP. This indicates how much processing power is used at any given moment.



*The DSP meter on the Transport Panel*

The higher this meter goes, the higher the strain on your computer processor. You will note when your processor is heavily loaded that graphics will update slower. Finally, when there's too little power left to generate audio properly, the sound will start to break up.

## Optimization and latency reduction

As described in ["About latency"](#) in the Audio Basics chapter, you generally want the lowest possible latency, to get the best response when you record and play in Reason in real time. However, selecting too low a latency is likely to result in playback problems (clicks, pops, dropouts, etc.). There are several technical reasons for this, the main one being that with smaller buffers (lower latency), the average strain on the CPU will be higher. This also means that the more CPU-intensive your Reason song (i.e. the more devices and audio tracks you use), the higher the minimum latency required for avoiding playback difficulties.

Therefore, you may need to adjust the latency. This is done differently depending on which audio cards, drivers and operating system you are using.

### Making Buffer Size adjustments in the ASIO Control Panel (Windows)

If you are using an ASIO driver (Windows only) specifically written for the audio hardware, you can in most cases make settings for the hardware in its ASIO Control Panel. This panel (opened by clicking the ASIO Control Panel button in the Preferences-Audio dialog) may or may not contain parameters for adjusting the latency. Usually this is done by changing the number and/or size of the audio buffers - the fewer and smaller the audio buffers, the lower the latency. Please consult the documentation of your audio hardware and its ASIO drivers for details.

! Raising the buffer size to eliminate audio artefacts on playback is mainly effective if you are currently using very small buffers, 64 to 256 samples. If the buffers are already big (1024 or 2048 samples) you will not notice much difference.

## Making Buffer Size adjustments in the Reason Preferences dialog

If you are running Reason under Windows and are using an ASIO driver, or under Mac OS X and are using a Core Audio driver, you can adjust the input and output latencies in the Preferences – Audio dialog.

→ This is done by dragging the Buffer Size slider.

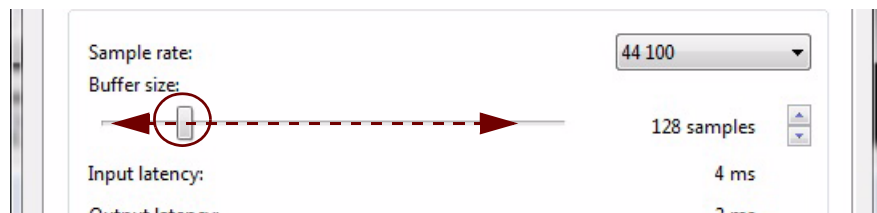

## General procedure for reducing latency

The basic procedure for optimizing the latency is the following:

### 1. Open a song and start playback.

You want to choose a song that is reasonably demanding, i.e. with more than just a few tracks and devices.

### 2. Open the Preferences dialog.

Under Mac OS X, this is found on the Reason menu; under Windows it's found on the Edit menu.

### 3. Click the Audio tab and locate the Buffer Size slider.

! If you are making adjustments in the ASIO Control Panel for hardware with an ASIO driver (Windows only), you should make a note of the current buffer settings before changing them.

### 4. While the song is playing, listen closely for pops and clicks and try lowering the latency (Buffer Size).

### 5. When you get pops and clicks, raise the Buffer Size value a bit.

### 6. Close the Preferences dialog (and ASIO Control Panel, if open).

## About Latency Compensation

Below the Input Latency and Output Latency rows in the Preferences-Audio dialog, you will find an item called Recording Latency Compensation. This value is used internally in Reason to compensate for latencies when recording audio using external monitoring.

## Recording Latency Compensation

! Adjusting the Recording Latency Compensation parameter is never necessary when you have selected "Automatic" in the Monitoring section on the Audio page in Preferences - see "Monitoring".

Recording Latency Compensation is when the program adjusts the position of the recorded audio according to the current latency. Here's how it works:

If you're recording audio and are not monitoring through Reason (e.g. monitoring directly through the audio card or via an external mixer), the audio you record will reach the program slightly late. This is because you play along with background tracks or the metronome - and you hear these delayed by the output latency. Also, the sound you record is sent to the program via the buffers in the audio hardware - it is delayed by the input latency.

Reason compensates for this by moving the recorded audio earlier by the sum of the input+output latencies. This compensation is also done in "Manual Monitoring" mode, if Monitor was Off for the recorded track (when you started recording).

If Monitor is On, there is no Recording Latency Compensation. This is because the monitored sound will also be delayed, and numerous tests have shown that the performer will actually play slightly ahead to compensate for this. In other words, when monitoring through Reason, the performer is expected to do the Recording Latency Compensation himself/herself.

If you are monitoring via an external mixer, and have selected "External" in the Monitoring section on the Audio tab in Preferences, there might be situations where you experience that the recorded audio is generally played back too early - or too late - in the song. This could be because your audio card doesn't actually have the latency values it reported to Reason.

If you should experience that your audio recordings are played back too early or too late compared to the instrument tracks in your song, you can adjust this by editing the Recording Latency Compensation parameter:

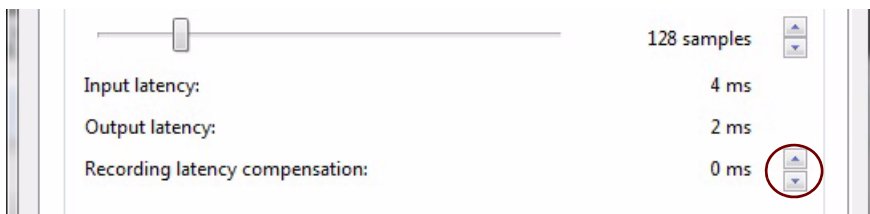

→ **Click the Recording Latency Compensation spin controls to compensate for early or late playback of audio track recordings**

If the audio appears too early during playback, adjust to a negative (-) value.

If the audio appears too late during playback, adjust to a positive value.

## Optimizing your computer system

In this manual we do not have the possibility to give you detailed procedures for optimizing your computer for maximum power. This is a subject that we could write complete books on. However, there are a couple of very useful things to check and adjust.

### About Multi-core processors

When you're using a multi-core processor, such as a dual-core or quad-core processor, Reason will take full advantage of this in a very sophisticated way. Similarly, if your computer has several multi-core processors, Reason will use the full capacity of these to vastly enhance the performance.

If your computer has one or several multi-core processors, Reason automatically detects this and automatically enables the "Use multi-core audio rendering" function on the General page in Preferences:

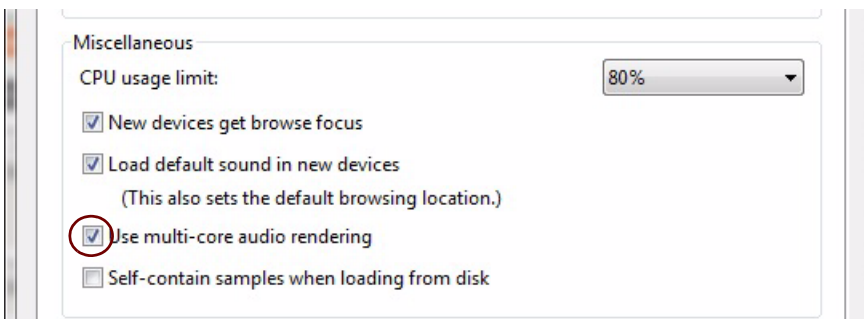

If you are working with a song document which has one single, very long and processor-heavy serial audio chain - and only a few devices that process the audio in parallel - you could try and deactivate the multi-core audio rendering option. This might enhance the performance in these special situations. However, under normal circumstances multi-core audio rendering is always the best option performance-wise.

## About hard drives

Most state-of-the-art hard drives, including SSD drives, will work perfectly together with Reason. Generally, the faster hard drive(s) you use, the better. Most mechanical hard drives of today runs at 5.400 rpm or faster, which is sufficient for use with Reason. A large hard drive is also highly recommended when working with DAWs like Reason. A single song with a lot of recordings in it could easily reach around 1 GB in final size. During recording and editing, the song file size could be a lot bigger than that, so a hard drive space of at least 20 GB is definitely recommended.

## General optimization tips

Finally, we'd like to share a couple of other general optimization tips:

- **Quit other programs that are running at the same time as Reason.**
- **Remove background tasks on your computer.**  
This might be any background utilities you have installed as well as networking, background internet activities etc.
- **Under Windows, make sure you use the latest and most efficient ASIO driver for your audio card.**
- **Only work on one Reason Song document at a time.**  
Songs that are open in the background do consume some processing power, even though they're not playing.
- **Lower the sample rate setting in the Preferences dialog.**  
While this also might reduce sound quality, it is a very quick and convenient way to try to play a song that your computer otherwise can't handle.

# Optimizing Songs

Below follows things you can check and change to make sure your song uses as little computer processing power and memory as possible:

## Global

- **To reduce the Song file size, delete unused recordings on Audio Tracks.**  
This won't affect the processing power but will reduce the Song file size, which might be desirable in many situations. See "[Delete Unused Recordings](#)".
- **Use the "Save and Optimize" function when you're finished editing your song.**  
As a final step, after you have recorded and edited your song, use the "Save and Optimize" function on the File menu. This will remove any "empty" disk areas in the song file, making the file as small as possible - see "[Saving and optimizing a Song](#)".
- **Bounce Mixer Channels.**  
If you're using a lot of devices in an instrument track, you could bounce the instrument track to an Audio Track. Doing so makes it possible to delete the instrument track afterwards and thus reduce the processing power. See "[Bouncing Mixer Channels](#)".
- **Delete unused devices.**  
If a device isn't actually doing anything, delete it from the rack.
- **Use fewer devices.**  
For example, instead of using several similar reverbs as separate insert effects, replace them all with one, set up as a send effect on a Send FX bus in the Main Mixer. By the same token, try to use one sampler playing several different samples instead of numerous samplers playing one sample each.
- **Don't use stereo unless it is required.**  
For example, if a sampler or Dr. Octo Rex loop player is playing mono material, only connect the Left output and leave the Right output unconnected.

## Main Mixer

- **Make sure you deactivate any channel strip parameters or sections you don't use in your song.**  
This could, for example, be Input Gain and INV, EQ, Filters, Dynamics and Insert FX.
- **Delete any Mix Channel devices and/or Audio Track devices you don't use in your song.**

## Sample Players – NN19, NNXT, Dr. Octo Rex and Redrum

- **Only activate High Quality Interpolation when it is required.**  
Listen to the sound in a context and determine whether you think this setting makes any difference.
- **If you are playing back a sample at a much higher pitch than it was recorded at, consider sample rate converting the actual sample file to a lower sample rate.**  
This will require an external sample editor with good sample rate conversion facilities.
- **Try to refrain from using stereo samples.**

## Filters – Subtractor, Thor, Malström, NN19, NNXT and Dr. Octo Rex

- **Deactivate filters that are not used.**  
Observe that if the Cutoff is all the way up or the envelope is set to open the filter fully, then the filter doesn't affect the sound. Conserve processing power by disabling the filter altogether.
- **Where applicable, use the 12dB lowpass filter instead of the 24dB lowpass filter.**  
See if you can get the same sonic result by using the 12dB filter, since it uses up less processing power.



## Polyphonic Devices – Subtractor, Thor, Malström, NN19, NNXT, Dr. Octo Rex and Redrum

- **Try making the device play fewer voices.**

This can be done for example by lowering the release and setting the Polyphony setting to exactly the maximum number of notes played simultaneously by this device.

! **Note that just lowering the polyphony setting has no effect. Unused voices do not consume processing power.**

- **Where applicable, try the Low Bandwidth (Low BW) setting.**

This will remove some high frequency content from the sound of this particular device, but often this is not noticeable (this is especially true for bass sounds).

### Subtractor

- **Try avoiding using Oscillator 2 altogether.**

If you can create the sound you need with only one oscillator, this saves considerable amounts of processing power.

- **Do not use the oscillator Phase mode if you don't need it.**

In other words, set the Oscillator Mode switches to “o”, not “.” or “-”.

- **Do not activate Noise unless required.**

- **Do not activate Filter 2 unless required.**

- **Do not use FM unless required.**

In other words, set the oscillator FM knob to “0” and make sure no modulation source is routed to FM.

### Thor

- **In general, unload any filters or oscillators that aren't used.**

### Malström

- **If it isn't necessary, refrain from using Osc B at all.**

If you can produce the desired sound by using Osc A only, this will save a lot of processing power.

- **If one or both Oscillators are routed to one Filter only, and/or the Spread parameter is set to “0”, only connect one of the outputs (the one to which the filter is connected) to the mixer, and leave the other one unconnected.**

- **Try to see if you can achieve the desired effect by using only one of the filters, and without using the shaper.**

Using both of the filters and the shaper in conjunction requires considerably more processing power than using just one of the filters and/or the shaper.

### Redrum

- **Do not use the Tone feature available on channels 1, 2 and 9.**

Make sure the Tone controls and their accompanying Vel knobs are set to “0” (“twelve o' clock” position).

### Mixer devices

- **Avoid using stereo inputs when not required.**

For example, if your sampler or Dr. Octo Rex player is playing mono material, only connect it to the Left input on a mixer channel. Leave the Right input unconnected.

- **Do not activate EQ (Mixer 14:2 only) unless required.**

If a channel doesn't make use of EQ, make sure it's EQ button is deactivated.

## Distortion

- **The D-11 Foldback Distortion will use up less CPU power than the Scream 4 Distortion device.**

## Reverb

- **The RV-7 uses much less power than the RV7000.**  
For some applications the RV-7 might do just fine, and will use up much less power.
- **If you are running out of processing power, try the Low Density algorithm for the RV-7.**  
This uses up much less power than other algorithms.

## Send Effects

- **When you are using mono effects as send effects, you can connect the effect returns in mono as well (disconnect the cable to Aux Return Right on the Main Mixer).**  
This is true for the following effects:
- **D-11 Distortion**
- **Scream 4 Distortion**
- **ECF-42 Envelope Controlled Filter**
- **COMP-01 Compressor**
- **PEQ-2 Parametric EQ**
- **DDL-1 Delay (provided the Pan parameter is set to center position).**
- **MClass effects; Equalizer, Compressor, Maximizer.**

# RAM requirements

Songs not only use up system resources in terms of processing power and hard disk space, they also require RAM (memory) to load at all. The amount of RAM required for loading a song, is directly proportional to the amount of samples used in the song. For example, a song which uses only Subtractors and effects requires very little RAM.

If you are running out of RAM try the following:

- **Close other Song documents.**  
All open songs compete for RAM.
- **Terminate other applications.**  
All running applications compete for the RAM available in the computer.
- **Use mono samples instead of stereo ones.**  
Mono samples require half the amount of RAM.
- **Try sample rate converting sample files to a lower sample rate.**  
Note that this could affect sound quality negatively. Also note that it will require an external sample editor with good sample rate conversion facilities.

# **Chapter 24**

## **Hardware Interface**

# Introduction



The Hardware Interface device is where you connect Reason to the “outside world”. This is where MIDI is received, and where audio signals are routed from physical inputs and to physical outputs of your audio hardware. Here is also where audio output signals are routed to ReWire channels. The Hardware Interface is always present at the top of the rack, and cannot be deleted. This chapter is meant to serve as a panel reference, describing the various sections of the device. How to set up your audio hardware is described in the “[Audio Basics](#)” chapter.

The Hardware Interface is normally unfolded, showing a panel with 2 Sampling Inputs, 16 Audio Inputs and 16 Audio Outputs and a couple of buttons.

- **On the right hand side at the top of the panel are the Input Focus and Play Focus buttons - these are described in “[Input Focus and Play Focus](#)”.**
- **The Sampling Input, Audio Input and Audio Output sections feature a LED meter for each input and output channel.**
- ! **Remember that the Hardware Interface is where any possible audio clipping will occur in Reason. Keep an eye on the clipping indicator on the Transport Panel, and also on the individual meters on the Hardware Interface panel. If a channel pushes the meter into the red, the level should be reduced at the source - see “[About audio levels](#)” in the “[Audio Basics](#)” chapter.**
- **The multi-color LEDs below each channel indicate the following:**
  - Green LED: Available and used channel (cable connected to the channel jack on the rear panel).
  - Yellow LED: Available but unused channel (no cable connected to the channel jack on the rear panel).
  - Red LED: Unavailable channel but with a connected cable on the rear panel. No audio will be present on channels with red LEDs.
  - Unlit LED: Unavailable and unconnected channel (no cable connected to the channel jack on the rear panel).
- **By clicking the “ADVANCED MIDI” button at the top on the panel, the Advanced MIDI Device panel is shown:**



Refer to “[Advanced MIDI Device](#)” for more information.

- **By clicking the “MORE AUDIO” button at the top on the panel, an additional Audio In and Out panel is shown for a total of 64 inputs and outputs.**



Refer to “[More Audio](#)” for more information.

- By clicking the “BIG METER” button at the top on the panel, a panel with bigger audio level meters is shown:

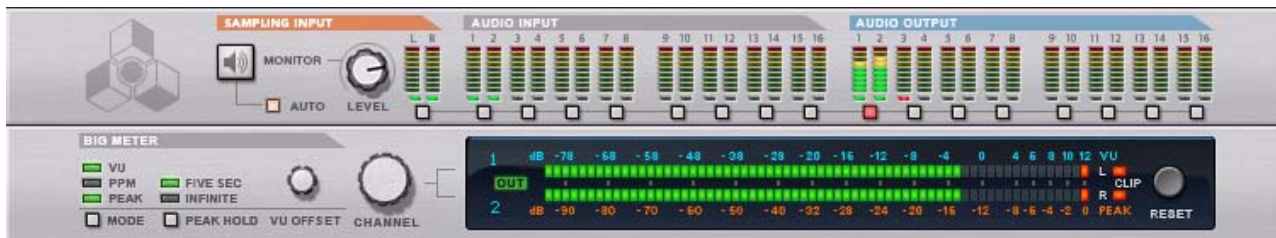

Refer to “The Big Meter” for more information.

## About using ReWire

If you are running Reason together with a ReWire compatible host application, you can route any Reason device output to a ReWire channel by connecting the device to any of the audio out connectors at the back of the Hardware Interface. In ReWire mode, all 64 channels are available and any device output routed to a ReWire channel will appear in the ReWire host application on it's own channel. See the “ReWire” chapter for more information.

## Sampling Input section



The Sampling section features two audio inputs (L & R) to which you should route the audio signals you want to sample. There is also a Level knob and two Monitor buttons. See “Setting up for sampling” for details on how to sample.

# Advanced MIDI Device



This is opened by clicking the “ADVANCED MIDI” button on the Hardware Interface panel. The Advanced MIDI device is only used if you are controlling Reason from an external sequencer, using the External Control Bus inputs. Normally, you send MIDI to a track via the sequencer, by selecting the sequencer track.

You can select MIDI ports for up to four External Control Busses (on the Sync page in Preferences). Each bus can host 16 MIDI channels, for a total of up to 64 MIDI input channels. The Advanced MIDI Device is where you can route each MIDI channel to a specific device in the Reason rack:

- 1. Select one of the External Control Busses by clicking the corresponding Bus Select button at the top of the Advanced MIDI device.**
- 2. Pull down the device pop-up menu for a MIDI channel and select a device.**  
The menu lists all devices in the current song.

Now, incoming MIDI data on the selected bus and MIDI channel is sent directly to the selected device, bypassing the Reason sequencer. The name of the device is shown in the name field for that MIDI particular channel.

- 3. Try sending MIDI notes from the external sequencer, on the selected bus and MIDI channel.**  
The indicator below the channel's name field should light up.

See also “[Advanced MIDI - The External Control Bus inputs](#)” in the Advanced MIDI and Synchronization chapter.

## More Audio

Reason supports up to 64 audio input and 64 audio output channels. The additional 48 inputs and 48 outputs can be found on the “More Audio” panel.

→ To view inputs 17-64 and outputs 17-64, click the “More Audio” button.



Each additional input and output features a meter and a multi-color LED indicator which will be lit in different colors depending on current state - see “[Introduction](#)”.

# The Big Meter

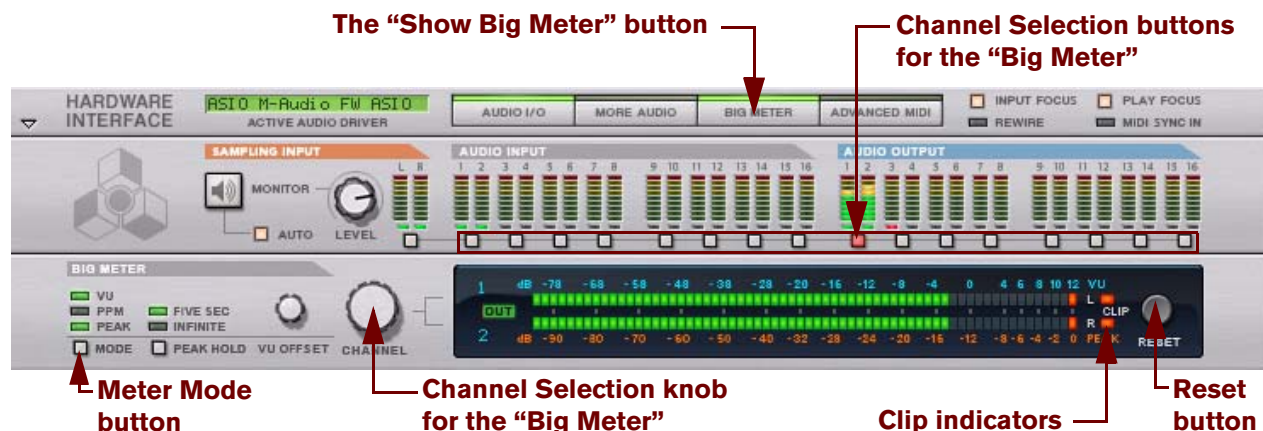

To get a better overview of the levels of a particular channel pair you can bring up the Big Meter on the Hardware Interface.

**1. Click the “Big METER” button on the front panel.**

The “Big Meter” panel shows up.

**2. Select the Input or Output pairs to view in the Big Meter by clicking on the corresponding Channel Selection button below each Input or Output pairs.**

Alternatively, select channel by turning the Channel Selection knob.

**→ It’s also possible to select various Meter Modes, or combinations of Meter Modes, by clicking the Meter Mode button to the far left.**

The available Meter Modes are:

• **VU**

The VU Mode simulates the behavior of analog meters and shows the RMS (Root Mean Square) value of the signal. Since the RMS value is an "average" of the signal level over time it's not suited for detecting fast transients in the sound. Rather, VU meters are useful for monitoring the overall loudness of the signal.

In VU Mode, the meter response is 300 ms/20 dB for both attack and release. There is no peak segment in the meter.

**→ The VU Offset can be set in 2 dB steps between -20 and 0 dB, by turning the VU Offset knob.**

This setting determines how the VU dB scale relates to the Peak dB scale. If you have no specific preference in this matter, you don't need to change the VU Offset.

**! The VU Offset setting will affect the readout of all Meters on the Main Mixer channel strips and on their corresponding Rack devices.**

• **PPM**

In PPM (Peak Program Meter) Mode, the meter response is 0 ms rise and 2.8 s/24 dB fall. The PPM Mode is perfect for detecting transients in the sound. There is no peak segment in the meter.

• **PEAK**

In PEAK Mode, the meter response is 0 ms for both rise and fall, which means that this mode provides the most accurate representation of the signal level over time. Since the fall time is 0 ms, it could be quite distracting to the eyes to watch the meters in PEAK mode. If so, the PPM Mode might be more convenient since it's equally fast at responding to transients, but falls more slowly.

The peak segment (the rightmost LED segment, indicating the highest level) has a fall time according to the Peak Hold parameter setting (5 seconds or infinite). This allows you to more easily spot very brief level peaks.

- **VU+PEAK**

In VU+PEAK Mode, the meter response is according to the VU Mode, plus a peak segment.

- **PPM+PEAK**

In PPM+PEAK Mode, the meter response is according to the PPM Mode, plus a peak segment.

If the audio level for the selected is, or have been, too high, the Clip indicators on the Big Meter will stay lit until you click the "Reset" button, or select new audio channels for the Big Meter. See ["About audio levels"](#) for more information on how to use and work with the Big Meter.



# **Chapter 25**

## **The Combinator**

# Introduction



The Combinator is a special device that allows you to save and recall any combination of Reason and/or Rack Extension devices (instruments, effects, mixers etc.) and their internal connections. A saved Combinator setup can be loaded as a patch, called a “Combi”. The Combinator device itself acts as a container for the devices in a Combi.

The basic idea behind the Combinator device is simple, but very powerful. Being able to save multiple devices as a Combi enables you to instantly recall any type of setup, however complex, as simply as loading a patch!

Some typical applications of the Combinator:

- **Create split or layered multi-instruments.**  
Add any number of instrument devices and play them as a single layered instrument. Instrument devices in a Combi can also be assigned to specific keyboard/velocity zones.
- **Save instrument/effect combinations.**  
Save an instrument together with your favorite effect(s).
- **Create multi-effect devices.**  
You can create and save complex effect chains as Combis.

## About the Combi patch format

The Combinator saves files in the Combi (.cmb) patch format. When you load a ready-made Combi patch, all devices included in the Combi, their corresponding parameter settings and audio and CV connections are instantly recalled.

The Factory Soundbank includes many preset Combinator patches, divided into various categories.

There are two basic types of Combi patches; instrument and effect combis.

- **Instrument Combis contain instrument devices and generate sound.**
- **Effect Combis contain effect devices and are used to process sound.**  
These Effect Combis can e.g. be loaded as insert effects in the Main Mixer channel strips and Master Section. They can also be created as send effects in the Main Mixer Master Section using the “Create Effects...” command on the Create menu.

# Creating Combinator devices

## Creating an empty Combinator device

- **Add a Combinator device from the Utilities palette in the Browser.**  
Either double click the device or drag and drop from the device palette to the rack.
- **Select “Combinator” from the Create menu.**  
This will create an empty Combinator. Empty Combinator devices can be used as a starting point when creating new Combi patches. It also allows you to browse for existing Combi patches.

## Creating a Combinator by combining devices

You can create a Combinator device by combining existing devices:

- 1. Select two or more devices in the rack by [Ctrl]-clicking (Win) or [Shift]-clicking (Mac).**  
The devices do not have to be adjacent in the rack.
- ! Note that you should never select any Mix Channel or Audio Track devices, since this will disable the “Combine” function described below.**
- 2. Select “Combine” from the Edit menu or context menu.**

This creates a Combinator device containing the devices that were selected according to the following rules:

- **A sequencer track is created for the Combinator, just as when creating instrument or pattern devices.**
- **The new Combinator device appears at the position below the selected device that is farthest down in the rack.**
- **The selected devices are moved to be contained within the Combinator’s “holder”.**  
Their internal order is not changed. Reason attempts to autoroute the first “input device” and first “output device” to the Combi To/From Devices connectors - see [“About internal and external connections”](#). Other connections are unchanged.
- **Devices outside the Combi remain in the same order as before.**
- ! Please see [“Adding devices to a Combi”](#) for details about auto-routing.**

## Creating a Combinator by browsing patches

You can use “Create Instrument” or “Create Effect” to create a Combinator device (just as you can any device). If you select a .cmb patch a Combinator will be created containing all devices and settings saved in the Combi.

# Combinator elements

In the picture below an unfolded Combinator device is shown.



The front of the Combinator consists of the following elements (from the top down):

- **The narrow panel at the top is always shown, even when the whole Combinator is folded.**  
It contains a display which (amongst other things) shows the name of the currently loaded Combi, and standard Select/Browse/Save patch buttons.
- **Next is the Controller panel, which is always shown if the Combinator is unfolded.**  
See [“The Controller panel”](#).
- **The Programmer panel contains settings for Key and Velocity Zone mapping as well as Modulation Routing settings.**  
The Programmer can be shown/hidden by clicking the “Show Programmer” button on the Controller panel. See [“Using the Programmer”](#).
- **At the bottom are the devices included in the Combi.**  
Devices can be shown or hidden by clicking the “Show Devices” button on the Controller panel. The empty space at the bottom is used for adding more devices to a Combi by drag and drop. Clicking the empty space so that the red Insertion line appears also makes the Combi the target container for new created devices (from the Create menu). See [“About the Insertion line”](#).

# About internal and external connections

Unlike other devices, the Combinator contains both external and internal audio connections.

- **External connections are used to connect a Combinator to devices outside the Combi.**
- **Internal connections are how devices within the Combi are connected.**

## External connections



- **The “Combi Output L/R” connectors carry the audio output of the Combinator.**  
This output connects with a device outside the Combi, normally a mixer. Internally, this output is connected to the “From Devices” connectors. When you create a new Combinator this output will be auto-routed to the first available mixer input channel.
- **The “Combi Input L/R” connectors is the input to the Combinator (used for effect Combi only).**  
Internally, this input is connected to the “To Devices” connectors.

## Internal Connections



- **The “From Devices L/R” inputs is where the outputs from devices in the Combi are connected.**
- **The “To Devices L/R” outputs connect to an input on a device in the effect Combi.**

## About External Routing

If an individual device in the Combi is directly connected to a device outside the Combinator, this is known as an “External Routing” connection, which should generally be avoided. The reason for this is that such connections are not saved with the Combi patch.

- **Therefore, all connections to/from a Combi should pass via the To/From Device connectors on the Combinator device if you wish to make the Combi self-contained.**

If a Combi contains external routing connections, this is indicated both on the front and back panels of the Combinator; On the front panel “External Routing” is displayed in the Patch name display, and on the back panel a LED indicator is lit.

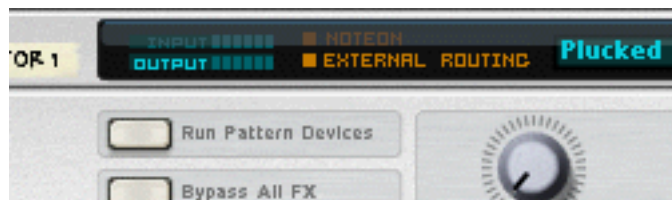

It is still possible to use a Combi with External Routing connections within the context of a song (where all routings are saved with the song). Just keep in mind that the external routing connections will not be part of the patch!

## How to avoid external routing connections

As explained previously, all connections to/from a Combinator device should pass via the To/From Device connectors in order to make the Combi self-contained. Therefore you need to include a mixer device for Combis with more than 2 device outputs.

Say you were to combine three instrument devices (each with stereo outputs connected to a mixer) in order to create a layered or split instrument Combi.

If you simply selected these three instrument devices (but not the mixer) and then selected “Combine”, only one of the devices would be auto-routed to the “From Devices” connectors, while the other two devices would have the same connections they had before combining.

Therefore:

- **When combining several instrument devices, connect them to a mixer device and include this mixer in the Combi.**

This way, all the instrument device outputs in the Combi can be connected to separate input channels in the mixer. The mixer device output can then be routed via the “From Devices” connectors and thus the Combi will be self-contained.



*Instrument devices and effects connected to a Line Mixer 6:2 within the Combi.*

- **The Line Mixer 6:2 is ideally suited for mixing device outputs in Combis (see “[The Line Mixer 6:2](#)”).**

# Adding devices to a Combi

## About the Insertion line



When the Insertion line is shown, new created devices will be added to the Combinator device.

- **To be able to select the Insertion line you have make sure that the “Show Devices” button is lit on the Combinator Controller panel.**
- **The Insertion line is shown in the empty space at the bottom of the Combinator holder (below any devices currently in the Combi).**  
If the Combi doesn't contain any devices, the empty space is located just below the Controller panel.

## Showing the Insertion line

Any of the following methods will select/show the Insertion line:

- **By clicking in the empty space at the bottom of the Combinator holder.**
- **When creating a new Combi, the Insertion line is automatically selected.**
- **By using the arrow keys you can step through and select each device currently in the Combi. By selecting the empty space, the Insertion line appears.**
- **Selecting “Initialize Patch” for a Combinator will clear all devices and the Insertion line appears.**
- **Note that showing the Insertion line automatically selects the Combinator device. However, selecting the Combinator will not automatically show the Insertion line.**  
The Insertion line remains selected until you select another device (either in the Combi or in the rack), or hide the devices.

## Creating new devices in a Combi

To make a Combinator the target device for created devices you have to use one of the following methods:

- **Showing the Insertion line (see “[Showing the Insertion line](#)”).**  
If you create a device with the Insertion line showing, the new device will appear below the Insertion line, at the bottom of the Combi holder.
- **Selecting a device in the Combi (but not the Combi itself).**  
When you select a device from the Create menu it will appear below the selected device (just like in the rack).
- **No sequencer tracks will be automatically created for devices added to a Combi.**

## About auto-routing

The auto-routing of devices in a Combi is similar to devices in the rack:

- **If a device in a Combi is selected, the new created device will appear below the selected device according to standard rules.**
  - **If an effect is selected and you create a new effect device, these will be connected serially.**
  - **If an instrument device is selected and you create an effect it will be connected as an insert effect to the instrument device.**
  - **If a mixer is selected and you create an effect it will be connected as a mixer send effect.**
  - **If an instrument device is selected and you create another instrument device it will be added below the selected device and connected to the first available mixer input channel.**
  - **If you hold down [Shift] and create a new device, no auto-routing will take place.**
  - **If you hold down [Option] (Mac) or [Alt] (Windows) and create a new device, a sequencer track will be created for the device.**
- **If you add a device to an empty Combi, its output will be auto-routed to the “From Devices” connectors. For effect devices, the input will also auto-route to the “To Devices” connectors.**

## Adding devices using drag and drop

You can move devices in the rack that are currently outside the Combi into the Combinator holder. This works as follows:

- 1. If you want to add more than one device at the same time, [Ctrl]-select (Win) or [Shift]-select (Mac) the devices.**

- 2. Click on the panel area of a device.**

You can click anywhere outside the actual parameters and displays.

- 3. Drag the device(s) into the Combinator.**

A thick red vertical line indicates where the device(s) will be positioned. Note that the red line can be to the left of a device (indicating that the moved device will be inserted before the other device) or to the right of a device (indicating that the moved device will be inserted after the other device). You can also add devices to the empty space at the bottom of the Combi holder.

- **No auto-routing will take place.**

The existing connections to the rack will be kept, so there may be external routing connections (see [“About External Routing”](#)). If there are, “External Routing” will be shown the Combinator name display (and on the back of the Combinator a LED indicator will be lit).

- **If you drag devices into the Combi with [Shift] pressed, the devices will be disconnected from the rack and auto-routed according to the insert position.**

The routing between dragged devices will be kept. If it isn't possible to auto-route a dragged device (e.g. if there's no free mixer inputs in the Combi), the device will become unconnected.

- **If you drag devices into the Combi with [Alt](Win) or [Option](Mac) pressed, the devices will be copied. No auto-routing takes place.**

Using [Shift] at the same time will attempt to auto-route according to the same rules as described above.



## Adding devices using copy/paste

You can copy devices and paste them into a Combi.

1. **Select the devices you wish to copy as usual.**
  2. **Select “Copy Device” from the Edit (or context) menu.**
  3. **Select a device in the Combi or click the empty space to show the insertion line.**
  4. **Select “Paste Device” from the Edit (or context) menu.**
- **When pasting, the devices will be added below the currently selected device or the Insertion line in the Combi.**  
No auto-routing takes place.
  - **Pressing [Shift] when pasting will attempt to auto-route according to standard rules.**

## Adding a Combi to a Combi

Nested Combis (i.e. a Combi within a Combi) is not supported. If you open the Create menu when the Insertion line or a device in a Combi is selected, the Combinator item will be grayed out.

You can, however, use drag and drop or copy/paste to add a Combi to another Combi. The following then applies:

- **The devices in the dragged (or pasted) Combi will be “uncombined” (i.e. the Combinator device itself will be removed) and the devices will be added below the insert position in the target Combi.**  
Existing routing will be unchanged.
- **If you press [Shift] when dragging (or pasting) the uncombined devices will be auto-routed as if it was a single device.**  
The “From Devices” Output (and “To Devices” input if applicable) used in the uncombined Combi will be auto-routed to the target Combi, according to standard rules.

## Combining two Combis

- **The lower Combi will be uncombined and the devices added to the upper Combi in the rack when combining.**  
Existing routing will be unchanged.

## Combining devices in a Combi with devices in the rack

If you combine some devices in a Combi with devices in the rack, the combined devices are removed from their original locations and added to a new Combi (below the “original Combi”).

## Combi handling

### Moving the entire Combi

This works much the same as for other devices in the rack.

- **Select the Combinator by clicking on the holder and drag to a new position.**  
An outline of the Combinator is shown when you drag, and a red line shows the insert position. All connections are kept.
- **If you press [Shift] when dragging the Combinator will attempt to auto-route to the insert position in the rack according to standard rules.**  
The auto-routing will take into account whether it is an effect Combi or an instrument Combi.

- **If you press [Alt](Win) or [Option](Mac) while dragging, a copy of the Combi is created.**

No Auto-routing takes place. If you press [Alt](Win) or [Option](Mac) + [Shift] the copied Combi will be auto-routed according to standard rules.

## Moving devices within a Combi

Just as for devices in the rack, an outline of the devices is shown when you drag, and a red line shows the insert position. All connections are kept.

- **If you press [Shift] when dragging, the device(s) will attempt to auto-route to the insert position according to standard rules.**

## Moving devices out of a Combi

If you move devices out of a Combi the following applies:

- **The routing is unchanged, and the External Routing indicator is likely to light up.**

If you press [Shift] when dragging, the device(s) will attempt to auto-route to the rack according to standard rules.

## Deleting devices in a Combi

This works exactly as for devices in the rack. Select the device and then either select “Delete Devices and Tracks” from the Edit menu or context menu, or press [Backspace].

## Uncombining devices

You can uncombine a whole Combi or selected devices within a Combi in the following way:

- **If you select a Combinator and then select “Uncombine” from the Edit menu, the Combinator device will be removed, and all devices contained in the Combi will be connected as a single device to the rack.**

The devices previously connected to the To/From Devices connectors will now be connected to the rack in the same way the Combinator device was (via the Combinator output and input).

- **If you uncombine a few selected devices in a Combi these will be removed from the Combi and added to the rack below the Combi.**

Connections are unchanged, so external routing is likely to happen.

## Sequencer tracks and playing Combis

When you create a Combinator device, a sequencer track is automatically created. This track is also given Master Keyboard Input just like standard instrument devices.

- **When the Combinator track receives incoming MIDI data, this will be routed to all instrument devices in an instrument Combi.**

This means that the devices will be layered when you play (taking default velocity and key ranges into account).

- **You can turn off Receive Note or selected Performance controller data for individual instrument devices in the Programmer panel.**

See “[Using the Programmer](#)” for details.

# The Controller panel



This is the main Combinator panel. Like standard instrument devices it features Pitch and Mod wheels and various controls.

## About the virtual controls

- **The four Rotary knobs and buttons in the middle of the Controller panel are “virtual” controls that can be assigned to parameters and functions in devices contained in the Combi.**  
These controls are by default not assigned to any parameters in new Combis.
- **You assign parameters in the Modulation Routing section of the Programmer panel (see “Using Modulation Routing”).**
- **Movements of the virtual controls can be recorded as automation.**
- **Each control can be assigned to any number of parameters.**
- **Clicking on the label for a Rotary or Button lets you type in an appropriate name for it.**

## The Pitch Bend and Modulation wheels

The Pitch and Mod wheels on the Controller panel will mirror the corresponding actions on your master keyboard, just like for standard instrument devices.

- **When a Combinator device has Master Keyboard input and the Combi contains several instrument devices these will all receive pitch bend and modulation data.**  
The settings in the instrument devices determines what happens when applying pitch bend or modulation.
- **For example, moving the Mod wheel could apply vibrato for one device and change the filter cutoff frequency for another device.**
- **Pitch Bend will also be applied according to individual settings in the Range field for all instrument devices in a Combi.**

## Run Pattern Devices button

This can be used to start/stop all (Reason) pattern devices included in the Combi. This works exactly as pressing the Run button on the pattern device panel. The on/off status of this button is not saved with the Combi patch. Pressing play on the transport panel will automatically activate “Run Pattern Devices”.

- **In the Reason Factory Sound Bank, Combi patches containing pattern devices have “(run)” at the end of their patch names.**

## Bypass All FX

This button allows you bypass all effect devices in a Combi. It works as follows:

- **All insert effect devices in the Combi are switched to Bypass mode.**
- **All effects connected as send effects to a mixer device are switched off.**
- **Clicking this button will not affect effect devices that were bypassed or turned off already.**

## Select backdrop...



This function allows you to change the “skin” of the Controller panel. You can design your own labels for the assignable controls, and change the color and look of the whole panel.

→ **Select the Combinator and choose “Select Backdrop...” from the Edit menu.**

The Image browser opens, allowing you to select image file in the JPEG (.jpg) format.

→ **The dimensions of the image file should be 754 x 138 pixels.**

→ **The knobs, buttons, patch name display and patch buttons cannot be redesigned.**

→ **If you wish to design your own text labels for the virtual controls, you should first remove the original text labels.**

Click on a label, remove the current text and press [Enter].

→ **To remove a Backdrop, select “Remove Backdrop” from the context menu.**

The original look of the Combinator panel is restored.

### About template backdrops

As with the Kong device, it is possible to customize the Combinator front panel graphics with a user-designed skin. In the [Reason Download](#) section at the Propellerhead website is the “Combi and Kong Backdrop Templates” zip file, which contains PhotoShop (.psd) files which can be used as starting point for designing your own Combinator panel graphics. See the “Read Me.txt” file in the Backdrops folder for more details.

Two templates are available, one in the JPEG format and the other in the Adobe Photoshop format (.psd).

→ **The .psd (Photoshop) template contains multiple layers, which are useful when customizing backdrops.**

You have to save any backdrops created in Photoshop as JPEG files before you can use them in Reason.

# Using the Programmer

The Programmer is used for key mapping and setting velocity ranges for instrument devices, and for Modulation Routing; assigning device parameters to the knobs and buttons on the Controller panel.

- **To show the Programmer panel, click the “Show Programmer” button on the Controller panel.**

The Programmer appears below the Controller panel.



- **To the left on the Programmer panel the devices in the current Combi are listed in the same order they appear in the Combinator holder.**

Clicking on a device in the list selects it for editing.

- **The middle Key Mapping section features a keyboard with a horizontal scroll bar at the top. In the area below it the key range for each instrument device is shown.**

- **To the right is the Modulation Routing section where you can assign parameters to the controls on the Controller panel.**

See “[Using Modulation Routing](#)”.

# Key Mapping instrument devices

Each instrument device can have its own separate key range, the lowest and the highest key that will trigger the device. This allows you to create splits and layers for instrument devices in a Combi.

1. **Make sure the Combinator track has Master Keyboard Input.**
2. **Select an instrument device in the Device list to the left (non-instrument devices, e.g. effects and mixers do not have key ranges).**

The currently selected device key range is highlighted and shown as a horizontal bar under the keyboard display, and as note numbers in the Key Range Hi and Lo fields at the bottom of the Programmer panel. By default, the entire range is selected (C -2 to G 8). Only one device at a time can be selected.

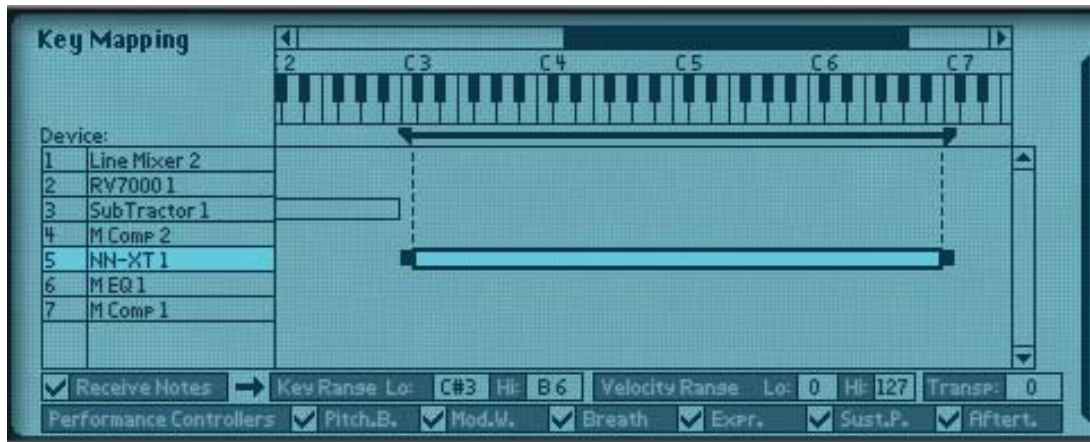

There are several ways you can change the current key range:

- **By clicking in the Key Range Lo and Hi value fields and moving the mouse up or down.**
  - **By moving the handles of the horizontal bar in the middle display.**  
You may have to use the scrollbar at the top to “see” the handles.
  - **By dragging the horizontal bar itself you can also move entire key zones horizontally, thereby changing their key ranges.**
3. **Using either method, set the desired key range for the selected device.**  
When done, the device will only play back notes in the set key range.
- **By setting up key ranges for devices in a Combi, you can create split instruments.**  
For example playing notes below C 2 could trigger a device playing a bass sound, whereas playing notes above C 2 could trigger a device playing a pad sound.
  - **Instrument devices in a Combi that share the same key range will be layered - i.e. play at the same time.**  
This given that no velocity ranges have been set up - see below.
  - **You can of course set up overlapping ranges where notes within a set key range will layer two (or more) devices, but notes above and below the set range will play separate devices.**

## About the Transpose function

The Transpose field in the right bottom corner allows you to transpose the currently selected instrument device. It will not shift the key mapping, just the pitch of the selected device. Range is +/- 3 octaves, in semitone steps.

## About the keyboard

You can use the keyboard to audition selected instrument devices by pressing [Option] (Mac) or [Alt] (Windows) and clicking on the keys.

## About the Receive Notes/MIDI Performance Controller checkboxes

In the lower left corner of the Programmer there is a Receive Notes field with a corresponding checkbox, and below there are checkboxes for all standard MIDI Performance controllers (Pitch Bend/Mod Wheel/Breath/Expression/Sustain Pedal/Aftertouch).

→ **These checkboxes allow you to control whether Note/MIDI Performance controller data is to be received for each instrument device in a Combi.**



→ **If you deactivate the “Receive Notes” checkbox the selected device will not respond to incoming MIDI note messages.**

If a non-instrument device is selected this checkbox is always deactivated.

→ **If you deactivate any of the Performance Controllers, the corresponding controller(s) will not be received by the selected instrument device.**

All are on by default.

## Setting Velocity Ranges for instrument devices

When instrument devices are set up so that their key ranges overlap – completely or partially – you can use velocity switching to determine which devices should be played back depending on how hard or soft you play on your MIDI keyboard.

This is done by setting up velocity ranges.

Each time you press a key on your MIDI keyboard, a velocity value between 1-127 is sent to Reason. If you press the key softly, a low velocity value is sent and if you press it hard, a high velocity value is sent.

This velocity value determines which devices will be played and which will not.

**1. Select an instrument device in the Device list to the left (non-instrument devices, e.g. effects and mixers do not have velocity ranges).**

By default, the entire range is selected (0 - 127).

**2. Click in the Velocity Range Lo and Hi value fields and move the mouse up or down to set a low and high velocity range, respectively.**

**3. When you have set a range, the device will only be triggered by notes within this velocity range.**

## About overlapping Velocity Ranges

You can set overlapping velocity ranges. Here's an example of how this can work:

- **Device 1 has a velocity range from 1-60.**
- **Device 2 has a velocity range of 41-100.**
- **Device 3 has a velocity range of 81-127.**

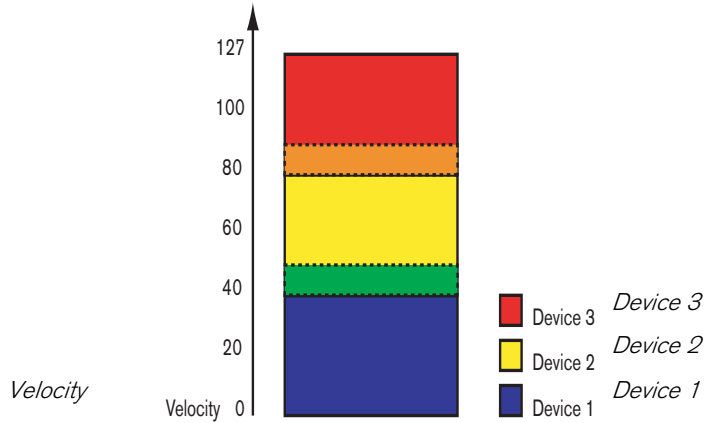

Now, velocity values between 41 and 60 will trigger notes from *both* Device 1 and Device 2. Likewise, velocity values between 81 and 100 will trigger sounds from Device 2 and Device 3.

## About full and partial velocity ranges

You can see which devices have modified velocity ranges in the key map display:

- **Devices with a full velocity range (0 - 127) are only shown with an outline.**
- **Devices with any other velocity range are shown as striped.**

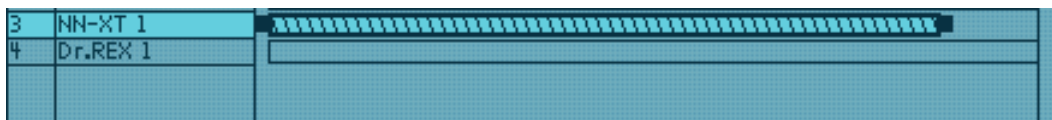

*The device has a partial velocity range, which is indicated by stripes.*

## Using Modulation Routing

The Modulation Routing section allows you to assign any parameter or function in devices included in a Combi to any of the virtual Rotary and Button controls on the Controller panel. You can also control Combi Programmer parameters by connecting external CV modulation sources to any of the four Programmer CV Inputs on the back of the unfolded Programmer panel.

## About Rotary and Button controls

The virtual Rotary and controls operate much like the equivalent controls on the real devices:

- **A Rotary control can either smoothly change parameter values (e.g. a level control), or step through fixed values (like the Oscillator waveform spin controls on a Subtractor).**



→ **A Button control will switch between two set values like an on/off switch.**

Worth noting is that there are buttons on several Reason devices that will step through a series of values, for example LFO Waveform buttons. If LFO Waveform is assigned to one of the virtual Buttons you will only be able to switch between two of the six LFO waveforms (which waveforms is determined by the Min/Max range).

→ **The available range for each selected parameter is shown in the Modulation Routing Min/Max fields.**

Most sliders and rotary knobs on the actual devices have the standard 0-127 or -64 to 63 range. Selectors and spin controls can have any value range.

## About the Programmer CV Inputs

On the back of the Programmer panel are four CV Modulation Inputs for connecting external sources to modulate any of the parameters that are accessible in the Target section in the Programmer, see ["Programmer CV Inputs"](#).

## Assigning parameters to a control

This is done as follows:

**1. Select the device you wish to assign parameters for in the device list to the left.**

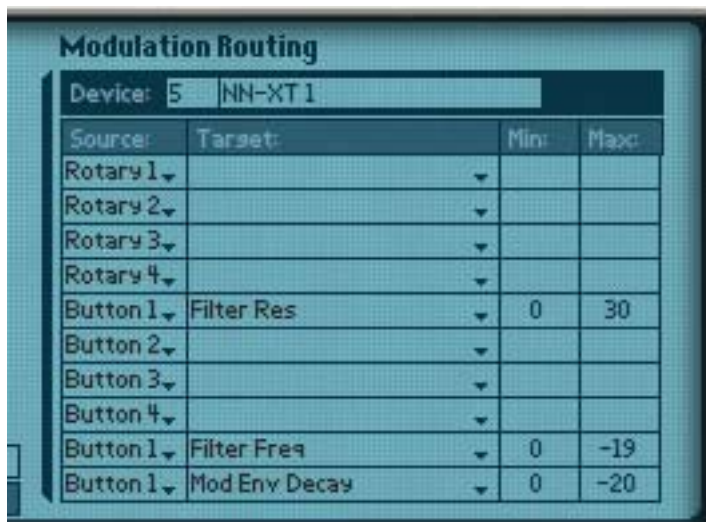

The name of the selected device is now shown in the Modulation Routing Device field. The Modulation Routing section contains four columns:

- **In the Source column, the four Rotary and Button controls are by default listed but each field can be changed to any Rotary/Button/CV Input or Performance controller by clicking the arrow and selecting from the pop-up.**  
The last two fields are unassigned by default.
- **The pop-ups in the Target column contain all parameters for the selected device.**
- **Lastly in each Target pop-up list is the option to receive note data or not.**
- **The Min/Max columns allow you to specify a value range for the virtual control.**

**2. Click in the Target column for the Rotary or Button control you wish to assign a parameter.**

On the pop-up that appears, all the available parameters for the device are listed.



**3. Select the parameter you wish to assign to the control.**

The parameter is now assigned, and the name of the parameter is shown in the Target column for the corresponding control.

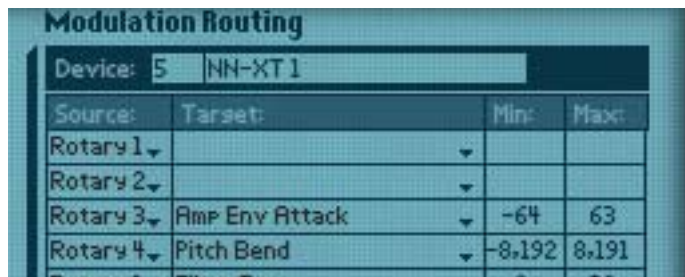

**4. If you wish the selected device to receive notes this option should be checked.**

**5. If you move or press the assigned Rotary or Button it will now control the parameter you assigned to it.**

**6. You can specify a range for the parameter by clicking in the Min and Max columns and moving the mouse up or down.**

By default the maximum available range is set.

**7. If you select another device in the Device list to the left, you can assign another parameter to the same Rotary or Button control using the same basic method.**

This means that you can create multi-function controls that operate simultaneously on several parameters. E.g. if you have two Subtractors and a Malström in a Combi you could create a “master” filter cutoff knob, that controls this parameter for all three devices.

## Naming a control

When you make modulation routing assignments, you should give the associated control a descriptive name that reflects what it does, for example Vibrato On/Off or the name of the parameter that it controls.

This is done by clicking the label on the Controller panel and typing in new name.

## CV Connections

CV connections between devices in the Combi are saved with the Combi patches. This is also true for CV connections between devices in Combi and the Combi itself - e.g. if you have connected a Matrix in the Combi to one of the CV inputs on the back of the Combi panel.

The following CV connectors can be found at the back of the Combinator:

## Sequencer Control Inputs

The Sequencer Control CV and Gate inputs allow you to play the Combinator from another CV/Gate device (typically a Matrix or a RPG-8). The signal to the CV input controls the note pitch, while the signal to the Gate input delivers note on/off along with velocity.

## Modulation Inputs

In this section you will find standard CV Mod Wheel and Pitch Bend modulation inputs, as well as modulation inputs for the four Rotary controls.

**! Parameter(s) that are assigned to a Rotary control can thus be modulated by CV, which allows you to use CV control for almost any Reason parameter!**

## Programmer CV Inputs



Here you can connect external CV modulation sources for modulating any of the Target parameters in the Programmer (see [“Using Modulation Routing”](#)). Next to each CV Input are one sensitivity knob and one polarity switch that work as follows:

- **The sensitivity knobs can be used for attenuating the CV Input signal.**
- **The polarity switches should be used for defining the polarity of the CV Input signal.**  
For example, if you have connected a CV signal from an envelope generator, the switch should be set to Unipolar. If you are modulating from a standard LFO, the polarity switch should be set to Bipolar.



**Chapter 26**  
**Mixer 14:2**

# Introduction



The Mixer 14:2 allows you to control the level, stereo placement (Pan), tone (EQ) and effect mix (AUX Sends) of each connected audio device.

If you have ever used a conventional hardware audio mixer, you will most likely find the Mixer very straightforward to use. It is configured with 14 (stereo) input channels, which are combined and routed to the Left and Right Master outputs. The vertical channel "strips" are identical and contain - from the top down - four Auxiliary Sends, an EQ section, Mute and Solo buttons, Pan control, and a Level fader.

Every mixer parameter can of course be automated.

## The Channel Strip

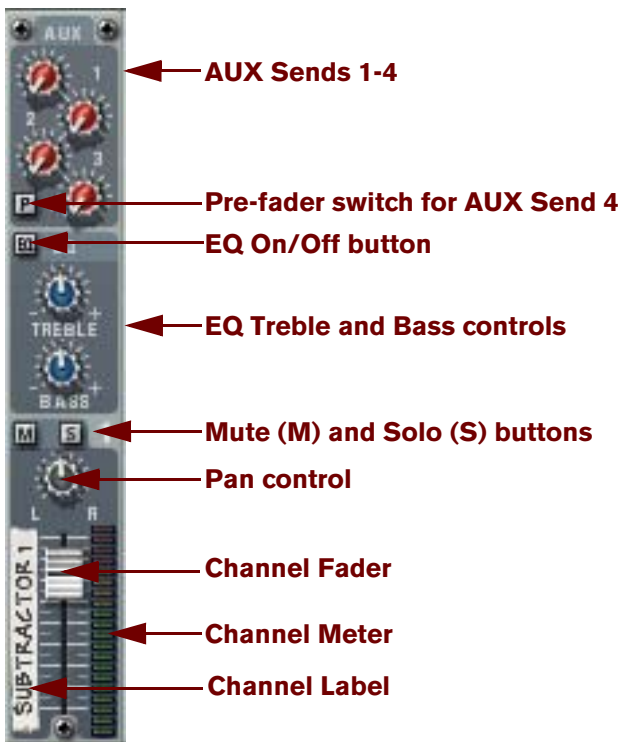

Each channel strip in the Mixer 14:2 contains the items listed in "Channel Strip Controls".

# Channel Strip Controls

Item	Description	Range
Channel Fader	The channel fader is used to control the output level of each corresponding channel. By adjusting the faders, you can set the desired mix (balance) between different devices connected to the Mixer.	0 - 127
Channel Label	Each channel in the mixer that has a device connected to it, displays a read-only label with the name of the device to the left of the fader.	N/A
Channel Meter	The meter is a graphical representation of the channel output level. If the signal level pushes the meter into the range of the red area, try lowering either the output level of the device connected to the channel, or the channel fader itself, to avoid distortion.	N/A
Pan Control	Use this control to set the left/right position of the channel in the stereo field. [Command]/[Ctrl]-click the Pan knob to set Pan to the default "0" (center position).	-64 – 0 – 63
Mute (M) and Solo (S) Buttons	Clicking a channel's Mute button silences the output of that channel. Click the button again to unmute the channel. Clicking a channel's Solo button silences all other mixer channels, so that you only hear the soloed channel. Several channels can be soloed at the same time, but if this is the case, note that soloed channels can't be muted with the Mute button. To mute one of several channels in solo mode you simply "unsolo" it.	On/Off
EQ Treble and Bass controls	The EQ Treble and Bass controls is used to cut or boost the higher and lower frequencies of the signal, respectively. Click on the EQ button to activate the EQ. If you need more advanced EQ, you can always use a PEQ2 parametric EQ as an insert effect for a device. Note also the two EQ modes - see <a href="#">"About the EQ modes"</a> .	Treble: +/- 24 dB at 12 kHz. Bass: +/- 24 dB at 80 Hz.
Auxiliary (AUX) Effect Send 1-4	The four independent AUX Sends control the amount of channel signal that is to be sent to other devices - typically effect processors. The effect output is then normally returned to the Mixer via the AUX Return inputs (see <a href="#">"The Auxiliary Return Section"</a> ) where it is mixed with the dry (non-processed) signal. If you create an effect device when the Mixer is selected, the effect is auto-routed to the first available Send/Return connectors. You can then control the amount of effect that is to be applied to any device connected to a Mixer channel via the corresponding AUX Send knob. The AUX Send outputs are taken post channel fader, but you have the option of selecting Pre-fader mode for AUX Send 4 (by clicking the "P" button next to the send so that it lights up). In that mode, the send level is independent of the channel fader. The sends are in stereo but can be used in mono as well.	0 - 127

# The Mixer signal flow

The basic signal flow for a channel in the Mixer 14:2 is as follows:

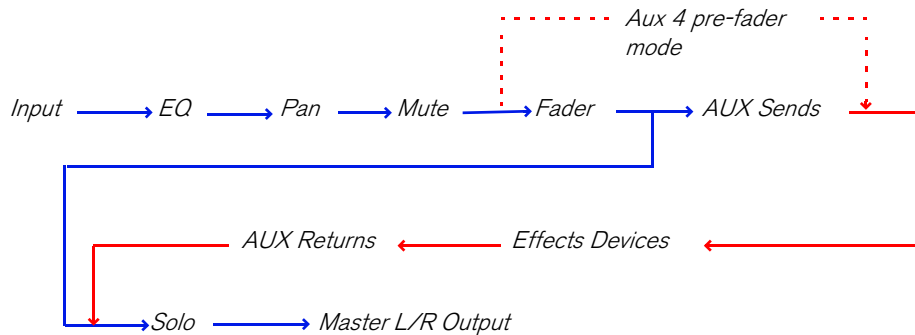

Note that the Solo function is true “in-place” solo, meaning that if the channel uses Auxiliary sends routed to effect devices, the soloed output signal will also include the soloed channel(s) including any Aux Send effects.

Note also that if the pre-fader send mode is activated for Aux 4 the send is tapped after the EQ and Pan controls but before the channel fader.

## About the EQ modes



With Reason 2.5, the EQ modules in the Mixer were improved to get an even better sound and character. However, if you want to play back songs made in previous Reason versions, you may want to use the “old” EQ mode to ensure that the songs sound exactly the same.

On the back of the Mixer 14:2 you will find a switch for this - select “Improved EQ” for the new EQ types or “Compatible EQ” for the old-style EQ. The parameters are exactly the same in both cases.



# The Auxiliary Return Section



The Auxiliary Returns provide an “extra” four stereo inputs in addition to the Mixer 14:2’s 14 stereo channels. The main function of Return channels is to provide inputs for connected Send effects devices. Each Aux Return channel has a level control, and a read-only tape label that display the name of the device connected to the Return channel.

# The Master Fader

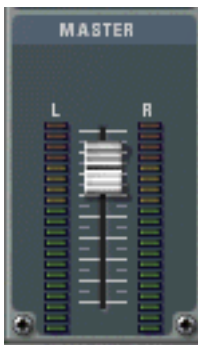

The Master L/R fader controls the summed output level of all channels in the Mixer 14:2. Use this to change the relative level of all channels, to make fade-outs etc.

# Connections

All input and output connectors are as usual located on the back panel of the Mixer 14:2. Special connectors are used for “chaining” two or more Mixer 14:2 devices together. This is described on [“Chaining several Mixer 14:2 devices”](#).

## Mixer Channel Connections

- **Each mixer channel features stereo left/right inputs for connecting audio devices.**  
Use the left input when manually connecting a mono signal source.
- **In addition, there are two Control Voltage (CV) inputs (with associated voltage trim pots), for voltage controlling channel Level and Pan from other devices.**

## Auxiliary (AUX) Send Out



- **There are four stereo Send Out connectors, which normally are used to connect to the inputs of effect devices.** To connect a send to a mono-input device, use the Left (Mono) output.

When a Send is connected to an effects device, the corresponding AUX Send knob determines the level of the signal sent to the effect device for each channel. The Send Output is taken post-channel fader but you have the option of selecting pre-fader mode for AUX Send 4.

- **Note that some effects (for example the Comp-01 compressor or the PEQ2 parametric EQ) are effect types which are not designed to be used as AUX Send effects, but rather as insert effects, where the whole signal is passed through the effect.**

Alternatively, you could use AUX Send 4 in pre-fader mode and lower the channel fader completely.

## Auxiliary (AUX) Returns



- **There are four stereo Return input connectors.** These are normally connected to the left and right outputs of effect devices.

## Master Left/Right Outputs



- **The Master outputs are auto-routed to the input pair of the first available Mix Channel device in the rack.** If no Mix Channel device is available, one will be automatically created when you create a Mixer 14:2 device.
- **In addition to the Master Out connectors, there is a Control Voltage (CV) input (and an associated trim pot), for voltage controlling the Master Level from another device.**

# Chaining several Mixer 14:2 devices



Two chained Mixer 14:2 devices are connected like this, the top Mixer being the “Master” Mixer.

If you want more Mixer channels, you can chain several Mixer 14:2 devices.

- **Select the existing Mixer 14:2 device and choose “Create:Mixer 14:2” from the Create menu or context menu.**  
The new Mixer is automatically connected via the “Chaining Master” and “Chaining Aux” connectors of the selected Mixer.
- **The newly created Mixer’s Master Output is connected to the original Mixer’s Chaining Master input.**  
The Master Out Level for the new Mixer is now controllable from the original Mixer’s Master fader - so that this fader now controls the Master output level of both mixers.
- **The newly created Mixer’s four stereo Aux Send outputs is connected to the original Mixer’s Chaining Aux connectors.**  
The new Mixer will now have access to any Aux Send effects connected to the original Mixer, via the same corresponding Aux Send(s).

This way, the two Mixers operate as “one”.

**! One exception is the Mute/Solo function, which is not chained. Thus, soloing a channel in one of the Mixers, will not mute the channels in the other Mixer.**

You can create as many Mixers as you like, they will be chained in the same way, with one Mixer remaining the “master” (i.e. it controls the Master level of all chained Mixers and supplies the Aux Send effect sources).

## Partially or Non-Chained Mixers

You can also have several Mixers that are only partially or not chained at all.

- **You may for example wish to have different Aux Send effects for one Mixer.**  
Then simply disconnect one or more of the Send Out to Chaining Aux connectors, and assign new Send effects.
- **You could for example send the Master output of one Mixer to another Mix Channel device, instead of the Chaining Master inputs.**



**Chapter 27**  
**The Line Mixer 6:2**

# Introduction



The Line Mixer 6:2 allows you to control the level, stereo placement (Pan) and effect mix (AUX Send) of each connected audio device.

The Line Mixer is configured with 6 (stereo) input channels, which are combined and routed to the Left and Right Master outputs.

## Channel parameters

The channels are identical and contain an Auxiliary Send, Mute and Solo buttons, a Pan control, and a Level control:

Item	Description
Level control	This controls the output level of each corresponding channel, allowing you to set the desired mix (balance) between different devices connected to the Line Mixer.
Channel label	Each channel in the mixer that has a device connected to it, displays a read-only label with the name of the device.
Channel meter	The meter is a graphical representation of the channel output level. If the signal level pushes the meter into the range of the red area, try lowering either the output level of the device connected to the channel, or the Level control itself, to avoid distortion.
Pan control	Use this control to set the left/right position of the channel in the stereo field. [Ctrl]-click (Win) or the Pan knob to set Pan to the default "0" (center position).
Mute (M) and Solo (S) Buttons	Clicking a channel's Mute button silences the output of that channel. Click the button again to unmute the channel. Clicking a channel's Solo button silences all other mixer channels, so that you only hear the soloed channel. Several channels can be soloed at the same time. If this is the case, note that soloed channels can't be muted with the Mute button. To mute one of several channels in solo mode you simply "unsolo" it.
Auxiliary (AUX) Effect Send	The AUX Send controls the amount of channel signal that is to be sent to other devices - typically effect processors. The effect output is then normally returned to the Mixer via the AUX Return input where it is mixed with the dry (non-processed) signal. If you create an effect device when the Mixer is selected, the effect is auto-routed to the Send/Return connectors. You can then control the amount of effect that is to be applied to any device connected to a Line Mixer channel via the AUX Send knob. The Send can be taken pre or post channel level - see " <a href="#">Auxiliary (AUX) Send</a> ".

## The Auxiliary Return section

The AUX Return channels provide inputs for a connected send effect device. The Aux Return channels have a single level control on the front panel.

## Master level

The Master L/R fader controls the summed output level of all channels in the Mixer. Use this to change the relative level of all channels, to make fade-outs etc.

# Connections

All input and output connectors are as usual located on the back panel of the Line Mixer.

## Mixer Channel Connections

- **Each mixer channel features stereo left/right inputs for connecting audio devices.**  
Use the left input when manually connecting a mono signal source.
- **In addition, there is a Control Voltage (CV) input, for voltage controlling channel Pan from other devices.**

## Auxiliary (AUX) Send

- **The Send connectors are used to connect to the inputs of effect devices.**  
To connect the send to a mono-input device, use the Left (Mono) output.

When a Send is connected to an effects device, the corresponding AUX Send knob determines the level of the signal sent to the effect device for each channel.

The Send Output can be taken Pre or Post channel level by using the switch to the left of the Send connectors.

## Auxiliary (AUX) Return

These are normally connected to the left and right outputs of effect devices.

## Master Left/Right Outputs

- **The Master outputs are auto-routed to the input pair of the first available Mix Channel device in the rack.**  
If no Mix Channel device is available, one will be automatically created when you create a Line Mixer device.  
If used in a Combi, the Master Outs are normally connected to the "From Devices" connectors on the Combinator.





# **Chapter 28**

## **ID8 Instrument Device**

# Introduction



The ID8 Instrument device is a synth module packed with great sounds - ideal for quickly creating nice complete arrangements. The sounds have been extracted from various Reason devices and ReFills to guarantee supreme audio quality.

## The Sounds

The ID8 contains 36 presets divided into nine categories, with four sounds in each category. The categories are these:

- **Piano**  
The Piano category features a grand piano, an upright piano, a dance oriented piano sound and vibes.
- **Electric Piano**  
The Electric Piano category holds two classic electric piano sounds plus a digital FM type piano and a Clav.
- **Organ**  
The Organ category contains two classic tone-wheel organ sounds, one transistor organ sound and a pump organ.
- **Guitar**  
The Guitar category sports an acoustic steel string guitar, a clean electric guitar, a half-acoustic jazz guitar and a dulcimer.
- **Bass**  
The Bass category features one fingered and one picked electric bass, an acoustic upright bass and a synth bass.
- **Strings**  
The Strings category holds orchestral strings, arco strings, a small string section and a choir sound.
- **Brass-Wind**  
The Brass-Wind category features Fat Brass, Brass Section, French Horns and Flute.
- **Synth**  
The Synth category contains two classic monophonic synth lead sounds and two characteristic polyphonic pad sounds, one with fast attack and one with slow.
- **Drums**  
The Drums category sports four extensive combinations of drums and percussion instruments aimed at different musical styles. Each "drum kit" contains between 53 and 65 different instruments, so there is plenty to choose from!

See "[Velocity mapping](#)" for information about the velocity mapping of some of the sounds.

## The ID8 and Standard MIDI Files

The ID8 device is used by default when you're loading a Standard MIDI File into the Reason sequencer. For every MIDI track in the imported file, you will get an ID8 device loaded with a sound that resembles the original sound. This serves as a starting point to be able to play back the imported MIDI file. However, you could of course change sound, or replace the ID8 with another instrument device afterwards.

# Using the ID8

## Selecting Sounds

- Select Category by clicking the Up/Down buttons to the left of the Display.



- Select Sound in the selected Category by clicking on any of the A-D buttons, or by clicking on the Sound name in the Display.



- Click on the Category name in the ID8 Display to bring up a pop-up where you can select Category or replace the ID8 device with another device.

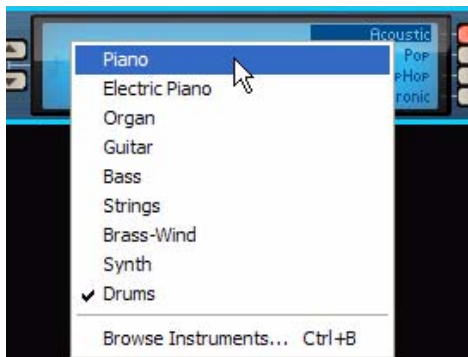

At the bottom of the pop-up, you can also choose “Browse Instruments...”. Selecting this allows you to replace the ID8 device with another instrument device and load a new sound in that device.

## Controlling Sounds

### Parameter knobs



Each of the Sounds in the ID8 have two preset parameters assigned to the Parameter 1 and 2 knobs. The parameter names are shown in the small displays to the right of the corresponding knobs, and are different depending on the selected Sound.

## Pitch Bend and Mod Wheel



To the left on the ID8 front panel are the standard Pitch Bend and Mod Wheel. The Pitch Bend range is +/- 2 semi-tones and is the same for all sounds. The Mod Wheel is assigned a little differently depending on the selected Sound, but usually controls vibrato. In the Drums Category, however, the Mod Wheel has no effect, except on the Electronic Drums where it controls the cutoff frequency of a lowpass filter.

## Performance Controllers

The sounds in the ID8 also respond to the standard Performance controllers “Sustain Pedal”, “Aftertouch”, “Expression” and “Breath Control”. The parameter assignments can be a little different depending on selected sound. However, “Sustain Pedal” always controls sustain and “Expression” always controls volume.

## Velocity mapping

A lot of the sounds in the ID8 are multi-sampled. They also have several velocity layers to faithfully reproduce the original instruments. Some of the sounds also use different types of samples for the highest velocity layer. This means that instead of just sounding louder, they will also sound different. For example, the Jazz Semi Guitar as well as the Finger, Pick and Upright basses have glissando or sliding notes in the highest velocity layer. The Arco Strings have pizzicato (picked) notes in the top velocity layer.

## About saving edited Sounds

Since the ID8 is designed as a “preset” sound module, there is no dedicated function for saving edited Sounds. However, any edits you have made of the parameters in a Sound are automatically stored with the song (document) when you save the song.

- You could also include one or several ID8 Instrument devices in a Combinator device and save the Combinator patch. Doing so will automatically store the settings of the ID8 Parameters in the Combinator patch. See **“The Combinator”** for more details.

# **Chapter 29**

## **Subtractor Synthesizer**

# Introduction

Subtractor is an analog-type polyphonic synthesizer based on subtractive synthesis, the method used in analog synthesizers. This chapter will go through all parameters of each section of Subtractor. In addition to the parameter descriptions, the chapter also includes a few tips and tricks to help you get the most out of the Subtractor synthesizer.

**! It is recommended that you start with default settings (an “Init Patch”) if you intend to follow the examples in this chapter, unless otherwise is stated. An Init Patch is created by selecting “Reset Device” from the device’s context menu, or from the Edit menu. If you wish to keep the current settings, save them before initializing.**

The Subtractor has the following basic features:

→ **Up to 99 Voice Polyphony.**

You can set the number of voices for each Patch.

→ **Dual Filters.**

A combination of a multimode filter and a second, linkable, lowpass filter allows for complex filtering effects. See [“The Filter Section”](#).

→ **Two Oscillators, each with 32 waveforms.**

See [“The Oscillator Section”](#).

→ **Frequency Modulation (FM).**

See [“Frequency Modulation \(FM\)”](#).

→ **Oscillator Phase Offset Modulation.**

This is a unique Subtractor feature that generates waveform variations. See [“Phase Offset Modulation”](#).

→ **Two Low Frequency Oscillators (LFO’s)**

See [“LFO Section”](#).

→ **Three Envelope Generators.**

See [“Envelopes - General”](#).

→ **Extensive Velocity Control.**

See [“Velocity Control”](#).

→ **Extensive CV/Gate Modulation possibilities.**

See [“Connections”](#).

## Loading and Saving Patches

Loading and saving patches is done in the same way as with any other Reason device - see [“Loading patches”](#) and [“Saving patches”](#).

# The Oscillator Section



Subtractor provides two oscillators. Oscillators are the main sound generators in Subtractor, the other features are used to shape the sound of the oscillators. Oscillators generate two basic properties, waveform and pitch (frequency). The type of waveform the oscillator produces determines the harmonic content of the sound, which in turn affects the resultant sound quality (timbre). Selecting a oscillator waveform is usually the starting point when creating a new Subtractor Patch from scratch.

## Oscillator 1 Waveform







Oscillator 1 provides 32 waveforms. The first four are standard waveforms, and the rest are “special” waveforms, some of which are suitable for emulating various musical instrument sounds.

- It is worth noting here that all waveforms can be radically transformed using Phase offset modulation (see **“Phase Offset Modulation”**).
- To select a waveform, click the spin controls to the right of the “Waveform” LED display.  
The first 4 basic waveforms are shown as standard symbols, and the special waveforms are numbered 5 - 32.

Here follows a brief description of the Subtractor waveforms:

**! Please note that the descriptions of the waveforms sound or timbre is merely meant to provide a basic guideline, and shouldn't be taken too literally. Given the myriad ways you can modulate and distort a waveform in Subtractor, you can produce extremely different results from any given waveform.**

Waveform	Description
Sawtooth 	This waveform contains all harmonics and produces a bright and rich sound. The Sawtooth is perhaps the most "general purpose" of all the available waveforms.
Square 	A square wave only contains odd number harmonics, which produces a distinct, hollow sound.
Triangle 	The Triangle waveform generates only a few harmonics, spaced at odd harmonic numbers. This produces a flute-like sound, with a slightly hollow character.
Sine 	The sine wave is the simplest possible waveform, with no harmonics (overtones). The sine wave produces a neutral, soft timbre.
5	This waveform emphasizes the higher harmonics, a bit like a sawtooth wave, only slightly less bright-sounding.
6	This waveform features a rich, complex harmonic structure, suitable for emulating the sound of an acoustic piano.
7	This waveform generates a glassy, smooth timbre. Good for electric piano-type sounds.
8	This waveform is suitable for keyboard-type sounds such as harpsichord or clavinet.
9	This waveform is suitable for electric bass-type sounds.
10	This is a good waveform for deep, sub-bass sounds.
11	This produces a waveform with strong formants, suitable for voice-like sounds.
12	This waveform produces a metallic timbre, suitable for a variety of sounds.
13	This produces a waveform suitable for organ-type sounds.
14	This waveform is also good for organ-type sounds. Has a brighter sound compared to waveform 13.
15	This waveform is suitable for bowed string sounds, like violin or cello.
16	Similar to 15, but with a slightly different character.
17	Another waveform suitable for string-type sounds.
18	This waveform is rich in harmonics and suitable for steel string guitar-type sounds.
19	This waveform is suitable for brass-type sounds.
20	This waveform is suitable for muted brass-type sounds.
21	This waveform is suitable for saxophone-like sounds.
22	A waveform suitable for brass and trumpet-type sounds.
23	This waveform is good for emulating mallet instruments such as marimba.
24	Similar to 23, but with a slightly different character.
25	This waveform is suitable for guitar-type sounds.
26	This is a good waveform for plucked string sounds, like harp.
27	Another waveform suitable for mallet-type sounds (see 23-24), but has a brighter quality, good for vibraphone-type sounds.



Waveform	Description
28	Similar to 27, but with a slightly different character.
29	This waveform has complex, enharmonic overtones, suitable for metallic bell-type sounds.
30	Similar to 29, but with a slightly different character. By using FM and setting the Osc Mix to Osc 1, this and the following two waveforms can produce noise.
31	Similar to 30, but with a slightly different character.
32	Similar to 30, but with a slightly different character.

## Setting Oscillator 1 Frequency - Octave/Semitone/Cent



By clicking the corresponding up/down buttons you can tune, i.e. change the frequency of Oscillator 1 in three ways:

- **In Octave steps**  
The range is 0 - 9. The default setting is 4 (where “A” above middle “C” on your keyboard generates 440 Hz).
- **In Semitone steps**  
Allows you to raise the frequency in 12 semitone steps (1 octave).
- **In Cent steps (100th of a semitone)**  
The range is -50 to 50 (down or up half a semitone).

## Oscillator Keyboard Tracking

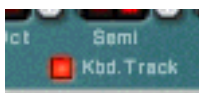

Oscillator 1 has a button named “Kbd. Track”. If this is switched off, the oscillator pitch will remain constant, regardless of any incoming note pitch messages, although the oscillator still reacts to note on/off messages. This can be useful for certain applications:

- **When Frequency Modulation (FM - see “[Frequency Modulation \(FM\)](#)”) or Ring Modulation (see “[Ring Modulation](#)”) is used.**  
This produces enharmonic sounds with very varying timbre across the keyboard.
- **For special effects and non-pitched sounds (like drums or percussion) that should sound the same across the keyboard.**

## Using Oscillator 2



You activate Osc 2 by clicking the button next to the text “Osc 2”. Setting oscillator frequency and keyboard tracking is identical to Oscillator 1.

Adding a second oscillator enables many new modulation possibilities which can produce richer timbres. A basic example is to slightly detune (+/- a few cents) one of the oscillators. This slight frequency offset causes the oscillators to “beat” against each other, producing a wider and richer sound. Also, by combining two different waveforms, and adding frequency or ring modulation, many new timbres can be created.

## Oscillator Mix



The Osc Mix knob determines the output balance between Osc 1 and Osc 2. To be able to clearly hear both oscillators, the “Osc Mix” knob should be set somewhere around the center position. If you turn the Mix knob fully to the left, only Osc 1 will be heard, and vice versa. [Command]/[Ctrl]-clicking the knob sets the Mix parameter to center position.

## Oscillator 2 Waveform

The waveform alternatives for Oscillator 2 are identical to those of Oscillator 1.

However, the Noise Generator provides a third sound generating source (in addition to the two oscillators) in Subtractor, and could be regarded as an “extra” waveform for Oscillator 2, as it is internally routed to the Oscillator 2 output. See below for a description of the Noise Generator.

## Noise Generator



The Noise Generator could be viewed as an oscillator that produces noise instead of a pitched waveform. Noise can be used to produce a variety of sounds, the classic example being “wind” or “rolling wave” sounds, where noise is passed through a filter while modulating the filter frequency. Other common applications include non-pitched sounds like drums and percussion, or simulating breath noises for wind instruments. To use the Noise Generator, select an Init Patch and proceed as follows:

**1. Turn Osc 2 off.**

**2. Click the button (in the Noise Generator section) to activate the Noise Generator.**

If you play a few notes on your MIDI instrument you should now hear Osc1 mixed with the sound of the Noise Generator.

**3. Turn the Mix knob fully to the right, and play a few more notes.**

Now just the Noise Generator will be heard.

→ **Thus, the output of the Noise Generator is internally routed to Osc 2.**

If you switch Osc 2 on, the noise will be mixed with the Osc 2 waveform.

There are three Noise Generator parameters. These are as follows:

Parameter	Description
Noise Decay	This controls how long it takes for the noise to fade out when you play a note. Note that this is independent from the Amp Envelope Decay parameter, allowing you to mix a short “burst” of noise at the very beginning of a sound, i.e. a pitched sound that uses oscillators together with noise.
Noise Color	This parameter allows you to vary the character of the noise. If the knob is turned fully clockwise, pure or “white” noise (where all frequencies are represented with equal energy) is generated. Turning the knob anti-clockwise produces a gradually less bright sounding noise. Fully anti-clockwise the noise produced is an earthquake-like low frequency rumble.
Level	Controls the level of the Noise Generator.

## Phase Offset Modulation

A unique feature of the Subtractor oscillators is the ability to create an extra waveform within one oscillator, to offset the *phase* of that extra waveform, and to modulate this phase offset. By subtracting or multiplying a waveform with a phase offset copy of itself, very complex waveforms can be created. Sounds complicated? Well, the theory behind it might be, but from a user perspective it is just a method of generating new waveforms from existing waveforms.

A seasoned synth programmer using Subtractor for the first time may wonder why the Subtractor oscillators (seemingly) cannot provide the commonly used pulse waveform and the associated pulse width modulation (PWM). Or oscillator sync, another common feature in analog synthesizers. The simple answer is that Subtractor can easily create pulse waveforms (with PWM) and oscillator sync-sounds, and a lot more besides, partly by the use of phase offset modulation.



Each oscillator has its own Phase knob and a selector button. The Phase knob is used to set the amount of phase offset, and the selector switches between three modes:

- **Waveform multiplication (x)**
- **Waveform subtraction (-)**
- **No phase offset modulation (o).**

When phase offset modulation is activated, the oscillator creates a *second* waveform of the same shape and offsets it by the amount set with the Phase knob. Depending on the selected mode, Subtractor then either subtracts or multiplies the two waveforms with each other. The resulting waveforms can be seen in the illustration below.

1. The two offset waveforms:

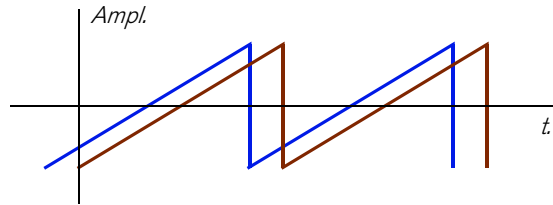

2. The result of subtraction:

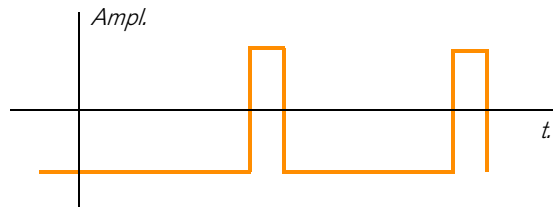

3. The result of multiplication:

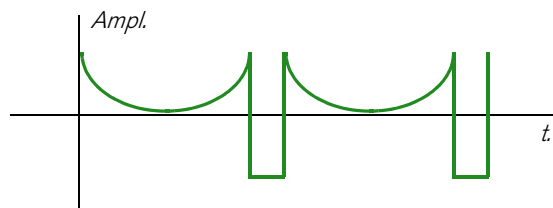

- In example 1, we see two sawtooth waves with a slight offset.
- Example 2 shows that subtracting one slightly offset sawtooth wave from the other, produces a pulse wave. If you modulate the Phase offset parameter (with for example an LFO), the result will be pulse width modulation (PWM).
- Example 3 shows the resulting waveform when multiplying the offset waves with each other. As you can see (and hear if you try it), multiplying waveforms can produce very dramatic and sometimes unexpected results.

Using phase offset modulation can create very rich and varied timbres, especially when used along with LFO or Envelopes to modulate the phase offset.

- To get a “feel” for this concept, you could study Patches that use phase offset modulation, and maybe tweak some of the Phase Offset parameters to find out what happens. Try “SyncedUp” in the Polysynth category in the Factory Soundbank for an example of osc sync or “Sweeping Strings” (in the Pads category) for an example of PWM.
- ! Note that if you activate waveform subtraction with a Phase offset set to “0” for an oscillator, the second waveform will cancel out the original waveform completely, and the oscillator output will be silent. If you set the Phase Offset knob to any other value than zero, the sound returns.

# Frequency Modulation (FM)



In synthesizer-speak, Frequency Modulation, or FM, is when the frequency of one oscillator (called the “carrier”) is modulated by the frequency of another oscillator (called the “modulator”). Using FM can produce a wide range of harmonic and non harmonic sounds. In Subtractor, Osc 1 is the carrier and Osc 2 the modulator. To try out some of the effects FM can produce, proceed as follows:

**1. Select an Init Patch by selecting “Initialize Patch” from the Edit menu.**

**2. Activate Osc 2.**

As you need both a carrier and a modulator to produce FM, turning the FM knob will not produce any effect unless you first activate Osc 2. For classic FM sounds, use sine wave on oscillator 1 and triangle wave on oscillator 2.

**3. Use the FM knob to set the FM amount to a value of about 50.**

As you can hear, the timbre changes, but the effect isn't very pronounced yet.

**4. Turn the Osc Mix knob fully to the left, so that only the sound of Osc 1 is heard.**

The modulator (Osc 2) still affects Osc 1, even though the Osc 2 output is muted.

**5. Now, hold down a note on your MIDI keyboard and tune Osc 2 a fifth up from the original pitch by setting the Osc 2 frequency “Semi” parameter to a value of 7.**

As you can hear, for each semitone step you vary the Osc 2 frequency, the timbre changes dramatically. Setting Osc 2 frequency to certain musical intervals (i.e. fourth, fifth or octave semitone steps) produces harmonic, rich timbres, almost like tube distortion. Setting Osc 2 to non-musical intervals usually results in complex, enharmonic timbres.

➤ **Experiment with different oscillator parameters such as phase offset modulation, changing the waveforms etc. and listen to how they affect the sound of frequency modulation.**

## Using the Noise Generator as the Modulator source

As explained earlier, the Noise Generator is internally routed to the Osc 2 output. Hence, if you deactivate Osc 2, and activate the Noise Generator while using FM, the noise will be used to frequency modulate Osc 1.

➤ **With the Noise Generators default settings, this will sound much like colored noise. But by changing (lowering) the Noise Generator Decay parameter, so that the noise modulates only the attack portion of the sound can produce more interesting results. You could also use a combination of noise and Osc 2.**

# Ring Modulation



Ring Modulators basically multiply two audio signals together. The ring modulated output contains added frequencies generated by the sum of, and the difference between, the frequencies of the two signals. In the Subtractor Ring Modulator, Osc 1 is multiplied with Osc 2 to produce sum and difference frequencies. Ring modulation can be used to create complex and enharmonic, bell-like sounds.

**1. Select an Init Patch by selecting “Initialize Patch” from the Edit menu.**

Save any current settings you wish to keep before initializing.

**2. Activate Ring Modulation with the button in the lower right corner of the oscillator section.**

**3. Activate Osc 2.**

You need to activate Osc 2 before any ring modulation can happen.

**4. Turn the Osc Mix knob fully to the right, so that only the sound of Osc 2 is heard.**

Osc 2 provides the ring modulated output.

**5. If you play a few notes while varying the frequency of either oscillator, by using the Semitone spin controls, you can hear that the timbre changes dramatically.**

If the oscillators are tuned to the same frequency, and no modulation is applied to either the Osc 1 or 2 frequency, the Ring Modulator won't do much. It is when the frequencies of Osc 1 and Osc 2 differ, that you get the “true” sound of ring modulation.

# The Filter Section



In subtractive synthesis, a filter is the most important tool for shaping the overall timbre of the sound. The filter section in Subtractor contains two filters, the first being a multimode filter with five filter types, and the second being a low-pass filter. The combination of a multimode filter and a lowpass filter can be used to create very complex filter effects.

## Filter 1 Type

With this multi-selector you can set Filter 1 to operate as one of five different types of filter. The five types are illustrated and explained on the following pages:

- **24 dB Lowpass (LP 24)**

Lowpass filters lets low frequencies pass and cuts out the high frequencies. This filter type has a fairly steep roll-off curve (24dB/Octave). Many classic synthesizers (Minimoog/Prophet 5 etc.) use this filter type.

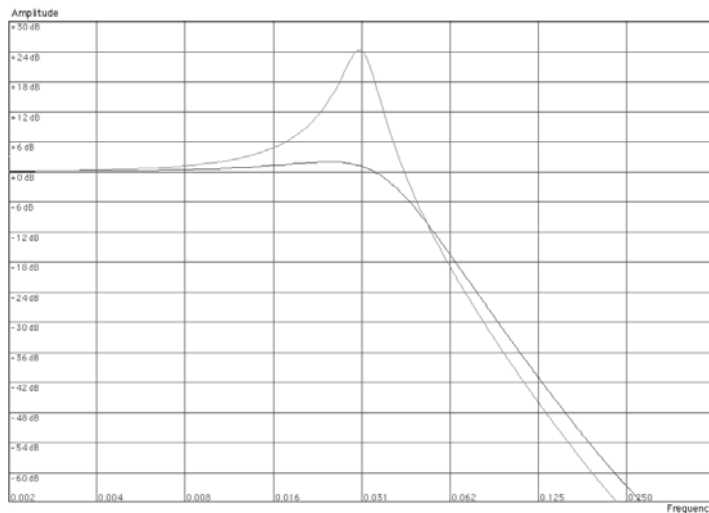

*The darker curve illustrates the roll-off curve of the 24dB Lowpass Filter. The lighter curve in the middle represents the filter characteristic when the Resonance parameter is raised.*

- **12 dB Lowpass (LP 12)**

This type of lowpass filter is also widely used in analog synthesizers (Oberheim, early Korg synths etc.). It has a gentler slope (12 dB/Octave), leaving more of the harmonics in the filtered sound compared to the LP 24 filter.

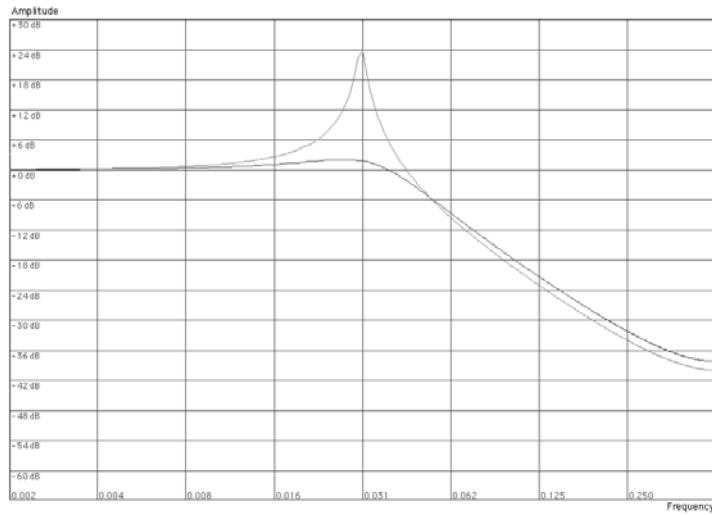

*The darker curve illustrates the roll-off curve of the 12dB Lowpass Filter. The lighter curve in the middle represents the filter characteristic when the Resonance parameter is raised.*

- **Bandpass (BP 12)**

A bandpass filter cuts both high and low frequencies, while midrange frequencies are not affected. Each slope in this filter type has a 12 dB/Octave roll-off.

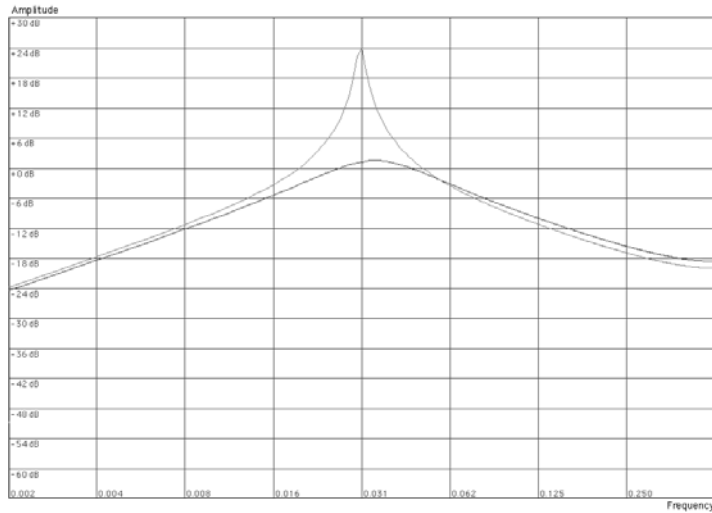

*The darker curve illustrates the roll-off curve of the Bandpass Filter. The lighter curve in the middle represents the filter characteristic when the Resonance parameter is raised.*



- **Highpass (HP12)**

A highpass filter is the opposite of a lowpass filter, cutting out lower frequencies and letting high frequencies pass. The HP filter slope has a 12 dB/Octave roll-off.

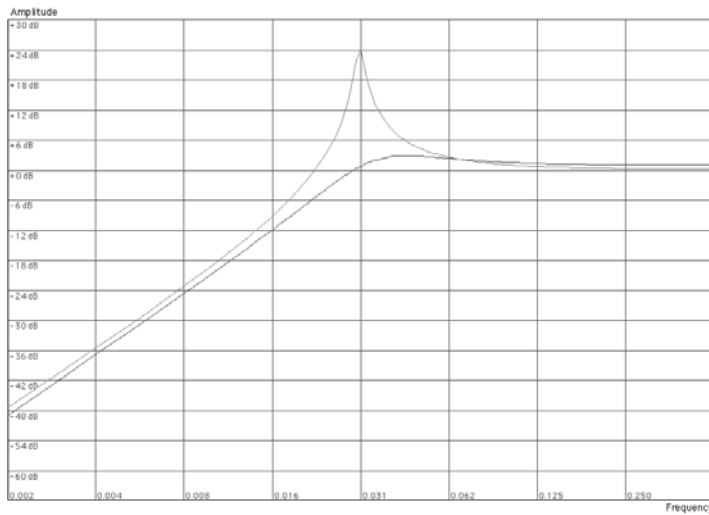

*The darker curve illustrates the roll-off curve of the Highpass Filter. The lighter curve in the middle represents the filter characteristic when the Resonance parameter is raised.*

- **Notch**

A notch filter (or band reject filter) could be described as the opposite of a bandpass filter. It cuts off frequencies in a narrow midrange band, letting the frequencies below and above through. On its own, a notch filter doesn't really alter the timbre in any dramatic way, simply because most frequencies are let through. However, by combining a notch filter with a lowpass filter (using Filter 2 - see "Filter 2"), more musically useful filter characteristics can be created. Such a filter combination can produce soft timbres that still sound "clear". The effect is especially noticeable with low resonance (see "Resonance") settings.

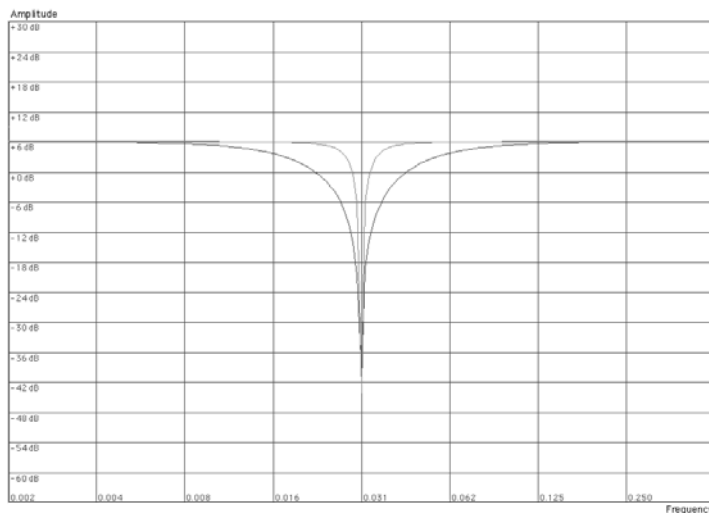

*The darker curve illustrates the roll-off curve of the Notch Filter. The lighter curve in the middle represents the filter characteristic when the Resonance parameter is raised.*

## Filter 1 Frequency

The Filter Frequency parameter (often referred to as “cutoff”) determines which area of the frequency spectrum the filter will operate in. For a lowpass filter, the frequency parameter could be described as governing the “opening” and “closing” of the filter. If the Filter Freq is set to zero, none or only the very lowest frequencies are heard, if set to maximum, all frequencies in the waveform are heard. Gradually changing the Filter Frequency produces the classic synthesizer filter “sweep” sound.

**! Note that the Filter Frequency parameter is usually controlled by the Filter Envelope (see “Filter Envelope”) as well. Changing the Filter Frequency with the Freq slider may therefore not produce the expected result.**

## Resonance

The filter resonance parameter is used to set the Filter characteristic, or quality. For lowpass filters, raising the filter Res value will emphasize the frequencies around the set filter frequency. This produces a generally thinner sound, but with a sharper, more pronounced filter frequency “sweep”. The higher the filter Res value, the more resonant the sound becomes until it produces a whistling or ringing sound. If you set a high value for the Res parameter and then vary the filter frequency, this will produce a very distinct sweep, with the ringing sound being very evident at certain frequencies.

- **For the highpass filter, the Res parameter operates just like for the lowpass filters.**
- **When you use the Bandpass or Notch filter, the Resonance setting adjusts the width of the band. When you raise the Resonance, the band where frequencies are let through (Bandpass), or cut (Notch) will become narrower. Generally, the Notch filter produces more musical results using low resonance settings.**

## Filter Keyboard Track (Kbd)

If Filter Keyboard Track is activated, the filter frequency will increase the further up on the keyboard you play. If a lowpass filter frequency is constant (a Kbd setting of “0”) this can introduce a certain loss of “sparkle” in a sound the higher up the keyboard you play, because the harmonics in the sound are progressively being cut. By using a degree of Filter Keyboard Tracking, this can be compensated for.

## Filter 2

A very useful and unusual feature of the Subtractor Synthesizer is the presence of an additional 12dB/Oct lowpass filter. Using two filters together can produce many interesting filter characteristics, that would be impossible to create using a single filter, for example formant effects.

The parameters are identical to Filter 1, except in that the filter type is fixed, and it does not have filter keyboard tracking.

### → To activate Filter 2, click the button at the top of the Filter 2 section.

Filter 1 and Filter 2 are connected in series. This means that the output of Filter 1 is routed to Filter 2, but both filters function independently. For example, if Filter 1 was filtering out most of the frequencies, this would leave Filter 2 very little to “work with”. Similarly, if Filter 2 had a filter frequency setting of “0”, all frequencies would be filtered out regardless of the settings of Filter 1.



- Try the “Singing Synth” patch (in the Monosynth category of the Factory Sound Bank) for an example of how dual filters can be used.

## Filter Link



When Link (and Filter 2) is activated, the Filter 1 frequency controls the frequency offset of Filter 2. That is, if you have set different filter frequency values for Filter 1 and 2, changing the Filter 1 frequency will also change the frequency for Filter 2, but keeping the relative offset.

- Try the “Fozzy Fonk” patch (in the Polysynth category of the Factory Sound Bank) for an example how linked filters can be used.
- ! **Caution! If no filter modulation is used, and the filters are linked, pulling down the frequency of Filter 2 to zero will cause both filters to be set to the same frequency. If combined with high Res settings, this can produce very loud volume levels that cause distortion!**

# Envelopes - General

Envelope generators are used to control several important sound parameters in analog synthesizers, such as pitch, volume, filter frequency etc. Envelopes govern how these parameters should respond over time - from the moment a note is struck to the moment it is released.

Standard synthesizer envelope generators have four parameters; Attack, Decay, Sustain and Release (ADSR).

There are three envelope generators in the Subtractor, one for volume, one for the Filter 1 frequency, and one modulation envelope which has selectable modulation destinations.

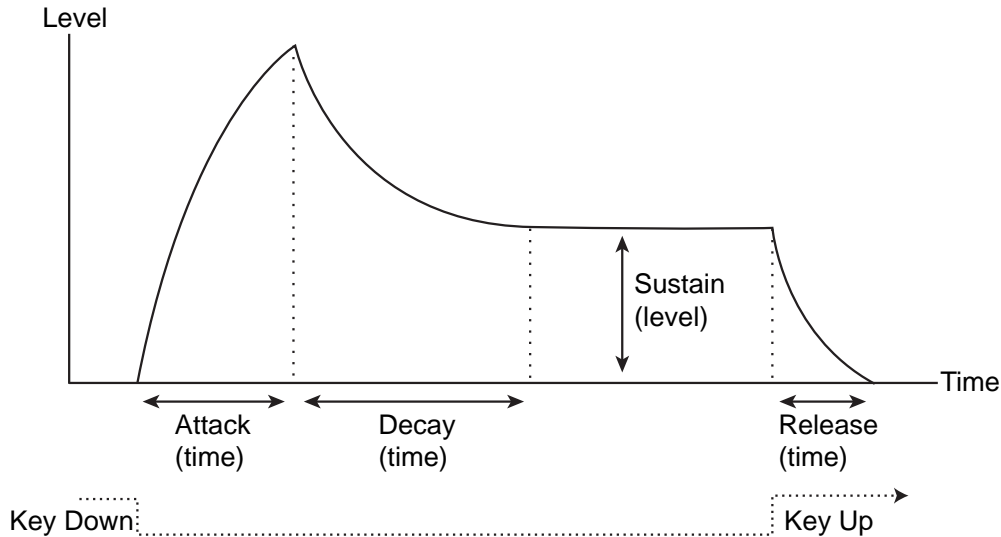

*The ADSR envelope parameters.*

## Attack

When you play a note on your keyboard, the envelope is triggered. This means it starts rising from zero to the maximum value. How long this should take, depends on the Attack setting. If the Attack is set to "0", the maximum value is reached instantly. If this value is raised, it will take time before the maximum value is reached.

For example, if the Attack value is raised and the envelope is controlling the filter frequency, the filter frequency will gradually rise up to a point each time a key is pressed, like an "auto-wha" effect.

## Decay

After the maximum value has been reached, the value starts to drop. How long this should take is governed by the Decay parameter.

If you wanted to emulate the volume envelope of a note played on a piano for example, the Attack should be set to "0" and the Decay parameter should be set to a medium value, so that the volume gradually decreases down to silence, even if you keep holding the key down. Should you want the decay to drop to some other value than zero, you use the Sustain parameter.

## Sustain

The Sustain parameter determines the level the envelope should rest at, after the Decay. If you set Sustain to full level, the Decay setting is of no importance since the volume of the sound is never lowered.

If you wanted to emulate the volume envelope of an organ, you theoretically only really need to use the Sustain parameter set to full level, as a basic organ volume envelope instantly goes to the maximum level (Attack “0”) and stays there (Decay “0”), until the key is released and the sound instantly stops (Release “0”).

But often a combination of Decay and Sustain is used to generate envelopes that rise up to the maximum value, then gradually decreases to finally land to rest on a level somewhere in-between zero and maximum. Note that Sustain represents a *level*, whereas the other envelope parameters represent times.

## Release

Finally, we have the Release parameter. This works just like the Decay parameter, except it determines the time it takes for the value to fall back to zero *after* releasing the key.

## Amplitude Envelope

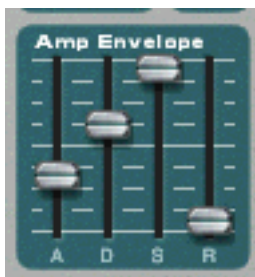

The Amplitude Envelope is used to adjust how the volume of the sound should change from the time you press a key until the key is released. By setting up a volume envelope you sculpt the sound's basic shape with the four Amplitude Envelope parameters, Attack, Decay, Sustain and Release. This determines the basic character of the sound (soft, long, short etc.).

## Filter Envelope



The Filter Envelope affects the Filter 1 Frequency parameter. By setting up a filter envelope you control the how the filter frequency should change over time with the four Filter Envelope parameters, Attack, Decay, Sustain and Release.

## Filter Envelope Amount

This parameter determines to what degree the filter will be affected by the Filter Envelope. Raising this knob's value creates more drastic results. The Envelope Amount parameter and the set Filter Frequency are related. If the Filter Freq slider is set to around the middle, this means that the moment you press a key the filter is already halfway open. The set Filter Envelope will then open the filter further from this point. The Filter Envelope Amount setting affects how much further the filter will open.

## Filter Envelope Invert



If this button is activated, the envelope will be inverted. For example, normally the Decay parameter lowers the filter frequency, but after activating Invert it will instead raise it, by the same amount.

## Mod Envelope



The Mod Envelope allows you to select one of a number of parameters, or Destinations, to control with the envelope. By setting up a modulation envelope you control the how the selected Destination parameter should change over time with the four Mod Envelope parameters, Attack, Decay, Sustain and Release.

The available Mod Envelope Destinations are as follows:

Destination	Description
Osc 1	Selecting this makes the Mod Envelope control the pitch (frequency) of Osc 1.
Osc 2	Same as above, but for Osc 2.
Osc Mix	Selecting this makes the Mod Envelope control the oscillator Mix parameter. Both oscillators must be activated for this to have any effect.
FM	Selecting this makes the Mod Envelope control the FM Amount parameter. Both oscillators must be activated for this to have any effect.
Phase	Selecting this makes the Mod Envelope control the Phase Offset parameter for both Osc 1 and 2. Note that Phase Offset Modulation (Subtraction or Multiplication) must be activated for this to have any effect.
Freq 2	Selecting this makes the Mod Envelope control the Frequency parameter for Filter 2.

# LFO Section



LFO stands for Low Frequency Oscillator. LFO's are oscillators, just like Osc 1 & 2, in that they also generate a waveform and a frequency. However, there are two significant differences:

- **LFOs only generate waveforms with low frequencies.**
- **The output of the two LFO's are never actually heard. Instead they are used for modulating various parameters.**

The most typical application of an LFO is to modulate the pitch of a (sound generating) oscillator, to produce vibrato. Subtractor is equipped with two LFO's. The parameters and the possible modulation destinations vary somewhat between LFO 1 and LFO 2.

## LFO 1 Parameters

### Waveform

LFO 1 allows you to select different waveforms for modulating parameters. These are (from top to bottom):

Waveform	Description
Triangle	This is a smooth waveform, suitable for normal vibrato.
Inverted Sawtooth	This produces a "ramp up" cycle. If applied to an oscillator's frequency, the pitch would sweep up to a set point (governed by the Amount setting), after which the cycle immediately starts over.
Sawtooth	This produces a "ramp down" cycle, the same as above but inverted.
Square	This produces cycles that abruptly changes between two values, usable for trills etc.
Random	Produces random stepped modulation to the destination. On some vintage synths, this is called "sample & hold".
Soft Random	The same as above, but with smooth modulation.

### Destination

The available LFO 1 Destinations are as follows:

Destination	Description
Osc 1&2	Selecting this makes LFO 1 control the pitch (frequency) of Osc 1 and Osc 2.
Osc 2	Same as above, but for Osc 2.
Filter Freq	Selecting this makes the LFO 1 control the filter frequency for Filter 1 (and Filter 2 if linked).
FM	Selecting this makes the LFO 1 control the FM Amount parameter. Both oscillators must be activated for this to have any effect.
Phase	Selecting this makes the LFO 1 control the Phase Offset parameter for both Osc 1 and 2. Note that Phase Offset Modulation (Subtraction or Multiplication) must be activated for this to have any effect.
Osc Mix	Selecting this makes the LFO 1 control the oscillator Mix parameter.

## Sync

By clicking this button you activate/deactivate LFO sync. The frequency of the LFO will then be synchronized to the song tempo, in one of 16 possible time divisions. When sync is activated, the Rate knob (see below) is used for setting the desired time division.

Turn the knob and check the tooltip for an indication of the time division.



## Rate

The Rate knob controls the LFO's frequency. Turn clockwise for a faster modulation rate.

## Amount

This parameter determines to what degree the selected parameter destination will be affected by LFO 1. Raising this knob's value creates more drastic results.

## LFO 2 Parameters

LFO 2 is polyphonic. This means that for every note you play, an *independent* LFO cycle is generated, whereas LFO 1 always modulates the destination parameter using the same "cycle". This can be used to produce subtle cross-modulation effects, with several LFO cycles that "beat" against each other. This also enables LFO 2 to produce modulation rates that vary across the keyboard (see the "Keyboard Tracking" parameter below).

## Destination

The available LFO 2 Destinations are as follows:

Destination	Description
Osc 1 & 2	Selecting this makes LFO 2 modulate the pitch (frequency) of Osc 1 and Osc 2.
Phase	Selecting this makes the LFO 2 modulate the Phase Offset parameter for both Osc 1 and 2. Note that Phase Offset Modulation (Subtraction or Multiplication) must be activated for this to have any effect.
Filter Freq 2	Selecting this makes the LFO 2 modulate the filter frequency for Filter 2.
Amp	Selecting this makes the LFO 2 modulate the overall volume, to create tremolo-effects.

## LFO 2 Delay

This parameter is used to set a delay between when a note is played and when the LFO modulation "kicks in". For example, if Osc 1 & 2 is selected as the destination parameter and Delay was set to a moderate value, the sound would start out unmodulated, with the vibrato only setting in if you hold the note(s) long enough. Delayed LFO modulation can be very useful, especially if you are playing musical instrument-like sounds like violin or flute. Naturally it could also be used to control more extreme modulation effects and still retain the "playability" of the sound.

## LFO 2 Keyboard Tracking

If LFO keyboard tracking is activated, the LFO rate will progressively increase the higher up on the keyboard you play. Raising this value creates more drastic results.



- If the LFO is set to modulate the phase offset, LFO keyboard tracking can produce good results. For example, synth string pads and other sounds that use PWM (see “**Phase Offset Modulation**”) can benefit from this.

## Rate

The Rate knob controls the LFO's frequency. Turn clockwise for a faster modulation rate.

## Amount

This parameter determines to what degree the selected parameter destination will be affected by LFO 2. Raising this knob's value creates more drastic results.

# Play Parameters

This section deals with two things: Parameters that are affected by how you play, and modulation that can be applied manually with standard MIDI keyboard controls.

These are:

- **Velocity Control**
- **Pitch Bend and Modulation Wheel**
- **Legato**
- **Portamento**
- **Polyphony**

## Velocity Control



Velocity is used to control various parameters according to how hard or soft you play notes on your keyboard. A common application of velocity is to make sounds brighter and louder if you strike the key harder. Subtractor features very comprehensive velocity modulation capabilities. By using the knobs in this section, you can control how much the various parameters will be affected by velocity. The velocity sensitivity amount can be set to either positive or negative values, with the center position representing no velocity control.

The following parameters can be velocity controlled:

Destination	Description
Amp	This lets you velocity control the overall volume of the sound. If a positive value is set, the volume will increase the harder you strike a key. A negative value inverts this relationship, so that the volume decreases if you play harder, and increases if you play softer. If set to zero, the sound will play at a constant volume, regardless of how hard or soft you play.
FM	This sets velocity control for the FM Amount parameter. A positive value will increase the FM amount the harder you play. Negative values invert this relationship.
M. Env	This sets velocity control for the Mod Envelope Amount parameter. A positive value will increase the envelope amount the harder you play. Negative values invert this relationship.
Phase	This sets velocity control for the Phase Offset parameter. This applies to both Osc 1 & 2, but the relative offset values are retained. A positive value will increase the phase offset the harder you play. Negative values invert this relationship.
Freq 2	This sets velocity control for the Filter 2 Frequency parameter. A positive value will increase the filter frequency the harder you play. Negative values invert this relationship.
F. Env	This sets velocity control for the Filter Envelope Amount parameter. A positive value will increase the envelope amount the harder you play. Negative values invert this relationship.
F. Dec	This sets velocity control for the Filter Envelope Decay parameter. A positive value will increase the Decay time the harder you play. Negative values invert this relationship.
Osc Mix	This sets velocity control for the Osc Mix parameter. A positive value will increase the Osc 2 Mix amount the harder you play. Negative values invert this relationship.
A. Attack	This sets velocity control for the Amp Envelope Attack parameter. A positive value will increase the Attack time the harder you play. Negative values invert this relationship.

## Pitch Bend and Modulation Wheels



The Pitch Bend wheel is used for “bending” notes, like bending the strings on a guitar. The Modulation wheel can be used to apply various modulation while you are playing. Virtually all MIDI keyboards have Pitch Bend and Modulation controls. Subtractor features not only the settings for how incoming MIDI Pitch Bend and Modulation wheel messages should affect the sound. Subtractor also has two functional wheels that could be used to apply real time modulation and pitch bend should you not have these controllers on your keyboard, or if you aren't using a keyboard at all. The Subtractor wheels mirror the movements of the MIDI keyboard controllers.

### Pitch Bend Range

The Range parameter sets the amount of pitch bend when the wheel is turned fully up or down. The maximum range is “24” (=up/down 2 Octaves).

## Modulation Wheel

The Modulation wheel can be set to simultaneously control a number of parameters. You can set positive or negative values, just like in the Velocity Control section. The following parameters can be affected by the modulation wheel:

Parameter	Description
F. Freq	This sets modulation wheel control of the Filter 1 Frequency parameter. A positive value will increase the frequency if the wheel is pushed forward. Negative values invert this relationship.
F. Res	This sets modulation wheel control of the Filter 1 Resonance parameter. A positive value will increase the resonance if the wheel is pushed forward. Negative values invert this relationship.
LFO 1	This sets modulation wheel control of the LFO 1 Amount parameter. A positive value will increase the Amount if the wheel is pushed forward. Negative values invert this relationship.
Phase	This sets modulation wheel control of the Phase Offset parameter for both Osc 1 and 2. Note that Phase Offset Modulation (Subtraction or Multiplication) must be activated for this to have any effect.
FM	This sets modulation wheel control of the FM Amount parameter. A positive value will increase the FM amount if the wheel is pushed forward. Negative values invert this relationship. Both oscillators must be activated for this to have any effect.

## Legato

Legato works best with monophonic sounds. Set Polyphony (see below) to 1 and try the following:

- **Hold down a key and press another key without releasing the previous.**

Notice that the pitch changes, but the envelopes do not start over. That is, there will be no new “attack”.

- **If polyphony is set to more voices than 1, Legato will only be applied when all the assigned voices are “used up”.**

For example, if you had a polyphony setting of “4” and you held down a 4 note chord, the next note you played would be Legato. Note, however, that this Legato voice will “steal” one of the voices in the 4 note chord, since all the assigned voices were already used up!

## Retrig

This is the “normal” setting for playing polyphonic patches. That is, when you press a key without releasing the previous, the envelopes are retriggered, like when you release all keys and then press a new one. In monophonic mode, Retrig has an additional function; if you press a key, hold it, press a new key and then release that, the first note is also retriggered.

## Portamento (Time)

Portamento is when the pitch “glides” between the notes you play, instead of instantly changing the pitch. The Portamento knob is used to set how long it takes for the pitch to glide from one pitch to the next. If you don’t want any Portamento at all, set this knob to zero.

## Setting Number of Voices - Polyphony



This determines the polyphony, i.e. the number of voices a Subtractor Patch can play simultaneously. This can be used to make a patch monophonic (=a setting of “1”), or to extend the number of voices available for a patch. The maximum number of voices you can set a Subtractor Patch to use is 99. In the (unlikely) event you should need more voices, you can always create another Subtractor!

**! Note that the Polyphony setting does not “hog” voices. For example, if you have a patch that has a polyphony setting of ten voices, but the part the patch plays only uses four voices, this won’t mean that you are “wasting” six voices. In other words, the polyphony setting is not something you need to consider much if you want to conserve CPU power - it is the number of voices actually used that counts.**

## About the Low Bandwidth button

This can be used to conserve CPU power. When activated, this function will remove some high frequency content from the sound of this particular device, but often this is not noticeable (this is especially true for bass sounds).

## External Modulation



Subtractor can receive common MIDI controller messages, and route these to various parameters. The following MIDI messages can be received:

- **Aftertouch (Channel Pressure)**
- **Expression Pedal**
- **Breath Control**

If your MIDI keyboard is capable of sending Aftertouch messages, or if you have access to an Expression Pedal or a Breath controller, you can use these to modulate parameters. The “Ext. Mod” selector switch sets which of these message-types should be received.

These messages can then be assigned to control the following parameters:

Destination	Description
F. Freq	This sets External modulation control of the Filter 1 Frequency parameter. A positive value will increase the frequency with higher external modulation values. Negative values invert this relationship.
LFO 1	This sets External modulation control of the LFO 1 Amount parameter. A positive value will increase the LFO 1 amount with higher external modulation values. Negative values invert this relationship.

Destination	Description
Amp	This lets you control the overall volume of the sound with external modulation. If a positive value is set, the volume will increase with higher external modulation values. A negative value inverts this relationship.
FM	This sets External modulation control of the FM Amount parameter. If a positive value is set, the FM amount will increase with higher external modulation values. A negative value inverts this relationship. Both oscillators must be activated for this to have any effect.

## Connections



Flipping the Subtractor around reveals a plethora of connection possibilities, most of which are CV/Gate related. Using CV/Gate is described in the chapter "Routing Audio and CV".

## Audio Output

This is Subtractor's main audio output. When you create a new Subtractor device, this is auto-routed to the first available channel on the audio mixer.

## Sequencer Control

The Sequencer Control CV and Gate inputs allow you to play the Subtractor from another CV/Gate device (typically a Matrix or a Redrum). The signal to the CV input controls the note pitch, while the signal to the Gate input delivers note on/off along with velocity.

**! For best results, you should use the Sequencer Control inputs with monophonic sounds.**

## Modulation Inputs

! **Remember that CV connections will not be stored in the Subtractor patch, even if the connections are to/from the same Subtractor device!**

These control voltage (CV) inputs (with associated voltage trim pots), can modulate various Subtractor parameters from other devices, or from the modulation outputs of the same Subtractor device. These inputs can control the following parameters:

- **Oscillator Pitch (both Osc 1 & 2).**
- **Oscillator Phase Offset (both Osc 1 & 2).**
- **FM Amount**
- **Filter 1 Cutoff**
- **Filter 1 Res**
- **Filter 2 Cutoff**
- **Amp Level**
- **Mod Wheel**

## Modulation Outputs

The Modulation outputs can be used to voltage control other devices, or other parameters in the same Subtractor device. The Modulation Outputs are:

- **Mod Envelope**
- **Filter Envelope**
- **LFO 1**

## Gate Inputs

These inputs can receive a CV signal to trigger the following envelopes. Note that connecting to these inputs will override the normal triggering of the envelopes. For example, if you connected an LFO output to the Gate Amp input, you would not trigger the amp envelope by playing notes, as this is now controlled by the LFO. In addition you would only hear the LFO triggering the envelope for the notes that you hold down. The following Gate Inputs can be selected:

- **Amp Envelope**
- **Filter Envelope**
- **Mod Envelope**

**Chapter 30**  
**Thor Polysonic**  
**Synthesizer**

# Introduction



Thor is an advanced synthesizer with many unique features.

The design could be described as semi-modular, in that the oscillator and filter sections are open slots that allow the user to select between various different oscillator and filter types, each with a distinct character. Some of these designs were inspired by selected vintage equipment.

As a result, Thor is capable of producing an astounding array of sounds.

While it offers a lot of scope for serious sound modelling, it still has a basically simple and user-friendly interface.

In the extensive Modulation bus routing section both audio and control signals (CV) co-exist, and more or less any routing combination can be assigned. Use audio to modulate a CV signal or vice versa - Thor's modulation capabilities are virtually limitless.

Thor also features an advanced step sequencer which can be used for creating melody lines or purely as a modulation source.

There are also audio inputs on the back panel. By connecting the output of another device to these inputs, you can use Thor's filters, envelopes etc. to process the sound, or you can use the external audio source to modulate a Thor parameter.

## About basic synthesizer terminology

This chapter assumes familiarity with common synth terminology like oscillators, waveforms, filters and envelopes. If you are new to Reason (or these terms), you may want to read the "[Subtractor Synthesizer](#)" chapter first, where these elements and how they interact are described from a more basic point of view.

## Loading and Saving Patches

Loading and saving patches is done in the same way as with any other Reason device - see "[Loading patches](#)" and "[Saving patches](#)".



# Thor elements

In the picture below an unfolded Thor device is shown.



Thor's user interface consists of the following elements (from the top down):

- **The Controller panel, which is always shown if Thor is unfolded.**  
See ["The Controller panel"](#).
- **The main Programmer panel contains all the synth parameters.**  
The Programmer can be shown/hidden by clicking the "Show Programmer" button on the Controller panel. See ["Using the Programmer"](#).
- **The Modulation bus routing section.**  
See ["Modulation bus routing section"](#).
- **The Step Sequencer section, where you can program up to 16 steps to produce short melody lines/grooves or use it as a modulation source.**  
See ["Step Sequencer"](#).

# The Controller panel



The Controller panel contains standard Master Volume and Pitch and Mod controls, Keyboard Mode/Note Triggering sections and four virtual (freely assignable) controls. The panel also has a patch display and standard Select/Browse/Save patch buttons (these are always shown even if Thor is folded).

## The Keyboard Mode section

In this section you make basic keyboard related settings for a patch. It has the following options:

Function	Description
Polyphony	This setting determines the number of voices that you can play simultaneously when Polyphonic mode is selected. The maximum number of voices is 32.
Release Polyphony	This governs the number of voices that are allowed to naturally decay/ring out (in the release phase of the envelope) when new notes are triggered and Polyphonic mode is selected. E.g. if you set this to "0", any new note(s) will cut off the release of any previously triggered notes.
Mono Legato	Mono Legato mode is monophonic regardless of the Polyphony setting. It works as follows: <ul style="list-style-type: none"> <li>→ <b>Hold down a key and then press another key without releasing the previous.</b> Notice that the pitch changes, but the envelopes do not start over. That is, there will be no new "attack".</li> </ul>
Mono Retrig	Mono Retrig is also monophonic and this mode means that when you press a key the envelopes are always retriggered.
Polyphonic	This is the standard polyphonic play mode - you can play the number of voices set with the Polyphony parameter.
Portamento On/Off/Auto	The knob is used for controlling portamento - a parameter that makes the pitch glide between the notes you play, rather than changing the pitch instantly as soon as you hit a key on your keyboard. By turning this knob you set how long it should take for the pitch to glide from one note to the next as you play them. There are three basic portamento modes: <ul style="list-style-type: none"> <li>• <b>In Auto mode, there will only be any portamento when playing more than one note. If any of the Mono modes is selected, portamento will only affect the legato notes.</b></li> <li>• <b>When set to On, portamento is applied to all notes.</b></li> <li>• <b>Off means no portamento.</b></li> </ul>

## Note Triggering section

Using the buttons in this section you can select in what way Thor will respond:

- **Via note input only.**
- **Via the Step Sequencer only (see "Step Sequencer").**
- **Or both.**

The section also has a standard Note On indicator.

## About the assignable controls

- The rotary knobs and buttons in the Controller panel are assignable controls that can be assigned to multiple parameters and functions in Thor.
- You assign parameters to the knobs and buttons in the Modulation Routing panel (these are located on the “Modifiers” sub-menu - see “[Modulation bus routing section](#)”).
- Movements of the assignable controls can be recorded as automation.
- Each control can be assigned to any number of parameters.
- Clicking on the label for a Rotary or Button lets you type in an appropriate name for it.

About the button key note function

To the right of the two assignable buttons there are corresponding spin controls and displays. These can be used to assign a key for turning the button on momentarily, as long as the key is held down.

- **Use the spin controls (or click in the display and move the mouse up or down) to assign a key for the button status.**

The assigned key will now turn the function(s) assigned to the button on for as long the key is held down.

- **Note that the key note function can only switch from off to on, not the other way around, so make sure the button is deactivated if you wish to use this function.**

An assigned key will not trigger a note, only the button status. Also note that the button will not light up when you press the assigned key.

## The Pitch Bend and Modulation wheels

- The Pitch and Mod wheels on the Controller panel will mirror the corresponding actions on your master keyboard.
- The Range parameter (like for all instrument devices) sets the range of the Pitch Bend action.
- Pitch Bend is pre-wired to the pitch parameter of the three oscillators, but you can of course use it to control any parameter you like. If you don't want Pitch Bend to affect oscillator pitch, simply set the Range parameter to “0”.

## Master volume

This is the main volume control for outputs 1 & 2.

# Using the Programmer

The Programmer contains the main synth parameters.

- To show the **Programmer** panel, click the **“Show Programmer”** button on the **Controller** panel. The Programmer appears below the Controller panel.



- The **Programmer** panel is divided into two sections; the **Voice** section to the left and the **Global** section to the right. The **Global** section has a separate brown panel to differentiate it from the **Voice** section. The **Voice** section contains the basic synth parameters and the parameters are “per-voice”, i.e. all envelope and LFO cycles are triggered individually for each voice. The **Global** section to the right contains global parameters that affect all voices.
- There are three open **Oscillator** slots, a **Mixer**, two open **Filter** slots, a **Shaper**, three **Envelope** generators, an **LFO** and an **Amplifier** in the **Voice** section. The open **Oscillator** and **Filter** slots allow you to select between different types of oscillators and filters.
- The **Global** section contains a second **LFO**, a **Global Envelope**, a third open **Filter** slot and **Chorus** and **Delay** effects.

## Basic connections - a tutorial

There are certain pre-defined connections available between the Oscillator 1-3 slots and the Mixer, Filter 1/Shaper, Filter 2 and Amp sections. On the panel itself, lines with arrows are shown to indicate the standard signal paths.

- **Note that you can also connect sections using the Modulation bus section (see “[Modulation bus routing section](#)”). You are not in any way limited to the pre-defined routings, but they do provide a quick and convenient way to connect the basic synth “building blocks” together.**

In the following tutorial we will create a standard setup using two oscillators and two filters to demonstrate Thor basics and the (standard) signal path:

### 1. Select “Reset Device” from the context menu or from the Edit menu.

The “Init patch” is a basic setup with an Analog oscillator in Oscillator slot 1 and a Ladder LP filter in Filter slot 1 loaded. A connection between Oscillator 1, Filter 1 and the Amp section is already activated, so you get a sound when you play.

Below the Oscillator 1 slot in the upper left corner are two more slots, currently empty. These are the Oscillator 2 and 3 slots, respectively. The three Oscillator slots are basically identical in that they can each be loaded with one of 6 oscillator types.

### 2. Click the arrow pop-up in the upper left corner of the Oscillator 2 slot, and select a second oscillator from the pop-up that appears.

The following oscillator types are available; Analog, Wavetable, Phase Modulation, FM Pair, Multi and Noise. For a description of the various oscillator types, see “[The Oscillator section](#)”.



*Selecting oscillator type.*

With a basic connection setup, the Oscillator outputs are internally connected to the “Mix” section. To pass the output signal onwards in the signal chain, you first have to activate a connection. This is done using the two vertical rows of routing buttons labelled 1, 2 and 3 to the right of the Oscillator section.



- **The upper row of routing buttons determine which of the Oscillators 1 to 3 are routed to Filter 1, and the lower row which of the Oscillators 1 to 3 are routed to Filter 2.**

All three oscillators can be simultaneously routed to both filters, serially or in parallel (or any combination of these variations). This is explained later in this tutorial.

By activating one or more of these buttons means that the oscillator (1 to 3) is routed to the corresponding Filter. Currently, Oscillator 1 is connected to Filter 1 slot (which is pre-loaded with a Ladder LP filter).

This is indicated by the “1” routing button being lit. The Filter 2 slot is currently not active, which is indicated by a blank panel.

3. **Click the “2” button to the left of the Filter 1 section so that it lights up to activate a connection for Oscillator 2.**

Now if you play a few notes you should hear both Oscillator 1 and Oscillator 2, via the Filter 1 section.



- **The Filter 1 output passes via the Shaper (currently not activated), on to the Amp section, and finally to the Main Outputs.**

Actually, the Amp section output is routed via the Global section before being sent to the Main Outputs, but as currently nothing is activated in the Global section the signal passes through unprocessed.

**4. Next, click the arrow pop-up in the upper left corner of the Filter 2 slot.**

A pop-up menu with the four available Filter types appears. For a description of the filter types, see [“Filter slots”](#).



**5. Select a type of filter, e.g. a Comb filter for the Filter 2 slot.**

Now that the Filter 2 slot in the Voice section is active, you can connect the oscillators to it by using the lower row of routing buttons.

**6. Click the routing buttons “1” and “2” to the left of the Filter 2 slot so that the buttons are lit.**

Now the two oscillators are connected to Filter 2.

**7. Make sure the arrow routing button that points to the Amp section just above the Filter 2 section is activated.**

Now if you play a few notes, both oscillators are routed via both filter sections in parallel. You could of course select to pass only one of the oscillators via one filter and both oscillators via the other - any combination is possible.



You can also connect the Filter 1 and 2 sections serially, meaning that the output of Filter 1 is passed through Filter 2 before reaching the Amp section. This is done as follows:

**8. Switch off the routing buttons “1” and “2” to the left of the Filter 2 slot.**

If you leave them on the oscillators will pass through Filter 2 twice; both via Filter 1 and directly. This is also perfectly “allowable”, but to make things clearer in this tutorial we will use a standard serial filter setup.

**9. Click the Arrow “left” button below the Shaper.**

Now the filters are connected serially, with the output of Filter 1 (via the for now inactive Shaper) being connected to the Filter 2 input. Both oscillators are processed by both filters connected in series.



That concludes this tutorial on how the pre-wired connections in the Voice section can be used, but note that you can also use the Modulation bus to make connections - see [“Modulation bus routing section”](#).

## Other pre-defined routing assignments

There are other sections in Thor which are pre-defined and can be used without having to make any prior assignments:

- **The Amp Envelope and the Filter Envelope control the volume level and frequency of the Filters (1 & 2), respectively.**

The amount of filter envelope control is controllable by using the “Env” parameter in each Filter section.

- **The effects (Delay/Chorus) in the Global section are part of the signal chain and can simply be switched on and used.**

## The Oscillator section



Oscillators generate the basic raw sound (pitch and waveform) that can in turn be processed by the other parameters. The Oscillator section contains three open slots which can each be loaded with one of six oscillator types. The three Oscillator slots are numbered 1-3, with the top slot housing Oscillator 1, the middle slot Oscillator 2 and the bottom slot Oscillator 3.

- **The Arrow button in the top left corner of each slot opens a pop-up menu where an oscillator type can be selected for the corresponding slot.**

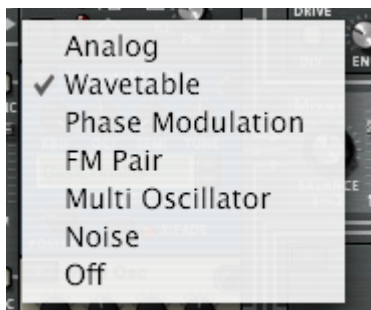

There are six Oscillator types available:

- **Analog**
- **Wavetable**



- **Phase Modulation**
- **FM Pair**
- **Multi Oscillator**
- **Noise**

You can also select Off mode (no oscillator).

## Common parameters

The specific parameters of the various oscillator types are described separately, but there are also common parameters that apply to all oscillator types. These are:

- **Octave (OCT) knob - this changes the pitch of the oscillator in octave steps.**  
The range is ten octaves.
- **The Semi knob changes the pitch of the oscillator in semi-tone steps.**  
The range is 12 semitone steps (1 octave).
- **The Tune knob fine tunes the pitch of the oscillator in cent steps.**  
The range is +/- 50 cents (down or up half a semitone).
- **Keyboard Track (KBD) - this knob sets how much the oscillator pitch tracks incoming note data.**  
Turned fully clockwise the pitch tracks the keyboard normally, i.e. a semitone per key.
- **All oscillators also have waveform selectors and a modifier parameter. How the waveform selection works, and what parameter is the modifier varies according to the selected oscillator type.**
- **Important to note is that if you have made a modulation routing to an oscillator parameter e.g. the modifier, and then change the oscillator type, the modulation will be transferred to the corresponding parameter in the new oscillator.**  
The same goes for all common parameters (tuning and tracking). If you switch oscillator type, all common parameters are left unchanged.
- **Oscillators can be synced - see “About Oscillator Sync”.**
- **Any oscillator type loaded into the Oscillator 1 slot can also be amplitude modulated by Oscillator 2 - see “About Amplitude Modulation (AM)”.**

## Analog oscillator



This is a classic analog oscillator with 4 standard waveforms. The waveform selector button is in the lower left corner of the oscillator panel, but you can also click directly on the waveform symbols to switch waveform. The four available waveforms are from the top down (as displayed on the panel): Sawtooth, Pulse, Triangle and Sine.

- **The Mod parameter (PW) controls pulse width and only affects the pulse waveform.**  
By modulating the PW parameter the width of the pulse wave changes, allowing for PWM (Pulse Width Modulation) which is a standard feature in most vintage analog synths.
- **For a perfect square wave, set pulse width (PW) to 64.**

## Wavetable oscillator



Wavetable oscillators has been the basis of several vintage synths (PPG, Korg Wavestation and many others).

- **With the Wavetable oscillator, you select between 32 wavetables, where each wavetable contains several (up to 64) different waveforms. By using an envelope or a LFO you can sweep through a wavetable to produce timbre variations.**

The parameters are as follows:

- **Position is the modifier (Mod) parameter and controls the position within the selected wavetable, i.e. which waveform is active at a given time.**  
By modulating the Position you can sweep through the waveforms in the selected wavetable. You can of course also use a single static waveform in a wavetable if you so wish, by not applying any modulation to this parameter.
- **The X-Fade button determines whether the change between waveforms in a wavetable should be abrupt (X-Fade off), or smooth (X-Fade on).**  
If set to on, the waveform transitions are cross-faded.
- **There are 32 wavetables that can be selected using the up/down buttons or by clicking in the Wavetable display.**

Some of the wavetables have waveforms that sequentially follow the harmonic series, i.e. each following waveform adds a harmonic. Others have waveform series that produce a sound similar to oscillator sync when swept, and other wavetables are simply mixed waveforms. The last 11 wavetables are based on wavetables used in the original PPG 2.3 synthesizer.

## Phase Modulation oscillator



The Phase Modulation oscillator is inspired by the Casio CZ series of synthesizers. Phase modulation is based on modulating the phase of digital waveforms to emulate common filter characteristics.

- **You have a First and Second waveform which can be combined. Instead of mixing the two waveforms they are played in series, one after the other.**  
This adds a fundamental one octave below the pitch of the original sound.
- **The PD parameter (Mod) changes the shape of the wave, much like a filter does.**

The following waveforms (sequentially from the first) are available as the First waveform:

- **Sawtooth**
- **Square**

- **Pulse**
- **Pulse and Sine**
- **Sine and flat (half sine)**
- **Saw x Sine**
- **Sine x Sine**
- **Sine x Pulse**

The last three waveforms could be described “resonant”, as these originally were meant to simulate filter resonance. They didn't really do this very accurately, but nevertheless constituted an important part of the sound.

The Second waveform has the same available waveforms except the last three, and it can also be bypassed altogether. You can combine waveforms freely, except it is not possible to combine two “resonant” waveforms.

## FM Pair oscillator



As the name implies, this oscillator generates FM, where one oscillator (Carrier) is frequency modulated by a second oscillator (Modulator). Although very simple to use (unlike most hardware FM synths), this oscillator can produce a very wide range of FM sounds.

→ **The Carrier and Modulator selector buttons set the frequency ratio between these two oscillators (the range is 1-32).**

The frequency ratio is what determines the basic frequency content, and thus, the timbre of the sound.

→ **The FM knob sets the amount of frequency modulation.**

This is also the Modifier parameter. If FM amount is set to zero, there is no FM and the output will be a pure sine wave.

• **If you set FM Amount to zero and step through the values of the Carrier oscillator, you can hear that the pitch is changed according to the harmonic series.**

• **Stepping through the Mod oscillator values will change the pitch in the same way, although FM Amount has to be set to a value other than zero to be able to hear it.**

Thus, 2:2 is the same wave shape as 1:1 but one octave higher in pitch, 3:3 is the same wave shape as 2:2 but a fifth higher in pitch and so on.

## Multi oscillator



This versatile oscillator can simultaneously generate multiple detuned waveforms (of a set type) per voice. It is great for producing complex timbres e.g. to simulate cymbal or bell sounds, but can also generate a wide range of harmonic sounds.

→ **The following basic waveforms are available: Sawtooth, Square, Soft Sawtooth, Soft Square, Pulse.**

You switch waveforms using the button in the lower left corner, or by clicking directly on the waveform symbol.

→ **The Amount (AMT) parameter governs the amount of detune.**

Turn clockwise for more detune. This is also the modifier (Mod) parameter. Using low Amount settings can produce subtle detune variations that makes the sound shift and move endlessly, like an advanced chorus effect, whereas higher Amount settings can produce wild, detuned timbres.

→ **The Detune Mode parameter sets the basic operational mode of the detuning.**

If Amount is set to 0, only the "Octave" and "Fifth" Detune modes actually change the sound, as these modes start off with dual waveforms tuned one octave and a fifth apart, respectively. The "Fifth Up" and "Oct UpDn" modes detune waveforms as the names imply between zero to full Amount settings. "Linear" will change the amount of detune according to where on the keyboard you play; in lower keyboard ranges the amount of detune is stronger than in higher keyboard ranges and vice versa. The other modes (Interval and Random) basically add multiple waveforms and detune them in various ways that will produce different results.

## Noise oscillator



The Noise oscillator can not only produce white and colored noise, but can also be used either as a pitched oscillator or as a modulation source.

It has the following basic parameters:

→ **There is a single Noise parameter (apart from the standard tuning and kbd track knobs).**

This is the Noise modifier parameter, that controls different parameters depending on the selected Oscillator mode, see below.

→ The **Waveform selector button in the bottom left corner is used to set the Oscillator mode.**

The following modes are available:<sup>1</sup>

Mode	Description
Band	In this mode, the Oscillator knob controls bandwidth. Turned fully clockwise, the oscillator produces pure noise. Turning the knob counter-clockwise gradually narrows the bandwidth until a pitch is produced. The pitch will track the keyboard normally if the keyboard (KBD) knob is set fully clockwise.
S/H	S/H stands for "sample and hold", which is a type of random generator. The Oscillator knob controls the rate of the sample and hold. With high Oscillator knob settings, it produces colored noise with a slightly "phased" sound quality. With lower rate settings you can use the oscillator as a modulation source like a LFO with random values. For example, if you modulate the pitch of another oscillator using S/H with a low Rate setting as the source, you will get stepped random modulation of the pitch.
Static	As the name implies, this can generate the sound of static interference if you use low Oscillator settings. The Oscillator parameter controls Density, i.e. the amount of static. High Density settings generates noise.
Color	This produces colored noise, which is basically noise where certain frequency areas are filtered, i.e. cutting or boosting certain frequency areas in the noise. The Oscillator knob controls Color. With a maximum Color setting you get white noise, and lower settings produces noise emphasizing lower frequencies.
White	This produces pure white noise, where all frequencies have equal energy. There is no associated Oscillator parameter for White noise.

## About Oscillator Sync

Oscillator sync is when one oscillator will restart the period of another oscillator, so that they will have the same base frequency. If you change or modulate the frequency of the synced oscillator you get the characteristic sound associated with oscillator sync.

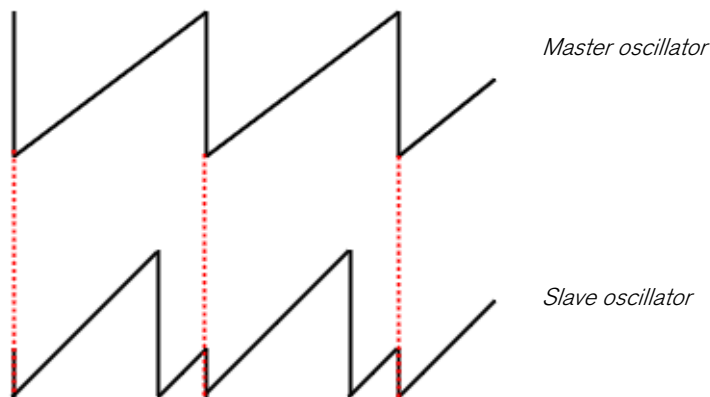

A synced oscillator that resets the other oscillator(s) is called the master, and any synced oscillator that is reset by an other oscillator is called a slave. In Thor, oscillator 1 is the master, i.e. this controls the base pitch of the oscillators, and oscillators 2 and 3 are slaves.

- **Switch Oscillator Sync on or off by activating the Sync buttons to the left of Oscillator slots 2 and 3.**



- **The Sync “BW” sliders to the left of Oscillator slots 2 and 3 allows you to adjust the sync bandwidth.**  
This allows you to change the character of the oscillator sync. The parameter basically sets how abrupt the reset is - high bandwidth settings produces a more pronounced sync effect and vice versa. The picture above illustrates high bandwidth reset - if lower bandwidth settings are used the slave osc curve will be more rounded at the reset points.

## About Amplitude Modulation (AM)

AM (Amplitude Modulation) is often referred to as ring modulation. AM works by multiplying two signals together.

- **In Thor, Oscillator 2 amplitude modulates Oscillator 1.**  
The Ring Modulated output will then contain added frequencies which are generated by the sum of, and the difference between the two signals. This can be used for creating complex, enharmonic sounds.
- **The amount of AM is set using the slider to the left of the Oscillator 1 slot.**



## Mix section



The Mix section allows you to adjust the levels and the relative balance of the three oscillators.

- **The two sliders controls the output levels of oscillators 1-2 and oscillator 3, respectively.**
- **The Balance knob sets the balance between oscillator 1 and 2.**

The Balance parameter is also a modulation destination, allowing you to modulate the balance of the two oscillators with e.g. an LFO. Note that the oscillators have to be connected to the filter(s) via the numbered routing buttons for the Mix section settings to have effect.

## Filter slots



Thor has three open Filter slots, two in the Voice section (which act per-voice) and one in the Global section which is global for all voices (see [“Global Filter slot”](#)).

- **You select (or change) filter type for a slot by clicking the arrow button in the top left corner of a slot.** On the pop-up you can select between 4 filter types and bypass mode. Available filter types are Ladder LP, State Variable, Comb and Formant, each described separately below.

The following general rules apply:

- **Filters are pre-wired to the Filter Envelope (see [“Filter Envelope”](#)).**

- **Filters 1 & 2 can be used serially (i.e. the output of Filter 1 goes (via the Shaper) to the input of Filter 2, or in parallel (meaning that one signal goes to Filter 1 and another to Filter 2).**

The pre-defined routings of the three oscillators into the Filter 1-2 sections is described in the [“Basic connections - a tutorial”](#) passage.

## Common parameters

As with the open oscillator slots, there are certain parameters which are common for all filter types.

These are as follows:

- **All the filter types have large knobs for the filter frequency (FREQ) parameter and the filter resonance (RES) parameter.**  
This works slightly differently for the Formant filter - see [“Formant filter”](#).
- **The “KBD” parameter sets how the filter frequency tracks incoming note pitch data.**  
Some filter types (Ladder/State Variable/Comb) can “self oscillate” and be used as extra oscillator sources.
- **The “ENV” parameter sets how much the filter frequency responds to the Filter Envelope.**
- **The “VEL” parameter sets how much incoming note velocity affects the Filter Envelope Amount.**  
In other words, for this parameter to have any effect it requires that the “ENV” parameter is set to a value other than zero.
- **The “INV” button inverts how the filter frequency responds to Envelope settings.**
- **The “Drive” parameter allows you to adjust the input gain to the filter.**  
By driving the filter harder you can add further character to the sound.
- **Any parameter settings, as well as any modulation assigned to parameters, will be kept even if you change the filter type.**

## Ladder LP Filter



The Ladder LP filter is a low-pass filter inspired by the famous voltage controlled filter patented by Dr. Robert Moog in 1965. The name originates from the ladder-like shape of the original transistor/capacitor circuit diagram.

The original filter also had certain non-linear characteristics which contributed to the warm, musical sound it is renowned for. These characteristics are faithfully reproduced in the Ladder LP filter.

There is also a built-in shaper in the feedback (self-oscillation) loop. If self-oscillation is activated (see below), the shaper will distort the sound to produce these non-linear characteristics. To adjust the intensity of this distortion you use the Drive parameter.

- **There are 4 different Filter slopes available; 24, 18, 12 and 6 dB/oct.**  
24dB slope comes in two different types:
  - **Type I - The shaper (controlled with the Drive parameter) is placed at the filter output but before the feedback loop.**
  - **Type II - The shaper (controlled with the Drive parameter) is placed at the filter input after the feedback loop.**



Note that “Self Osc” (see below) must be activated for the shaper to operate.

→ **This filter can self-oscillate and will produce a playable note pitch with high Resonance settings if this is activated.**

Self-oscillation can be switched on or off by using the “SELF OSC” button. The “KBD” knob governs how the frequency tracks the keyboard, turned fully clockwise will produce 12 semitones/octave tracking.

## State Variable Filter



This is a multi-mode filter which offers 12 dB/octave slope Lowpass (LP), Bandpass (BP), Highpass (HP), plus Notch and Peak filter modes which are sweepable between HP/LP states, similar to the vintage Oberheim SEM filter.

The filter modes are as follows:

→ **LP 12 (12 dB lowpass)**

Lowpass filters let low frequencies through and cut off high frequencies. This filter type has a 12dB/Octave slope.

→ **BP 12 (12 dB bandpass)**

Bandpass filters cut both high and low frequencies, leaving the frequency band in between unaffected. Each slope in this filter type is 12 dB/Octave.

→ **HP 12 (12 dB highpass)**

Highpass filters let high frequencies pass and cut off low frequencies. This filter type has a 12dB/Octave slope.

→ **The “Notch” and “Peak” filter modes employ a combination of two outputs from the same filter combining LP and HP set to the same the filter frequency.**

The “LP/HP” knob associated to these two filter modes can modulate the state of the filter from low-pass to high-pass. If the knob is in the mid-position, you get a Peak or Notch filter slope (depending on the mode). The HP/LP parameter can be assigned as a modulation destination.

→ **This filter can self-oscillate and will produce a pitch with high Resonance settings if this is activated.**

Self-oscillation can be switched on or off by using the “SELF OSC” button. The “KBD” knob governs how the frequency tracks the keyboard, turned fully clockwise will produce 12 semitones/octave tracking.

## Comb filter



The Comb filter can add subtle pitch variations and phasing-like effects to sounds.

- **Comb filters are basically very short delays with adjustable feedback (controlled with the Resonance knob).**  
A comb filter causes resonating peaks at certain frequencies. Comb filters are used in various signal processing devices like flangers, and produces a characteristic swooshing sound when the frequency is swept.
- **The difference between the “Comb +” and “Comb -” modes is the position of the peaks in the spectrum.**  
The main audible difference is that negative Comb mode causes a bass cut.
- **The Resonance parameter in both cases controls the shape and size of the peaks.**  
This filter will produce a pitch with high Resonance settings combined with low frequency settings.

## Formant filter



The Formant filter type can produce vowel sounds. There are no Frequency or Resonance parameters, instead you have a horizontal “X” parameter slider and a vertical “Y” parameter slider that operate together to produce the various filter formant characteristics.

- **You can alter the settings of both the “X” and “Y” parameters simultaneously by moving the “dot” inside the gray rectangle on the filter panel.**  
Horizontal movement changes the “X” parameter, and vertical movement the “Y” parameter.



- **The ENV-VEL-KBD knobs affect the “X” parameter.**  
The parameter can be CV controlled.
- **The “Gender” parameter changes the basic timbre of the vowel generation between male (low Gender settings) and female (high Gender settings) voice characteristics.**  
Gender can also be CV controlled.

## Shaper

Waveshaping is a synthesis method for transforming sounds by altering the waveform shape, thereby introducing various types of distortion. The Shaper can radically transform the sound or just add a little warmth, depending on the mode and other settings.

- **The Shaper input is taken from the Filter 1 output.**
- **The Shaper is activated with the button in the top left corner of the section.**



- **The Drive parameter sets the amount of waveshaping.**  
Tip: By raising the Filter 1 Drive parameter you can add even more grit and distortion to the Shaper output.
- **The Shaper has 9 modes, selectable with the spin controls or by clicking in the Mode display, all which distort the waveform in various different ways.**  
These modes are; Soft and Hard clip, Saturate, Sine, Bipulse, Unipulse, Peak, Rectify and Wrap. Exactly how the various modes affect the sound depends on many factors, and there is a slightly random element to the resulting distortion. We recommend simply trying the different modes to hear what happens - many interesting types of distortion of the original signal are guaranteed!

## Amp section



The Amp (amplifier) section has two inputs (from Filter 1 & 2) and one output that is routed to the Global section (and on to the Master Level and the Main Outputs).

- **The Gain knob controls the level and the Velocity knob controls the Gain modulation, i.e. how much velocity affects the level - positive values means that you get higher level the faster you strike a key.**
- **The Pan knob controls the relative stereo position of the individual voices.**  
By applying modulation to this parameter, you can make individual voices appear in different stereo positions when you play.

# LFO 1



An LFO (Low Frequency Oscillator) is used for generating cyclic modulation. A typical example is to have an LFO modulate the pitch of an oscillator to produce vibrato, but there are countless other applications for LFOs.

→ **LFO 1 will apply modulation polyphonically.**

i.e. if LFO 1 modulation of a parameter is assigned, an individual LFO cycle will be triggered for each note you play.

→ **You select a LFO waveform by using the spin controls beside the waveform display, or by clicking in the display and moving the mouse up or down.**

The following parameters are available for LFO 1:

Parameter	Description
Rate	This sets the frequency or rate of the LFO.
Waveform	This sets the LFO waveform. Apart from standard waveforms (sine, square etc.) there are various different random, non-linear and stepped waveforms. The shape of the waveforms are shown in the display, and these shapes basically reflect how a signal is affected.
Delay	This introduces a delay before the LFO modulation onset after a note is played. Turn clockwise for longer delay.
KBD Follow	This determines if (or how much) the Rate parameter is affected by note pitch. If you turn the knob clockwise, the modulation rate will increase the higher up on the keyboard you play.
Key Sync	As explained previously, LFO 1 is polyphonic and will produce a separate LFO cycle for each note played. If Key Sync is off, the cycles are free running, meaning that when you play a note the modulation may start anywhere in the LFO waveform cycle. If Key Sync is on, the LFO cycles are reset for each note played.
Tempo Sync	If this is on, the Rate will be synced to the sequencer tempo.

# Envelope sections



There are three Envelope generators in the Voice section. These are the Amp envelope, the Filter envelope and the Mod envelope. Each voice played has a separate envelope. There is also an additional Global Envelope which is described separately - see [“Global Envelope”](#).

→ **The Filter envelope is pre-wired to control the frequency of Filter 1 and 2.**

Note that envelope control of filter frequency can be switched off in each Filter section (the Env parameter can be set to 0), so the Filter Envelope can be used to control other parameters as well.

→ **The Amp Envelope is pre-wired to control the amplitude (volume).**

Similarly, the Amp envelope can also be used to control other parameters, but in the Voice section you cannot switch off or bypass the Amp Envelope - if no voice is active (i.e. if there is no gate trigger input to the Amp envelope) there will be no output from oscillators or any external audio source routed to the Voice section.

→ **The Mod Envelope can be freely assigned to control parameters.**

This is done in the Modulation section.

## Filter Envelope

The Filter Envelope is a standard ADSR envelope as used in the Subtractor.

→ **By setting up a filter envelope you control the how the filter frequency or some other parameter should change over time with the four parameters, Attack, Decay, Sustain and Release.**

Please refer to the Subtractor chapter for a description of these parameters.

→ **The “Gate Trig” button can be used to switch off the envelope triggering from notes (which is the normal mode) and allow the envelope to be triggered by some other parameter.**

“Gate Trig” should normally be activated.

→ **The time ranges of each step are as follows:**

Attack: 0 ms - 10,3 s / Decay and Release: 3 ms - 29,6 s. Sustain is not set as a time but as a level (from Off to 0dB).

## Amp Envelope

The Amp Envelope is also a standard ADSR envelope.

→ **By setting up a Amp envelope you control the how the amplitude or some other parameter should change over time with the four parameters, Attack, Decay, Sustain and Release.**

Please refer to the Subtractor chapter for a description of these parameters.

→ **The “Gate Trig” button can be used to switch off the envelope triggering from note input (which is the normal mode) and allow the envelope to be triggered by some other parameter.**

“Gate Trig” should normally be activated.

→ **The ranges of each step are the same as for the Filter envelope.**

## Mod Envelope

This is a general purpose ADR (Attack, Decay, Release) envelope with a pre-delay stage before the Attack phase. The Delay to Decay phase can also be looped. Apart from standard Attack, Decay and Release stages the Mod Env has the following parameters:

Parameter	Description
Delay	This can set a delay before the onset of the envelope.
Loop	If this is activated, the envelope phase from Delay to Decay will continuously loop.
Tempo Sync	If this is on, each stage will have a length that corresponds to beat increments of the current sequencer tempo. E.g. you can have a 1/4 delay before a 1/16 attack phase followed by a 1/8 decay. Each stage can be set a range from 1/32 to 4/1 (4 bars). If this is off, the envelope times are free running and can be set in seconds (same time ranges as for the Filter Envelope).
Gate Trigger	The “Gate Trig” button can be used to switch off the envelope triggering from notes (which is the normal mode) and allow the envelope to be triggered by some other parameter. “Gate Trig” should normally be activated.

## Global section



The Global section contains parameters that affect all voices. It contains two effects, an open filter slot, the Global Envelope and LFO 2.

## Effects section

There are two global mono in/stereo out effects, a Delay and a Chorus. These effects affect all voices coming from the Amp section equally if activated. The effects are placed after the Global Filter in the signal chain.

→ **There are controls for standard Delay/Time and Feedback parameters.**

Chorus vs. Delay differ only in the delay time range - Chorus is for chorus effects, i.e. short delays, whereas Delay produces echo effects.

→ **Delay Time can be Tempo Synced.**

This is set with the Tempo Sync button - if on the delay time is set in beat resolutions synced to the main sequencer tempo.

→ **The Delay and Chorus effects can also be pitch modulated by a built in LFO (the “Mod” parameters).**

“Rate” controls LFO speed and “Amount” the Stereo width.

→ **Dry/Wet governs the balance between the unprocessed (dry) signal and the effect (wet) signal.**

## Global Filter slot

This is the Filter 3 slot which can be loaded with one of the filter types. Filter 3 is basically set up as the other filter slots. The difference is that all voices are mixed together before entering the filter. The “ENV” parameter governs modulation by the Global Envelope. If you play one note the filter envelope will trigger. Adding new notes while a note is still held down (legato) will not trigger the filter envelope.

See “[Filter slots](#)” for a description of the filter types.

## Global Envelope

The Global Envelope 4 is an advanced envelope that is free to use for whatever purpose, but remember it is “single trigger” so it will not retrigger legato notes as explained above. It is an ADSR envelope with a pre-delay stage and a hold stage before the decay phase. You can make it Loop and Sync the time settings to the song tempo.

Apart from standard ADSR parameters, the Global Envelope has the following parameters:

Parameter	Description
Delay	This can set a delay before the onset of the envelope.
Loop	If this is activated, the envelope phase from Delay to Decay will continuously loop.
Hold	This allows you to set a “hold” phase before the Decay.
Tempo Sync	If this is on, each stage will have a length that corresponds to beat increments of the current sequencer tempo. E.g. you can have a 1/4 delay before a 1/16 attack phase followed by a 1/8 decay. Each stage can be set a range from 1/32 to 4/1 (4 bars). If this is off, the envelope times are free running and can be set in seconds (same time ranges as for the Filter Envelope).
Gate Trigger	The “Gate Trig” button can be used to switch off the envelope triggering from notes and allow the envelope to be triggered by some other parameter. This button is normally activated.

## LFO 2

- The LFO 2 is a standard LFO but is not polyphonic like LFO 1. It is not assigned to any parameter in an “Init” patch so you have to use the Modulation Routing section to use it.
- Also the LFO 2 “Delay” and “Key Sync” parameters are single trigger, i.e. the LFO will not retrigger these parameters for legato notes.
- You select a LFO waveform by using the spin controls beside the waveform display, or by clicking in the display and moving the mouse up or down.

The following parameters are available for LFO 2:

Parameter	Description
Rate	This sets the frequency or rate of the LFO.
Waveform	This sets the LFO waveform. Apart from standard waveforms (sine, square etc.) there are various different random, non-linear and stepped waveforms. The basic shape of the waveforms are shown in the display, and illustrate how a signal is affected.
Delay	This introduces a delay before the LFO modulation onset after a note is played. Turn clockwise for longer delay.
Key Sync	If Key Sync is off, the LFO cycle is free running, meaning that when you play a note the modulation may start anywhere in the LFO waveform cycle. If Key Sync is on, the LFO cycle is reset for each note played.
Tempo Sync	If this is on, the Rate will be synced to the sequencer tempo in beat increments (4/1 to 1/32).

## Modulation bus routing section



A modulation bus is used to connect a modulation source to a modulation destination. Both audio signals and control (CV) parameters are available. This creates a flexible routing system that complements the pre-wired routing in the Voice panel.

### Basic operation - simple tutorial

To illustrate the basic operation of the modulation bus section, let's set up a simple source to destination modulation assignment:

**! If you currently have unsaved settings you wish too keep, don't forget to save them first.**

#### 1. Select “Reset Device” from the Edit menu.

The Init patch is a simple 1 oscillator/1 filter setup, which produces sound when you play, and will serve the purpose of this tutorial.

- **The left half of the modulation section contains 5 columns, Source, Amount, Dest, Amount and Scale.**  
Below the column headers there are 7 rows. Each row is a modulation bus where you can have a Source to Destination modulation assigned.

#### 2. Click in the top row of the leftmost Source column.

A pop-up menu appears listing all available Source modulation parameters.



The upper half of the menu contains Voice section source parameters, and the lower half contains various global play and performance-oriented source parameters and the Global Envelope, as well as the Step Sequencer, CV and Audio inputs.

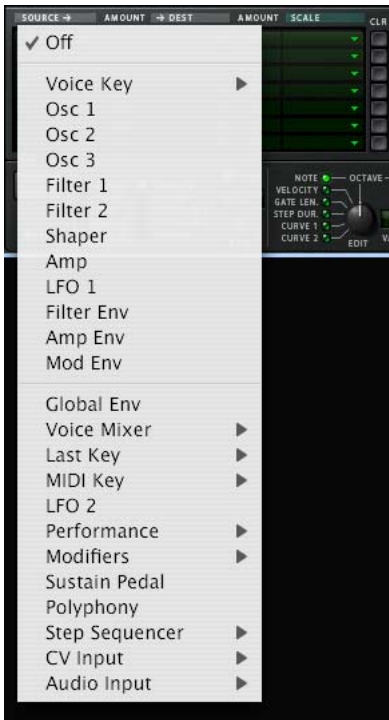

**3. Select “LFO 1” from the pop-up.**

This means that LFO 1 is the modulation Source, and this can now be assigned to modulate a Destination parameter.

**4. Pull down the “Dest” column pop-up in the top row.**

A pop-up menu appears listing all available modulation Destinations. The upper half of the menu contains Voice section destinations, and the lower half contains Global section destinations, as well as the Step Sequencer, CV and Audio outputs.

**5. Select “Osc 1” from the menu and then “Pitch” from the submenu.**

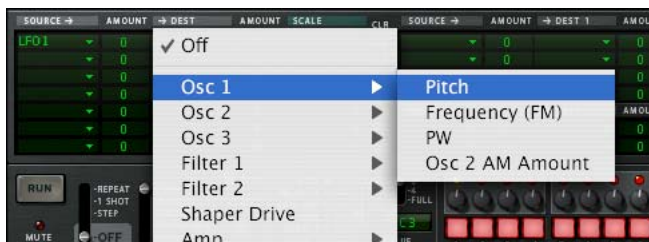

This means that Osc 1 pitch is now assigned to be modulated by LFO 1. Next step is to set the amount of modulation to be applied.

**6. Click in the top row Amount column to the right of the Source column, and move the mouse pointer up and down to set an Amount value.**

Both positive and negative Amount values can be set (+/- 100%).

**→ If you now play a few notes you can hear the oscillator pitch being modulated by the LFO to produce vibrato.**

But the vibrato will be constant, which you probably don't want. This is solved by assigning a Scale parameter, which allows you to assign another parameter to control the modulation Amount.

### 7. Pull down the “Scale” column pop-up in the top row.

A pop-up menu appears listing all available Scale parameters. The upper half of the menu contains Voice section parameters, and the lower half contains various play and performance-oriented parameters and the Global Envelope, as well as the Step Sequencer, CV and Audio inputs.

A typical controller for vibrato is the Mod wheel.

### 8. Select “Performance” from the menu and then “Mod wheel” from the submenu.

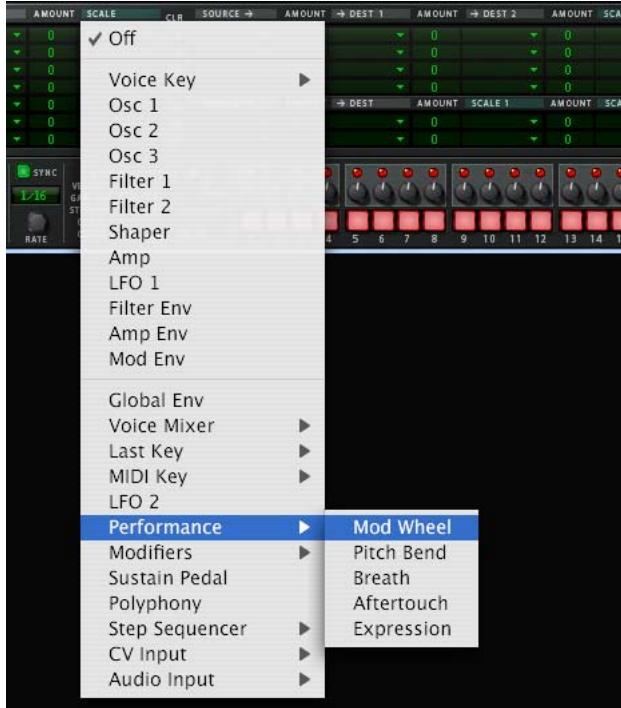

This means that Osc 1 pitch is now assigned to be modulated by LFO 1, and the amount of modulation is controlled by the Mod wheel. How much the Scale parameter controls the Amount is set using the “Amount” column for the top row (to the left of the Scale column).

### 9. Click in the top row Amount column and move the mouse pointer up and down to set an Amount value.

Both positive and negative Scale Amount values can be set (+/- 100%). To fully control the LFO modulation so that there is no vibrato when the Mod wheel is set to zero, set the Amount to 100%.



### 10. The modulation routing is now complete!

You now have full control over the vibrato modulation by using the Mod wheel.

- **How much modulation will be applied when the Scale parameter is set to maximum is governed by the Source to Destination Amount parameter.**
- **How much the Scale parameter controls the modulation is set with the Scale Amount parameter.**
- **To clear any assigned modulation routing you can use the “CLR” button to the right of the corresponding bus.**

## About the three modulation routing types

As described in the tutorial, the principal operators of the Modulation bus routing system are as follows:

- **You have Modulation Source, Modulation Destination and Modulation Amount parameters.**
- **Optionally, you have a Scale parameter controlling the Modulation Amount, and a Scale Amount that governs how much the Scale parameter controls the Modulation Amount.**

There are three different types of modulation routing busses available in Thor:

- **You have seven “Source -> Destination -> Scale” routing busses.**

These are the seven rows in the left half of the Modulation section, as covered in the tutorial.



- **There are four “Source -> Destination 1 -> Destination 2 -> Scale” busses.**

These are the four top rows in the right half of the Modulation section. This works after the same principle but the Source parameter can affect two different Destination parameters (with variable Amount settings) and a Scale parameter that affects the relative modulation Amount for both Destinations.

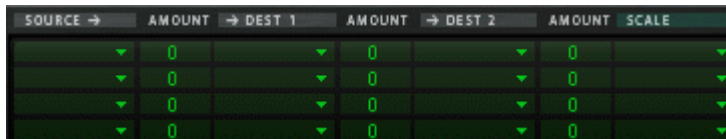

- **Lastly, there are two “Source -> Destination -> Scale 1 -> Scale 2” busses.**

This means that a modulation Amount can use two Scale parameters.

An example: You have the Mod Envelope as Source and Oscillator Pitch as the Destination (Amount set whatever you like). As the first Scale parameter we use the Mod Wheel (Amount set to 100 so that no modulation is applied when the Mod wheel is at zero), and LFO 1 as the second Scale parameter (Amount set to whatever you like). When you move the Mod wheel, the pitch modulation amount will be modulated by both the Mod Envelope and LFO 1 simultaneously.

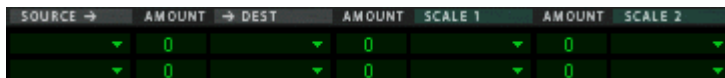

## Modulation Sources - Voice section

The following parameters can be used as Voice section modulation Sources:

Parameter	Description
Voice Key	<p>Voice Key lets you assign modulation according to notes. There are 4 modes selectable from the sub-menus:</p> <ul style="list-style-type: none"><li>• <b>Note - this is keyboard tracking. If a positive Amount value is used and the destination is filter frequency, the filter frequency will track the keyboard, i.e. increase with higher notes.</b></li><li>• <b>Note2 - this works similarly to Note but within a repeated octave range. E.g. if Note2 modulates Amp Pan the pan position will move from left to right within an octave range then start over. If you play chords normally over the keyboard the effect will be that notes are randomly spread across the stereo field.</b></li><li>• <b>Velocity - this applies modulation according to velocity (how hard or soft you strike the keys).</b></li><li>• <b>Gate - this is Gate on/off. E.g. if applied to oscillator pitch you will get one pitch value (set by Amount) when a key is pressed, and another value (the unmodulated pitch) when the key is released.</b></li></ul>
Osc 1/2/3	This allows you to route the audio output from the oscillators to a destination.
Filter 1/2	This is the audio output of the filters. All filter parameters affect the destination.
Shaper	This is the audio output of the Shaper module. Note that anything connected to the Shaper, e.g. Filter 1, affects the Shaper output, and thus the resulting modulation.
Amp	This is the audio output of the Amp Gain section.
LFO 1	This allows you to modulate parameters with LFO 1.
Filter Envelope	This allows you to modulate parameters with the Filter Envelope.
Amp Envelope	This allows you to modulate parameters with the Amp Envelope.
Mod Envelope	This allows you to modulate parameters with the Mod Envelope.

## Modulation Sources - Global

The following parameters can be used as Global section modulation Sources:

Parameter	Description
Global Envelope	This allows you to modulate parameters using the Global Envelope.
Voice Mixer	This allows you to modulate parameters using the Left and Right Mixer inputs.
Last Key	This will apply modulation according to the last note played (monophonic), either via MIDI, or from the Step Sequencer. For example, you can use Last Key to make a filter's frequency track notes played by the Step Sequencer.
MIDI Key	<p>This applies modulation according to notes globally, not per-voice so in other words it is monophonic. E.g. if you use MIDI Note as Source and a self-oscillating filter's frequency as the destination, the filter will track but you will only be able to play one voice at a time. MIDI Note is handy for transposing Step patterns in real time.</p> <p>There are 3 modes selectable from the sub-menus:</p> <ul style="list-style-type: none"><li>• <b>Note - this is keyboard tracking. If a positive Amount value is used and the destination is filter frequency, the filter frequency will track the keyboard, i.e. increase with higher notes.</b></li><li>• <b>Velocity - this applies modulation according to velocity (how hard or soft you strike the keys).</b></li><li>• <b>Gate - this is Gate on/off. E.g. if applied to oscillator pitch you will get one pitch value (set by Amount) when a key is pressed, and another value (the unmodulated pitch) when the key is released.</b></li></ul>
LFO 2	This allows you to modulate parameters with LFO 2.
Performance parameters	On this sub-menu you can assign the one of the standard Performance controllers to modulate/scale parameters; Mod Wheel/Pitch Bend/Breath/AfterTouch/Expression.
Modifiers	This is where you assign parameters and functions to be controlled with the virtual 2 Rotary and 2 Button controls on the Controller panel.
Sustain Pedal	This allows you to assign the Sustain Pedal as a modulation source.
Polyphony	This allows you to apply modulation according to how many notes you play. E.g. you could have a short envelope attack when you play single notes, and a long attack when you play chords.
Step Sequencer	<p>This allows you to apply modulation according to the settings for each step in the Step Sequencer.</p> <p>On the sub-menu you can chose to apply modulation according to Gate/Note/Curve 1 and 2/Gate Length/Step Duration settings for each step.</p> <p>In addition you have Start and End Trig, which sends a gate trigger at the start and end of the Step sequence, respectively.</p>
CV Inputs 1-4	These are CV inputs on the back panel which facilitates the use of external modulation sources, (e.g. the Matrix) in Thor. If connected you can freely assign the external CV to any modulation destination in Thor.
Audio Inputs 1-4	These are Audio inputs on the back panel which allows you to connect external audio signals and process these using Thor parameters, or use them as modulation sources. See <a href="#">"About using the Audio inputs"</a> .

## Modulation Destinations - Voice section

The following parameters can be used as Voice section modulation Destinations:

Parameter	Description
Osc 1	<p>There are four modulation destinations available on the Osc 1 sub-menu:</p> <ul style="list-style-type: none"><li>• <b>Pitch - this will affect oscillator pitch (frequency).</b></li><li>• <b>FM - this will frequency modulate the oscillator.</b> The difference between Pitch and FM is that if a high frequency audio signal (i.e. an oscillator or an external audio signal) is the source, FM will not alter the basic pitch of the source, only the timbre. If Pitch is used both the pitch and the timbre will be affected.</li><li>• <b>There is also a modifier parameter, which differs depending on what oscillator type is selected. See “The Oscillator section” for details.</b></li><li>• <b>Osc 2 AM Amount - this will control AM modulation amount from Osc 2. See “About Amplitude Modulation (AM)”.</b></li></ul>
Osc 2/ Osc 3	<p>Oscillator slots 2 and 3 have the same Destination parameters as Osc 1, except that there is no AM.</p>
Filter 1/ Filter 2	<p>The following destinations are available on the Filter 1 and 2 sub-menus:</p> <ul style="list-style-type: none"><li>• <b>Audio In - this allows you to connect an audio source (e.g. an oscillator or an external audio signal) to the filter input.</b></li><li>• <b>Frequency - this controls the filter frequency.</b></li><li>• <b>Frequency (FM) - this will apply filter frequency modulation.</b> The difference between Frequency and FM is that if a high frequency audio signal (i.e. an oscillator or an external audio signal) is the source, FM will not alter the basic frequency of the source, only the timbre. If Frequency is used both the pitch and the timbre will be affected.</li><li>• <b>Resonance - this controls filter resonance.</b></li><li>• <b>Drive - this controls the filter’s Drive parameter.</b></li><li>• <b>Gender - this controls the Gender parameter (Formant filter only).</b></li><li>• <b>LPHPMix - this controls the LP/HP parameter (State Variable filter only).</b></li></ul>
Shaper Drive	<p>This will control the Shaper Drive parameter.</p>
Amp	<p>The Amp section has three destinations on the sub-menu:</p> <ul style="list-style-type: none"><li>• <b>Input - this allows you to connect a source (e.g. an oscillator or an external audio signal) to the Amp input.</b></li><li>• <b>Gain - this controls the Amp Gain.</b></li><li>• <b>Pan - this controls the Pan for each voice. Modulating this parameter with for example LFO 1 means that the Pan position will modulate differently for each voice you play.</b></li></ul>
Mix	<p>The Mixer has three destinations on the sub-menu:</p> <ul style="list-style-type: none"><li>• <b>Osc 1+2 Level - this controls the level of both oscillator 1 and 2.</b></li><li>• <b>Osc 1:2 Balance - you can modulate the level balance between oscillator 1 and 2, e.g. to sweep from one oscillator to the other.</b></li><li>• <b>Osc 3 Level - this controls the level of oscillator 3.</b></li></ul>

Parameter	Description
Filter Envelope	The Filter Envelope mod destinations are as follows: <ul style="list-style-type: none"> <li>• <b>Gate - this is the gate input of the envelope. A gate signal applied to this input will trigger the envelope.</b></li> <li>• <b>Attack - this controls the Attack of the envelope.</b></li> <li>• <b>Decay - this controls the Decay of the envelope.</b></li> <li>• <b>Release - this controls the Release parameter.</b></li> </ul>
Amp Envelope	This has the same destination parameters as the Filter Envelope.
Mod Envelope	This has the same destination parameters as the Filter Envelope.
LFO 1 Rate	This allows you to control the LFO 1 Rate parameter.

## Modulation Destinations - Global

The following Global modulation destinations are available:

Parameter	Description
Portamento	This allows you to control the Portamento time parameter.
LFO 2 Rate	This allows you to control the LFO 2 Rate parameter.
Global Envelope	The Global Envelope mod destinations are as follows: <ul style="list-style-type: none"> <li>• <b>Gate - this is the gate input of the envelope. A gate signal applied to this input will trigger the envelope.</b></li> <li>• <b>Attack - this controls the attack time of the envelope.</b></li> <li>• <b>Decay - this controls the decay time of the envelope.</b></li> <li>• <b>Release - this controls the release time of the envelope.</b></li> </ul>
Filter 3	The following destinations are available on the Filter 3 sub-menu: <ul style="list-style-type: none"> <li>• <b>Left/Right In - this allows you to connect a source to the filter input.</b></li> <li>• <b>Frequency - this controls the filter frequency.</b></li> <li>• <b>Frequency (FM) - this will apply filter frequency modulation.</b></li> <li>• <b>Resonance - this controls filter resonance.</b></li> <li>• <b>Drive - this controls the filter's Drive parameter.</b></li> <li>• <b>Gender - this controls the Gender parameter (Formant filter only).</b></li> <li>• <b>LPHPMix - this controls the LP/HP parameter (State Variable filter only).</b></li> </ul>
Chorus	The Chorus effect has the following destinations: <ul style="list-style-type: none"> <li>• <b>DryWet balance</b></li> <li>• <b>Delay (time)</b></li> <li>• <b>ModRate</b></li> <li>• <b>ModAmount</b></li> <li>• <b>Feedback</b></li> </ul>

Parameter	Description
Delay	<p>The Delay effect has the following destinations:</p> <ul style="list-style-type: none"> <li>• <b>DryWet balance</b></li> <li>• <b>Time</b></li> <li>• <b>ModRate</b></li> <li>• <b>ModAmount</b></li> <li>• <b>Feedback</b></li> </ul>
Step Sequencer	<p>This allows you to control various parameters belonging to the Step Sequencer.</p> <ul style="list-style-type: none"> <li>• <b>Trig - this enables control over the Step Sequencer Run on/off status.</b></li> <li>• <b>Rate - this enables control over the Step Sequencer Rate.</b></li> <li>• <b>Transpose - this enables control over the Step Sequencer base pitch. E.g. if you apply MIDI Note as a source to this parameter you can transpose the sequence by playing notes.</b></li> <li>• <b>Velocity - this enables control over the Step Sequencer Velocity response.</b></li> <li>• <b>Gate Length - this enables control over the Step Sequencer Gate Length response.</b></li> </ul>
CV Output 1-4	<p>This will allow you to send signals to the CV outputs on the back of the device. Note that you can send CV signals to audio outputs and vice versa.</p>
Audio Output 1-4	<p>This will allow you to send signals to the audio outputs on the back of the device. Note that you can send CV signals to audio outputs and vice versa.</p>

## Scale parameters

The available scale parameters are the same as the Source parameters.

## About using the Audio inputs

The 4 Audio inputs on the back panel can be used to connect external audio sources and process them with Thor's parameters.

Note that when routing audio to the Voice section, the following things apply:

- **There are only mono inputs in the Voice section.**
- **You need to send a gate trigger for the audio signal to be heard. This can be done in three ways; by playing notes, via notes played by the Step sequencer or from CV gate signals.**
- **Routing audio to Global destinations does not require a gate trigger and stereo inputs are provided.**
- **The external audio sources can also be used purely for modulation, e.g. you can modulate an oscillators pitch with an audio signal.**

This way you can use the audio input source to modulate any available destinations.



# Step Sequencer



Thor's Step Sequencer is a further development of the step sequencers which were often present in vintage analog modular systems. It can be used for programming arpeggios or short melody sequences. Alternatively, it can be used purely as a modulation source.

You can have up to 16 steps, and each step can be programmed with various values such as Note pitch, Velocity, Step Duration etc.

## Basic operation

The main parameters and functions are as follows:

- **The row of 16 buttons are used to program each step's on or off status.**  
A lit button means that the step is active, and a dark button means that the step will be a rest (silent).
- **Each step button has a knob above it, which is used to set values for the corresponding step.**
- **The Edit knob determines what value you set with the step knobs.**  
The available Edit values are Note (pitch), Velocity, Gate length, Step duration and Curve 1 and 2.
- **The Run button starts/stops the step sequencer.**

What exactly happens when you press Run depends on the Run mode - see below.

## Setting the Run mode



The Run mode is set with the lever beside the Run button. The set mode governs how the step sequencer is played back when you press Run. The options are as follows:

- **Repeat mode - this will repeat the sequence continuously.**  
Click the Run button again or use the Transport to stop.
- **1 Shot mode - this will play the sequence once then stop.**
- **Step mode - the Run button steps the sequencer forward one step at a time.**
- **Off - the step sequencer is inactive.**

## Setting the direction



The Direction parameter is used to set the direction of the step sequence. The following options are available:

- **Forward** - plays the sequence from the first step to the last.
- **Reverse** - plays the sequence from the last step to the first.
- **Pendulum 1** - plays the sequence from the first step to the last, then from the last step to the first. I.e. the last and first step is played twice when the sequencer reverses direction.
- **Pendulum 2** - plays the sequence from the first step to the last, then from the second last step to the first, i.e. without repeating the last/first step when reversing direction.
- **Random** - plays the steps in a random order.

## Programming step note pitch

To program step note pitch, you proceed as follows:

1. **Make sure that the Step Seq Trigger button is activated in the Controller panel.**



2. **Set the Run mode to "Repeat".**

You don't have to use Repeat mode but it makes it easier to follow the following steps.

3. **Start the step sequencer by pressing the Run button.**

You should now hear a sequence of repeated notes, each with the same pitch (C3). The current step is indicated by a yellow LED above the step buttons.

4. **Make sure that the Edit knob is set to Note.**



## 5. Turn one of the step knobs above one of the steps.

A tooltip shows you what current note pitch the knob is set to, and when the sequencer repeats you should be able to hear the change in pitch for that step. Turn clockwise to raise the pitch in semitone increments. Turn counter-clockwise to lower the pitch.



### → You can set the knob's note range by using the Octave lever to the left of the step buttons.

Available note ranges are 2 Octaves (i.e. one octave up and down from the middle knob position (C3), 4 Octaves (i.e. two octaves up and down from the middle position (C3), or Full (-C2 to G8).

### - Note that the octave range can be set independently for each step. Each step memorizes the current octave range when the pitch is set for that step, and will keep this octave range until you change the pitch for the step with a different octave range setting.

### → You can either program steps “on the fly” (with the Step sequencer running) or step by step (Step mode).

In Step mode, you press Run to forward the step number one position so you can set step parameters for one step at a time.

By using this general method you can continue to enter note pitch for other steps.

## Inserting rests

To make step sequences more rhythmically interesting, you can program rests for steps.

### → This is simply done by pressing one or several step buttons so they go dark.

Dark steps will be rests.

### → Note that the Step Duration value still “counts” for rests.

## Setting the number of steps

### → You can set how many steps a sequence should have before starting over using the Steps knob at the far right on the panel.

Up to 16 steps can be used. The lit LEDs above each step button show the number of steps currently used. You can also change number of steps by clicking on a LED directly - the sequencer will then stop/start over at the selected step.



## Setting Rate

The Rate knob determines the rate of the step sequence.

- **You can either use “free running” rates (i.e. not synced to main sequencer tempo) or synced tempo.**  
This is set with the Sync button on/off status. If Sync is active you can set the tempo in various beat resolutions.

## Setting other values for steps

For each step you can also program other parameters with the step value knobs apart from note pitch. You use the Edit knob to set one the following:

- **Velocity - if this is selected as the Edit mode you can set a velocity value for each step.**  
Default value is 100, range is 0-127.
- **Gate Length - if this is selected as the Edit mode you can set a Gate Length value for each step.**  
Default is 75%. Gate Length determines the length of the note played for that step.
- **Step Duration - if this is selected as the Edit mode you can set a Step duration value for each step.**  
This parameter determines the total length of the step, which is a factor related to the sequencer rate. Range is 1/4 to 4. E.g. if Rate is 1/16, “1” means a 1/16-note will be played, a “4” means a 1/4-note will be played, and so on.
- **The Curves 1 and 2 allow you to set values for each step that can be sent to control parameters of your choice.**  
This is done in the Modulation bus routing section, where these two independent Curves are selectable as Source controllers.
- **You can compare these curves to the Curve CV output of the Matrix - they simply represent a series of values which can be applied to anything.**

## Step Pattern functions

You will find some specific Step pattern functions on the Edit menu (and on the device context menu). These are as follows:

Function	Description
Randomize Sequencer Pattern	The Randomize Pattern function creates random patterns. The function only randomizes the selected Edit value (e.g. if set to Note, only the note pitch values are randomized, not velocity, gate length etc.).
Shift Pattern L/R	The Shift Pattern functions move the pattern one step to the left or right. All parameters (rests, note pitch, velocity etc.) are shifted one step.

# Connections

The following Audio and CV connectors can be found at the back of Thor:

## Sequencer Control Inputs

The Sequencer Control CV and Gate inputs allow you to play Thor from another CV/Gate device (e.g. a Matrix or the RPG-8). The signal to the CV input controls the note pitch, while the signal to the Gate input delivers note on/off along with velocity.

## Modulation Inputs

- **The Rotary control voltage (CV) inputs (with associated voltage trim pots), can modulate the two virtual Rotary controls.**  
Thus, any parameter(s) assigned to a Rotary control can be modulated by CV.
- **The Filter 1x allows for CV control of the Filter 1 frequency.**  
If the Formant filter is used this is the "X" parameter - see ["Formant filter"](#).
- **The four CV Inputs can receive CV from external sources that will be available as Sources in the Modulation bus.**

## Modulation Outputs

Here you can find CV outputs from the Global Envelope and LFO 2, as well as the 4 user assignable CV outputs.

## Audio Inputs

The Audio inputs can be used to connect audio outputs from other Reason devices. When connected, you can route the Audio inputs as a Modulation source to for example one of the filters and process the external signal. See ["About using the Audio inputs"](#).

## Audio Outputs

Thor has 4 outputs:

- **1 Left (Mono)/2 Right - these are the main stereo outputs.**
- **2 additional outputs (3 and 4), which can be assigned in the Modulation section.**



# **Chapter 31**

## **Malström Synthesizer**

# Introduction

The Malström is a polyphonic synthesizer with a great number of different routing possibilities. It is based on the concept of what we call "Grainable Synthesis" (see below), and is ideally suited for producing swirling, sharp, distorted, abstract special effect types of synthesizer sounds. In fact, you could go so far as to say that the Malström can produce sounds quite unlike anything you've ever heard from a synthesizer.

For a complete run-down of the principles behind it and thorough explanations of the controls, read on...

## Features

The following are the basic features of the Malström:

- **Two Oscillators, based on Grainable Synthesis.**  
See "[The Oscillator section](#)" for details.
- **Two Modulators, featuring tempo sync and one-shot options.**  
See "[The Modulator section](#)".
- **Two Filters and one Shaper.**  
A number of different filter modes in combination with several routing options and a Waveshaper makes it possible to create truly astounding filter effects.
- **Three Envelope generators.**  
There is one amplitude envelope for each oscillator and a common envelope for both filters. See "[The amplitude envelopes](#)" and "[The Filter Envelope](#)" for details.
- **Polyphony of up to 16 voices.**
- **Velocity and Modulation control.**  
See "[The Velocity controls](#)".
- **A number of CV/Gate Modulation possibilities.**  
See "[Modulation Input](#)".
- **A variety of Audio Input/Output options.**  
You can for instance connect external audio sources for input to the Malström, and you can also control its output. See "[Audio Input](#)" for more details.



## Theory of operation

There are a number of different synthesis methods for generating sound, e.g. subtractive synthesis (which is used in the Subtractor), FM synthesis, and physical modelling synthesis to mention but a few.

To give you a clear understanding of the inner workings of the Malström, it might be in order with a brief explanation of what we call Grintable Synthesis.

What we refer to as grintable synthesis is actually a combination of two synthesis methods, granular synthesis and wavetable synthesis.

- **In granular synthesis, sound is generated by a number of short, contiguous segments (grains) of sound, each typically from 5 to 100 milliseconds long.**

The sound is varied by changing the properties of each grain and/or the order in which they are spliced together. Grains can be produced either by a mathematical formula or by a sampled sound. This is a very dynamic synthesis method capable of producing a great variety of results, although somewhat hard to master and control.

- **Wavetable synthesis on the other hand, is basically the playback of a sampled waveform.**

An oscillator in a wavetable synth plays back a single period of a waveform, and some wavetable synths also allow for sweeping through a set of periodic waveforms. This is a very straightforward synthesis method, easily controlled, but somewhat more restricted in results. The Malström combines these two into a synthesis method that provides a very flexible way of synthesizing sounds with incredible flux and mutability.

The Malström combines these two into a synthesis method that provides a very flexible way of synthesizing sounds with incredible flux and mutability.

It works like this:

- **The oscillators in the Malström play back sampled sounds that have been subjected to some very complex processing and cut up into a number of grains.**
- **A set of these periodic waveforms (grains) are spliced together to form a Grintable, which may be played back to reproduce the original sampled sound.**
- **A Grintable may be treated just like a wavetable; e.g., you may choose to sweep through it, to move through it at any speed without affecting pitch, to play any section of it repeatedly, to select from it static waveforms, to jump between positions, etc., etc.**
- **It is also possible to perform a number of other tricks, all of which are described further on in this chapter.**

## Loading and Saving Patches

Loading and saving patches is done in the same way as with any other Reason device - see [“Loading patches”](#) and [“Saving patches”](#).

# The Oscillator section



The two oscillators (osc:A and osc:B) of the Malström are the actual sound generators, and the rest of the controls are used for modulating and shaping the sound. The oscillators actually do two things; they play a graintable and generate the pitch:

- **A graintable is several short, contiguous segments of audio (see above).**
- **Pitch is the frequency at which the segments are played back.**

When creating a Malström patch, the fundamental first building block is usually to select a graintable for one or both of the oscillators.

- **To activate/deactivate an oscillator, click the On/Off button in the top left corner.**

When an oscillator is activated, the button is lit.



*An activated oscillator.*

- **To select a graintable, either use the spin controls or click directly in the display to bring up a pop-up menu with the available graintables.**

The graintables are sorted alphabetically into a number of descriptive categories, giving a hint as to the general character of the sound. Note that the categories are only visible in the pop-up menu, not in the display.

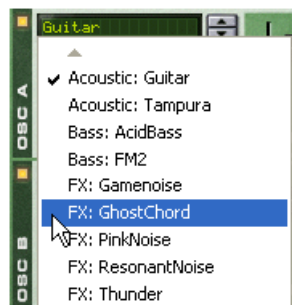

*Selecting a graintable by clicking in the Oscillator display.*

## Setting oscillator frequency

You can change the frequency - i.e. the tuning - of each oscillator by using the three knobs marked “Octave”, “Semi” and “Cent”.



- **The Octave knob changes the frequency in steps of one full octave (12 semitones).**  
The range is -4 – 0 – +4 where 0 corresponds to middle “A” on your keyboard at 440 Hz.
- **The Semi knob changes the frequency in steps of one semitone.**  
The range is 0 to +12 (one full octave up).
- **The Cent knob changes the frequency in steps of cents, which are 100ths of a semitone.**  
The range is -50 – 0 – +50, i.e. down or up by up to half a semitone.

## Controlling playback of the graintable

Each oscillator features three controls that determine how the loaded graintables are played back. These are: The “Index” slider, the “Motion” knob and the “Shift” knob.



- **The Index slider sets the playback starting point in the graintable.**  
By dragging the slider, you set which index point in the graintable should be played first when the Malström receives a Note On message. Playback will then continue to the next index point according to the active graintable. With the slider all the way to the left, the first segment in the graintable is also the one that will be played back first.
- ! **Note that the Malström’s Graintables are *not* all of the same length, and that the range for the Index slider (0-127) does not reflect the actual length of the graintables. I.e. regardless of whether a graintable contains 3 or 333 grains, the Index slider will always span the entire graintable even though the slider range says 0-127.**
- **The Motion knob controls how fast the Malström should move forward to play the next segment in the graintable, according to its motion pattern (see below).**  
If the knob is kept in the middle position the speed of motion is the normal default. Turning the knob to the left slows it down and turning it to the right results in higher speed. If the knob is set all the way to the left, there will be no motion at all, which means that the initial segment, as set with the Index slider, will play over and over as a static waveform.
- **The Shift knob changes the timbre of the sound (the formant spectrum).**  
What it actually does is change the pitch of a segment up or down by re-sampling. However, since the pitch you *hear* is independent of the actual pitch of the graintable (see above), pitch-shifting a segment instead means that more or less of the segment waveform will be played back, resulting in a change of harmonic content and timbre.

## About motion patterns

Each graintable has a predefined motion pattern and a default motion speed.

When a graintable is looped (i.e. if the Motion knob is *not* set all the way to the left), it follows one of two possible motion patterns:

→ **Forward**

This motion pattern plays the graintable from the beginning to the end, and then repeats it.

→ **Forward - Backward**

This motion pattern plays the graintable from the beginning to the end, then from the end to the beginning and then repeats it.

The motion speed can be changed with the Motion knob, as described above, but it is *not* possible to alter the motion pattern of a graintable.

## The amplitude envelopes

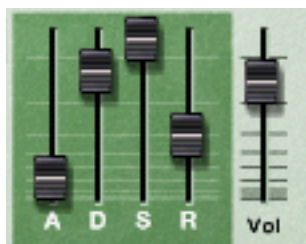

Each oscillator features a standard ADSR (Attack, Decay, Sustain, Release) envelope generator, and a Level control. These are used for controlling the volume of the oscillator. One thing that makes the Malström different from many other synths though, is the fact that the amplitude envelopes are placed *before* the filter and routing sections in the signal path.

The amplitude envelopes control how the volume of a sound should change from the moment you strike a key on your keyboard to the moment that you release it again.

### Vol

The Volume knobs set the volume level out from each oscillator.

**! For an overall description of the general envelope parameters (Attack, Decay, Sustain, Release), please refer to the Subtractor chapter.**

# The Modulator section



The Malström features two Modulators (mod:A and mod:B) These are in fact another type of oscillators, called LFOs (Low Frequency Oscillators). They each generate a waveform and a frequency, much like osc:A and osc:B. However, there are a couple of important differences:

- **Mod:A and mod:B do not generate sound. They are instead used for modulating various parameters to change the character of the sound.**
- **They only generate waveforms of low frequency.**

Furthermore, both modulators are tempo syncable and possible to use in one shot mode, in which case they will actually work like envelopes.

## Modulator parameters

The two Modulators have a few controls in common, but there are also some differences. Both the common parameters and the ones that are unique for each Modulator (the destinations) are described below.

- **To activate/deactivate a Modulator, click the On/Off button in the top left corner.**

When a Modulator is activated, the button is lit.



*An activated Modulator.*

## Curve

This lets you select a waveform for modulating parameters. Use the spin controls to the right of the display to cycle through the available waveforms. Some of these waveforms are especially suited for use with the Modulator in one shot mode (see below).

## Rate

This knob controls the frequency of the Modulator. For a faster modulation rate, turn the knob to the right.

The Rate knob is also used for setting the time division when synchronizing the Modulator to the song tempo (see below).

## One Shot

To put the Modulator into one shot mode, click this button so that it is lit.

Normally, the Modulators will repeat the selected waveforms over and over again, at the set rate. However, when one shot mode is activated and you play a note, the Modulator will play the selected waveform only once (at the set rate) and then stop. In other words, it will effectively be turned into an envelope generator!

Note that even though all waveforms can be used with interesting results, some waveforms are explicitly well suited for use in one shot mode. For example, try using the waveform with just one long, gently sloping curve.

## Sync

Clicking this button so that it is lit synchronizes the Modulator to the song tempo, in one of 16 possible time divisions.

**! When sync is activated, the Rate knob is used for selecting the desired time division. Turn the Rate knob and observe the tool tip for an indication of the time division.**

## A/B selector

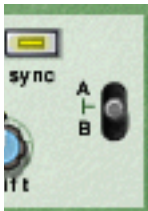

This switch is used for deciding which oscillator and/or filter the Modulator should modulate - A, B or both. With the switch in the middle position, both A and B will be modulated.

## Destinations

The following knobs are used for determining what each of the two modulators should modulate.

- **Note that these knobs are bi-polar, which means that if a knob is in the middle position, no modulation is applied. If you turn a knob either to the left or to the right, an increasing amount of modulation is applied to the parameter. The difference is that if you turn a knob to the left, the waveform of the modulator is inverted.**

## Mod:A



Mod:A can modulate the following parameters of either oscillator:

- **Pitch**  
Use this if you want Mod:A to offset the pitch of osc:A, osc:B, or both (see [“Setting oscillator frequency”](#)).
- **Index**  
Use this if you want Mod:A to offset the index start position of osc:A, osc:B, or both (see [“Controlling playback of the graintable”](#)).
- **Shift**  
Use this to have Mod:A affect the harmonic content of osc:A, osc:B, or both (see [“Controlling playback of the graintable”](#)).

## Mod:B



Mod:B can modulate the following parameters of either oscillator:

- **Motion**  
Use this if you want Mod:B to affect the motion speed of osc:A, osc:B, or both (see “Controlling playback of the graintable”).
- **Vol**  
Use this if you want Mod:B to change the output level of osc:A, osc:B, or both (see “Vol”).
- **Filter**  
Use this if you want Mod:B to offset the cutoff frequency of filter:A, filter:B, or both (see “Filter controls”).
- **Mod:A**  
Use this if you want Mod:B to change the total amount of modulation from Mod:A.

## The Filter section

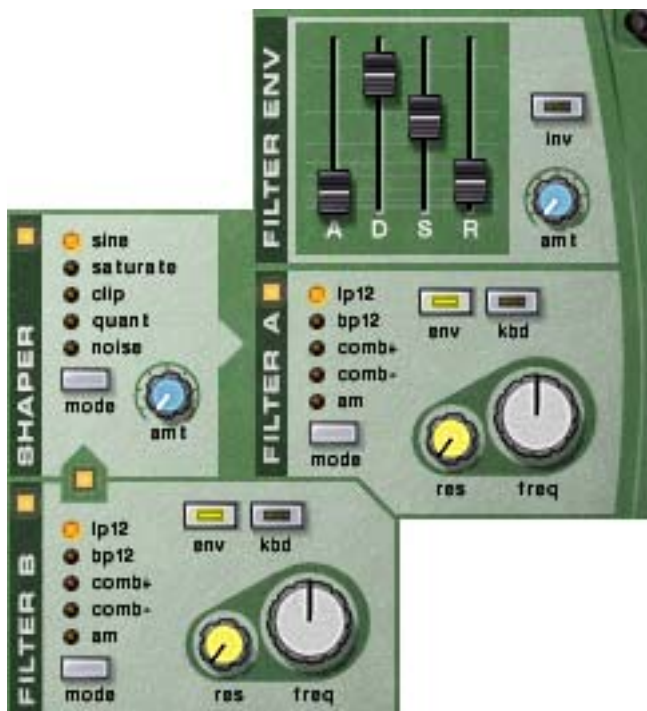

The filter section lets you further shape the overall character of the sound. Contained herein are two multimode filters, a filter envelope and a waveshaper.

# The Filters

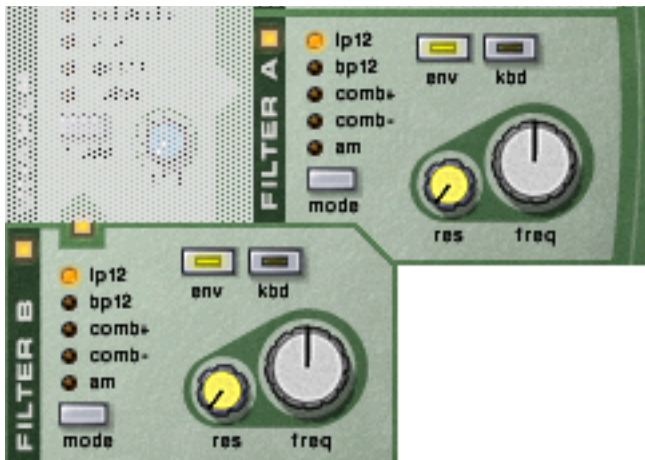

Both filter:A and filter:B have the exact same parameters, all of which are described below.

→ **To activate/deactivate a filter, click the On/Off button in the top left corner.**

When a filter is activated, the button is lit.



*An activated filter.*

## Filter types

To select a filter type, either click the Mode button in the bottom left corner or click directly on the desired filter name so that it lights up in yellow:

- **LP 12 (12 dB lowpass)**  
Lowpass filters let low frequencies through and cut off high frequencies. This filter type has a roll-off curve of 12dB/Octave.
- **BP 12 (12 dB bandpass)**  
Bandpass filters cut both high and low frequencies, leaving the frequency band in between unaffected. Each slope in this filter type has a 12 dB/Octave roll-off.



- **Comb + & Comb -**

Comb filters are basically delays with very short delay times with adjustable feedback (in Reason controlled with the Resonance knob). A comb filter causes resonating peaks at certain frequencies.

The difference between “+” and “-” is in the position of the peaks, in the spectrum. The main audible difference is that the “-”-version causes a bass cut.

The Resonance parameter in both cases controls the shape and size of the peaks.

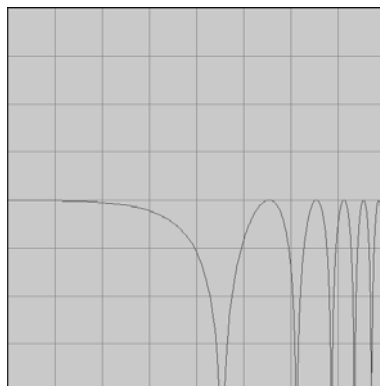

*Comb + Low Resonance.*

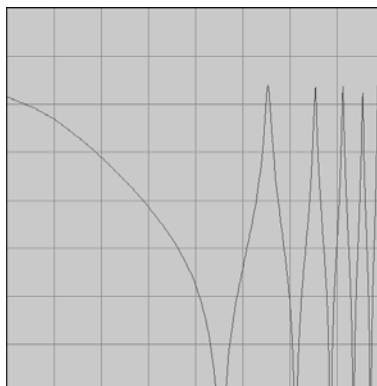

*Comb + High Resonance.*

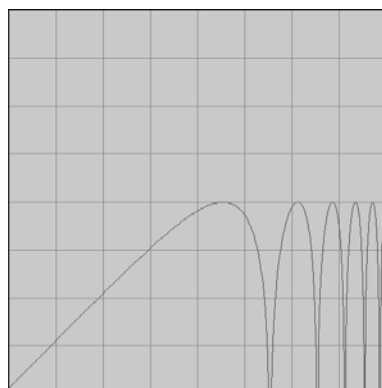

*Comb - Low Resonance.*

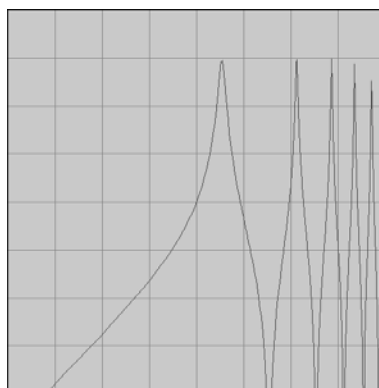

*Comb - High resonance.*

- **AM**

AM (Amplitude Modulation) is often referred to as Ring Modulation. A Ring Modulator works by multiplying two signals together. In the case of the Malström, the filter produces a sine wave which is multiplied with the signal from osc:A or osc:B. Resonance controls the mix between the clean and modulated signals. The Ring Modulated output will then contain added frequencies which are generated by the sum of, and the difference between the two signals. This can be used for creating complex, non-harmonic sounds.

## Filter controls

Each filter contains the following four controls:

- **Kbd (keyboard tracking)**

By clicking this button so that it is lit, you activate keyboard tracking. If keyboard tracking is activated, the frequency of the filter will change according to the notes you play on your keyboard. That is, if you play notes higher up on the keyboard, the filter frequency will increase and vice versa. If keyboard tracking is deactivated, the filter frequency will remain at a fixed value regardless of where on the keyboard you play.

- **Env (envelope)**

If you click on this button so that it is lit, the cutoff frequency (see below) will be modulated by the filter envelope. If you leave this deactivated, the Filter Envelope will have no effect.

- **Freq (frequency)**

The function of this parameter depends on which filter type you have selected:

With all filter types except AM, it is used for setting the cutoff frequency of the filter. In the case of the lowpass filter for example, the cutoff frequency determines the limit above which high frequencies will be cut off. Frequencies below the cutoff frequency will be allowed to pass through. The farther to the right you turn the knob, the higher the cutoff frequency will be.

If you have selected AM as filter type, this will instead control the frequency of the signal generated by the filter. The same control range applies though; the farther to the right you turn the knob the higher the frequency will be.

- **Res (resonance)**

Again, the function of this parameter depends upon which filter type is selected:

If the selected filter is any other type than AM, it sets the filter characteristic, or quality. For the lowpass filter for example, raising the filter Res value will emphasize the frequencies around the set filter frequency. This generally produces a thinner sound, but with a sharper, more pronounced filter frequency "sweep". The higher the filter Res value, the more resonant the sound becomes until it produces a whistling or ringing sound. If you set a high value for the Res parameter and then vary the filter frequency, this will produce a very distinct sweep, with the ringing sound being very evident at certain frequencies.

In the case of the AM filter type though, this control instead regulates the balance between the original signal and the signal resulting from amplitude modulation. The farther to the right you turn the knob, the more dominant the AM signal will be.

## The Filter Envelope

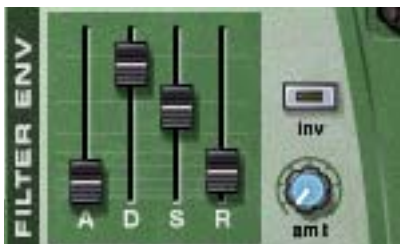

This is a standard ADSR envelope with two additional controls; inv and amt. The filter envelope is common for both filter:A and filter:B, and controls how the filter frequency should change over time.

### Inv (inverse)

This button toggles inversion of the envelope on and off. The Decay segment of the envelope will for instance normally lower the frequency, but if the envelope is inverted it will instead raise the frequency.

### Amt (amount)

This controls to which extent the filter envelope affects the filters, or rather - the set filter cutoff frequencies. For example; if the cutoff frequency is set to a certain value, the filter will already be opened by this amount when you hit a key on your keyboard. The amount setting then controls how much more the filter will open from that point. Turn the knob to the right to increase the value.

! **For an overall description of the general envelope parameters (Attack, Decay, Sustain, Release), please refer to the Subtractor chapter.**

# The Shaper



Before filter:A is an optional waveshaper. Waveshaping is a synthesis method for transforming sounds by altering the waveform shape, thereby creating a complex, rich sound. Or, if that's more to your taste, truncating and distorting the sound to lo-fi heaven!

A guitar distortion box could be viewed as a type of waveshaper for example. An unamplified electric guitar produces a sound with fairly pure harmonic content, which is then amplified and transformed by the distortion box.

→ **To activate/deactivate the Shaper, click the On/Off button in the top left corner.**

When the Shaper is activated, the button is lit.



*The Shaper activated*

## Mode

You can select one of five different modes for shaping the sound, each with its own characteristics.

To select a mode, either click the Mode button in the bottom left corner or click directly on the desired mode name so that it lights up in yellow.

- **Sine**  
This produces a round, smooth sound.
- **Saturate**  
This gives a lush, rich character to the sound.
- **Clip**  
This introduces clipping - digital distortion - to the signal.
- **Quant**  
This lets you truncate the signal by bit-reduction, thus making it possible to achieve that noisy, characteristic 8 bit sound for example.
- **Noise**  
This is actually not strictly a shaper function. Instead it multiplies the sound with noise.

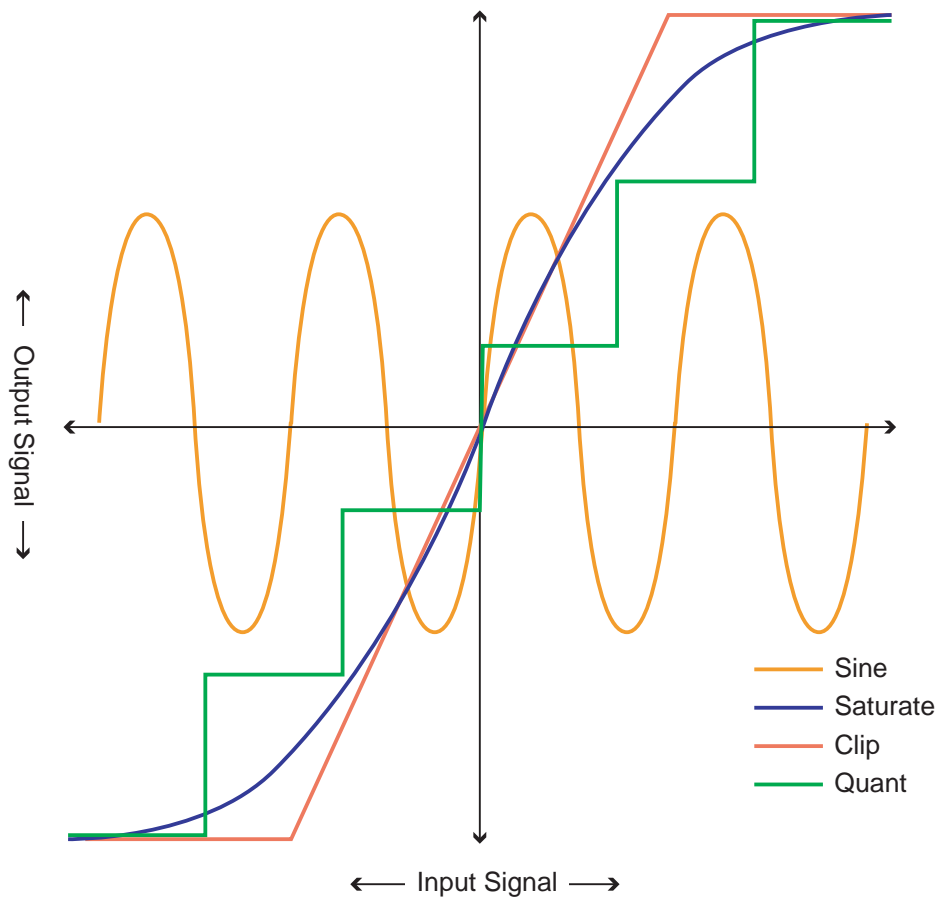

### Amt (amount)

This controls the amount of shaping applied. By turning the knob to the right you increase the effect.

# Routing

The Malström puts you in total control of how the signal should be routed from the oscillators, through the filters and on to the outputs. Below is first a general description of the routing options, followed by examples of how to route the signal in order to achieve a certain result.

→ **Click on a button so that it is lit, to route the signal correspondingly.**

See below for descriptions.

*If this button is lit, the signal from osc:A is routed to filter:A via the shaper. If neither this nor the other routing button from osc:A (to filter:B) is lit, the signal will go straight to the outputs.*

*If this button is lit, the signal from osc:A is routed to filter:B. If neither this nor the other routing button from osc:A (to filter:A/shaper) is lit, the signal from osc:A will go straight to the outputs.*

*If this button is lit, the signal from osc:B is routed to filter:B. If this is not lit, the signal from osc:B will go straight to the outputs.*

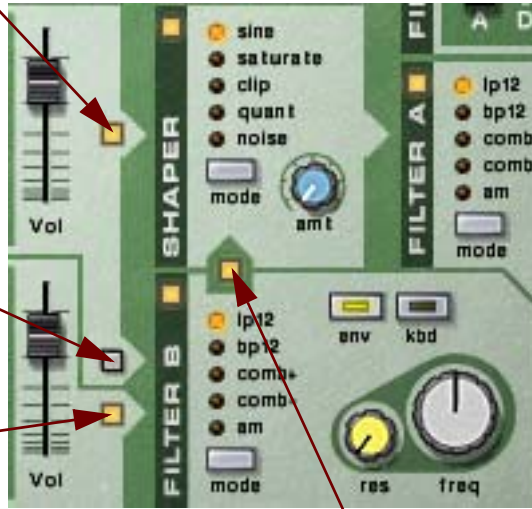

*If this button is lit, the signal from filter:B is routed to filter:A via the shaper. The signal from filter:B can originate from either osc:A, osc:B or both. If this is not lit, the signal from filter:B will go straight to the outputs.*

**! Note that the result depends both on the routing buttons and on whether the filters and shaper are activated or not!**

# Routing examples

## One or both oscillators without filters

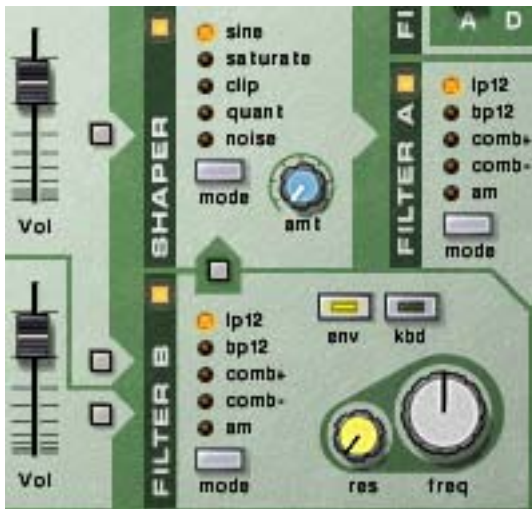

With this configuration, the signals from the oscillators will bypass the filters and the shaper and go directly to the respective output. Using both oscillators allows you to use the Spread parameter to create a true stereo sound.

## One or both oscillators to one filter only

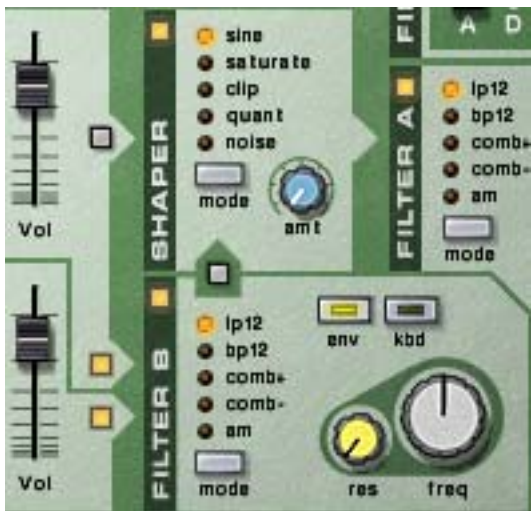

*Both oscillators routed to filter:B only.*

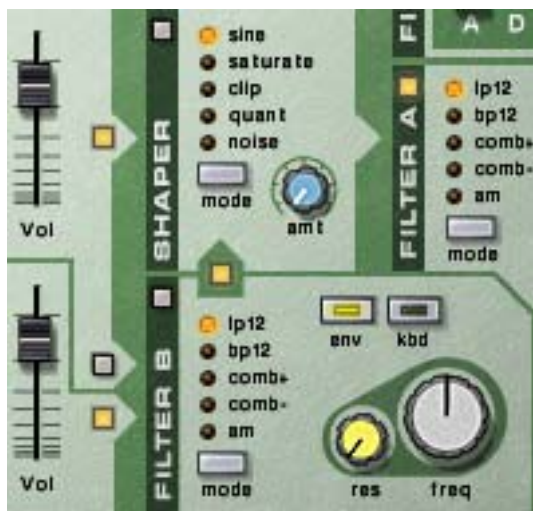

*Both oscillators routed to filter:A only.*

With these configurations, the signal from osc:A and/or osc:B will go to either filter:A or filter:B and then to the outputs. This is essentially a mono configuration and hence Spread should probably be set to "0".

## Both oscillators to one filter each

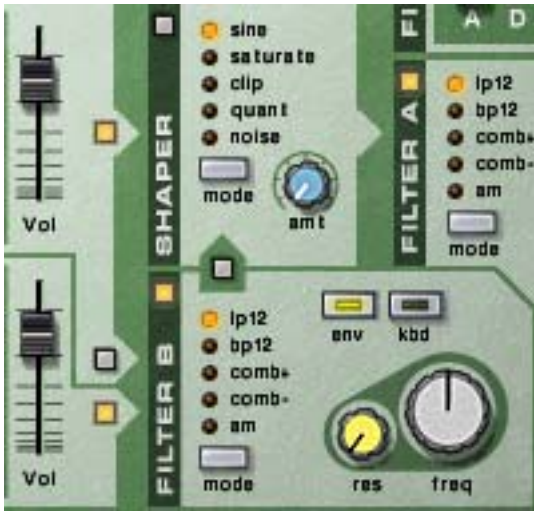

With this configuration, the signals from osc:A and osc:B will go to filter:A and filter:B respectively, and then to the outputs.

Again, this configuration allows you to work in true stereo.

## Oscillator A to both filters in parallel

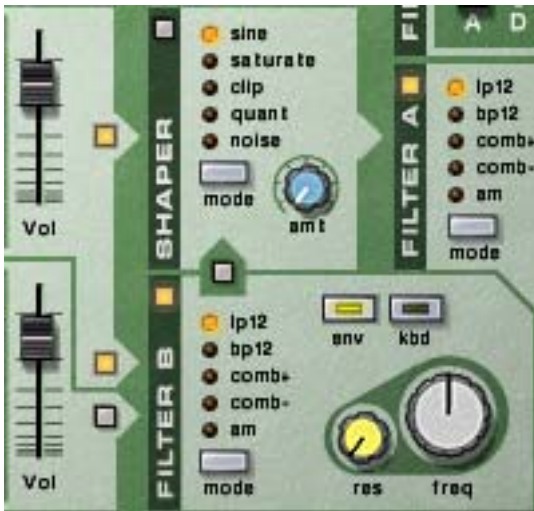

With this configuration, the signal from osc:A will go to both filter:A and filter:B, with the filters in parallel.

**! This configuration is only possible with osc:A. Osc:B can be routed to both filters as well, but only in series (see below).**

## One or both oscillators with both filters in series

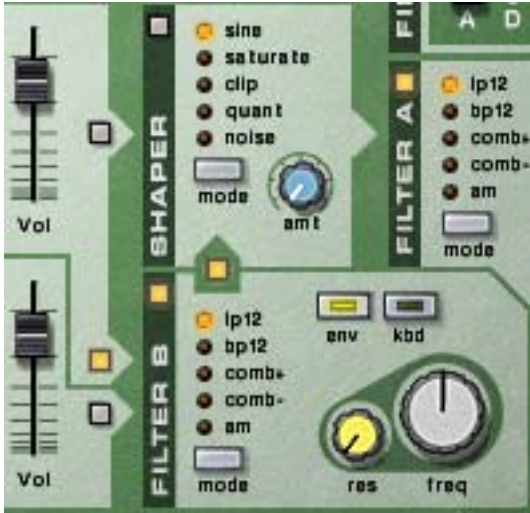

Osc:A routed through both filters in series.

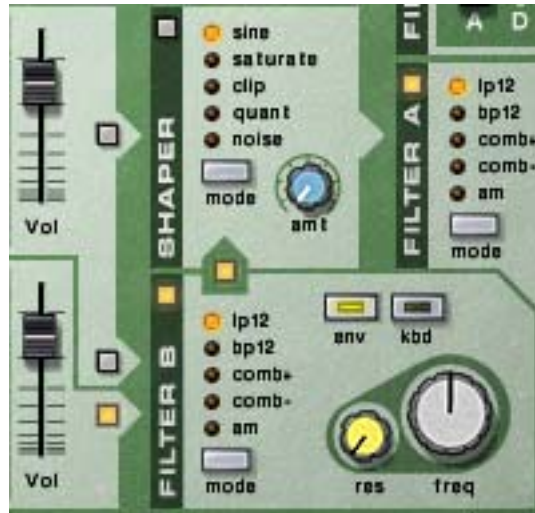

Osc:B routed through both filters in series.

With these configurations, the signal from osc:A and/or osc:B will go to both filter:A and filter:B, with the filters in series (one after the other).

## Adding the shaper

The signal from one or both oscillators can also be routed to the shaper. The signal will then pass through the shaper to the outputs, with or without also passing through the filters.

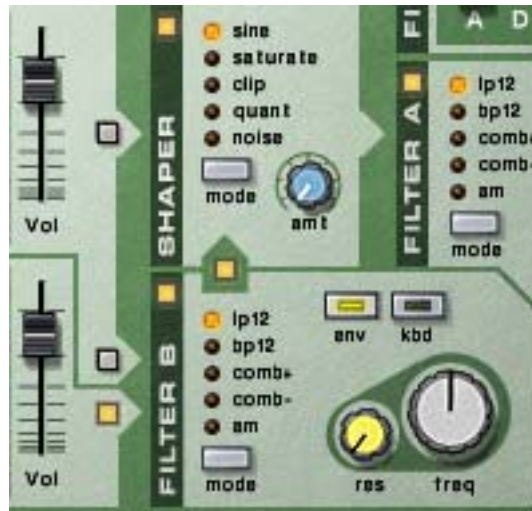
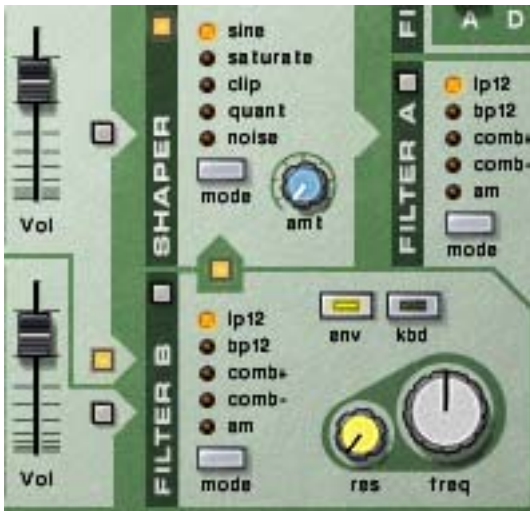

In the left figure, the signal from osc:A is routed to the shaper and then directly to the outputs. In the right figure, the signal from osc:B is routed to filter:B, then to the shaper and then to filter:A.



## The output controls



These two parameters control the output from the Malström in the following way:

### Volume

This knob controls the master volume out from the Malström.

### Spread

This controls the stereo pan-width of the outputs from Osc:A/B and Filter:A/B respectively. The farther to the right you turn the knob, the wider the stereo image will be. In other words, the signals will be panned further apart to the left and right.

**! If you are only using one output (A or B), it is strongly recommended that you set Spread to "0".**

## The play controls



To the far left on the Malström's "control panel" are various parameters that are affected by how you play, and lets you apply modulation by MIDI controls. The following is a description of these controls.

## Polyphony - setting the number of voices



This lets you set the polyphony for the Malström. Polyphony is the number of voices it can play simultaneously. The maximum number is 16 and the minimum is 1, in which case the Malström will be monophonic.

! **The number of voices you can play depends of course on the capacity of your computer. Even though the maximum number is 16 it doesn't necessarily mean that your system is capable of using that many voices. Also note that voices do not consume CPU capacity unless they are really "used". That is, if you are using a patch that plays two voices but have polyphony set to four, the two "unused" voices do not consume any of your system resources.**

## Porta (portamento)



This is used for controlling portamento. This is a parameter that makes the pitch glide between the notes you play, rather than changing the pitch instantly as soon as you hit a key on your keyboard. By turning this knob you set how long it should take for the pitch to glide from one note to the next as you play them.

With the knob turned all the way to the left, portamento is disabled.

## Legato

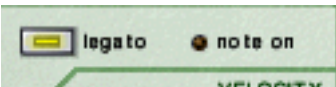

By clicking this button you activate/deactivate Legato. Legato in Malström is unique in that it allows you to control whether the sound is monophonic or polyphonic by using your playing style:

- **If you play legato (hold down a key and then press another key without releasing the previous), the sound is monophonic.**  
Also note that the pitch changes, but the envelopes do not start over. That is, there will be no new "attack".
- **If you play non-legato (separated notes), with polyphony set to more voices than 1, each note will decay separately (polyphonic).**  
This will be most apparent with longer release times.

## The Pitch Bend and Modulation wheels



- **The Pitch Bend wheel is used for bending the pitch of notes, much like bending the strings on a guitar or other string instrument.**
- **The Modulation wheel can be used for applying modulation while you are playing.**

Virtually all MIDI keyboards have Pitch Bend and Modulation controls. The Malström does not only feature the settings for how incoming MIDI Pitch Bend and Modulation wheel messages should affect the sound, but also two functional wheels that can be used for applying real time modulation and pitch bend if you don't have these controllers on your keyboard, or if you aren't using a keyboard at all. The wheels on the Malström also mirror the movements of the wheels on your MIDI keyboard.

### Pitch Bend Range

The Range parameter sets the maximum amount of pitch bend, i.e. how much it is possible to change the pitch by turning the wheel fully up or down. The maximum range is 24 semitones (2 Octaves). You change the value by clicking the spin controls to the right of the display.

## The Velocity controls



Velocity is used for controlling various parameters according to how hard or soft you play notes on your keyboard. A typical use of velocity control is to make sounds brighter and louder if you strike a key harder. By using the knobs in this section, you can control how much the various parameters will be affected by velocity.

- ! **All of the velocity control knobs are bi-polar, which means that the amount can be set to either positive or negative values, while keeping the knobs in the center position means that no velocity control is applied.**

The following parameters can be velocity controlled:

- **Lvl:A**  
This lets you velocity control the output level of osc:A.
- **Lvl:B**  
This lets you velocity control the output level of osc:B.

- **F.env**  
This sets velocity control for the Filter Envelope Amount parameter. Positive values will increase the envelope amount the harder you play, and negative values will decrease the amount.
  - **Atk (attack)**  
This sets velocity control for the Amp Envelope Attack parameter of osc:A and/or osc:B. Positive values will increase the Attack time the harder you play, and negative values will decrease it.
  - **Shift**  
This lets you velocity control the Shift parameter of osc:A and/or osc:B.
  - **Mod**  
This lets you velocity control all modulation amounts of mod:A and/or mod:B.
- ! **Note that you can set the last three parameters (Atk, Shift and Mod) to be velocity controlled for either or both of oscillator/modulator A and B. This is done with the A/B selector switch.**

## The Modulation wheel controls



The Modulation wheel can be set to control a number of parameters. You can set positive or negative values, just like in the Velocity Control section (see above).

The following parameters can be affected by the modulation wheel:

- **Index**  
This sets modulation wheel control of the currently active graintable's index (see [“Controlling playback of the graintable”](#)) for osc:A and/or osc:B. Positive values will move the index position forwards if the modulation wheel is pushed forward. Negative values will move it backwards.
  - **Shift**  
This sets modulation wheel control of the Shift parameter of osc:A and/or osc:B (see [“Controlling playback of the graintable”](#)).
  - **Filter**  
This sets modulation wheel control of the Filter Frequency parameter (see [“Filter controls”](#)). Positive values will raise the frequency if the wheel is pushed forward and negative values will lower the frequency.
  - **Mod**  
This sets modulation wheel control of the total amount of modulation from mod:A and/or mod:B. Positive values will increase the settings if the wheel is pushed forward and negative values will decrease the settings.
- ! **You can set whether these parameters on either or both oscillator/modulator/filter A and B will be affected by the modulation wheel. This is done with the A/B selector switch.**

# Connections

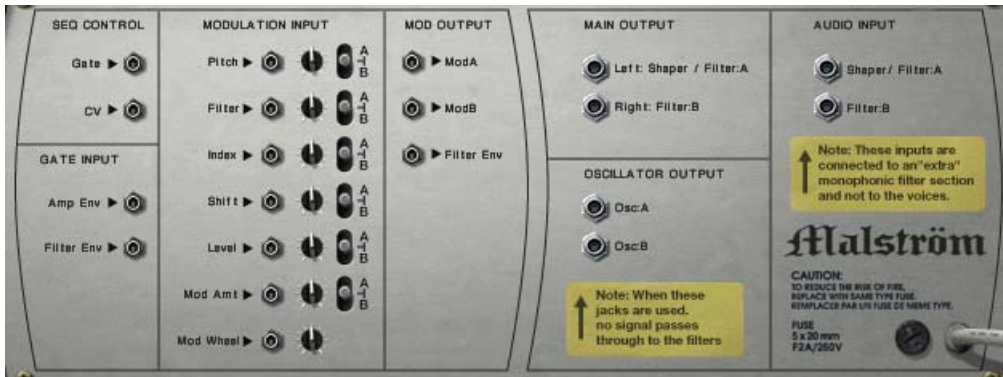

Flipping the Malström around reveals a wide array of connection possibilities. Most of these are CV/Gate related. Using CV/Gate is described in the chapter “Routing Audio and CV”.

## Audio Output

These are the Malström’s audio outputs. When you create a new Malström device, they are auto-routed to the first available channel on the audio mixer:

- **Shaper/Filter:A (left) & Filter:B (right)**

These are the main stereo outputs. Each of the two filters are connected to a separate output, and by connecting both, you can have stereo output. Whether the output really will be in stereo however, is determined by the routing and the Spread parameter. See “Routing” for details about this.

- **Osc:A & osc:B**

These make it possible to output the sound directly after the Amp Envelope of each oscillator, bypassing the filter section. Connecting one or both of these to a channel on the audio mixer will break the Malström’s internal signal chain. That is, it is not possible to process the sound by using the filters and the shaper of the Malström. the sound instead goes directly to the mixer.

- **Note also that you can connect the outputs Osc:A & Osc:B to the Audio Inputs on the Malström for some interesting effects - see “Routing external audio to the filters”.**

## Audio Input

- **Shaper/Filter:A**

- **Filter:B**

These inputs let you connect either other audio sources, or the Malström’s own internal signal directly to the filters and the shaper - see “Routing external audio to the filters”.

## Sequencer Control

The Sequencer Control CV and Gate inputs allow you to play the Malström from another CV/Gate device (typically a Matrix or a Redrum). The signal to the CV input controls the note pitch, while the signal to the Gate input delivers note on/off along with velocity.

! **For best results, you should use the Sequencer Control inputs with monophonic sounds.**

## Gate Input

These inputs can receive a CV signal to trigger the following envelopes:

- **Amp Envelope**
- **Filter Envelope**

! **Note that connecting to these inputs will override the normal triggering of the envelopes. For example, if you connected a Modulation output to the Gate Amp in-put, you would not trigger the amp envelope by playing notes, as this is now controlled by the Modulator. In addition you would only hear the Modulator triggering the envelope for the notes that you hold down.**

## Modulation Input

These control voltage (CV) inputs (with associated voltage trim pots and A/B selector switches), can modulate various Malström parameters from other devices, or from the modulation outputs of the same Malström device. These inputs can control the following parameters:

- **Oscillator Pitch**
- **Filter Frequency**
- **Oscillator Index offset**
- **Oscillator Shift**
- **Amp Level**
- **Mod Amount**
- **Mod Wheel**

## Modulation Output

The Modulation outputs can be used to voltage control other devices, or other parameters in the same Malström device.

The Modulation Outputs are:

- **Mod:A**
- **Mod:B**
- **Filter Envelope**

# Routing external audio to the filters

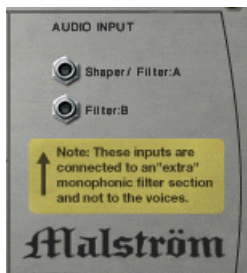

The audio inputs on the back of the Malström allows you to connect any audio signal to the filters and Shaper.

To use this feature, it's important to understand the following background:

Normally the Malström behaves like any regular polyphonic synthesizer, in that each voice has its own filter. The filter settings are the same, but each filter envelope is triggered individually when you play a note.

However, when you connect a signal to the audio inputs, it is routed to an “extra” filter. The envelope for this filter is triggered each time any of the other filter envelopes is triggered. In other words, the “extra” filter envelope is triggered each time you play a note on the Malström.

There are two different uses for the audio inputs:

## Connecting an external signal source

Connecting an audio signal from another device in the rack to the audio input allows you to process the signal through the filters and/or Shaper of the Malström. The processed signal will then be mixed with the Malström's “own” voices (if activated) and sent to the outputs.

The result depends on the following:

- **To which jack you connect the signal.**
- **Whether the filters and/or Shaper are activated on the front panel.**
- **The routing button for filter:B.**

If this is activated and you connect a signal to the Filter:B input, the signal will be processed in filter:B and then sent to the Shaper and filter:A (just as when routing Malström's own oscillators on the front panel).

Note again that the filter envelope is triggered by all voices. To make use of the filter envelope, you either need to play the Malström or use gate signals to trigger it or the filter envelope, separately.

## Connecting the signals from the Malström itself

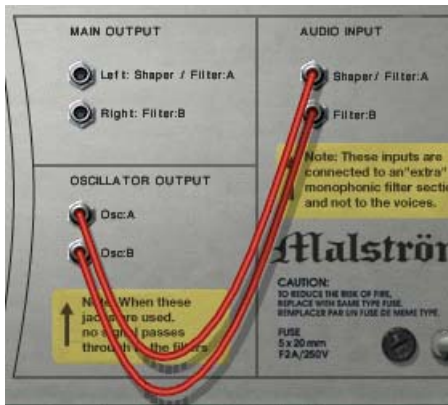

If you connect one or both oscillator outputs to the audio input(s), the internal signal path from the oscillators to the filters is broken. In other words, no signals will pass internally from the oscillators to the filters, and the three routing buttons for the oscillators are ignored.

This may seem pointless at first, but there are several uses for this:

- **When you play the Malström in this mode, the filter envelope will be triggered for each note you play, affecting all sounding notes.**  
This is due to the monophonic “extra” filter described above. On older synthesizers, this feature is called “Multiple triggering”.
- **Since all notes you play are mixed before being sent into the filter, the result of using the Shaper will be totally different (if you play more than one note at a time).**  
This is similar to playing a guitar chord through a distortion effect, for example.
- **You can patch in external effects between the oscillators and the filters.**  
Just connect an oscillator output to the input of the effect device, and the effect output to the Malström's audio input.
- **You can use combinations of connections and routing. You could for instance connect an external audio signal to one of the inputs, one of the Malström's oscillators to the other input and then use the routing options on the front panel for the other oscillator. All of these signals will then be mixed and sent to the Malström's main outputs.**



**Chapter 32**  
**NN-19 Sampler**

# Introduction

A sampler could be described as a device capable of recording and reproducing audio material, like a tape recorder. Unlike a tape or hard disk based recorder, samplers allows you to “play” the recorded sound via MIDI, using a keyboard for example. This way, any reproducible sound can be integrated into the MIDI environment, and be controlled from sequencers etc. like synthesizers.

The NN-19 is a sampler capable of recording and reproducing - but not editing - sound files.

The program comes with numerous ready-made sample patches, covering all kinds of instrument types. In addition to this there are plenty of single samples that can be used for creating your own patches.

If you want to sample and edit your own sounds, you can use the Sampling function, described in the [“Sampling”](#) chapter.

There are also plenty of relatively inexpensive (and even free) audio editing software for both the Windows and the Mac OS X platforms, that will allow you to both record audio (via your computers or audio cards audio inputs), and to edit the resulting audio file. Virtually every software that is capable of this, can create sound files which can be loaded directly into the NN-19.

Also, there are thousands of high quality sample libraries available, covering every conceivable musical style or direction ranging from professionally recorded orchestral samples to esoteric electronic noises.

## General sampling principles

### Background

Before a sound can be used by a sampler, it must be converted to a digital signal. Hardware samplers and computer audio cards provide audio inputs that can convert the analog signal to digital, by the use of an “A/D Converter” (analog to digital). This “samples” the signal at very short time intervals and converts it to a digital representation of the analog signal's waveform. The sample rate and the bit depth of this conversion determines the resulting sound quality. Finally the signal is passed through a digital to analog converter (D/A) which reconstructs the digital signal back to analog, which can be played back.

### Multisampling vs. single samples

Most of the included NN-19 patches are made up of a collection of several samples. This is because a single sampled sound only sounds natural within a fairly narrow frequency range. If a single sample is loaded into an empty NN-19, the sample will be playable across the whole keyboard. The pitch (frequency) of the original sample (called root-key) will be automatically placed on the middle C key (C3).

Note that this has nothing to do with the actual pitch the sample itself produces! It may not even have a pitch as such, it could be the sound of someone talking for example.

If you play any single sample about two octaves above or below its root key, it will most likely sound very “unnatural”. In the case of it actually being a sample of someone talking, playing two octaves up will make the talking voice sample sound squeaky, short and most likely unintelligible. Two octaves down the voice will sound something like a drawn-out gargle.

Thus, the range that most samples can be transposed without sounding unnatural is limited. To make a sampled piano, for example, sound good across the whole keyboard, you need to first have made many samples at close intervals across the keyboard, and then define an upper and lower range for each sample, called a Key Zone. All the keyzones in the piano sample patch then make up a Key Map.

How to create key zones is described in [“About Key Zones and samples”](#).

To sample real instruments accurately requires a lot of hard work. Firstly, you need the original instrument, which should be in perfect working order. For acoustic instruments you need a couple of good microphones, a mixer or other device with high quality microphone preamps, and a room with good acoustics. You need to be meticulous when recording the different samples, so that levels are smooth and even across the range etc.

Fortunately Reason provides a wide range of high quality multisampled instruments, so much of this hard work has already been done for you.

In our experience, most people don't use samplers only for playing sampled versions of "real" instruments. Very often, single "stand alone" or single samples are used. Maybe you wish to use different sounds for every key zone. Or you could have complete chorus and verse vocals plus variations assigned to several "one note" key zones. Or use samples of different chords that play rhythmic figures to the same tempo, and use these to build song structures etc. The possibilities are endless. When you use samples in this way, the keys on your keyboard that play the samples do not necessarily correspond to pitch at all, the keys are simply used to trigger the samples.

## About audio file formats

The audio file format support differs depending on which computer OS you are using.

The NN-19 can read audio files in the following formats:

- **In Windows 7:**  
.wav, .aif, .mp3, .aac, .m4a and .wma.
- **In Mac OSX 10.7:**  
.wav, .aiff, .3g2, .3gp, .mp1, .mp2, .mp3, .mpeg, .mpa, .snd, .au, .sd2, .ac3, .aac, .adts, .amr, .caf, .m4a .m4r and .mp4.
- **SoundFonts (.sf2)**  
SoundFonts are an open standard for wavetable synthesized audio, developed by E-mu systems and Creative Technologies.
- **REX file slices (.rx2, .rex, .rcy)**  
REX files are music loops created in the ReCycle program or when editing audio clips inline in Reason (see "Bounce Clip to REX Loop"). The NN-19 lets you either load REX files as patches or separate slices from REX files as individual samples.
- **Any sample rate and practically any bit depth.**

## About the Sample Patch format

Reason's Sample Patch format (.smp), is based on either Wave or AIFF files, but includes all the NN-19 associated parameter settings as well.

- **The audio files may be stereo or mono. Stereo audio files are shown with a "S" symbol beside its name in the display.**

## Loading a Sample Patch

When you create a new NN-19 device, it is automatically loaded with a default patch. If you want to start from scratch, with no samples loaded, you can select "Reset Device" from the context menu or Edit menu. For NN-19 to produce sound, you need to load either a sample patch, or a sample - or sample a sound yourself using the Sampling function (see "Sampling").

A patch contains "everything". All the samples, assigned key zones, and associated panel settings will be loaded. Loading a sample patch is done using the Browser, just like in all other devices that use Patches.

1. **Click the Browse Patch button on the front panel to set browse focus to the NN-19 device.**
  2. **Navigate to the folder that contains the NN-19 patch you wish to load, select it and click Load in the Browser.**
- **Alternatively, drag an NN-19 patch from the Browser and drop it on the NN-19 device in the rack.**  
The panel is dimmed in orange and the Patch Replace symbol appears in the center.

## Loading REX Files as Patches

REX files are music loops created in the ReCycle program or when editing audio clips inline in Reason (see [“Bounce Clip to REX Loop”](#)). In Reason, REX files are primarily used in the Dr. Octo Rex loop player, but they can be used in the NN-19 as well. Possible extensions are “.rx2”, “.rcy” and “.rex”.

1. **Click the Browse Patch button on the front panel to set browse focus to the NN-19 device.**
  2. **Navigate to the folder that contains the REX loop you wish to load, select it and click Load in the Browser.**
- **Alternatively, drag a REX loop from the Browser and drop it on the NN-19 device in the rack.**  
The panel is dimmed in orange and the Patch Replace symbol appears in the center.

When loading a REX file, each slice in the file is assigned to one key, chromatically, starting from C1. All parameters are set to their default settings.

When using REX files in the Dr. Octo Rex loop player, it is possible to make a track play the slices in order to recreate the original loop. To do the same in the NN-19 requires a few extra steps.

1. **Use the Browser to load the REX file into an NN-19 sampler.**
2. **Create a Dr. Octo Rex loop player and load the same REX file into a Loop Slot of this device.**
3. **Use the “Copy Loop To Track” feature on the Dr. Octo Rex to create playback data (a group) on the track assigned to the Dr. Octo Rex.**
4. **Move that group to the track that plays the NN-19 and play it back from there.**
5. **Delete the Dr. Octo Rex loop player.**

## Sampling in NN-19

The sampling procedure is generic for all Reason devices that can sample (NN-19, NN-XT, Redrum and Kong). The sampling and sample editing procedures are described in detail in the [“Sampling”](#) chapter.

- **To sample your own sound and automatically load it into the NN-19 device, click the Sample button.**



Refer to the [“Sampling”](#) chapter for details on how to set up and use the sampling feature.

# About Key Zones and samples

## Loading a Sample into an empty NN-19

1. Create an NN-19 device and select “Reset Device” from the context menu or from the Edit menu.

2. Click on the Browse Sample button.

This is located above the keyboard display to the left.



→ When you browse samples, you can preview them before loading using the Play button in the Browser. If you select the “Autoplay” function, the samples play back once automatically when selected.

3. Select a sample in the Browser and click the Load button in the Browser to load it.

→ Alternatively, drag a sample file from the Browser and drop it on the NN-19 device in the rack.

The panel is dimmed in blue and a Sample Replace symbol appears in the center.

When you load the first sample into an empty NN-19, this will be assigned a key zone that spans the entire range of the keyboard, and the default Init Patch settings will be used.

Below the keyboard, the range, sample name, root key, tuning, level and loop status of the current key zone is displayed, each with a corresponding knob.



The light blue strip above the keyboard indicates the currently selected key zone, which is in this case the full range of the keyboard.

The inverted note on the keyboard indicates the “root key” of the sample. All samples contain a root key, tuning and level setting. If NN-19 is empty, a sample will have its root key placed on the middle “C” (C3) key.

4. If desired, click on the keyboard to change the root key.

! You can audition a loaded sample patch or sample by holding down [Option] (Mac)/[Alt] (Windows) and clicking on a key in the Keyboard display. The mouse will take on the shape of a speaker symbol to indicate this.

## Loading SoundFont samples

The SoundFont format was developed by E-mu systems in collaboration with Creative Technologies. It is a standardized data format containing wavetable synthesized audio and information on how it should be played back in wavetable synthesizers - typically on audio cards. The SoundFont format is an open standard so there is a vast amount of SoundFont banks and SoundFont compatible banks developed by third parties.

The samples in a SoundFont are stored hierarchically in different categories: User Samples, Instruments, Presets etc. The NN-19 allows you to browse for and load single SoundFont samples, but *not* entire soundfonts.

**1. Click the Browse Sample button, select a SoundFont file (.sf2) in the Browser and open it.**

The Browser opens the SoundFont and displays the folders within it.

**2. Select the folder “Samples” and open it.**

This folder contains a number of samples which can be loaded like any other sample.

**3. Select the desired sample and load it by clicking the Load button in the Browser.**

The sample is loaded and assigned a key zone range that spans the entire keyboard. You can now make settings for it as with any other sample.

→ **Alternatively, drag a sample file from the Browser and drop it on the NN-19 device in the rack.**

The panel is dimmed in blue and a Sample Replace symbol appears in the center.

## Loading REX slices as samples

A slice is a snippet of sound in a REX File.

**1. To import a REX slice, click the Browse Sample button (see above), browse to a REX file and open it as if it was a folder.**

The Browser will then display the slices as files inside that “folder”.

**2. Select the desired REX slice and load it by clicking the Load button in the Browser.**

The REX slice is loaded and assigned a key zone range that spans the entire keyboard. You can now make settings for it as with any other sample.

→ **Alternatively, drag REX slice from the Browser and drop it on the NN-19 device in the rack.**

The panel is dimmed in blue and a Sample Replace symbol appears in the center.

In the rest of this manual, when we refer to importing samples, all that is said applies to REX slices as well.

## Creating Key Zones

A “key zone” is a range of keys, that plays a sample. All key zones together make up a “key map”.

To create a new key zone, the following methods can be used:

→ **Select “Split Key Zone” from the Edit or context menus.**

This splits the currently selected key zone in the middle. The new zone is the upper half of the split, and is empty. The dividing point has a “handle” above it, see “Setting the Key Zone Range” below for a description.

- **By [Alt]/[Option]-clicking at a point just above the key zone strip, a new empty key zone is created.**

The point where you click becomes the lower limit (or boundary) for the original key zone, and the upper limit for the new key zone.



*The new empty key zone gets selected upon creation.*

## Selecting Key Zones

Only one key zone can be selected at a time. A selected key zone is indicated by a light blue (as opposed to dark blue) strip above the keyboard in the display. There are two ways you can select key zones:

- **By clicking on a non-selected key zone in the display.**
- **By activating the “Select Key Zone via MIDI” button.**

Playing a note belonging to a non-selected key zone from your MIDI keyboard, will select the key zone it belongs to.

## Setting the Key Zone Range

- ! **Key zones cannot overlap.**

When you adjust the boundaries of a key zone, the surrounding boundaries are automatically adjusted accordingly. You can change the key zone range in the following ways:

- **By dragging the “handle(s)” which divides the key zones, you can change the range of the selected key zone.**  
In the case of having two key zones split in the middle, you could thus change the lower limit for the upper (new) key zone and the upper limit for the original key zone.



→ By using the “Lowkey” and “Highkey” knobs to set a lower and upper range, respectively.



## Deleting a Key Zone

→ To delete a key zone, select it and then select “Delete Key Zone” from the Edit menu.

## About Key zones, assigned and unassigned samples

When you load samples and rearrange your key mapping, you will often end up with samples that are not assigned to any key zone. In the following texts we refer to the samples as follows:

- **Assigned samples** are samples that are currently assigned to one or more key zones.
- **Unassigned samples** are samples that reside in the sample memory, but that are currently not assigned to any key zone.

## Adding sample(s) to a Key Map

### If the sample hasn't been loaded yet

**1. Select a key zone.**

This can be empty, or contain a sample - it doesn't matter for now.

**2. Use the Browser to add one, or several (see below), sample(s).**

The following will happen:

- If the zone contained a sample prior to loading, this will be *replaced*, both in the zone and in the sample memory, unless the sample was also used by *another* key zone, in which case it will be kept.
- If you loaded several samples, one of the samples will be assigned to the key zone, and the other samples will be loaded but remain unassigned.

### If the sample is already loaded but unassigned

**1. Select a key zone.**

This can be empty, or contain a sample - it doesn't matter for now.



## 2. Use the Sample knob to dial in the sample you want the key zone to play.



The Sample knob.

## Setting the Root Key

Once you have defined a key zone, and added a sample, you should set the root key for the sample.

- **Select the key zone the sample belongs to, and click on the key you wish to set the root key to.**  
Which key to select is normally determined by the pitch of the sample. For example if the sample plays a F#2 guitar note, click on F#2.
- **Note that it is possible to select a root key outside the key zone, if required.**

## Removing sample(s) from a Key Map

- **To remove a sample, select the zone it belongs to, and then select “Delete Sample” from the Edit or context menus.**  
The sample is removed from the zone and from sample memory.
- **To remove a sample from a key zone/map, *without* removing it from memory, you can either select “No Sample” with the Sample knob for that zone, or simply replace it with another sample in the same way.**

## Removing all unassigned samples

- **To remove all samples that are not assigned to any key zone, select Delete Unused Samples from the Edit menu.**

## Rearranging samples in a Key Map

There is no specific function for rearranging or trading places between samples and key zones. Simply select a key zone and change the current sample assignment with the Sample knob.

## Setting Sample Level

For each key zone you can set a volume level, using the Level button below the display. If the transition between two key zones causes a noticeable level difference, this parameter can be used to balance the levels.

## Tuning samples

Sometimes you might find that the samples you wish to use in a key map are slightly out of tune with *each other*. This parameter allows you to tune each sample in a map by +/- half a semitone.

- **Select the key zone(s) that contains the out of tune sample(s), and use the Tune knob below the keyboard display.**

- If all samples originate from different sources, and all or most of them are pitched slightly different (a not uncommon sampling scenario), you could first tune them so that they all match each other, and then, if necessary, use the Sample Pitch controls in the Osc section to tune them globally to the “song” you wish to use the samples in.
- Note that if all the samples were slightly out of tune *by the same amount* in relation to the song you intend to use the samples in, it would be much simpler to use the Sample Pitch controls in the Osc section directly.

## Looping Samples



A sample, unlike the cycles of an oscillator for example, is a finite quantity. There is a sample start and end. To get samples to play for as long as you press down the keys on your keyboard, they need to be *looped*.

For this to work properly, you have to first set up two loop points which determine the part of the sample that will be looped, and make this a part of the audio file. You cannot set loop points in the NN-19, this has to be done in the Edit Sample window (see “[Looping samples](#)”) or in an external sample editor.

All included samples already have set loop points (if needed).

For each sample (or key zone), you can select the following Loop modes by using the Loop knob below the keyboard display:

- **OFF**  
No looping is applied to the sample.
- **FWD**  
The part between the loop points plays from start to end, then the cycle is repeated. This is the most common loop mode.
- **FWD - BW**  
The part between the loop points plays from start to end, then from end to start, and then repeats the cycle.
- ! **For samples without any loop points, the whole sample will be looped.**

## About the Solo Sample function

The Solo Sample button will allow you to listen to a selected sample over the entire keyboard range.

- **Select the key zone the sample is assigned to, and then activate Solo Sample.**  
This can be useful for checking if the root key is set correctly or if the current range is possible to extend etc.
- ! **For Solo Sample to work, “Select Key Zone via MIDI” must be disabled!**

# Automap Samples

If you have a number of samples that belong together, but haven't mapped them to key zones you can use the "Automap Samples" function on the Edit menu. This is used in the following way:

**1. Select all samples that belong together and load them in one go, using the sample browser.**

One of the samples will be assigned to a key zone spanning the whole range, and the rest will be loaded in to memory but remain unassigned.

**2. Select Automap Samples from the Edit menu.**

Now all samples currently in memory (assigned or unassigned) will be arranged automatically so that:

→ **Each sample will be placed correctly according to its root note, and will be tuned according to the information in the sample file.**

Most audio editing programs can save root key information as part of the file.

→ **Each sample will occupy half the note range to the next sample's root note.**

The root key will always be in the middle of each zone, with the zone extending both down and up in relation to the root position.

## Mapping samples without Root Key or Tuning information

Some samples may not have any information about root key or tuning stored in the file. If the file names indicate the root key you can manually set it for each sample using the method described below. In a worst case scenario, i.e. no tuning or root key information whatsoever, you can still make use of the Automap function:

**1. Select all samples that belong together and load them in one go, using the sample browser.**

One of the samples will be assigned to a key zone spanning the whole range, and the rest will be loaded in to memory but remain unassigned.

**2. Manually set the root key, and adjust the tune knob if the sample needs fine-tuning.**

Without any information stored in the file, or if the file name doesn't indicate the root key, you will have to use your ears for this step. Play the sample and use another instrument or a tuner to determine its pitch.

**3. Select the next sample using the Sample knob, and repeat the previous step.**

Proceed like this until you have set a root key for all the samples in memory.

**4. Select "Automap Samples" from the edit menu.**

The samples will be mapped according to their set root key positions!

## How Mapping Information is saved

All information about key zones, high and low range, root key etc. is stored as part of the Sampler Patch. The original sample files are never altered!

# NN-19 synth parameters

The NN-19 synth parameters are used to shape and modulate samples. These are mostly similar to the parameters used to shape the oscillators in Subtractor - you have envelope generators, a filter, velocity control etc. Again, it is important to remember that these parameters do not alter the audio files in any way, only the way they will play back.

! **These parameters are global, in the sense that they will affect all samples in a sample patch.**

## The Oscillator Section



For a sample patch, the actual samples are what oscillators are for a synthesizer, the main sound *source*. The following settings can be made in the Osc section of the NN-19:

### Sample Start

This changes the start position of samples in a sample patch. Turning the knob clockwise gradually offsets the samples' start position, so that they will play back from a position further "into" the samples' waveform. This is useful mainly for two things:

- **Removing "air" or other unwanted artefacts from the start of less than perfect samples.**  
Occasionally (although not in any samples supplied with Reason) you may come across samples where the start point of the sample is slightly ahead of the start of the actual sound. There may be noise or silence in the beginning which was not intended to be part of the sample. By adjusting the sample start position, this can be removed.
- **Changing the start point as an effect.**  
For example, if you had a sample of someone saying "one, two, three", you could change the start position so that when you played the sample it would start on "three".
- **You can also assign velocity sample start allowing to use your playing to determine the exact sample start. See later in this chapter.**

### Setting Sample Pitch - Octave/Semitone/Fine

By adjusting the corresponding knobs you can change the pitch of all samples belonging to a patch, in three ways:

- **Octave steps**  
The range is 0 - 8. The default setting is 4.
- **Semitone steps**  
Allows you to raise the frequency in 12 semitone steps (1 octave).
- **Fine steps (100th of a semitone)**  
The range is -50 to 50 (down or up half a semitone).

! **Note that the controls in this section cannot be used to tune samples against each other, as all samples will be affected equally. To tune individual samples, you use the Tune parameter below the keyboard display (see “Tuning samples”).**

## Keyboard Tracking

The Osc section has a button named “Kbd. Track”. If this is switched off, the sample's pitch will remain constant, regardless of any incoming note pitch messages, although the oscillator still reacts to note on/off messages. This could be useful if you are using non-pitched samples, like drums for example. You could then play a sample in a zone using several keys, allowing for faster note triggering if you wanted to play a drum roll, for example.

## Osc Envelope Amount

This parameter determines to what degree the overall pitch of the samples will be affected by the Filter Envelope (see “Filter Envelope”). You can set negative or positive values here, which determines whether an envelope parameter should raise or lower the pitch.

## The Filter Section



Filters are used for shaping the overall timbre of the sound. The filter in NN-19 is a multimode filter with five filter types.

### Filter Mode

With this selector you can set the filter to operate as one of five different types of filter. These are as follows:

- **24 dB Lowpass (LP 24)**  
Lowpass filters let low frequencies pass and cut out the high frequencies. This filter type has a fairly steep roll-off curve (24dB/Octave). Many classic synthesizers (Minimoog/Prophet 5 etc.) used this filter type.
- **12 dB Lowpass (LP 12)**  
This type of lowpass filter is also widely used in classic analog synthesizers (Oberheim, TB-303 etc.). It has a gentler slope (12 dB/Octave), leaving more of the harmonics in the filtered sound compared to the LP 24 filter.
- **Bandpass (BP 12)**  
A bandpass filter cuts both high and low frequencies, while midrange frequencies are not affected. Each slope in this filter type has a 12 dB/Octave roll-off.
- **High-Pass (HP12)**  
A highpass filter is the opposite of a lowpass filter, cutting out the lower frequencies and letting the high frequencies pass. The HP filter slope has a 12 dB/Octave roll-off.
- **Notch**  
A notch filter (or band reject filter) could be described as the opposite of a bandpass filter. It cuts off frequencies in a narrow midrange band, letting the frequencies below and above through.

## Filter Frequency

The Filter Frequency parameter (often referred to as “cutoff”) determines which area of the frequency spectrum the filter will operate in. For a lowpass filter, the frequency parameter could be described as governing the “opening” and “closing” of the filter. If the Filter Freq is set to zero, none or only the very lowest frequencies are heard, if set to maximum, all frequencies in the waveform are heard. Gradually changing the Filter Frequency produces the classic synthesizer filter “sweep” sound.

! **Note that the Filter Frequency parameter is usually controlled by the Filter Envelope (see “Envelope Section” below) as well. Changing the Filter Frequency with the Freq slider may therefore not produce the expected result.**

## Resonance

The filter resonance parameter (sometimes called Q) is used to set the Filter characteristic, or quality. For lowpass filters, raising the filter Res value will emphasize the frequencies around the set filter frequency. This produces a generally thinner sound, but with a sharper, more pronounced filter frequency “sweep”. The higher the resonance value, the more resonant the sound becomes until it produces a whistling or ringing sound. If you set a high value for the Res parameter and then vary the filter frequency, this will produce a very distinct sweep, with the ringing sound being very evident at certain frequencies.

- **For the highpass filter, the Res parameter operates just like for the lowpass filters.**
- **When you use the Bandpass or Notch filter, the Resonance setting adjusts the width of the band. When you raise the Resonance, the band where frequencies are let through (Bandpass), or cut (Notch) will become narrower. Generally, the Notch filter produces more musical results using low resonance settings.**

## Envelope Section

Envelope generators are used to control several important sound parameters in analog synthesizers, such as pitch, volume, filter frequency etc. Envelopes govern how these parameters should respond over time - from the moment a note is struck to the moment it is released.

Standard synthesizer envelope generators have four parameters; Attack, Decay, Sustain and Release (ADSR).

There are two envelope generators in the NN-19, one for volume, and one for the filter frequency.

! **Please refer to the Subtractor chapter for a description of the basic envelope parameters.**

## Amplitude Envelope

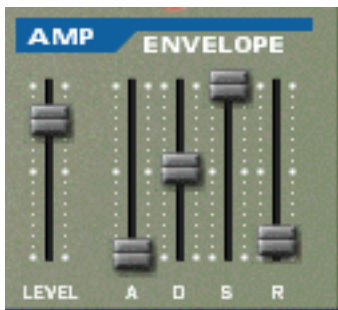

The Amp Envelope is used to adjust how the volume of the sound should change from the time you press a key until the key is released. By setting up a volume envelope you sculpt the sound's basic shape with the four Amplitude Envelope parameters, Attack, Decay, Sustain and Release. This determines the basic character of the sound (soft, long, short etc.). The Level parameter acts as a general volume control for the sample patch.

## Filter Envelope

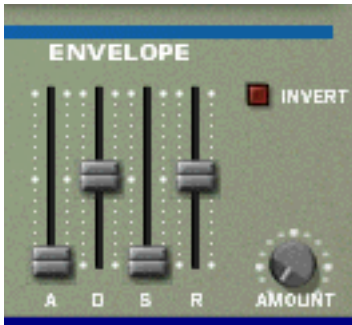

The Filter Envelope can be used to control two parameters; filter frequency and sample pitch. By setting up a filter envelope you control the how the filter frequency and/or the sample pitch should change over time with the four Filter Envelope parameters, Attack, Decay, Sustain and Release.

## Filter Envelope Amount

This parameter determines to what degree the filter will be affected by the Filter Envelope. Raising this knob's value creates more drastic results. The Envelope Amount parameter and the set filter frequency are related. If the Filter Freq slider is set to around the middle, this means that the moment you press a key the filter is already halfway open. The set Filter Envelope will then open the filter further from this point. The Filter Envelope Amount setting affects how much further the filter will open.

## Filter Envelope Invert

If this button is activated, the envelope will be inverted. For example, normally the Decay parameter lowers the filter frequency, but after activating Invert it will instead raise it, by the same amount. Note that Invert does not affect the Osc pitch parameter (this can be inverted by setting positive or negative values).

## LFO Section



LFO stands for Low Frequency Oscillator. LFOs are oscillators in the sense that they generate a waveform and a frequency. However, there are two significant differences compared to normal sound generating oscillators:

- **LFOs only generate waveforms with low frequencies.**
- **The output of the two LFOs are never actually heard. Instead they are used for modulating various parameters.**

The most typical application of an LFO is to modulate the pitch of a (sound generating) oscillator or sample, to produce vibrato.

The LFO section has the following parameters:

## Waveform

LFO 1 allows you to select different waveforms for modulating parameters. These are (from the top down):



Waveform	Description
Triangle	This is a smooth waveform, suitable for normal vibrato.
Inverted Sawtooth	This produces a "ramp up" cycle. If applied to an oscillator's frequency, the pitch would sweep up to a set point (governed by the Amount setting), after which the cycle immediately starts over.
Sawtooth	This produces a "ramp down" cycle, the same as above but inverted.
Square	This produces cycles that abruptly changes between two values, usable for trills etc.
Random	Produces random stepped modulation to the destination. Some vintage analog synths called this feature "sample & hold".
Soft Random	The same as above, but with smooth modulation.

## Destination

The available LFO Destinations are as follows:

Destination	Description
Osc	Selecting this makes LFO control the pitch (frequency) of the sample patch.
Filter	Selecting this makes the LFO control the filter frequency.
Pan	Selecting this makes the LFO modulate the pan position of samples, i.e. it will move the sound from left to right in the stereo field.

## Sync

By clicking this button you activate/deactivate LFO sync. The frequency of the LFO will then be synchronized to the song tempo, in one of 16 possible time divisions. When sync is activated, the Rate knob (see below) is used for setting the desired time division.

Turn the knob and check the tooltip for an indication of the time division.



## Rate

The Rate knob controls the LFO's frequency. Turn clockwise for a faster modulation rate.

## Amount

This parameter determines to what degree the selected parameter destination will be affected by the LFO. Raising this knob's value creates more drastic results.



# Play Parameters

This section deals with two things: Parameters that are affected by how you play, and modulation that can be applied manually with standard MIDI keyboard controls.

These are:

- **Velocity Control**
- **Pitch Bend and Modulation Wheel**
- **Legato**
- **Portamento**
- **Polyphony**
- **Voice Spread**
- **External Controllers**

## Velocity Control



Velocity is used to control various parameters according to how hard or soft you play notes on your keyboard. A common application of velocity is to make sounds brighter and louder if you strike the key harder. By using the knobs in this section, you can control how much the various parameters will be affected by velocity. The velocity sensitivity amount can be set to either positive or negative values, with the center position representing no velocity control.

The following parameters can be velocity controlled:

Destination	Description
Amp	This lets you velocity control the overall volume of the sound. If a positive value is set, the volume will increase the harder you strike a key. A negative value inverts this relationship, so that the volume decreases if you play harder, and increases if you play softer. If set to zero, the sound will play at a constant volume, regardless of how hard or soft you play.
F. Env	This sets velocity control for the Filter Envelope Amount parameter. A positive value will increase the envelope amount the harder you play. Negative values invert this relationship.
F. Dec	This sets velocity control for the Filter Envelope Decay parameter. A positive value will increase the Decay time the harder you play. Negative values invert this relationship.
S.Start	This sets velocity control for the Sample Start parameter. A positive value will increase the Start Time amount the harder you play. Negative values invert this relationship.
A. Attack	This sets velocity control for the Amp Envelope Attack parameter. A positive value will increase the Attack time the harder you play. Negative values invert this relationship.

## Pitch Bend and Modulation Wheels

The Pitch Bend wheel is used for “bending” notes, like bending the strings on a guitar. The Modulation wheel can be used to apply various modulation while you are playing. Virtually all MIDI keyboards have Pitch Bend and Modulation controls. NN-19 also has two functional wheels that could be used to apply real time modulation and pitch bend should you not have these controllers on your keyboard, or if you aren’t using a keyboard at all. The wheels mirror the movements of the MIDI keyboard controllers.

## Pitch Bend Range

The Range parameter sets the amount of pitch bend when the wheel is turned fully up or down. The maximum range is "24" (=up/down 2 Octaves).

## Modulation Wheel

The Modulation wheel can be set to simultaneously control a number of parameters. You can set positive or negative values, just like in the Velocity Control section. The following parameters can be affected by the modulation wheel:

Destination	Description
F. Freq	This sets modulation wheel control of the Filter Frequency parameter. A positive value will increase the frequency if the wheel is pushed forward. Negative values invert this relationship.
F. Res	This sets modulation wheel control of the Filter Resonance parameter. A positive value will increase the resonance if the wheel is pushed forward. Negative values invert this relationship.
F. Dec	This sets modulation wheel control for the Filter Envelope Decay parameter. A positive value will increase the decay if the wheel is pushed forward. Negative values invert this relationship.
LFO	This sets modulation wheel control of the LFO Amount parameter. A positive value will increase the Amount if the wheel is pushed forward. Negative values invert this relationship.
Amp	This sets modulation wheel control for the Amp level parameter. A positive value will increase the level if the wheel is pushed forward. Negative values invert this relationship.

## Legato

Legato works best with monophonic sounds. Set Polyphony (see ["Setting Number of Voices - Polyphony"](#)) to 1 and try the following:

→ **Hold down a key and then press another key without releasing the previous.**

Notice that the pitch changes, but the envelopes do not start over. That is, there will be no new "attack".

→ **If polyphony is set to more voices than 1, Legato will only be applied when all the assigned voices are "used up".**

For example, if you had a polyphony setting of "4" and you held down a 4 note chord, the next note you played would be Legato. Note, however, that this Legato voice will "steal" one of the voices in the 4 note chord, as all the assigned voices were already used up!

## Retrig

This is the "normal" setting for playing polyphonic patches. That is, when you press a key without releasing the previous, the envelopes are retriggered, like when you release all keys and then press a new one. In monophonic mode, Retrig has an additional function; if you press a key, hold it, press a new key and then release that, the first note is also retriggered.

## Portamento (Time)

Portamento is when the pitch "glides" between the notes you play, instead of instantly changing the pitch. The Portamento knob is used to set how long it takes for the pitch to glide from one pitch to the next. If you don't want any Portamento at all, set this knob to zero.

## Setting Number of Voices - Polyphony

This determines the polyphony, i.e. the number of voices a patch can play simultaneously. This can be used to make a patch monophonic (=a setting of "1"), or to extend the number of voices available for a patch. The maximum number of voices you can set a patch to use is 99.

**! Note that the Polyphony setting does not "hog" voices. For example, if you have a patch that has a polyphony setting of ten voices, but the part the patch plays only uses four voices, this won't mean that you are "wasting" six voices. In other words, the polyphony setting is not something you need to consider if you want to conserve CPU power - it is only the number of voices *actually used* that counts.**

## Voice Spread

This parameter can be used to control the stereo (pan) position of voices. The Spread knob determines the intensity of the panning. If this is set to "0", no panning will take place. The following pan modes can be selected:

Mode	Description
Key	This will shift the pan position gradually from left to right the higher up on the keyboard you play.
Key 2	This will shift the pan position from left to right in 8 steps (1/2 octave) for each consecutive higher note you play, and then repeat the cycle.
Jump	This will alternate the pan position from left to right for each note played.

## Low Bandwidth

This will remove some high frequency content from the sound, but often this is not noticeable (this is especially true if you have "filtered down" samples). Activating this mode will save you some extra computer power, if needed.

## Controller Section

NN-19 can receive common MIDI controller messages, and route these to various parameters. The following MIDI messages can be received:

- **Aftertouch (Channel Pressure)**
- **Expression Pedal**
- **Breath Control**

If your MIDI keyboard is capable of sending Aftertouch messages, or if you have access to an Expression Pedal or a Breath controller, you can use these to modulate NN-19 parameters. The "Source" selector switch determines which of these message-types should be received.

These messages can then be assigned to control the following parameters:

F. Freq	This sets external modulation control of the filter frequency parameter. A positive value will increase the frequency with higher external modulation values. Negative values invert this relationship.
LFO 1	This sets external modulation control of the LFO Amount parameter. A positive value will increase the LFO amount with higher external modulation values. Negative values invert this relationship.
Amp	This lets you control the overall volume of the sound with external modulation. If a positive value is set, the volume will increase with higher external modulation values. A negative value inverts this relationship.

# Connections

On the back panel of the NN-19 you will find the connectors, which are mostly CV/Gate related.



## Audio Outputs

These are the main left and right audio outputs. When you create a new NN-19 device, these are auto-routed to the first available channel on the audio mixer.

## Mono Sequencer Control

These are the main CV/Gate inputs. CV controls the note pitch. Gate inputs trigger note on/off values plus a level, which can be likened to a velocity value. If you want to control the NN-19 from a Matrix Pattern Sequencer for example, you would normally use these inputs. The inputs are “mono”, i.e. they control one voice in the sampler.

## Modulation Inputs

**! Remember that CV connections will not be stored in the sample patch, even if the connections are to/from the same NN-19 device!**

These control voltage (CV) inputs (with associated voltage trim pots), can modulate various NN-19 parameters from other devices, or from the modulation outputs of the same NN-19 device. These inputs can control the following parameters:

- **Osc (sample) Pitch**
- **Filter Cutoff**
- **Filter Resonance**
- **Amp Level**
- **Mod Wheel**

## Modulation Outputs

The Modulation outputs can be used to voltage control other devices, or other parameters in the same NN-19 device. The Modulation Outputs are:

- **Filter Envelope**
- **LFO**

## Gate Inputs

These inputs can receive a CV signal to trigger the envelopes. Note that connecting to these inputs will override the “normal” triggering of the envelopes. For example, if you connected a LFO output to the Gate Amp input, you would not trigger the amp envelope by playing notes, as this is now controlled by the LFO. In addition you would only hear the LFO triggering the envelope for the notes that you hold down.

- **Amp Envelope**
- **Filter Envelope**



# **Chapter 33**

## **NN-XT Sampler**

# Introduction

The basic functions of the NN-XT are very similar to those of its sampler companion in the Reason rack - the NN-19 (see “[NN-19 Sampler](#)”). Just like the NN-19, NN-XT lets you load samples and create multi-sample patches by mapping samples across the keyboard. The sound can then be modified by a comprehensive set of synth-type parameters. There are however some major differences between the two. The NN-XT has:

→ **Support for SoundFonts.**

Presets and samples from SoundFont banks can be loaded and used in the NN-XT (see “[Loading SoundFonts](#)”).

→ **8 stereo output pairs.**

This makes it possible to route different samples to different mixer channels for individual effect processing (see “[Out](#)”).

→ **The possibility to create layered sounds.**

This is done by mapping several samples across the same keyboard range (see “[Creating layered sounds](#)”).

→ **The possibility to create sounds that only play over certain velocity ranges, velocity switched key maps and velocity crossfading.**

See “[Setting velocity range for a Zone](#)”.

→ **Key maps with individual synth parameter settings for each sample.**

See “[Synth parameters](#)”.

Even though the NN-XT is a more advanced sample player than NN-19, it should not be considered as a successor to the NN-19, but rather as a complement to it. The NN-19 will for example probably still be the sampler of choice for those of you who want to be able to quickly load a couple of samples and start playing, since that particular aspect takes a little more doing with the NN-XT.

## Sampling in NN-XT

The sampling procedure is generic for all devices that can sample (NN-19, NN-XT, Redrum and Kong). The sampling and sample editing procedures are described in detail in the “[Sampling](#)” chapter.

→ **To sample your own sound and automatically load it into the NN-XT device, click the **Sample** button.**



Refer to the “[Sampling](#)” chapter for details on how to set up and use the sampling feature.



# Panel overview

## The main panel

When the NN-XT is added to the rack, you will initially only see the main panel.



The NN-XT main panel.

The main panel is where you load complete sample patches. It also contains the “global controls”. These are controls that affect and modify the sound of entire patches rather than the individual key zones.

## The Remote Editor panel

To show/hide the remote editor panel, use the fold/unfold arrow at the bottom left.



The remote editor panel is where you load individual samples, create key maps, modify the sound of the samples with synth parameters etc.

**! The main panel of the NN-XT can be folded like any other Reason device. Note that folding the main panel will also fold the remote editor regardless of its current state.**

# Loading complete Patches and REX files

As previously alluded, you can load complete sample patches as well as individual samples into the NN-XT.

- **A patch is a complete “sound package”.** It contains information about all the samples used, assigned key zones, associated panel settings etc. Loading a sample patch is done by using the patch browser on the main panel, and works in the same way as with any other Reason device.



*The Browse Patch button on the main panel.*

For general instructions on how to load and save patches, please see [“Loading patches”](#) and [“Saving patches”](#).

- **Loading separate samples is done in a similar way, but via the sample browser on the remote editor panel.** If you load samples, map them across keyboard ranges and set up the sound the way you want it, you can save your settings as a Patch for easy access later.

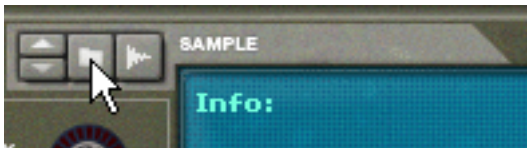

*The Browse Sample button on the remote editor.*

More about loading samples later in this chapter.

## Loading NN-XT Patches

NN-XT Patches are patches made specifically for the NN-XT. Reason ships with a large number of NN-XT Patches, some in the Factory Sound Bank but most in the Orkester Sound Bank. NN-XT Patches have the extension “.sxt”.

1. **Click the Browse Patch button on the front panel to set browse focus to the NN-XT device.**
  2. **Navigate to the folder that contains the NN-XT patch you wish to load, select it and click Load in the Browser.**
- **Alternatively, drag an NN-XT patch from the Browser and drop it on the NN-XT device in the rack.**  
The panel is dimmed in orange and the Patch Replace symbol appears in the center.

## Loading NN-19 Patches

NN-19 Patches have the extension “.smp”. Note that when loading NN-19 patches into the NN-XT, some parameters will not be applicable since the NN-19 and the NN-XT to some extent differ from each other in terms of controls. In these cases, the concerned parameters will either be ignored by the NN-XT or mapped to the most equivalent control.

1. **Click the Browse Patch button on the front panel to set browse focus to the NN-XT device.**
  2. **Navigate to the folder that contains the NN-19 patch you wish to load, select it and click Load in the Browser.**
- **Alternatively, drag an NN-19 patch from the Browser and drop it on the NN-XT device in the rack.**  
The panel is dimmed in orange and the Patch Replace symbol appears in the center.

## Loading SoundFonts

The SoundFont format was developed by E-mu systems in collaboration with Creative Technologies. It is a standardized data format containing wavetable synthesized audio and information on how it should be played back in wavetable synthesizers - typically on audio cards. The SoundFont format is an open standard so there is a vast amount of SoundFont banks and SoundFont compatible banks developed by third parties.

Loading SoundFonts is no different from loading NN-XT Patches. As with NN-19 Patches, the NN-XT does its best to map all the SoundFont settings to NN-XT parameters.

You can load SoundFont presets by using the patch browser, and single SoundFont samples by using the sample browser.

## Loading complete REX files as Patches

REX files are music loops created in the ReCycle program or when editing audio clips inline in Reason (see [“Bounce Clip to REX Loop”](#)). In Reason, REX files are primarily used in the Dr. Octo Rex loop player, but they can be used in the NN-XT as well. Possible extensions are “.rx2”, “.rcy” and “.rex”.

- 1. Click the Browse Patch button on the front panel to set browse focus to the NN-XT device.**
- 2. Navigate to the folder that contains the REX loop you wish to load, select it and click Load in the Browser.**
- **Alternatively, drag a REX loop from the Browser and drop it on the NN-XT device in the rack.**  
The panel is dimmed in orange and the Patch Replace symbol appears in the center.

When loading a REX file, each slice in the file is assigned to one key, chromatically, starting from C1. All parameters are set to their default settings.

When using REX files in the Dr. Octo Rex loop player, it is possible to make a track play the slices in order to recreate the original loop. To do the same in the NN-XT requires a few extra steps.

- 1. Use the Browser to load the REX file into an NN-XT sampler.**
- 2. Create a Dr. Octo Rex loop player and load the same REX file into a Loop Slot of this device.**
- 3. Use the Copy Loop To Track feature on the Dr. Octo Rex to create playback data (a group) on the track assigned to the Dr. Octo Rex.**
- 4. Move that group to the track that plays the NN-XT and play it back from there.**
- 5. Delete the Dr. Octo Rex loop player.**

# Using the main panel

All of the controls on the main panel are used for globally modifying certain parameters for *all* of the samples in a patch, by the same amount.

**! Movements of the parameters on the main panel can be recorded as automation. However, controls on the remote editor panel (described later) can not!**

The following is a description of the controls and parameters on the main panel.

## The Pitch and Modulation wheels



Most MIDI keyboards come equipped with Pitch Bend and Modulation wheels. The NN-XT features settings for how incoming MIDI Pitch Bend and Modulation wheel messages should affect the sound. The wheels on the NN-XT will also mirror the movements of the wheels on your MIDI keyboard.

If you don't have Pitch Bend or Modulation controls on your keyboard, or if you aren't using a keyboard at all, you can use the two fully functional wheels on the NN-XT to apply real time modulation and pitch bend.

- **The Pitch Bend wheel is used for “bending” the played notes up and down to change their pitch - much like bending the strings on a guitar or other string instrument. The Pitch Bend Range is set on the remote editor panel (see “Pitch Bend Range”).**
- **The Modulation wheel can be used for applying modulation to the sound while you’re playing. It can also be used for controlling a number of other parameters, as described in “The Modulation controls”.**

## The External Control wheel



This section can be used in three ways:

### Receiving MIDI controller messages from external sources

NN-XT can receive common MIDI controller messages, and route these to various parameters. You use the “Source” selector switch to determine which type of message should be received:

- **Aftertouch (Channel Pressure)**

- **Expression Pedal**
- **Breath Control**

If your MIDI keyboard is capable of sending aftertouch messages, and/or if you have connected an expression pedal or a breath controller to it, you can use these to modulate NN-XT parameters. Which parameters should be modulated is set in the remote editor panel (see [“The Modulation controls”](#)).

## Recording MIDI controller messages with the wheel

The wheel in the external control section can be used for recording any or all of the three MIDI controller message types into the Reason sequencer. If your MIDI keyboard isn't capable of sending aftertouch messages or you don't have access to an expression pedal or a breath controller, you can use the wheel instead.

This is done just as with any other automation recording, see [“Recording performance controller automation”](#).

## High Quality Interpolation



This switch turns High Quality Interpolation on and off. When it is activated, the sample pitch is calculated using a more advanced interpolation algorithm. This results in better audio quality, especially for samples with a lot of high frequency content.

- **High Quality Interpolation uses more computer power - so if you don't need it, it's a good idea to turn it off! Listen to the sounds in a context and determine whether you think this setting makes any difference.**

## Global Controls



All of these knobs change the values of various parameters in the remote editor panel and affect *all* loaded samples. Thus they can be used for quickly adjusting the overall sound.

The knobs are bi-polar, which means that when they are centered, no parameter change is applied. By turning them to the right you increase the corresponding value, and by turning them to the left, you decrease the value.

Again, the movements of these parameters can be recorded as automation. This is done just as with any other automation recording, see [“Recording parameter automation”](#).

The controls are, from left to right:

## Filter

These two knobs each control a parameter of the filter (see “[The Filter section](#)”). Note that the filter must be on for these to have any effect.

- **Frequency**  
This changes the cutoff frequency of the filter.
- **Resonance**  
This changes the resonance parameter of the filter, meaning - the filter characteristic, or quality.

## Amp Envelope

These three knobs control the Amplitude Envelope (see “[The Amplitude Envelope](#)”) in the following way:

- **Attack**  
This changes the Attack value of the Amplitude Envelope. That is, how long it should take for the sound to reach full level after you press a key on your keyboard.
- **Decay**  
This changes the Decay value of the Amplitude Envelope. Decay determines how long it should take for the sound to go back to the sustain level after it has reached full value (see “[The Amplitude Envelope](#)”) and the key that triggered the sound is still being pressed.
- **Release**  
This changes the Release value of the Amplitude Envelope. Release works just like Decay with the exception that it determines how long it should take for the sound to become silent after the key has been *released*.

## Mod Envelope

This knob controls the Decay value of the Modulation Envelope (see “[The Modulation Envelope](#)”). Also see above for a brief description of Decay.

## Master Volume

This controls the main volume out from the NN-XT. Turn the knob to the right to increase the volume.

# Overview of the Remote Editor panel

It is in the Remote Editor Panel that the main NN-XT action is going on, especially if you're creating your own patches. The remote editor is dominated by the key map display, and this is also the part on which we will concentrate to begin with.

## The Key Map display

The key map display consists of a number of separate areas that let you do different things. To help you navigate the key map display, these areas are described below.

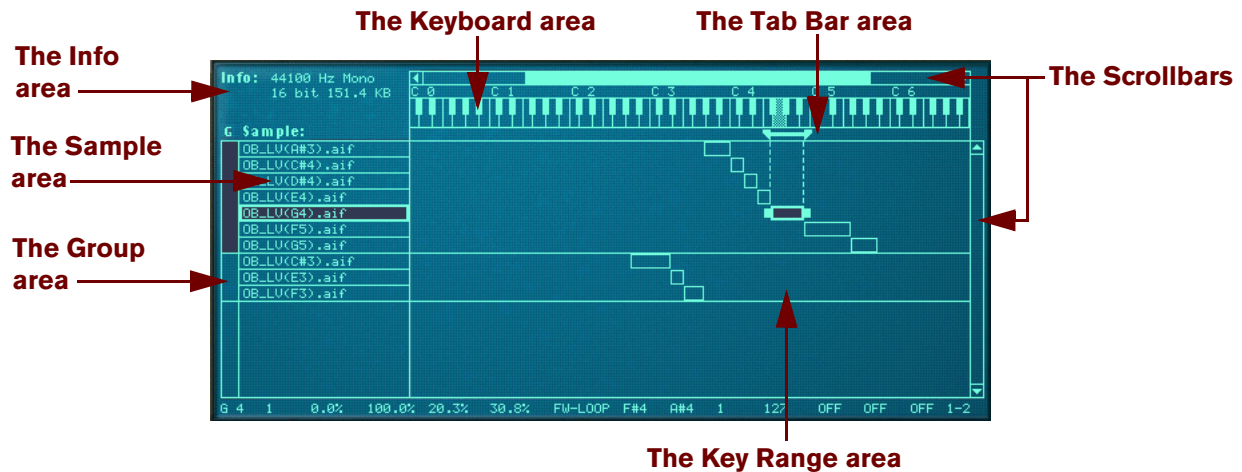

### The Info area

This displays the following information about the currently selected sample: Sample rate, mono/stereo information, bit resolution and file size.

### The Sample area

This area displays the names of the samples in each zone. It also allows you to change the order of the zones by clicking and dragging them up and down.

### The Group area

This area does not show any information. However, by clicking in it, you can instantly select all the zones that belong to a certain group. See ["Working with Grouping"](#) for information on how to create groups.

### The Keyboard area

Aside from the fact that it is a guideline for setting up key ranges, it is also used for setting the root keys of, and auditioning loaded samples. See ["About the Root Key"](#) and ["Auditioning samples"](#) respectively for more information.

### The Tab Bar area

This area gives you a visual indication of the key range of a selected zone. By clicking and dragging the "handles" at the key range boundaries, you can resize the key ranges, and by clicking in between the handles, you can move the key ranges without changing their length.

## The Key Range area

This area in the middle of the key map display is where you keep track of all the zones and the relationship between them. You can also move and resize the zones just like in the Tab Bar area, as described above.

## The Scrollbars

There are both horizontal and vertical scrollbars that work just like regular scrollbars. Whenever there is more information in the key map display than what fits on a “single screen”, you can use the scrollbars to reveal it. Either click on the arrows or click and drag the scrollbar handles.

## Sample parameters



This area shows the current values of basic parameters you can set for zones, such as root key, play mode, output etc. The parameters are changed by using the knobs directly below the key map display.

## Group parameters



These parameters are adjusted on a per group basis (see “[Group parameters](#)” for more information on groups). Most of them relate to performance or playing style.



# Synth Parameters



The bulk of the parameters on the remote editor are used for adjusting the sound of the samples by applying filtering, envelope shaping, modulation (like vibrato and tremolo) and so on. We call these the synth parameters, since they are to a large extent identical to those on a regular synthesizer.

## About Samples and Zones

For a clear understanding of the terminology used when describing the various operations that can be performed in the key map display, it is important to clarify the distinction between a *sample* and a *zone*:

- **A Sample is a piece of audio that can be loaded into the NN-XT and played back.**
- **A Zone could be viewed as a “container” for a loaded sample.**

All loaded samples are placed in “Zones” in the key map display. You can then organize the zones as you please, and make various settings such as key- and velocity ranges separately for each zone.

In other words, the settings you make are actually performed on the zones, but affect the samples in them. Hence, when we talk about making settings for a zone, it is synonymous with making settings for a sample - the sample that the zone contains.

- **Two or more zones can play the same sample, but with different parameter settings, making them sound completely different.**
- **A zone can be empty, playing no sample at all.**

# Selections and Edit Focus

Almost all operations in the remote editor are performed on one or more selected zones or on the zone with edit focus. Several zones can be selected at once, but only one zone at a time can have edit focus.

This is important since:

- **Editing operations that can be performed on several zones (like deleting), always apply to the selected zones.**
- **Editing operations that can be performed on one zone only, always apply to the zone with edit focus.**
- **The front panel always shows the settings for the zone with edit focus.**



Here no zone is selected.



Here the middle zone is selected but does not have edit focus.



Here the middle zone has edit focus but is not selected. Notice the thicker border and the additional handles in the key range area.



Here the middle zone is selected and has edit focus.



Here, all three zones are selected, but the middle one has edit focus.

# Selecting Zones

→ **To select a zone, click on it.**

Clicking on a zone will also automatically give it edit focus.

You can also select multiple zones in several ways:

→ **By holding down [Shift], or [Ctrl](Win) or [Cmd](Mac) and clicking on the zones you wish to select.**

This way you can select several non-contiguous zones. You can also deselect a selected zone by clicking on it again.

→ **By holding down [Ctrl](Win) or [Cmd](Mac) and pressing [A].**

This will select all of the zones in the key map display. To deselect all zones, click in an unoccupied area in the Sample column or the key map area.

→ **By clicking and dragging a selection box in the key map area.**

*Making a selection box like this...*

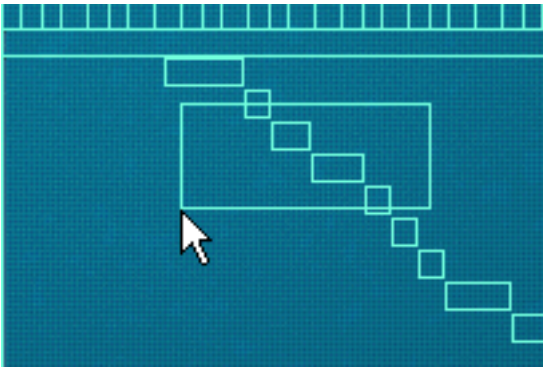

*...will select these zones:*

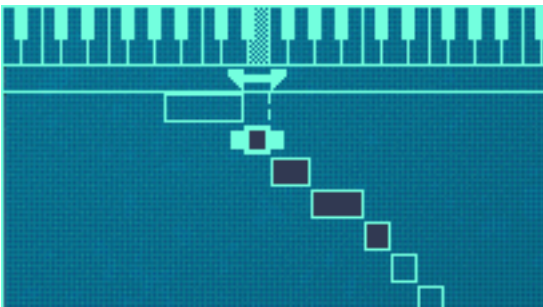

Note that the zones don't have to be completely encompassed by the selection box. The selection box only have to intersect parts of the zones to include them in the selection.

## Selecting zones via MIDI

You can also select zones via your MIDI keyboard. By clicking the button marked “Select zones via MIDI” above the key map display so that it lights up, you enable selection via MIDI.

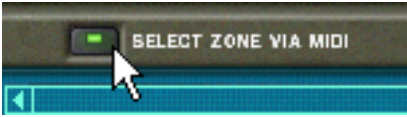

This way, you can select a zone and give it edit focus by pressing a key that lies within the zone's key range (see later in this chapter for information about setting up key ranges).

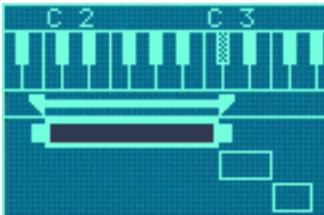

In this case, this zone can be selected by pressing any key between C2 - C3 on your MIDI keyboard.

Note also, that selection via MIDI is velocity sensitive. Zones may have specific velocity ranges. This means that they won't be played unless the key that triggers the zone is played with a certain velocity. The same rules apply when selecting via MIDI, only zones that meet the velocity criteria will be selected. Read more about setting up velocity ranges on “[Setting velocity range for a Zone](#)”.

## Selecting All Zones in a Group

The concept of zone groups is fully introduced on “[Working with Grouping](#)”. For now we will only describe how to select all samples that belong to the same group:

*Clicking in the Group column...*

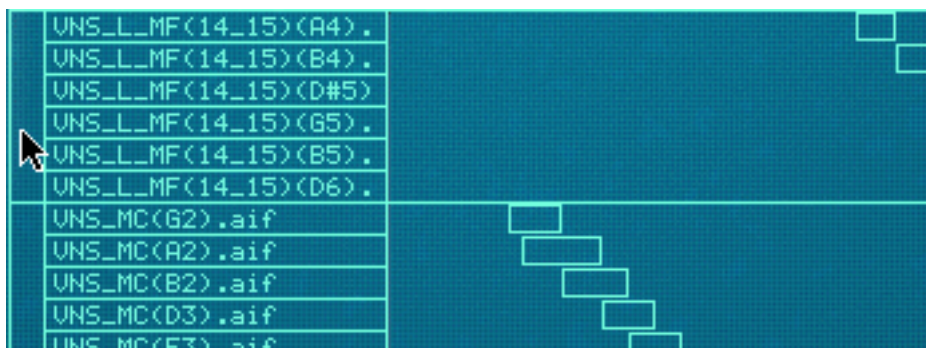

*...selects all zones in the group*

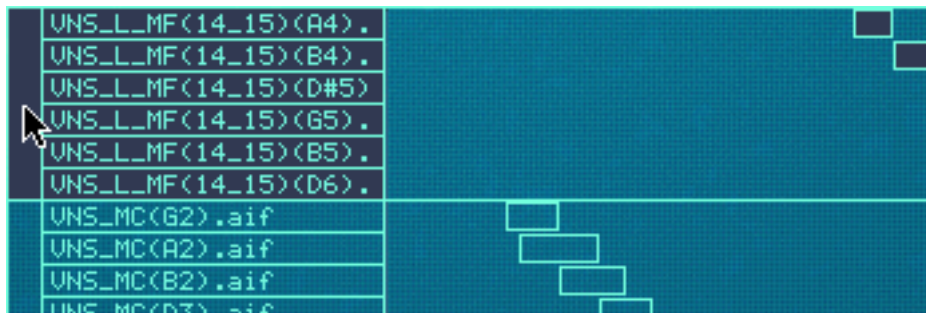

# Moving Edit Focus

## Moving Edit Focus

A zone can be given edit focus independently of selection:

- **When you click on an unselected zone, it both gets selected and gets edit focus.**
- **When you select several zones using [Shift], or [Ctrl](Win) or [Cmd](Mac), the one you select last always gets edit focus.**
- **To set edit focus to a zone when several zones are already selected, click on it without holding down any modifier keys.**

This way, you can move edit focus between the selected zones freely without deselecting any of them.

# Adjusting parameters

## Adjusting Synth parameters

The synth parameters are the ones that occupy the bulk of the remote editor panel (see [“Synth Parameters”](#)). Changes you make to synth parameters always apply to all selected zones.

- **The panel always shows the settings for the zone with edit focus.**  
More about this below.
- **To make adjustments to one zone, select it (which also gives it edit focus) and adjust the parameter on the front panel.**
- **To set several zones to the same value, select them and adjust the parameter.**  
All zones will be set to the same value for the parameter you adjusted.

## Adjusting Group parameters

Group parameters apply to a group. That is, they are settings that are shared by all zones in a group.

- **To make adjustments to one group, select one or more zones that belong to the group, and adjust the parameter on the front panel.**
- **To set several groups to the same value, select at least one zone in each group you want to adjust, and adjust the parameter.**  
All groups will be set to the same value. More about this below.

## About “Conflicting” parameters

Often you will find yourself in a situation where you select multiple zones and parameter settings differ between them. This is quite normal. For example, you will often find yourself making adjustments to for example level and filtering to balance the sound between several samples across the keyboard. However, if you have multiple selections this can sometimes lead to confusion: Enter the NN-XT’s “conflicting parameters” indication:

Whenever two or more *selected* zones have conflicting parameter settings, NN-XT will notify you about this by showing a small “M” (for multiple) symbol, next to the parameter.



*In this example, Level and Spread have conflicting settings.*

- **The controls on the panel always show the setting for the zone with edit focus.**
- **By clicking your way through the zones within the selection, you can see the settings for each zone.**
- **If you adjust a parameter, all selected zones will be set to the same value for this parameter.**

You can put this functionality to good use when checking how a patch has been created and when checking that your own settings are consistent through the various zones.

## Sample parameters

The Sample parameters allow you to specify various properties for one or several selected zones, such as tuning, key and velocity ranges.



- **To set several zones to the same value, select them and adjust the parameter.**  
All zones will be set to the same value for the parameter you adjusted.

## Copying parameters between zones

You can easily copy parameter settings from one zone to any number of other zones. Proceed as follows:

- 1. Select all the zones you want to involve in the operation.**  
By this we mean the zone with the settings you wish to copy, and the zone(s) to which you want to copy the settings.
  - 2. Make sure the zone that contains the settings you want to copy has edit focus.**
  - 3. Pull down the Edit menu or the NN-XT context menu and select “Copy Parameters to Selected Zones”.**  
All the selected zones will now get the exact same parameter settings.
- ! **Observe that this only applies to the synth parameters (see “Synth parameters”). Sample parameters (root key, velocity range etc.) can not be copied.**

# Managing Zones and Samples

## Creating a Key Map

When you add an NN-XT sampler to the rack and select “Reset Device” from the context menu or Edit menu, its key map display becomes empty. That is, it contains no samples.

To create a new key map, proceed as follows:

1. **Either click the Browse Samples button, select Browse Samples from the Edit menu or select Browse Samples from the NN-XT’s context menu.**

The NN-XT device gets browse focus.

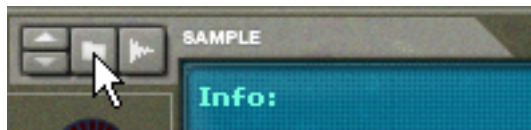

*The Browse Samples button.*

2. **Select the sample or samples that you want to load in the browser and click the “Load” button in the Browser.**  
The selected sample(s) are loaded into the NN-XT.

→ **Alternatively, drag one or several sample files from the Browser and drop it on the NN-XT device in the rack.**  
The panel is dimmed in blue and a Sample Replace symbol appears in the center.

When new samples are loaded into the NN-XT they have the following properties:

- **Each sample is placed in its own zone.**
- **Each zone spans a key range of five octaves on the keyboard - C1 to C6.**
- **All the newly added sample(s)/zones are automatically selected.**
- **The first added zone gets edit focus.**

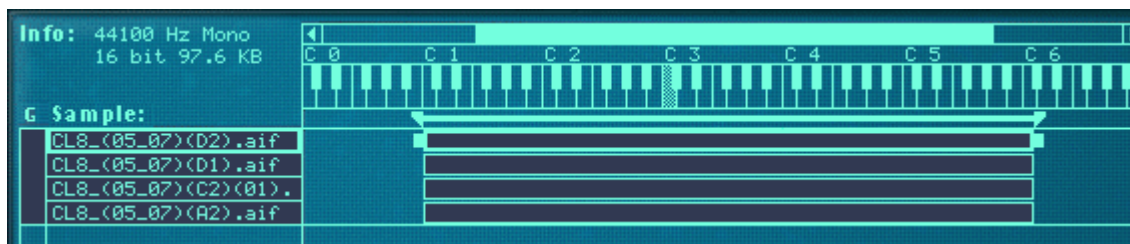

*A key map with four newly added samples.*

## Setting Root Notes and Key Ranges

The next step after loading the samples is most likely to adjust the key range, root note and tuning of the samples, so that they play sensibly across the key range. There are many ways of doing this, described in “[Working with Key Ranges](#)” and onwards. However, we will here briefly describe a procedure for quickly creating a complete key map out of a set of loaded samples.

This example assumes that the samples you load is a set of multisamples for a pitched instrument (like guitar, piano, flute etc.).

1. **Load the samples.**
2. **Use “Select All” on the Edit menu to select all the loaded samples.**
3. **Use “Set Root Notes from Pitch Detection” to automatically set up the root notes (pitches) for the samples.**

#### 4. Select “Automap Zones” from the Edit menu.

All selected zones are automatically arranged into a basic key map. You can now proceed with adjusting the synth parameters on the front panel to shape the sound!

## About file formats and REX slices

The audio file format support differs depending on which computer OS you are using.

The NN-XT can read audio files in the following formats:

- **In Windows 7:**  
.wav, .aif, .mp3, .aac, .m4a and .wma.
- **In Mac OSX 10.7:**  
.wav, .aiff, .3g2, .3gp, .mp1, .mp2, .mp3, .mpeg, .mpa, .snd, .au, .sd2, .ac3, .aac, .adts, .amr, .caf, .m4a, .m4r and .mp4.
- **SoundFont samples**  
This is a standardized data format containing wavetable synthesized audio and information on how it should be played back in wavetable synthesizers - typically on audio cards. SoundFont banks are hierarchically organized into different categories: User Samples, Instruments, Presets etc. The NN-XT lets you load single samples from within a Soundfont bank.
- **REX file slices**  
A slice is a snippet of sound in a REX File (see [“Loading complete REX files as Patches”](#)). To import a REX slice, browse to a REX file and open it as if it was a folder. The browser will then display the slices as files inside that “folder”. In the rest of this manual, when we refer to importing samples, all that is said applies to REX slices as well.
- **Any sample rate and practically any bit depth.**

## Adding more samples to the Key Map

You can add additional samples to an existing key map way described above.

### 1. Make sure that no already loaded sample has edit focus.

If you don't, there's a risk that the selected sample will be replaced, see below. To remove the edit focus, click in an unoccupied area in the Sample column or the key map area.

### 2. Open the Sample Browser.

### 3. Select the sample(s) you want to load in the browser and click the “Load” button in the Browser.

- **Alternatively, drag one or several sample files from the Browser and drop it on the NN-XT device in the rack.**  
The panel is dimmed in blue and a Sample Replace symbol appears in the center.

The new sample(s) are added to the key map.

## Replacing a sample

To replace the sample in a zone, proceed as follows:

### 1. Make sure the zone has edit focus and do one of the following:

- **Click the Browse Samples button.**
- **Select Browse Samples from the Edit menu or the NN-XT context menu.**
- **Double click in the zone.**

Any of these methods will set browse focus and open the standard file browser in which you can select new samples for the zone.



## 2. Select one and only one sample in the Sample Browser.

If you select more than one sample in the browser the samples you load will not replace the one with edit focus. They will instead be added below it.

## 3. Click the Load button in the Browser.

### → Alternatively, drag a sample file from the Browser and drop it on the NN-XT device in the rack.

The panel is dimmed in blue and a Sample Replace symbol appears in the center.

## Quick browsing through samples

If you want to quickly browse through a number of samples, for example to see which one of them would fit best in a certain context, proceed as follows:

### 1. Set up the zone as desired and make sure it has edit focus:

### 2. Use the arrow buttons in the Browse Samples section to select the next/previous sample in the directory.

## Removing samples

### → To remove a sample from a zone, select it by clicking on it and then select “Remove Samples” from the Edit menu or the NN-XT context menu.

This will remove the sample from the zone, leaving it empty. Note that you can remove the samples from several selected zones at the same time.

## Auditioning samples

You can audition the loaded samples in two ways:

### → By pressing [Alt](Win) or [Option](Mac) and clicking a sample in the sample column.

The mouse pointer will take on the shape of a speaker symbol when you move it over the sample column.

Clicking a sample will play it back at its root pitch (see “About the Root Key”). Furthermore, the sample will play back in its unprocessed state. That is, without any synth-parameters applied (see “Synth parameters”).

### → By pressing [Alt](Win) or [Option](Mac) and clicking a sample in the keyboard column.

The difference here is that you will hear the sample at the pitch corresponding to the key you clicked and with any and all processing applied. The click mimics a key played with velocity 100. Also note that this may trigger several samples, depending on whether they are mapped across the same or overlapping key ranges, and the velocity range settings (see “Setting up Key Ranges” and “Setting velocity range for a Zone” respectively).

## Adding empty Zones

You can add empty zones to a key map. Empty zones are treated just like zones containing samples, in that they are automatically selected, gets edit focus and are assigned a five octave key range when they are first created. However, you can only add one zone at a time. It is also possible to resize, move and edit empty zones in the same way as zones containing samples.

### → To add an empty zone, pull down the Edit menu or the NN-XT context menu and select “Add Zone”.

An empty zone is added below any existing zones in the key map. An empty zone is indicated with the text “\*\*No Sample\*\*”.

After you have added an empty zone, you can assign a sample to it, just as when Replacing a Sample, or when Quick Browsing, as described above.

## Duplicating Zones

You can duplicate any number of already existing zones (containing samples or empty).

**1. Select the zone(s) you want to copy.**

**2. Pull down the edit menu or the NN-XT context menu and select “Duplicate Zones”.**

The selected zones will now be copied and automatically inserted below the last one in the key map display.

The duplicated zones will contain references to the same samples as the original zones. They will also have the exact same key ranges and parameter settings.

## Using Copy and Paste

The Copy Zones function on the Edit menu allows you to copy all selected zones to the clipboard. Selecting Paste Zones from the Edit menu will paste the zones into the selected NN-XT device, below the existing zones.

This is a handy way to transfer zones (complete with all settings) from one NN-XT device to another.

## Removing Zones

To remove one or several zones, select them and do one of the following:

- **Press [Delete] or [Backspace] on the computer keyboard.**
- **Select “Delete Zones” from the Edit menu or the NN-XT context menu.**

When removing zones, you will remove any samples in them as well.

## Rearranging Zones in the List

- **To move a zone to another position in the list, click on it in the samples column and drag up or down.**

An outline shows you where the zone will appear when you release the mouse button.

## Working with Grouping

### About Groups

Grouping has two purposes:

- **To allow you to quickly select a number of zones that “belong together.”**

For example if you have created a layered sound consisting of piano and strings, you could put all string samples in one group and all piano samples in one group. Then you can quickly select all piano samples and make an adjustment to them by trimming a parameter.

- **To group zones that need to share group settings together.**

For example, you may want to set a group to legato and monophonic mode and add some portamento so that you can play a part where you slide between notes.

Note that there is always at least one group, since the zones you create are always grouped together by default.

### Creating a Group

- 1. Select the zones you want to group together.**

The zones don't have to be contiguous in order to be grouped. Regardless of their original positions in the samples column, they will all be put together in succession.

## 2. Select “Group Selected Zones” from the Edit menu or the NN-XT context menu.

The zones are grouped.

*Selecting these zones and grouping them...*

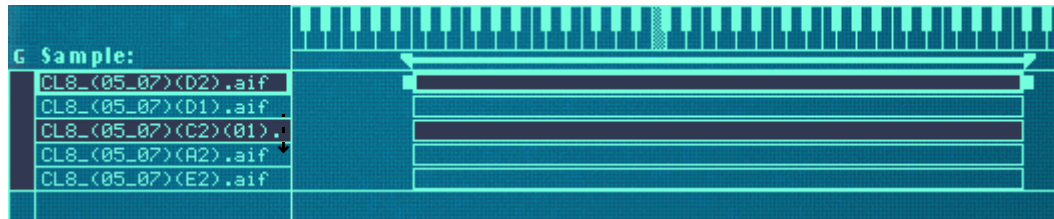

*...will create these two groups instead of the original one large group.*

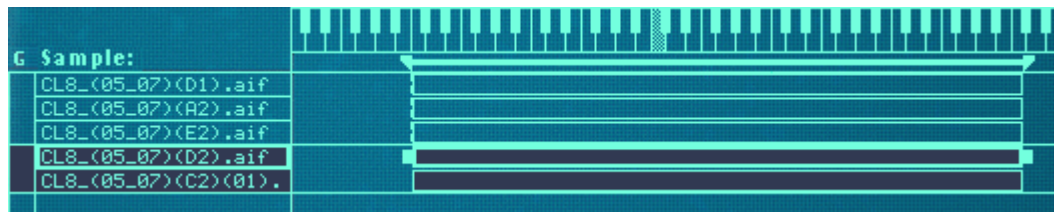

## Moving a Group to another position in the List

→ Click on the group in the Groups column and drag up or down with the mouse button pressed.

An outline of the group you move is superimposed upon the display to help you navigate to the desired position.

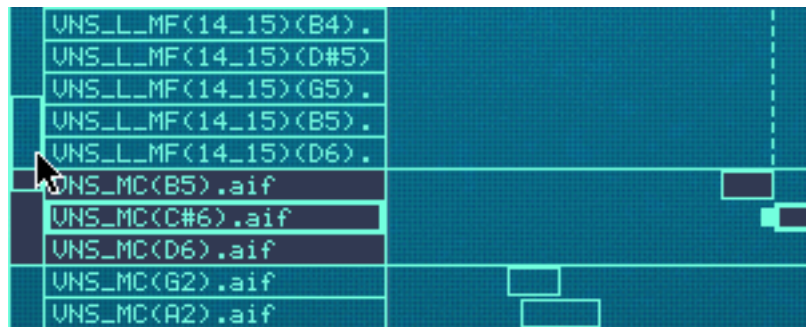

*Dragging a group to a new position.*

3. Release the mouse button at the desired position.

The group and all its zones appear at the new position.

## Moving a Zone from one Group to another

This is done just as when rearranging samples in the list, as described on the previous page. The only difference is that you drag the zone from one group to another.

## Selecting a Group and/or Zones in a Group

→ Clicking on a group in the groups column selects the group and all the zones in the group.

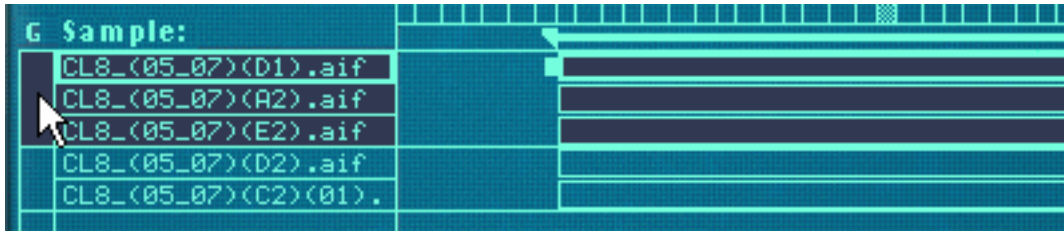

→ Clicking on a zone in the samples column selects the group (and that zone).

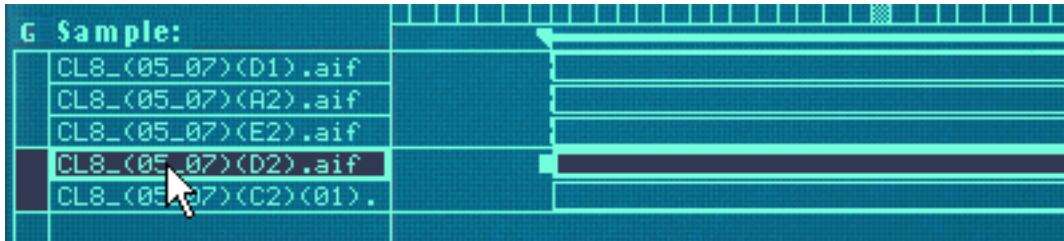

## The Group Parameters

There are a few parameters on the front panel that apply specifically to groups. see [“Group parameters”](#) for details.

## Working with Key Ranges

### About Key Ranges

Each zone can have its own separate key range, the lowest and the highest key that will trigger the sample.

A good example of use for this is when sampling a certain instrument. Sampling of a piano for example is usually performed by making several recordings of different notes at close intervals, and then mapping these samples to separate, contiguous, fairly narrow key ranges. This concept is called multi-sampling.

The reason for this is that if one single sample is played across the entire keyboard, it will most likely sound very unnatural when played too far from its original pitch, since the amount you can transpose a sound without negatively affecting its timbre is very limited.

### Setting up Key Ranges

You can adjust the key range of zones in a number of ways:

#### By Dragging the Zone Boundary Handles

1. Select the zone in the Key Range area.
2. Point and click on one of the handles that appear at each end.

### 3. Drag the handle left/right.

Dotted lines extend from the edges of the zones up to the keyboard area. These lines give you a visual indication of which keys the key range will encompass. There is also an alphanumeric indication at the bottom left of the display.

*Clicking and dragging the high key boundary handle of a zone with the default key range of C1 - C6..*

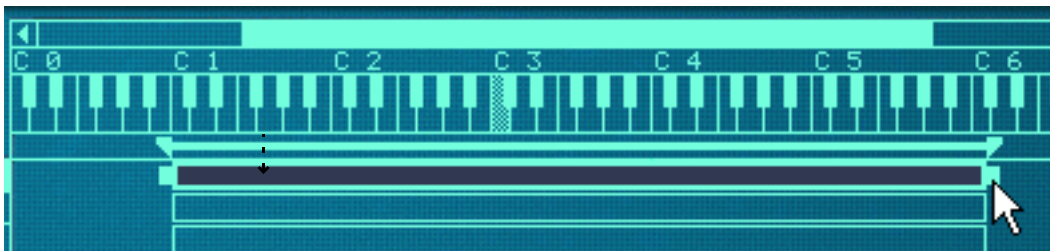

*...to change the key range to C1 - C2.*

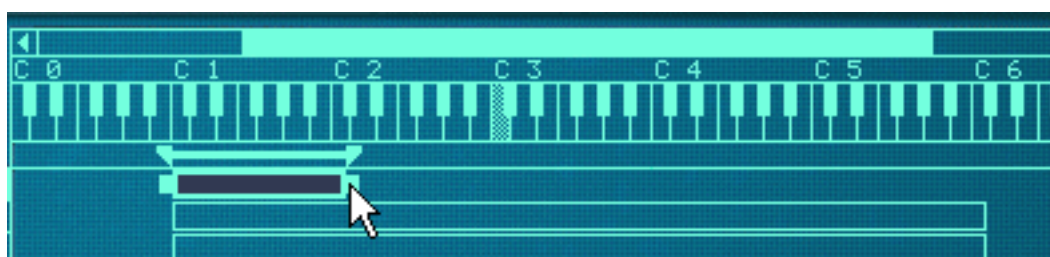

### 4. Repeat the procedure with as many zones as you wish, to create a complete key map.

## By using the Lo Key and Hi Key controls

Directly below the key map area you will find the sample parameters. These are used for changing various parameters that affect how the zones are played back. They can affect single or multiple selected zones. In the middle of the sample parameters area are two knobs called "Lo Key" and "Hi Key".



These can be used for setting the low key and the high key of a zone's key range.

#### 1. Make sure the zone which you want to set the key range for is selected.

#### 2. Use the Lo Key/Hi Key knobs to change the key range.

Check the display right above the knobs for an indication of the key. You can also keep an eye on the lines extending from the zone edges to the keyboard area.

Setting key ranges for multiple zones

You can set key ranges for multiple selected zones simultaneously. This can only be done by using the Lo and Hi Key controls. It works as follows:

- **If you have three selected zones that each have different high keys and then turn the Hi Key knob, they will all automatically get the same High Key value as the zone with edit focus.**

In other words, if the selected zone with edit focus has the high key set to C4, and you change this to D4 by turning the Hi Key knob, all other selected zones will also be extended to D4 as the High Key.

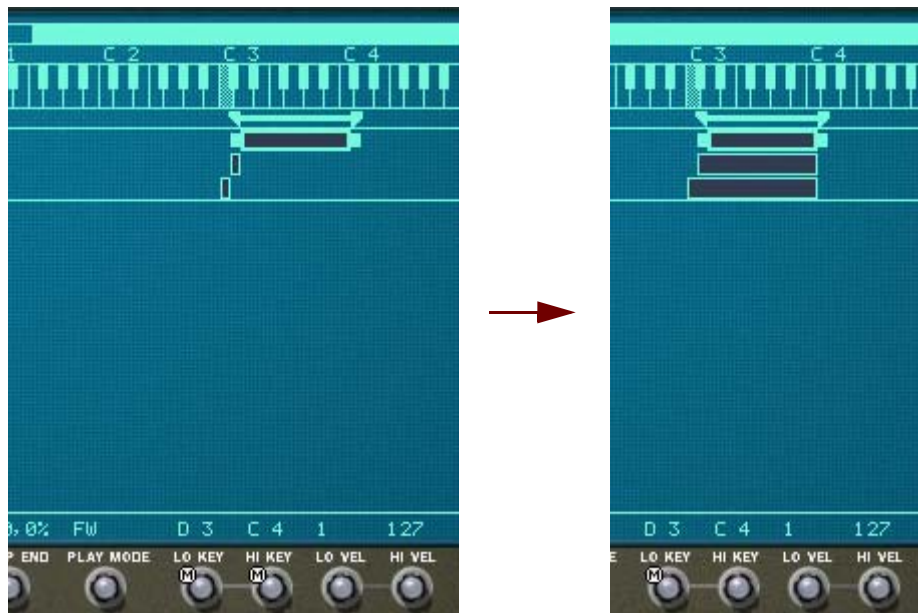

- **If any selected zone's low key setting is higher than the edit focused zone's high key before turning the Hi Key knob, the zone range will be scaled down to one semitone, starting from the low key setting.**

The high key can naturally never be set to a value lower than one semitone above its low key setting - the zone would otherwise disappear!

- **The inverse is also true - i.e. turning the Lo Key knob for several selected zones will apply the edit focused low key setting to all selected zones.**

A low key can never be set higher than one semitone below the high key in a zone, so if the edit focused zone has a low key above the high key of another zone, the other zone will be scaled to the minimum semitone range.

## By Dragging the Zone Boundary Handles on the Tab Bar

As previously described, the area directly below the keyboard area is called the tab bar. This shows the key range for the currently selected zone, and also contains boundary handles.

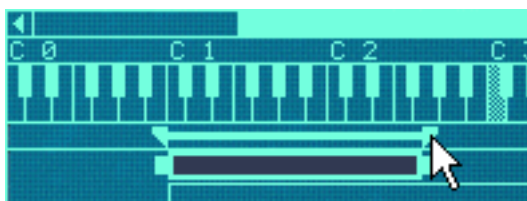

*Dragging a boundary handle on the tab bar.*

These handles can be used much to the same effect as when dragging the boundary handles in the key map display. However, the handles on the tab bar can change the key range of multiple zones at the same time.

The following applies:

- **The tab bar shows the key range for the zone with edit focus.**

- Dragging the boundary handles for that zone will also simultaneously change the key range for a number of surrounding zones if:
  - The high key or low key (depending on which handle you drag) of the other zones are the same as the zone with edit focus.
  - The other zones are adjacent to the zone with edit focus.
- ! Note that it doesn't matter whether the other zones are selected or not. They will be affected anyway.

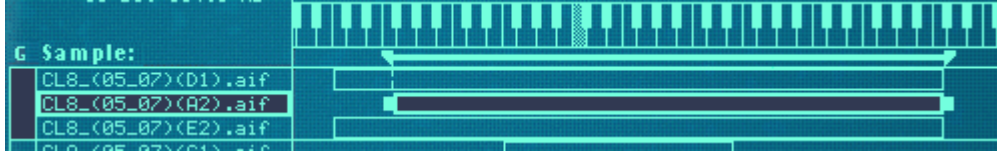

In the example in the picture above, the zone in the middle has edit focus. Its left handle (the low key) is placed differently from any of the other zones, but all of the zones have the same high key setting. This means that..

- Dragging the left handle will only move the low key position of the zone with edit focus (the pictures show before and after dragging).



- Dragging the right handle will move the high key position for all of the zones at the same time, since they all have the same high key position (again, the picture shows before and after dragging).

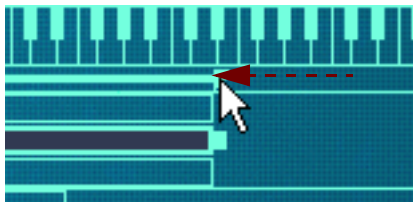
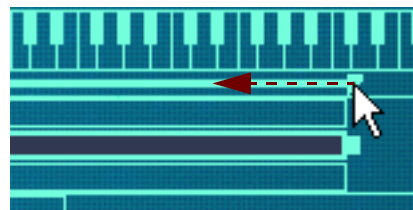

## Moving Zones by Dragging the Zone Boxes

You can also move entire zones horizontally, thereby changing their key ranges.

**1. Select all the zones you want to move.**

You can move several zones simultaneously.

**2. Point on any of the selected zones, and press the mouse button.**

**3. Drag left/right and release the mouse button.**

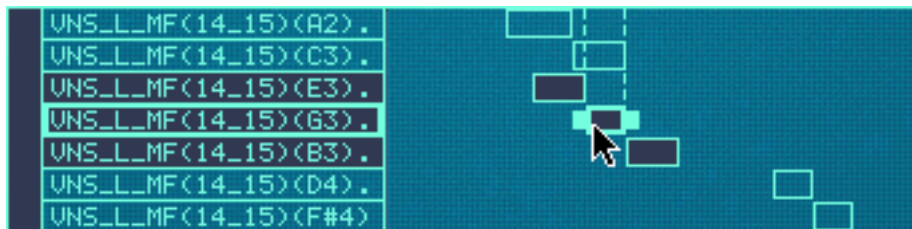

*Dragging multiple zones.*

## Moving Zones by Dragging in the Tab Bar

You can also move a zone by dragging anywhere between the zone boundary handles on the tab bar. When you do, the surrounding zones will be affected just as when dragging the boundary handles in the tab bar (see above).

This can be used to “slide” a zone in relation to its surrounding zones, as the picture example below shows (before and after dragging).

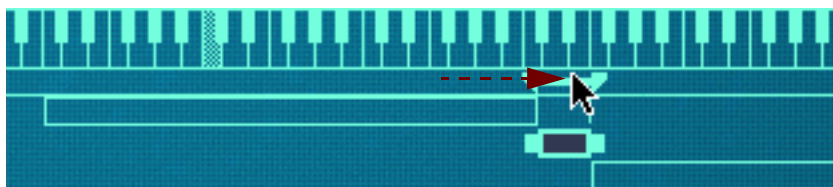
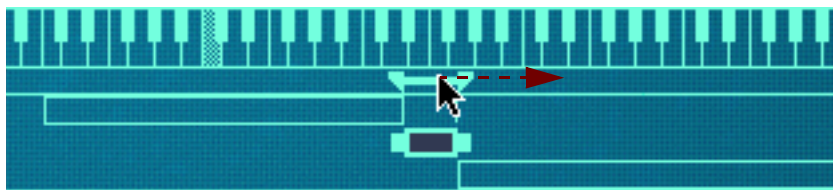

## About the Lock Root Keys function

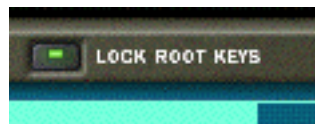

Normally, when you move zones (as described above), the root note of the zone(s) you move will change accordingly. In other words, the zone(s) will be transposed. If this is not desired, you can activate the Lock Root Keys function prior to moving the zone(s) by clicking on the button above the key map display.

Moving zones without changing their root notes can be used for some interesting effects, since it will completely change the timbre of the sample(s) as they are played back.



## About the Solo Sample function

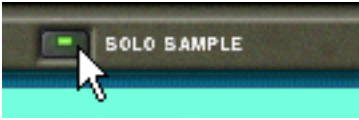

The Solo Sample function lets you play a selected sample over the entire keyboard and disregarding any velocity range assigned to the sample. All other loaded samples are temporarily muted.

This is useful if you for example want to check how far up and down from its root key a sample can be played on the keyboard before starting to sound “unnatural”. The solo sample function can therefore be useful as a guide for setting up key ranges, as described in [“Setting up Key Ranges”](#).

- 1. Select one and only one zone, or - if you have a selection of multiple zones - make sure the one you want to hear has edit focus.**
- 2. Activate Solo Sample by clicking on the button so that it lights up.**
- 3. Play the MIDI keyboard**

## Sorting Zones by Note

The Edit menu and the NN-XT context menu contains an item called “Sort Zones by Note”. This option lets you automatically sort the selected zones in descending order according to their key ranges.

When you invoke this option, the selected zones will be sorted from top to bottom in the display starting with the one with the lowest range.

Note however, that the sorting is done strictly on a group basis. That is, only zones that belong to the same group can be sorted in relation to each other.

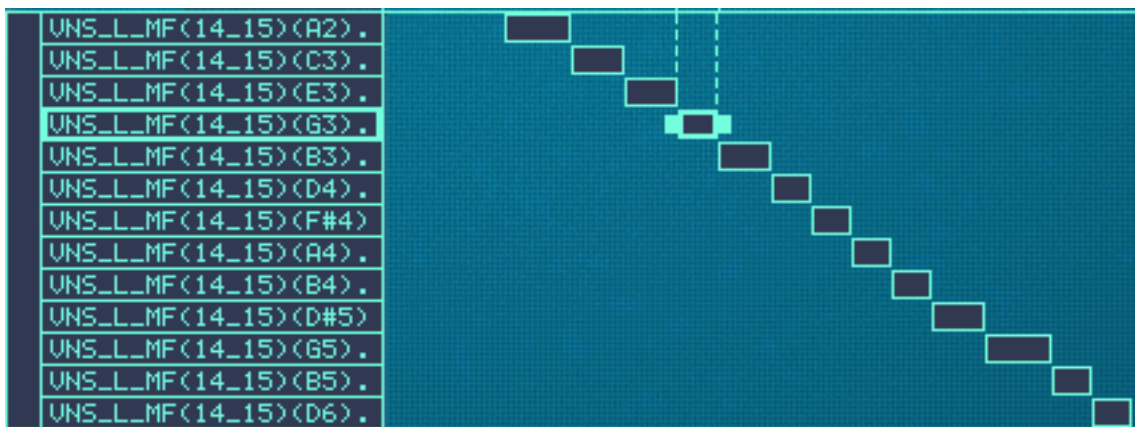
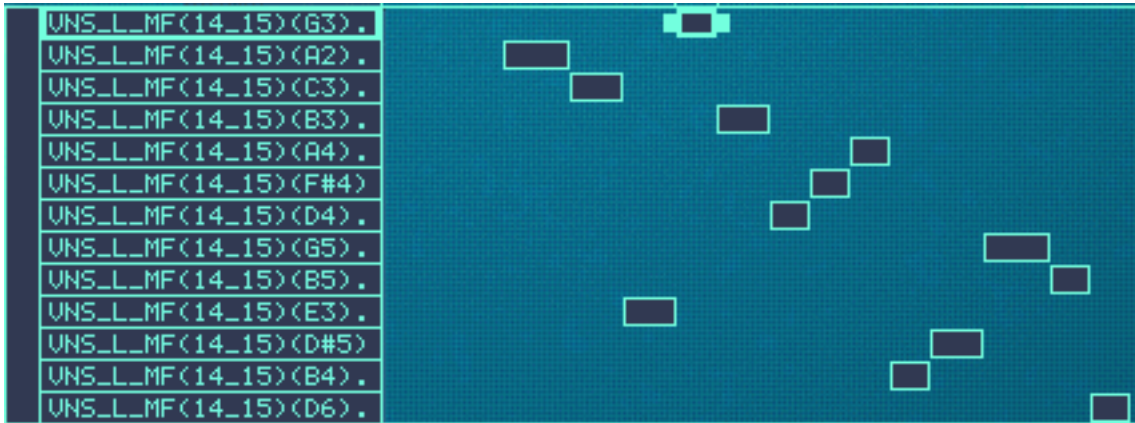

*Before sorting and after.*

If two zones have the same key range, they are sorted by velocity range.

# Setting Root Notes and Tuning

## About the Root Key

All instrument sounds have an inherent pitch. When playing a sample of such a sound on the keyboard, the keys you play must correspond to that pitch. For example, you may have recorded a piano playing the key “C3”. When you map this onto the NN-XT key map, you must set things up so that the sampler plays back the sample at original pitch when you press the key C3.

This is done by adjusting the root note.

- **Many samples files from different sources already have a set root key in the file. If they do, the root key will be correctly set automatically when you load the sample into a zone.**
- **However if the sample doesn't have a root note stored in the file, (if you for example have recorded it yourself) you will need to adjust it**

## Setting the Root Note manually

To set the root key for a zone, proceed as follows:

- **Make sure the zone has edit focus (for example by clicking on it), and do one of the following:**
- **Use the knob marked “Root” in the sample parameter area below the display.**  
Turning it to the right will raise the pitch of the root key. The selected key is displayed alphanumerically directly above the knob, and you can also look at the keyboard area for a visual indication (see below).



- **Press [Ctrl](Win) or [Cmd](Mac) and click on the desired root key in the keyboard area.**  
The set root key is shaded so you can easily distinguish it.

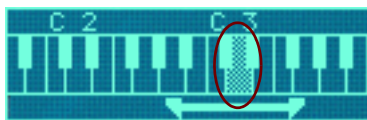

## Tuning samples manually

In addition to setting the root note, you may need to fine tune your samples, in order for them to match other instruments and/or each other:

- **Make sure the zone has edit focus (for example by clicking on it).**
- **Use the knob marked “Tune” in the sample parameter area.**  
This allows you to tune each sample in a key map by +/- half a semitone (-50 – 0 – 50).



## Setting the Root Note and Tuning using pitch detection

The NN-XT features a pitch detection function to help you set the root keys. This is useful if you for example load a sample that you haven't recorded yourself, and you don't have any information about its original pitch.

Proceed as follows:

**1. Select all the zones you want to be subject to pitch detection.**

**2. Pull down the Edit menu or the NN-XT context menu and select “Set Root Notes from Pitch Detection”.**

The samples in all the selected zones will now be analyzed, and the detected root keys will automatically be set for you.

**! Note that for this to work properly, the samples must have some form of perceivable pitch. If it is sampled speech, or a snare drum for example, it probably doesn't have any discernible pitch.**

## About changing the pitch of samples

The procedures above should be used to make sure the samples are consistently pitched across the keyboard, and that they all match an absolute reference (for example A 440 tuning).

If you need to tune the samples to match other material, or to get a certain effect (for example detuning two sounds against each other for a chorus effect) you should use the Pitch section among the synth parameters, not the sample tuning parameters.

## Using Automap

The automap function can be used as a quick way of creating a key map, or as a good starting point for further adjustments of a key map.

Automap works under the assumption that you intend to create a key map for a complete instrument, for example a number of samples of a piano, all at different pitches.

**1. Load the samples you want to Automap.**

Now you have three options:

- **Trust that the root note information in the files is already correct.**
- **Manually adjust the root notes (and tuning) for all the samples.**
- **Use “Set Root Notes from Pitch Detection” to automatically set up the root notes.**

**2. Select all zones you want to automap.**

**3. Select Automap Zones from the Edit menu or the NN-XT context menu.**

All the selected zones will now be arranged automatically in the following way:

- **The zones will be sorted in the display (from top to bottom - lowest key first) according to the root keys.**
- **The zones will be assigned key ranges according to the root keys.**

The key ranges are set up so that the split between two zones is exactly in the middle between the zones' root notes. If two zones have the same root key they will be assigned the same key range.

## Automapping zones chromatically

- **This Edit menu item will give each zone a key range of one semitone (i.e. one key), starting from C2 and upwards.**

The function does not take root key into account. It simply places each selected sample on successive keys according to the position in the sample list (from the top down).

# Layered, crossfaded and velocity switched sounds

## Creating layered sounds

You can set things up so that two or more zones have overlapping key ranges - either completely or partially. This way you can create layered sounds, i.e. different samples that are played simultaneously when you press a key on your keyboard.

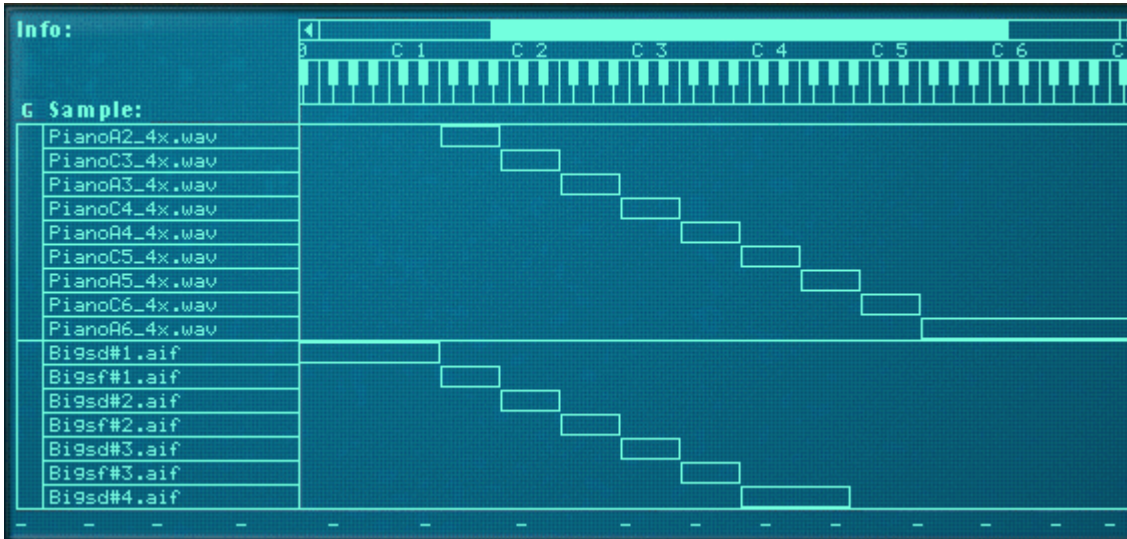

In the picture above, you can see a set of piano samples at the top, mapped across the key range.

Below these are a set of string samples that also span the entire key range.

Whenever you play a key within this keyboard range, the sound produced will be a combination of the piano and the string sample.

In addition, in the example above, the user has arranged the piano samples into one group and the string samples in another. This is convenient since it allows for quick selection of the entire piano map, for example for balancing its level against the strings.

## About velocity ranges

When zones are set up so that their key ranges overlap – completely or partially – you can use velocity switching and crossfading to determine which zones should be played back depending on how hard or soft you play on your MIDI keyboard.

This is done by setting up velocity ranges, with or without crossfading.

Each time you press a key on your MIDI keyboard, a velocity value between 1-127 is sent to Reason. If you press the key softly, a low velocity value is sent and if you press it hard, a high velocity value is sent.

This velocity value determines which samples will be played and which will not.

Let's say for example that you've mapped three different zones across the same key range:

- **Zone 1 has a velocity range from 1-40.**  
This means that the sample in it will be triggered by velocity values between 1-40.
- **Zone 2 has a velocity range of 41-80.**  
The sample in this zone will be played back by velocity values between 41-80.

- **Zone 3 has a velocity range of 81-127.**

The sample in this zone will be triggered by all velocity values above 80.

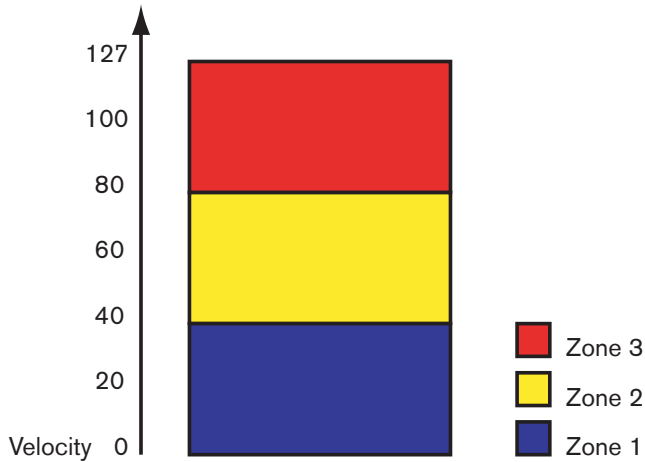

### Overlapping velocity ranges

Let's change the values above slightly:

- **Zone 1 has a velocity range from 1-60.**
- **Zone 2 has a velocity range of 41-100.**
- **Zone 3 has a velocity range of 81-127.**

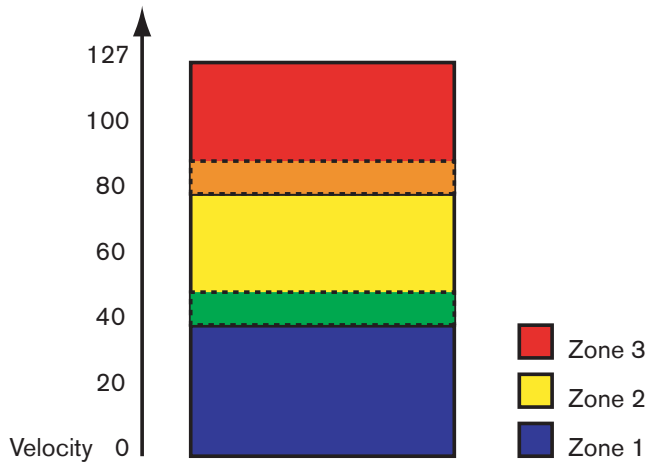

Now, velocity values between 41 and 60 will trigger samples from both Zone 1 and Zone 2. Likewise, velocity values between 81 and 100 will trigger sounds from Zone 2 and Zone 3.

## About full and partial velocity ranges

You can see which zones have modified velocity ranges in the key map display:

- **Zones with a full velocity range (0 - 127) are only shown with an outline.**
- **Zones with any other velocity range are shown as striped.**

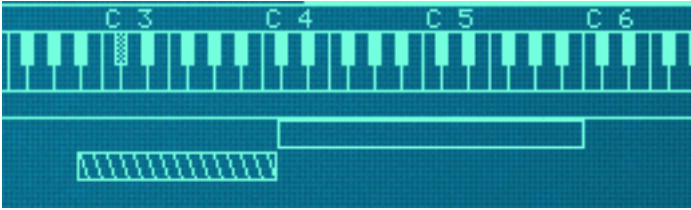

The top zone has a full velocity range (1-127), and the lower zone has a partial velocity range (any other range), which is indicated by stripes

## Sorting Zones by velocity values

The Edit menu and the NN-XT context menu contain an item called “Sort Zones by Velocity”. This option lets you automatically sort the selected zones in the display in descending order according to their set low or high velocity values.

When you invoke this option, the selected zones will be sorted from top to bottom starting with the one with the highest “Lo Vel” value.

Note however, that the sorting is done strictly on a *group* basis. That is, only zones that belong to the same group can be sorted in relation to each other.

If two zones have the same velocity range, they are sorted by key range.

## Setting velocity range for a Zone

To set up a velocity range for a zone, proceed as follows:

1. **Select one or more zones that you want to adjust.**
2. **Use the knobs marked “Lo Vel” and “High Vel” in the sample parameter area to set the desired low- and high velocity values.**



Adjusting the “Lo Vel” value for a zone.

“Lo vel” is the lowest velocity value that should trigger the sample in the zone - i.e. if a key is pressed so softly that the velocity is lower than this value, the sample will not be played.

“Hi vel” is the highest velocity value that should trigger the sample, which means that if a key is pressed so hard that the velocity is higher than this value, the sample will not be played.

## About Crossfading Between Zones

At the bottom right in the sample parameter area are two knobs marked “Fade In” and “Fade Out”. These are primarily used for setting up velocity crossfades for smooth transitions between overlapping zones. In order to set up crossfades you adjust the fade out and fade in values for the overlapping zones.

## Crossfading Between two Sounds

An example:

- **Two zones are both set to play in the full velocity range of 1-127.**

- **Zone 1 has a fade out value of 40.**

This means that this zone will play at full level with velocity values below 40, With higher velocity values, it will gradually fade out.

- **Zone 2 has a fade in value of 80.**

This has the effect that as you play velocity values up to 80, this zone will gradually fade in. With velocity values above 80, it will play at full level.

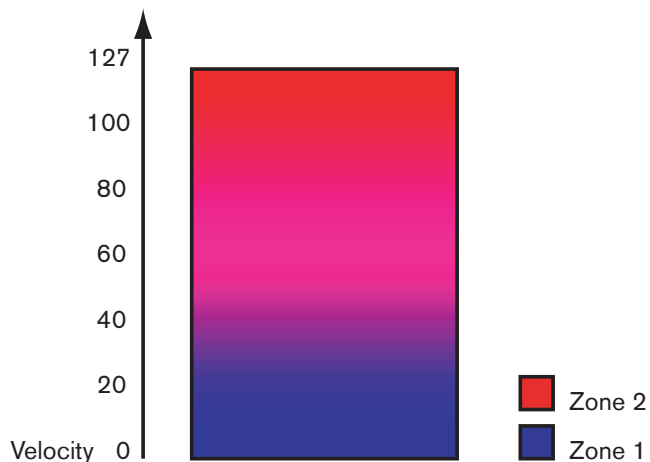

Another example:

Crossfading can be used to only fade in or fade out a certain sound. One common example is to set things up so that one sound plays the entire velocity range and another is faded in only at high velocity values.

- **Zone 1 is set to play the entire velocity range with no crossfade.**

- **Zone 2 is set to play the velocity range 80 to 127, with a fade in value of 110.**

This means that this zone will start fading in from velocity values 80 and will play at full level in the velocity range 110 to 127.

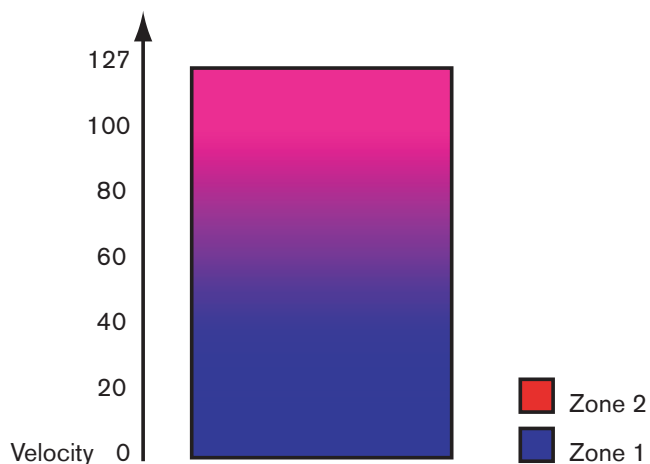

This can be used for example to add a rimshot to a regular snare sound or a harder attack to a softer violin sample.



# Setting crossfading for a Zone

## Manually

To set up a crossfade for a zone, proceed as follows:

1. **Select one or more zones that you want to adjust.**
2. **Use the knobs marked “Fade In” and “Fade Out” in the sample parameter area, to set the desired values.**



- You can change the values with finer precision by pressing [Shift] while turning the knobs, and you can reset the standard values by pressing [Command] (Mac)/[Ctrl] (Windows) and clicking on the knobs.

## Automatically

If you find it tedious to manually set up crossfades between zones, NN-XT can do it for you! The Edit menu and the NN-XT context menu contain an item called “Create Velocity Crossfades”.

1. **Set up the zones so that their velocity ranges overlap, as desired.**

2. **Select the zones.**

You can select as many zones as you wish, not just one pair of overlapping zones.

3. **Select “Create Velocity Crossfades” from the Edit menu.**

NN-XT will analyze the overlapping zones and automatically set up what it deems to be appropriate fade in and fade out values for the zones.

- **This operation will not work if both zones have full velocity ranges.**  
At least one of the zones must have a partial velocity range (see “About full and partial velocity ranges”).
- **This operation will not work if the zones are completely overlapping.**

# Using Alternate

## About the Alternate function



At the bottom right in the sample parameters area is a knob marked “Alt”. It only has two states - On and Off. This is used for semi-randomly alternating between zones during playback.

There are several practical uses for this. Here follows two examples:

- **Layering several recordings of the same snare drum. By alternating between them you get a more natural repetition.**
- **Layering string up- and down strokes. By alternating you get the realistic effect of switching between the two directions of the stroke.**

You can layer as many sounds as you will and the algorithm switches between them in a way that provides as little repetition as possible.

To set up an alternating set of zones, proceed as follows:

1. **Set up the zones so that they overlap completely or partially.**
2. **Select them all.**
3. **Set “Alt” to On for all the zones.**

Now, the program will automatically detect how to alternate between the zones, depending on their overlap.

## Sample parameters



The Sample parameter area is found below the screen. They allow you to adjust parameters for one or several selected zones. Adjusting a parameter with multiple zones selected, will set the parameter to the same value for all selected zones. Below follows a run-down of the various parameters:

### Root Note and Tune

These parameters are described in [“Setting Root Notes and Tuning”](#).

### Sample Start and End

By turning the knobs you offset the start and end positions, so that they will play back more or less of a sample's waveform. Typical examples of use for this would be:

- **Removing unwanted portions from samples.**  
This could be anything from noise to “dead air” at the beginning or end of a sample.
  - **To create variations out of a single sample.**  
These controls can be used to pick out any section of a recording for use as a sample.
  - **Together with velocity sample start control.**  
You can for example increase Sample Start and then apply negative velocity modulation to Sample Start. Then, the harder you play the more you will hear of the attack portion of the sound.
- If you hold down [Shift] when adjusting these parameters, the adjustment is in single frames (samples).

### Loop Start and End

A sample, unlike the cycles of an oscillator for example, is a finite quantity. There is a sample start and end. To get samples to play for as long as you press down the keys on your keyboard, they need to be looped. For this to work properly, you have to first set up two loop points which determine the part of the sample that will be looped.

The instrument samples in the sound banks included with Reason are already looped. The same will be true for most commercial sample libraries. However, if you need to, you can use these controls to adjust the looping.

- **The size and position of the loop – in the sample – is determined by two parameters, Loop Start (the beginning of the loop) and Loop End (the end point of the loop).**
- **The NN-XT then keeps repeating the section between the Loop Start and Loop end until the sound has decayed to silence.**

## Play Mode

By using this knob you can select one of the following loop modes for each zone:

- **FW**  
The sample in the zone will play only once, without looping.
- **FW-LOOP**  
The sample will play from the sample start point to the loop end point, jump back to the loop start point and then loop infinitely between the start and end loop points. This is the most common loop mode.
- **FW - BW**  
The sample will play from the sample start point to the loop end point, then from the loop end point to the loop start point (backwards), and then loop infinitely forwards-backwards between the start and end loop points.
- **FW-SUS**  
This works like FW-LOOP with the exception that it will only loop as long as the key is held down. As you release the key, the sample will play to the absolute end of the sample, that is beyond the boundaries of the loop.  
  
This means that the sound may have a short natural release even if the release parameter is raised to a high value (which is not true for “FW-LOOP”, where the release parameter always controls the length of the sound after the key is released).
- **BW**  
The sample will play only once - from the end to the beginning - without looping.

## Lo Key and Hi Key

These parameters are described in [“Setting up Key Ranges”](#).

## Lo Vel and Hi Vel

These parameters are described in [“About velocity ranges”](#).

## Fade In and Fade Out

These parameters are described in [“About Crossfading Between Zones”](#).

## Alt

This parameter is described in [“About the Alternate function”](#).

## Out

The NN-XT features eight separate stereo output pairs (see [“Audio Output”](#)). For each zone, you can decide which of these output pairs to use. Thus, if you have created a key map consisting of eight zones, each of these can have a separate stereo output from NN-XT, and can then be routed to a separate mixer channel if you so wish.

→ **To select which output a selected zone should be directed to, use the knob marked “Out” in the sample parameter area.**

The output pairs are indicated above the button.

! **Note that you still have to route the outputs the way you want them on NN-XT’s back panel. If you assign a zone to an output pair other than 1-2 (which is the default) no connections or auto routing are made. You have to do that manually.**

## A Stereo example

One possible way of utilizing this would be to create a drum kit. In this case you could load up to eight different stereo drum samples, assign them to separate outputs, route each to a separate mixer channel and then use the mixer to set levels and pan, add send effects etc.

## Using a stereo output as two mono outputs

If, on the other hand, you are using mono samples, you can use one stereo pair as a two separate outputs, effectively giving you a total of 16 separate outputs.

1. **Assign two zones to the same output.**
2. **Use the Pan control to pan one of the zones hard left and the other hard right.**
3. **Connect each of the two outputs in the stereo pair to a separate mixer channel.**

## Group parameters



The group parameters are located at the top left on the remote editor panel. These are parameters that in various ways are directly related to playing style.

Group parameters apply to a group, that is they are settings that are shared by all zones in a group.

- **To make adjustments to one group, select one or more zones that belong to the group, and adjust the parameter on the front panel.**
- **To set several groups to the same value, select at least one zone in each group you want to adjust, and adjust the parameter on the front panel.**

## Key Poly

This setting determines the number of keys that you can play simultaneously (the polyphony). The maximum number is 99 and the minimum is 1, in which case the group will be monophonic.

Users of other samplers may want to note that the polyphony often means setting the number of *voices* that should be able to play. The NN-XT is different in this aspect, since the polyphony setting instead determines the number of *keys*, regardless of how many voices each key plays.

## The Group Mono button

The Group Mono button beside the Key Poly section can be used to quickly set a group to play monophonically regardless of the polyphony setting. E.g. if you have a group with open and closed hi hats, you can switch this on so that an open hi hat is automatically muted when you play a closed hi hat.

Group Mono overrides the Key Poly setting - except when playing the same note.

So you can play your open hi-hat repeatedly without the sound cutting itself off. When you play the closed hi-hat, this cuts off the open hi-hat.

Note that activating this button is not the same as setting polyphony to 1. E.g., it can not be used for Legato or mono Retrig (see “[Legato and Retrig](#)”).

## Legato and Retrig

### Legato

Legato works best with monophonic sounds. Set Key Poly (see above) to 1 and try the following:

- **Hold down a key and then press another key without releasing the previous.**  
Notice that the pitch changes, but the envelopes do not start over. That is, there will be no new “attack”.
- **If Key Poly is set to more voices than 1, Legato will only be applied when all the assigned keys are “used up”.**  
For example, if you had a polyphony setting of “4” and you held down a 4 note chord, the next note you played would be Legato. Note, however, that this Legato key will “steal” one of the keys in the 4 note chord, as all the assigned keys were already used up!

### Retrig

Retrig is the “normal” setting for playing polyphonic patches. That is, when you press a key without releasing the previous, the envelopes are triggered, like when you release all keys and then press a new one. In monophonic mode, Retrig has an additional function; if you press a key, hold it, press a new key and then release that, the first note is also retriggered.

## LFO 1 Rate

This is used for controlling the rate of LFO 1 if it is used in “Group Rate” mode. In that case, this knob will take precedence over the rate parameter in the LFO 1 section. See “[The LFOs](#)” for detailed information about this.

## Portamento

This is used for controlling portamento - a parameter that makes the pitch glide between the notes you play, rather than changing the pitch instantly as soon as you hit a key on your keyboard. By turning this knob you set how long it should take for the pitch to glide from one note to the next as you play them.

In legato mode, there will only be any portamento when actually playing legato (tied) notes.

With the knob turned all the way to the left, portamento is disabled.

# Synth parameters

## The Modulation controls



As previously described, the Modulation wheel (and the External Control wheel) can be used for controlling various parameters. These controls allow you to define which parameters the wheels should modulate and to what extent.

- **Below each of the knobs are the letters “W” and “X”.**  
These are used for selecting the source that should control the parameter, and represent the “Modulation Wheel” and the “External Control wheel” respectively.
- **By clicking on any of the letters, you decide which source should control the parameter.**  
You can select either, both or none. When a letter is “lit”, the corresponding source is set to control the parameter.
- **By turning the knobs, you decide how *much* the modulation and/or external control wheel should modulate the corresponding parameter.**

Note that all of the control knobs are bi-polar, which means that they can be set to both positive and negative values. Positive values are set by turning the knobs to the right, and negative values are thus set by turning the knobs to the left:

- **Setting them to positive values means that the value of the controlled parameter will be raised if the source wheel is pushed forward.**
- **Setting them to negative values means that the value will be lowered when a wheel is pushed forward.**
- **Keeping the knobs in the center position means that no modulation control is applied.**

There is one exception to these rules, and that is the LFO 1 Amt control, which works in a slightly different way. See below for more information about this.

The following parameters can be modulated:

### F.Freq

This sets modulation control of the Filter’s cutoff frequency (see [“The Filter section”](#)).

### Mod Dec

This sets modulation control of the Decay parameter in the Modulation Envelope (see [“The Modulation Envelope”](#)).

## LFO 1 Amt

This determines how much the amount of modulation from LFO 1 is affected by the Modulation wheel and/or the External Controller wheel. It does this by “scaling” the amounts set with the three destination knobs in the LFO 1 section (Pitch, Filter and Level, see [“The LFOs”](#)). We’ll explain this with an example:

To use the Modulation Wheel to *increase* pitch modulation (vibrato), proceed as follows:

- 1. Turn the Mod Wheel all the way down, so that no modulation is applied.**
- 2. Activate the “W” button for LFO 1 Amt in the Modulation section.**
- 3. Set the corresponding knob to “12 o’clock” (zero).**
- 4. Set up LFO 1 so that as much vibrato is applied as you want it to be when the Modulation wheel is turned all the way up.**
- 5. Increase LFO 1 Amt until you hear as much vibrato as you want it to be when the wheel is turned all the way down.**

If you turn LFO 1 Amt all the way up, there will be no vibrato at all when the wheel is all the way down.

To instead use the Modulation wheel to *decrease* vibrato, process as follows:

- 1. Turn the Mod Wheel all the way down, so that no modulation is applied.**
- 2. Activate the “W” button for LFO 1 Amt in the Modulation section.**
- 3. Set the corresponding knob to “12 o’clock” (zero).**
- 4. Set up LFO 1 so that as much vibrato is applied as you want it to be when the Modulation wheel is turned all the way down.**
- 5. Turn the Modulation wheel all the way up.**
- 6. Decrease LFO 1 Amt until you hear as much vibrato as you want it to be when the wheel is turned all the way up.**

If you turn LFO 1 Amt all the way down, there will be no vibrato at all when the wheel is all the way up.

## F.Res

This sets modulation control of the Resonance parameter in the Filter (see [“The Filter section”](#)).

## Level

This sets the amount of amplitude envelope modulation of each zone’s level. The level set here will be the level of the highest point of the Amp Envelope.

## LFO 1 Rate

This sets modulation control of the Rate parameter in LFO 1 (see [“The LFOs”](#)).

## The Velocity controls



Velocity is used for controlling various parameters according to how hard or soft you play notes on your keyboard. A typical use of velocity control is to make sounds brighter and louder if you strike a key harder. By using the knobs in this section, you can control if and how much the various parameters will be affected by velocity.

Just like the modulation controls, all of the velocity control knobs are bi-polar, and can be set to both positive and negative values.

- **Setting them to positive values means that the value of the controlled parameter will be raised the harder you play.**
- **Setting them to negative values means that the value will be lowered the harder you play.**
- **Keeping the knobs in the center position means that no velocity control is applied.**

The following parameters can be velocity controlled:

### F.Freq

This sets velocity control of the Filter's cutoff frequency (see ["The Filter section"](#)).

### Mod Dec

This sets velocity control of the Decay parameter in the Modulation Envelope (see ["The Modulation Envelope"](#)).

### Level

This sets velocity control of the Amp Envelope.

### Amp Env Attack

This sets velocity control of the Attack parameter in the Amplitude Envelope (see ["The Amplitude Envelope"](#)).

### Sample Start

This sets velocity control of the Sample Start parameter (see ["Sample Start and End"](#)), so that it will be offset forwards or backwards, according to how hard or soft you play.

This allows you to control how much of the attack portion of the sample you hear when playing harder or softer.

To be able to make use of negative values for this parameter, you must increase the sample parameter Sample Start.



## The Pitch section



This section contains various parameters related to controlling the pitch, or frequency, of the zones.

### Pitch Bend Range

This lets you set the amount of pitch bend, i.e. how much the pitch changes when you turn the pitch bend wheel fully up or down. The maximum range is +/- 24 semitones (2 Octaves).

### Setting the pitch

Use the three knobs marked "Octave", "Semi" and "Fine" to change the pitch of the sample(s):

- **Octave**  
This changes the pitch in steps of one full octave. The range is -5 – 0 – 5.
- **Semi**  
This lets you change the pitch in semitone steps. The range is -12 – 0 – 12 (2 octaves).
- **Fine**  
This changes the pitch in cents (hundredths of a semitone). The range is -50 – 0 – 50 (down or up half a semitone).

### K. Track

This knob controls Keyboard Tracking of the pitch.

- **In the center position, each key represents a semitone This is the normal setting.**
- **When turned all the way down, all keys play the same pitch. This can be useful for percussion like timpani where you might want to play the same pitch from a range of keys.**
- **When turned all the way up, each key on the keyboard shifts the pitch one octave.**

## The Filter section



Filters can be used for shaping the character of the sound. The filter in NN-XT is a multimode filter with six different filter types.

→ **To activate/deactivate the filter, click the On/Off button in the top right corner.**

When the filter is activated, the button is lit.

### Filter mode

To select a filter mode, either click the Mode button in the bottom right corner or click directly on the desired filter name so that it lights up:

- **Notch**  
The notch filter is used for cutting off frequencies in a narrow frequency range around the set cutoff frequency, while letting the frequencies below and above through.
- **HP 12**  
This is a highpass filter with a 12 dB/Octave roll-off slope. A highpass filter cuts off low frequencies and lets high frequencies pass. That is, frequencies below the cutoff frequency are cut off and frequencies above it pass through.
- **BP 12**  
This is a bandpass filter with a 12 dB/Octave roll-off slope. A bandpass filter could be viewed as the opposite of a notch filter. It cuts off both the high and the low frequencies, while frequencies in the band range pass through.
- **LP 6**  
This is a lowpass filter with a gentle, 6 dB/Octave slope. A lowpass filter is the opposite of a highpass filter. It lets the low frequencies through and filters out the high frequencies. This filter has no Resonance.
- **LP 12**  
This is a lowpass filter with a 12 dB/Octave roll-off slope.
- **LP 24**  
This is a lowpass filter with a fairly steep roll-off slope of 24 dB/Octave.

## Filter controls

The following filter controls are available:

- **Freq**

This is used for setting the filter cutoff frequency. The cutoff frequency determines the limit above or below which frequencies will be cut off depending on the selected filter type. In the case of a lowpass filter for example, frequencies below the cutoff frequency will be allowed to pass through, while frequencies above it will be cut off. The farther to the right you turn the knob, the higher the cutoff frequency will be.

- It is very common to modulate filter frequency with the modulation envelope, as described in **“The Modulation Envelope”**.

- **Res**

Technically, this knob controls feedback of the output signal from the filter, back to its input. Acoustically it emphasizes frequencies around the cutoff frequency. For a lowpass filter for example, increasing Res will make the sound increasingly more hollow until the sound starts “ringing”. If you set a high value for the Res parameter and then vary the filter frequency, this will produce a classic synthesizer filter sweep.

For the notch and bandpass filter types, the Resonance setting instead adjusts the width of the band. That is, the higher the resonance setting, the narrower the band will be where frequencies are cut off (notch) or let through (Bandpass).

- **K. Track**

This lets you activate and control keyboard tracking of the filter frequency. If keyboard tracking is activated, the set cutoff frequency of the filter will change according to the notes you play on your keyboard. That is, if you play notes higher up on the keyboard, the filter frequency will be raised and vice versa.

When the knob is set to its center position, filter frequency is adjusted so that the harmonic content remains constant across the keyboard.

Keyboard tracking is deactivated by default (the knob all the way to the left). This means that the filter frequency will remain unchanged regardless of where on the keyboard you play.

## The Modulation Envelope



The Modulation Envelope parameters let you control how certain parameters, or destinations, should change over time - from the moment a note is struck to the moment it is released again.

The destinations you can use are:

- **Pitch**
- **Filter frequency**

## Parameters

The following are the available controlling parameters:

- **Attack**  
When you press a key on your keyboard, the envelope is triggered. The attack parameter then controls how long it should take before the controlled parameter (pitch or filter) reaches the maximum value, when you press a key. By setting attack to a value of "0", the destination parameter would reach the maximum value instantly. By raising the attack parameter, the value will instead slowly "slide" up to its maximum.
- **Hold**  
This is used for deciding how long the controlled parameter should stay at its maximum value before starting to decrease again. This can be used in combination with the Attack and Decay parameters to make a value reach its maximum level, stay there for a while (hold) and then start dropping gradually down to the sustain level.
- **Decay**  
After the maximum value for a destination has been reached and the Hold time has expired, the controlled parameter will start to gradually drop down to the sustain level. How long it should take before it reaches the sustain level is controlled with the Decay parameter. If Decay is set to "0", the value will immediately drop down to the sustain level.
- **Sustain**  
The Sustain parameter determines the value the envelope should drop back to after the Decay. If you set Sustain to full level however, the Decay setting doesn't matter since the value will never decrease.  
  
A combination of Decay and Sustain can be used for creating envelopes that rise up to the maximum value, then gradually decrease to, and stay on a level somewhere in-between zero and maximum.
- **Release**  
This works just like the Decay parameter, with the exception that it determines the time it takes for the value to fall back to zero *after* the key is released.
- **Delay**  
This is used for setting a delay between when a note is played and when the effect of the envelope starts. That is, the sound will start unmodulated, and the envelope will kick in after you have kept the key(s) pressed down for a while. Turn the knob to the right to increase the delay time. If the knob is set all the way to the left, there will be no delay.
- **Key To Decay**  
By using this, you can cause the value of the Decay parameter (see above) to be offset depending on where on your keyboard you play. If you turn the knob to the right the decay value will be raised the higher up you play, and turning the knob to the left will lower the decay value the higher up you play. With the knob in the center position, this parameter is deactivated.

## Destinations

The following are the available Mod Envelope destinations:

- **Pitch**  
This will make the envelope modulate the pitch, as set in the Pitch section (see "[The Pitch section](#)"). Turn the knob to the right to raise the pitch and to the left to lower the pitch. In the middle position, pitch will not be affected by the envelope.
- **Filter**  
This will make the envelope modulate the cutoff frequency of the Filter (see "[The Filter section](#)"). Turn the knob to the right to increase the frequency and to the left to lower the frequency. In the middle position, the envelope will have no effect on the cutoff frequency.

# The Amplitude Envelope



The Amplitude Envelope parameters let you control how the volume of a sound should change over time - from the moment a note is struck to the moment it is released again.

## Parameters

Most of the Amplitude Envelope parameters are identical to those of the Modulation Envelope. So for a detailed description of the following parameters, please refer to the modulation envelope section in [“The Modulation Envelope”](#):

- **Attack**
- **Hold**
- **Decay**
- **Sustain**
- **Release**
- **Delay**
- **Key To Decay**

The following are the parameters that are unique for the Amp Envelope section:

- **Level**  
This knob sets the level of the zone. Turn it to the right to raise the level.
- **Spread and Pan modes**  
These two parameters are used for controlling the stereo (pan) position of the sound. The Spread knob determines the sound's width in the stereo image (how far left – right the notes will be spread out). If this is set to “0”, no spread will take place. The Mode selector switch is used for choosing which type of spread you want to apply:

Mode	Description
Key	This will make the pan position shift gradually from left to right, the higher up on the keyboard you play.
Key 2	This will make the pan position shift from left to right and then back again from right to left in a sequence of eight keys. Playing 4 adjacent semitones thus makes the pan position gradually go from left to right. The next 4 higher semitone notes will then change the pan position from right to left in the same way, and this cycle will then be repeated.
Jump	This will make the pan position jump between left and right each time a note is played.

- **Pan**

This controls the stereo balance of the output pair to which a zone is routed. In the middle position, the signal appears equally strong on the left and right channel in a stereo pair. By turning the knob to the left or right, you can change the stereo balance.

Note that if you for instance turn the Pan knob all the way to the left, you cause the signal to be output from the left channel of the stereo pair only.

You can use this to treat a stereo output as two independent mono outputs, if required.

See "Out" for information on routing zones to output pairs.

## The LFOs



NN-XT features two Low Frequency Oscillators - LFO 1 and LFO 2. "Normal" oscillators generate a waveform and a frequency, and produce sound. *Low frequency* Oscillators on the other hand, also generate a waveform and a frequency, but there are two major differences:

- **LFOs only generate sounds of a low frequency.**
- **LFOs don't produce sound, but are instead used for modulating various parameters.**

The most typical use of an LFO is to modulate the pitch of a sound (generated by an oscillator or - in the case of NN-XT - a sample), to produce vibrato.

### About the Difference between LFO 1 and LFO 2

There are two fundamental differences between LFO 1 and LFO 2:

- **LFO 2 is always key synced, that is, each time you press a key, the LFO waveform starts over from scratch. LFO 1 can be switched between key synced and non-key synced modes.**
- **LFO 2 only has one waveform, triangle.**

The following parameters are available for the LFOs:

## Rate (LFO 1 and 2)

This knob controls the frequency of the LFO. For a faster modulation rate, turn the knob to the right. The Rate knob of LFO 1 is also used for setting the timedivision when synchronizing the LFO to the song tempo (see below).

## Delay (LFO 1 and 2)

This can be used for setting a delay between when a note is played and when the LFO modulation starts kicking in (gradually). This way, you can make the sound start unmodulated, and then have the LFO modulation start after you have kept the key(s) pressed down for a while.

Turn the knob to the right to increase the delay time.

## Mode (LFO 1 only)

This lets you set the “operation mode” for the LFO. Click the button to switch between the available modes:

- **Group Rate**  
In this mode, the LFO will run at the rate set for its group in the group section, rather than at the rate set here (see “Group parameters”). This way, all zones in the group will have the exact same modulation rate.
- **Tempo Sync**  
In this mode, the LFO will be synchronized to the song tempo, in one of 16 possible time divisions.  
**! When tempo sync is activated, the Rate knob is used for selecting the desired timedivision. Turn the Rate knob and observe the tool tip for an indication of the timedivision.**
- **Free Run**  
In free run mode, the LFO simply runs at the rate set with the Rate parameter. Furthermore, if Key Sync is deactivated, the modulation cycle will not be retriggered each time you press a key - it will run continuously.

## Waveform (LFO 1 only)

Here, you select which type of waveform should be used for modulating the destination parameters.

Click the button to switch between the following waveforms:

Waveform	Description
Triangle	This is a smooth waveform, suitable for normal vibrato.
Inverted Sawtooth	This produces a “ramp up” cycle. If applied to an oscillator’s frequency, the pitch would sweep up, after which the cycle immediately starts over.
Sawtooth	This produces a “ramp down” cycle, the same as above but inverted.
Square	This produces cycles that abruptly change between two values, usable for trills etc.
Random	Produces random stepped modulation to the destination. Some vintage analog synths called this feature “sample & hold”.
Soft Random	The same as above, but with smooth modulation.

**! LFO 2 always uses a triangle waveform.**

## Key Sync (LFO 1 only)

By activating key sync, you “force” the LFO to restart its modulation cycle each time a key is pressed.

**! Note that LFO 2 always uses Key Sync.**

## Destinations for LFO 1

The following parameters can be modulated by LFO 1:

- **Pitch**  
This will make the LFO modulate the pitch, for vibrato, trills, etc. It can be set to -2400 – 0 – 2400 cents which equals 4 octaves. The set pitch will change up and down by this amount, with each modulation cycle. Turning the knob to the right will make the modulation cycle start above the set pitch, while turning it to the left will invert the cycle. Keeping this in the middle position means that the pitch will not be affected by the LFO.
- **Filter**  
This will make the LFO modulate the cutoff frequency of the Filter, for auto-wah effects, etc. The positive/negative effect is the same as for pitch.
- **Level**  
This will make the LFO modulate NN-XT's output level, for tremolo effects, etc. The positive/negative effect is the same as for pitch.

## Destinations for LFO 2

The following parameters can be modulated by LFO 2:

- **Pan**  
This makes the LFO modulate the pan position of a zone. The sound will move back and forth in the stereo field. Turning the knob to the left makes the sound move from left to right, and turning it to the right thus makes it move from right to left. The middle position provides no modulation at all.
- **Pitch**  
Just like for LFO 1 (see above), this makes LFO 2 modulate the pitch. The range is also the same as for LFO 1.



# Connections

On the back panel of NN-XT are a number of connectors. Many of these are CV/Gate related. Using CV/Gate is described in the chapter “Routing Audio and CV”.



## Sequencer Control

The Sequencer Control CV and Gate inputs allow you to play the NN-XT from another CV/Gate device (typically a Matrix or a Redrum). The signal to the CV input controls the note pitch, while the signal to the Gate input delivers note on/off along with velocity.

## Modulation Input

These control voltage (CV) inputs (with associated voltage trim pots), can modulate various NN-XT parameters from other devices. These inputs can control the following parameters:

- **Oscillator Pitch**
- **Filter Cutoff Frequency**
- **Filter Resonance**
- **LFO 1 Rate**
- **Master Volume**
- **Pan**
- **Modulation Wheel**
- **Pitch Wheel**

## Gate Input

These inputs can receive a CV signal to trigger the following envelopes:

- **Amplitude Envelope**
- **Modulation Envelope**

Note that connecting to these inputs will override the normal triggering of the envelopes. For example, if you connect a Matrix Gate Out to the Gate In Amp Envelope, you would not trigger the amp envelope by playing notes, as this is now controlled by the Matrix Gate Out. In addition you would only hear the Gate Out triggering the envelope for the notes that you hold down.

## Audio Output

There are 16 audio output jacks on the NN-XT's back panel - eight separate *stereo pairs*. When you create a new NN-XT device, the first output pair (1L & 2R) is auto-routed to the first available channel on the audio mixer.

The other output pairs are never automatically routed. If you wish to use any of the other output pairs, you have to manually connect them to the desired device - typically a Mix Channel device. The basics on Routing is described in [“Routing Audio and CV”](#).

**! Note that when you use any other output pair than the first, you also have to route one or more zones to it if you want it to actually output sound, since all zones by default are routed to outputs 1 & 2. How to route zones to other outputs is described in the [“Out”](#) section.**

**Chapter 34**  
**Dr. Octo Rex**  
**Loop Player**

# Introduction



The Dr. Octo Rex Loop Player is the successor to the trusty Dr. Rex Loop Player, introduced in Reason Version 1. The Dr. Octo Rex can hold up to eight different REX loops at once, in eight pattern memories, and allows you to switch between loops and slices in very flexible ways. The Dr. Octo Rex Loop Player is fully backwards compatible with the discontinued Dr. Rex device. This means that all REX loops that previously used Dr. Rex devices in your songs will now open and play back in Dr. Octo Rex devices instead. The loops will sound exactly the same as they did in Dr. Rex. The Dr. Octo Rex Loop Player is capable of playing back and manipulating files created in ReCycle, another product created by Propellerhead Software, or bounced from open Single Take audio clips in Reason (see [“Bounce Clip to REX Loop”](#)). ReCycle is a program designed especially for working with sampled loops. By “slicing” an audio loop and making separate samples of each beat, ReCycle makes it possible to change the tempo of loops without affecting the pitch and to edit the loop as if it was built up of individual sounds.

## ReCycled Loops

To fully understand Dr. Octo Rex you need to understand what it means to ReCycle a drum loop. Imagine that you have a sample of a drum loop that you want to use in a track you are working on. The loop is 144 BPM and your track is 118 BPM. What do you do? You can of course lower the pitch of the loop, but that will make the loop sound very different, and if the loop contains pitched elements they will no longer match your song. You can also time stretch it. This won't alter the pitch, but will make the loop sound different. Usually it means that you lose some “punch” in the loop.

Instead of stretching the sample, ReCycle slices the loop into little pieces so that each drum hit (or whatever sound you are working with) gets its own slice. These slices can be exported to an external hardware sampler or saved as a REX file to be used in Reason. When the loop has been sliced you are free to change the tempo any way you want. You can also create fills and variations since the slices can be moved around in the sequencer.

# About REX file formats

Dr. Octo Rex can read REX files in the following formats:

- **REX (.rex)**  
This is the file format generated by previous versions of ReCycle (Mac platform).
  - **RCY (.rcy)**  
This is the file format generated by previous versions of ReCycle (PC platform).
  - **REX 2 (.rx2)**  
This is the ReCycle file format for both Mac and PC platforms generated internally in Reason (see [“Bounce Clip to REX Loop”](#)) or by ReCycle version 2.0. One of the differences between the original REX format and REX2, is that the REX2 format supports stereo files.
- ! **Unlike the Dr. Rex device, Dr. Octo Rex can also load and save the device panel settings in a special Patch format (.drex). The REX file(s) and the Dr. Octo Rex panel settings are also saved in the Song file just like every other patch in the song.**

## Loading and saving Dr. Octo Rex patches

Loading and saving Dr. Octo Rex patches is done in the same way as in other patch based devices - see [“Loading patches”](#) and [“Saving patches”](#).

Dr. Octo Rex patches can consist of up to eight separate REX loops. When you load an Dr. Octo Rex patch, the REX loop(s) will be automatically loaded in the Loop Slots with their names shown in the display(s) below each button.

- **You can also load Dr. Octo Rex patches by dragging them from the Browser and dropping on the device panel.**



## About the Dr. Octo Rex patch format

Dr. Octo Rex patches (.drex) contains all panel and synth parameter settings as well as references to all (up to eight) REX loops. The actual REX files are not contained in the patch but must be available separately on the computer.

## About opening songs that previously used Dr. Rex devices

Songs created in earlier versions of Reason that used Dr. Rex devices will open just fine in this version of Reason. Any Dr. Rex devices will be replaced by Dr. Octo Rex devices and the corresponding REX loop will load in Loop Slot 1. The original Dr. Rex device settings will be translated as follows:

- **The panel parameter settings are automatically applied to the Dr. Octo Rex device.**  
This makes the loop play back and sound exactly like it did when you created it in Dr. Rex.
- **The Enable Loop Playback button on Dr. Octo Rex will be set to Off.**
- **Any automation for Level and Transpose are converted to Master Level and Global Transpose.**
- **Routing to CV Mod Input Level is routed to Master Volume.**
- **The Dr. Octo Rex is set to “Master Keyboard Input to Slices” Mode, so that it behaves exactly like the old Dr. Rex.**

# Playing Loops

1. Make sure the Enable Loop Playback button is on (lit).

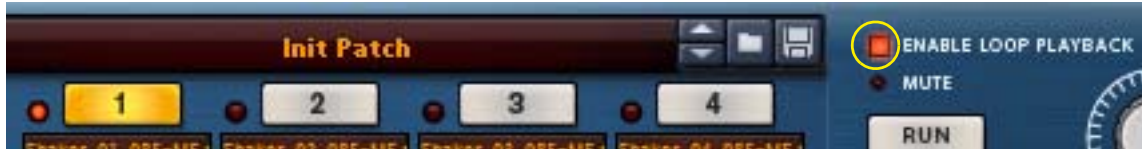

2. Click the desired Loop Slot button.
3. Play back the loop by clicking the Run button.

The loop in the selected Loop Slot will play back repeatedly in the tempo set on the Transport Panel. If you change the tempo, the loop tempo will follow.

- You can also play the loop once via MIDI, by using the D0 key.
- To check out the loop(s) together with other device sequencer data and patterns already recorded, click the sequencer Play button.  
The loops will automatically play back in perfect sync with the sequencer.

## Switching playback between Loop Slots

Switching playback between loops in different Loop Slots is just like switching a Pattern in a Redrum device, for example.

1. Activate the Enable Loop Playback button on the Dr. Octo Rex device.
2. Click the Run button - or start sequencer playback.
3. Click another Loop Slot button to switch loop.

Selecting Loop Slots that have no loops loaded will result in silence.

## The Trig Next Loop function

The Trig Next Loop function determines how long Dr. Octo Rex waits after a Loop Slot button (or a key) is pressed before it actually “gates in” or triggers the loop. This allows for different “precision” when switching between running loops:

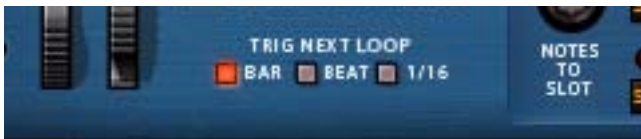

- Activate the Bar button to make the loops switch at the next bar of the current loop.
- Activate the Beat button to make the loops switch at the next beat of the current loop.
- Activate the 1/16 button to make the loops switch at the next 1/16th note of the current loop.

## Switching Loops using Pattern Automation in the sequencer

Switching between Loop Slots can be automated, by using Pattern Automation in the main sequencer.

- ! When using Pattern Automation, the Trig Next Loop function described above is disregarded - the switching between Loop Slots is instantaneous.

Refer to “[Pattern automation recording details](#)” for details about Pattern Automation.

- ! When you use the Pencil tool to draw Pattern Automation clips and select Pattern in the Inspector, the Bank selection is of no importance since Dr. Octo Rex doesn't make use of Banks.

## Triggering playback and selecting Loop Slots from a MIDI keyboard

It's also possible to control playback, stop and Loop Slot selection in real-time by pressing different keys on a MIDI keyboard. By pressing the keys E0 to B0 you select Loop Slot 1-8 and start playback of the corresponding loop. The loop(s) will play back continuously, one loop at a time, until you press the D#0 key to stop playback, or click the Run button or Stop in the main sequencer. The time between key press and Loop Slot switching is determined by the Trig Next Loop function, see ["The Trig Next Loop function"](#).

**! Note that the Enable Loop Playback button must be on.**

The picture shows what keys should be pressed to select and play Loop Slot and to stop loop playback:

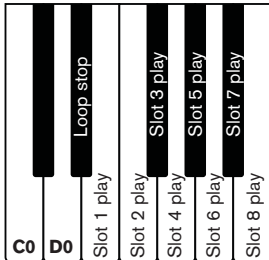

- **To maintain backwards compatibility with Dr. Rex, the D0 key can be used to play back the REX loop in the Loop Slot that currently has Note To Slot focus (see ["Note To Slot"](#)).**  
The loop is played back once (single-shot) and cannot be stopped during this time.

## Adding Loops

To add one or several (max 8) loops into the Dr. Octo Rex Loop Player, proceed as follows:

1. **Unfold the Loop Editor panel.**
2. **Select the Loop Slot you wish to add the (first) REX loop into.**



3. **Open the REX Loop browser by clicking the folder button to the left of the Loop Slot buttons.**  
Alternatively, select "Browse Loops..." from the Edit menu or the device context menu.
4. **In the Browser, locate and select the desired loop(s).**  
You can listen to the loops before loading by using the Preview function in the Browser.
  - **To select several loops, hold down [Ctrl](Win)/[Cmd](Mac) and click.**  
To select a range of loops, hold down [Shift] while clicking the last file.
5. **Click the Load button in the Browser to load the selected file(s) in the Loop Slot(s).**
  - ! If you have selected and opened several loops, the first loop will load in the selected Loop Slot and the rest will load in consecutive Loop Slots.**
  - ! Loading new REX files will replace any files currently in the slots.**
  - **Alternatively, select the REX loop(s) in the Browser and drag and drop it/them on the Loop Editor panel section, or on a Loop Slot button on the Controller Panel.**  
If you have selected several loops, the first loop will load in the selected Loop Slot and the rest will load in consecutive Loop Slots.
  - ! If you drag a single REX loop from the Browser and drop on the Controller Panel (not on a Loop Slot button), the REX loop will load into Slot 1 and all other Slots will be cleared.**

## Loading Loops “On the Fly”

Another practical method for checking out loops, is to load them “on the fly”, i.e. during playback. This is especially useful if you want to check out a number of loops against other sequencer data and patterns previously recorded. Proceed as follows:

- 1. Activate the Enable Loop Playback button on the Dr. Octo Rex device and start sequencer playback.**  
The REX loops and the sequencer are synced.
  - 2. Now load a new REX file by using the Browser in one of the usual ways.**  
After a brief silence, the new file is loaded, and sync is maintained.
  - 3. Repeat step 2 as necessary until you have found a suitable loop.**
- **If you are trying out loops within the same folder, the quickest ways to select and load a new loop is to use the arrow buttons next to the loop name display.**  
Or, you can click in the loop name display and select a new loop from the pop-up menu that appears.

## Removing Loops

- **To remove a loop from a Loop Slot, select “Remove Loop” from the Edit menu or device panel context menu.**

## Cut/Copy and Paste Loops between Loop Slots

To cut or copy a loop from one Loop Slot and paste into another, proceed as follows:

- 1. Click the button of the Loop Slot that contains the loop you want to cut or copy.**
  - 2. Select “Cut Loop” or “Copy Loop” from the Edit menu or panel context menu.**
- ! You have to context-click on the panel (not any button or knob) to access the correct context menu.**
- 3. Click the destination Loop Slot button and select “Paste Loop” from the Edit menu or panel context menu.**  
Now, you can edit the slices of the pasted loop as desired, see [“Slice handling”](#).

## Playing individual Loop Slices

Besides playing back entire REX Loops using the Run function (or Play in the sequencer), it's also possible to play individual slices of a loop from a MIDI master keyboard. This way you can use the Dr. Octo Rex almost like a traditional sampler, playing separate slices from separate keys.

The slices are automatically distributed in semitone steps, with the first slice on MIDI note C1, the second slice on C#1 and so on, with one note for each slice. The note range differs depending on how many slices the REX Loop contains.

- **Define which REX Loop to control from the MIDI master keyboard by selecting the desired Loop Slot with the Note To Slot knob:**



The range is 1-8 corresponding to Loop Slots 1-8. Selected Slot is indicated with a lit LED.



# Creating sequencer notes

The individual slices in a REX loop can be transferred as separate MIDI notes to tracks in the sequencer. This makes it possible to have detailed control over every single sample in a REX loop. Proceed as follows to create sequencer notes from the slices:

1. **Select the sequencer track associated with the Dr. Octo Rex device.**
2. **Set the left and right locators to encompass the section you want to fill with REX notes.**
3. **Select the Loop Slot that contains the REX loop you want to copy to the sequencer track.**
4. **Click the Copy Loop To Track button.**



Now, the program will create clips containing a note for each slice of the REX loop in the selected Loop Slot, positioned according to the timing of the slices. The notes will be distributed in semitone steps, with the first note on C1, the second on C#1 and so on, with one note for each slice.

In addition to the created notes, the Note To Slot parameter (see "Note To Slot") is copied into the clips as a Performance Controller. This way, Dr. Octo Rex will always know which Note Slot the generated notes originated from and will thus automatically play back the loop slices from the correct Loop Slot.



*The loop clips in the Song View...*

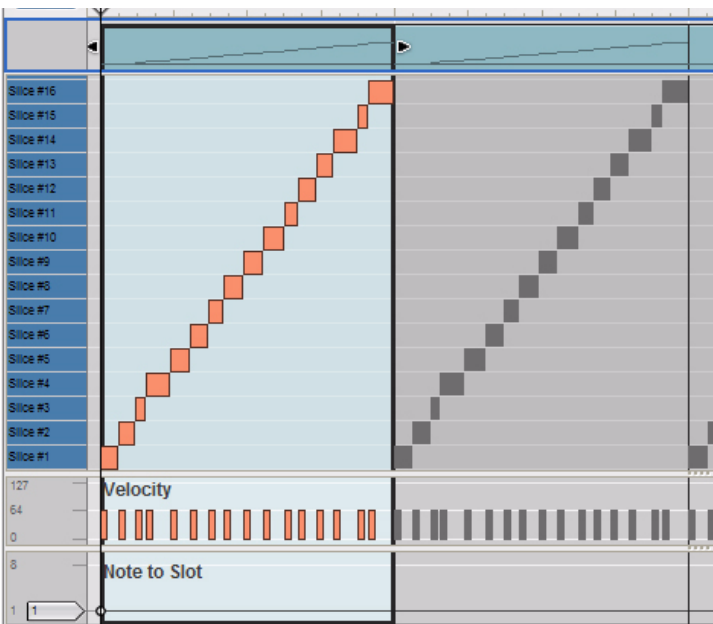

*...and in the Edit Mode, with the Note To Slot parameter as a Performance Controller at the bottom.*

## 5. Disable the Enable Loop Playback parameter.



This is because you probably don't want the loop playback to be controlled by the regular Run function but from note playback in the sequencer. If the Enable Loop Playback parameter is on, there will be double notes during playback from the sequencer.

Activating playback in the sequencer will now play back the notes on the sequencer track. These in turn will play back the slices of the REX loop in the Loop Slot defined by the Note To Slot parameter, in the correct order and with the original timing maintained. Now the fun begins!

- **If the space between the Left and Right locators is greater than the length of the REX loop, the clips will be repeated on the note lane.**



The REX loop is 1 bar long and the space between the locators is 4 bars, thus the clip is repeated four times on the note lane.

- **The Copy Loop To Track function always creates an exact number of complete clips, meaning that the last clip may “stick out” after the right locator.**

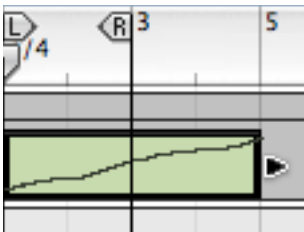

Here, the REX loop is 4 bars long. Since there are only two bars between the locators, the clip will stick out after the right locator.

- ! **If you are using the Alt function for slices in the REX loop, these slices will output different note numbers each time you use the Copy Notes To Track function. See “About the Alt parameter” for details.**
- **If you like, you can manually resize the clip to two bars by clicking and dragging the right clip handle. The last two bars of the clip will then be masked and won't play (see “Resizing (masking) clips”).**
- **You can change the groove in the loop by quantizing or moving notes.**
- **You can transpose notes to change the order of the slices on playback.**
- **You can use the Alter Notes function (see “Moving notes with the “Alter Notes” function”) to scramble the loop notes - without destroying the original loop timing.**
- **You can remove and draw new notes, creating any kind of variation.**
- **You can use the User Groove function to apply the rhythmic feel of the loop to notes on other sequencer tracks.**

For details about editing in the sequencer, see the “Note and Automation Editing” chapter.

**! Note that if you have created sequencer notes from a REX file in one Loop Slot, selecting another Loop Slot with another REX loop could make the playback sound awkward. This is because the notes generated from the original REX loop will in most situations not correspond to the slices in the other REX loops. However, in some situations this could produce really interesting results so don't be afraid to experiment.**

- **You can automate Loop Slot selection using the Notes To Slot function, see [“Note To Slot”](#).**

You can also export the REX file as a MIDI file, as described in [“Export REX as MIDI File...”](#).

# Slice handling

## Selecting Slices



A selected slice is indicated by being highlighted in the waveform display. To select a slice, use one of the following methods:

→ **By clicking in the waveform display.**

If you hold down [Alt](Win) or [Option](Mac) and click on a slice in the waveform display, it will be played back. The pointer takes on the shape of a speaker symbol to indicate this.

→ **By using the “Slice” knob below the waveform display.**

→ **Via MIDI.**

If you activate “Select Slice Via MIDI”, you can select and “play” slices using your MIDI keyboard. Slices are always mapped to consecutive semitone steps, with the first slice always being on the “C1” key.

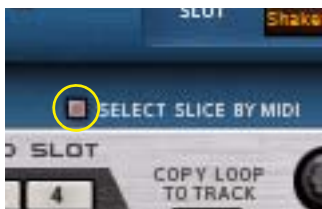

→ **If you play back a loop with “Select Slice via MIDI” option activated, each consecutive slice is selected in the waveform display as you play the keys.**

You can edit parameters during playback.

## Editing individual Slices

There are two basic methods you can use to edit individual slices in Reason:

• **In the Waveform display of the Dr. Octo Rex device.**

This is used for making playback settings for a slice.

• **In the Sequencer.**

Here you can edit the notes that play the slices. There is a special REX edit lane for editing REX slice notes, with the notes indicated by the slice numbers instead of by pitches. Editing notes in the sequencer is described in the [“Note and Automation Editing”](#) chapter.

## Editing in the Waveform Display



Here you are able to edit several parameters for each slice, by first selecting the slice and then using the knobs below the waveform display. If you want to edit a single parameter for several slices at once, a more convenient way would be to use the Slice Edit Mode, see [“The Slice Edit Mode”](#). The following slice parameters can be set:

Parameter	Description
Pitch	Allows you to transpose each individual slice in semitone steps, over a range of more than eight octaves.
Pan	The stereo position of each slice.
Level	The volume of each slice. The default level is 100.
Decay	Allows you to shorten individual slices.
Rev	Allows you to play back individual slices reversed (backwards)
F.Freq	Allows you to modify the Filter (cutoff) Frequency of individual slices. This value is added to, or subtracted (if negative) from the FREQ value of the synth panel, see <a href="#">“Filter Frequency”</a> .
Alt	Allows you to assign slices to an Alternate group (1-4). Slices assigned to any of these four Alt groups will be played back in a random fashion within each group, see <a href="#">“About the Alt parameter”</a> .
Output	Allows you to assign individual slices to separate audio outputs (1-8). If the REX loop is in stereo, there is also an option to select individual output pairs (1+2, 3+4, 5+6 or 7+8) for individual slices.

**! If you have made settings to any of the parameters listed above, these will be lost if you load a new REX file into that Loop Slot.**

### About the Alt parameter

The Alt parameter in the waveform display can be used to create a more “live” feel to your Rex loops by alternating samples within each individual Alt group. For example, if you assign all snare hit slices in the loop to the Alt 1 group, the snare samples will be selected and played back randomly each time these slices appear in the loop. Then, you could assign all hi-hat slices to the Alt 2 group and so on. The result will be a loop that plays back differently every cycle.

In the example below, slices 3 and 6 have been assigned to the same Alt group. Here, we have used the Copy Loop To Track function five times to generate notes from the loop slices, just so you can see the note distribution. As you can see, slices 3 and 6 have been distributed randomly for each loop cycle:

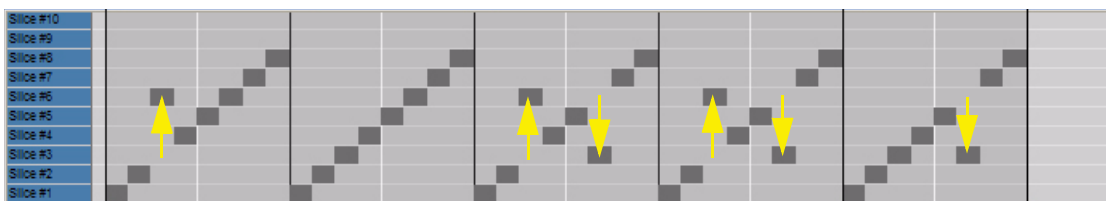

This randomization within each Alt group also occurs when you play back the REX loop using the Run function - and when you use Pattern Automation in the main sequencer.

## The Slice Edit Mode

A very convenient way of editing several slices at once is to work in Slice Edit Mode. In Slice Edit Mode, you can edit one parameter at a time for all slices in the loop.

1. Click the Edit Slice Mode button.



The waveform display switches to show the REX loop in Slice Edit Mode.

2. Select the parameter you want to edit by clicking on its name below the REX loop.

The parameters that can be selected are: Pitch, Pan, Level, Decay, Reverse, Filter Frequency, Alt Group and Output.



Here, we have selected the Pitch parameter.

3. Edit the Pitch value for each individual slice by clicking, or drawing across several slices, in the display.



Now, the Pitch parameter can be edited for all slices in a single sweep.

- To reset the selected parameter to its default value for one or several slices, hold down [Ctrl](Win) or [Cmd](Mac) and click on the desired slice(s), or draw across the slices in the waveform display.
4. When you are finished with one parameter, select another parameter and repeat the procedure by drawing values for the slices in the waveform display.
- ! If you have made settings to any of the parameters listed above, these will be lost if you load a new REX file into that Loop Slot.

# Dr. Octo Rex panel parameters

## Pitch and Mod wheels



The Pitch wheel to the left is used for “bending” the pitch up or down. The Mod wheel can be used to apply various modulation while you are playing the loop(s). Virtually all MIDI keyboards have Pitch Bend and Modulation controls. Dr. Octo Rex also has two “wheels” on the panel that could be used to apply real time modulation and pitch bend should you not have these controllers on your keyboard, or if you aren’t using a keyboard at all. The wheels mirror the movements of the corresponding MIDI keyboard controllers.

The Pitch bend range and Mod destination parameters are set on the synth parameter panel, see [“Pitch Bend Range”](#) and [“Mod. Wheel”](#).

## Trig Next Loop



The Trig Next Loop parameter determines the timing when switching between Loop Slots See [“The Trig Next Loop function”](#).

## Note To Slot



*The Notes To Slot knob set to Slot 1*

The Note To Slot knob controls which Loop Slot is currently controlled from the MIDI master keyboard, or by any recorded sequencer notes. The Loop Slot which currently has “note input” is indicated with a lit LED.

The Note To Slot parameter can also be automated. This means you could switch between Loop Slots for every single sequencer note if you like. This opens up for very interesting “beat mangling” experiments. In the example below the Note To Slot parameter has been automated to switch between the REX loops in the five first Loop Slots:

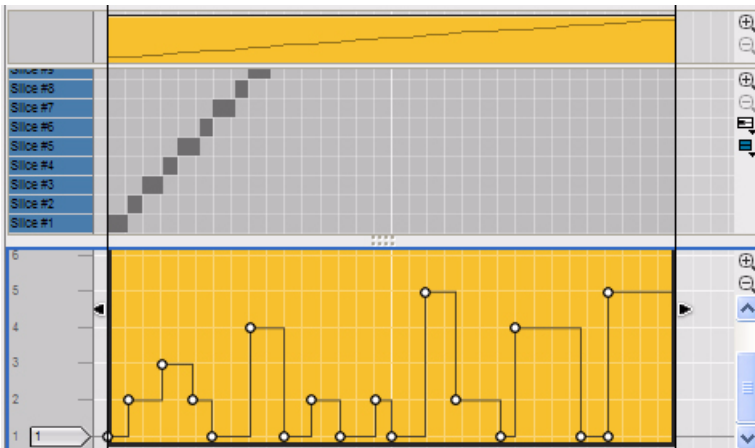

*Automation of the Note To Slot parameter to automatically switch between Loop Slots*

In the picture above slice 1 is played from Loop Slot 1, slices 2 and 3 from Loop Slot 2, slice 4 and 5 from Loop Slot 3, slice 6 from Loop Slot 2 and so on.

## Loop Slot buttons



The eight Loop Slot buttons are located in the center of the front panel. You can load one REX loop per Slot. Loading REX loops are done from the Loop Editor panel, see “[Select Loop & Load Slot](#)”.

- **Click a Loop Slot button to select its REX loop for playback.**  
Play back the REX loop in the selected Loop Slot by clicking the Run button (or Play in the main sequencer).
- ! **Note that selecting a Loop Slot only selects the corresponding REX loop for playback using the Run function (see “[Enable Loop Playback and Run](#)”) or Play from the main sequencer. Which Loop Slot the master keyboard or sequencer notes control is defined with the Note To Slot button, see “[Note To Slot](#)”.**



## Enable Loop Playback and Run



- **Click the Enable Loop Playback button to make it possible to play back the REX loops using the Run button or Play function in the main sequencer.**

If the Enable Loop Playback button is off, clicking Run or Play in the sequencer won't play back the loops. This can be useful if you only want to control the individual slices of the REX loops from a master keyboard or from recorded notes in the main sequencer.

## Volume



The Master Volume parameter acts as a general volume control for the loops in all Loop Slots.

## Global Transpose



Set the global transposition of the loops in all Loop Slots by using the Global Transpose spin control. You can raise or lower the pitch in 12 semitone steps (+/- 1 octave).

# Dr. Octo Rex synth parameters

The Dr. Octo Rex synth parameters are used for shaping and modulating the sound of the REX loops. These parameters are familiar synth parameters, similar to the ones in the synthesizers; The Subtractor and the Malström, and in the samplers; the NN-19 and the NN-XT. It is important to remember that these parameters do not alter the REX files in any way, only the way they will play back.

- ! **Most of the synth parameters are global, in the sense that they will affect all slices in the REX files as well as all REX loops in all eight Loop Slots.**
- ! **All Dr. Octo Rex synth panel settings are stored in the Song (and in the Dr. Octo Rex patch file if you choose to save the settings as a patch).**

## Select Loop & Load Slot



- **Click any of the eight Select Loop & Load Slot buttons to select a loaded REX loop for editing, or to load a new REX file to.**

If no loop is already present in the selected Loop Slot, the Waveform Display will be blank. Otherwise, the display shows a graphical readout of the REX loop and info (name, original loop tempo, number of bars and signature).

- **Click the Follow Loop Playback button to “synchronize” the Select Loop & Load Slot buttons to the Loop Slot buttons on the front panel.**

This way, the currently playing loop will always be displayed in the Waveform Display. If you're using Pattern Automation in the sequencer, where the Slots are switched during playback, you might want to deactivate the Follow Loop Playback function to make it easier to edit a specific loop.

Refer to [“Adding Loops”](#) for info on how to load REX files and to [“Editing in the Waveform Display”](#) for info about editing the REX loop.

## Loop Transpose



- **Set the transposition of individual loops in the Dr. Octo Rex by using the Loop Transpose knob to the bottom left on the panel, or by clicking on the keyboard display below the knob.**

You can raise or lower the pitch in 12 semitone steps (+/-1 octave).

- **The Loop Transpose value can also be controlled via MIDI, by pressing a key between C-2 and C0 (with C-1 re-setting the transpose value to zero).**  
This way you can also record transposition changes in the sequencer.
- ! **To control Loop Transpose via MIDI, the Note To Slot parameter must be set to the Loop Slot you want to control, see “Note To Slot”.**
- **It’s also possible to set a global transpose value that affects all REX loops equally, see “Global Transpose”.**

## Loop Level

- **Set the individual levels for the loops in the Loop Slots with the Loop Level knob.**  
This lets you match the levels of the loops in the 8 Loop Slots.

## Oscillator section



For a REX file, the audio contained in the slices are what oscillators are for a synthesizer, the main sound source. The following settings can be made in the Osc Pitch section of the Dr. Octo Rex:

### Env. A

This parameter determines to what degree the overall pitch of all the REX files will be affected by the Filter Envelope (see “Filter Envelope”). You can set negative or positive values here, which determines whether the envelope curve should raise or lower the pitch.

### Oct and Fine - Setting the overall Pitch

You can change the overall pitch of all REX files in the 8 Loop Slots in three ways:

- **In octave steps.**  
This is done using the Oct knob. The range is 0 - 8, with “4” as default.
- **In semitone steps.**  
This is done by using Global Transpose controls, see “Global Transpose”.
- **In cents (hundredths of a semitone).**  
The range is -50 to 50 (down or up half a semitone).
- **To transpose individual REX loops, use the Loop Transpose parameter, see “Loop Transpose”.**
- ! **To tune an individual slice in a REX loop, select it and use the Pitch parameter below the waveform display, see “Editing in the Waveform Display”.**

## Mod. Wheel



The Modulation wheel can be set to simultaneously control a number of parameters. You can set positive or negative values, just like in the Velocity Control section. The following parameters can be affected by the modulation wheel:

Parameter	Description
F. Freq	This sets modulation wheel control of the filter frequency parameter. A positive value will raise the frequency if the wheel is pushed forward. Negative values invert this relationship.
F. Res	This sets modulation wheel control of the filter resonance parameter. A positive value will increase the resonance if the wheel is pushed forward. Negative values invert this relationship.
F. Decay	This sets modulation wheel control for the Filter Envelope Decay parameter. A positive value will increase the decay if the wheel is pushed forward. Negative values invert this relationship.

## Velocity section



Velocity is usually used to control various parameters according to how hard or soft you play notes on your keyboard. A REX file does not contain velocity values on its own. And when you create sequencer track data by applying the “Copy Loop To Track” function, all velocities are set to a default value of “64”. As velocity information is meant to reflect variation, having them all set to the same value is not meaningful if you wish to velocity control Dr. Octo Rex parameters.

There are basically two ways you can apply “meaningful” velocity values to REX files:

- **After creating track data, you can edit velocity values in the Velocity Lane in the sequencer.**
- **You can play slices in real time on your keyboard. The resulting data will have velocity values reflecting how the notes were struck when you played.**

When velocity values have been adjusted, you can control how much the various parameters will be affected by velocity. The velocity sensitivity amount can be set to either positive or negative values, with the center position representing no velocity control.

The following parameters can be velocity controlled:

Parameter	Description
F. Env	This sets velocity control for the Filter Envelope Amount parameter. A positive value will increase the envelope amount with higher velocity values. Negative values invert this relationship.
F. Decay	This sets velocity control for the Filter Envelope Decay parameter. A positive value will increase the Decay time with higher velocity values. Negative values invert this relationship.
Amp	This lets you velocity control the overall volume of the file. If a positive value is set, the volume will increase with higher velocity values.

## The Filter Section



Filters are used for shaping the overall timbre of all REX files in all 8 Loop Slots. The filter in Dr. Octo Rex is a multi-mode filter with five filter modes.

- **Activate or deactivate the filter completely by clicking the Filter On button.**  
The filter is active when the button is lit.

### Mode

With this selector you can set the filter to operate as one of five different types of filter. These are as follows:

- **Notch**  
A notch filter (or band reject filter) could be described as the opposite of a bandpass filter. It cuts off frequencies in a narrow midrange band, letting the frequencies below and above through.
- **High-Pass (HP12)**  
A highpass filter is the opposite of a lowpass filter, cutting out lower frequencies and letting high frequencies pass. The HP filter slope has a 12 dB/Octave roll-off.
- **Bandpass (BP 12)**  
A bandpass filter cuts both high and low frequencies, while midrange frequencies are not affected. Each slope in this filter type has a 12 dB/Octave roll-off.
- **12 dB Lowpass (LP 12)**  
This type of lowpass filter is also widely used in classic analog synthesizers (Oberheim, early Korg synths, etc.). It has a gentler slope (12 dB/Octave), leaving more of the harmonics in the filtered sound compared to the LP 24 filter.
- **24 dB Lowpass (LP 24)**  
Lowpass filters let low frequencies pass and cut out the high frequencies. This filter type has a fairly steep roll-off curve (24dB/Octave). Many classic synthesizers (Minimoog/Prophet 5 etc.) used this filter type.

### Filter Frequency

The Filter Frequency parameter (often referred to as “cutoff”) determines which area of the frequency spectrum the filter will operate in. For a lowpass filter, the frequency parameter could be described as governing the “opening” and “closing” of the filter. If the Filter Freq is set to zero, none or only the very lowest frequencies are heard, if set to maximum, all frequencies in the waveform are heard. Gradually changing the Filter Frequency produces the classic synthesizer filter “sweep” sound.

- ! **Note that the Filter Frequency parameter is usually controlled by the Filter Envelope (see “Filter Envelope”) as well. Changing the Filter Frequency with the Freq slider may therefore not produce the expected result.**

## Resonance

The filter resonance parameter affects the character of the filter sound. For lowpass filters, raising the resonance will emphasize the frequencies around the set filter frequency. This produces a generally thinner sound, but with a sharper, more pronounced filter frequency "sweep". The higher the resonance value, the more resonant the sound becomes until it produces a whistling or ringing sound. If you set a high value for the resonance parameter and then vary the filter frequency, this will produce a very distinct sweep, with the ringing sound being very evident at certain frequencies.

- **For the highpass filter, the resonance parameter operates just like for the lowpass filters.**
- **When you use the Bandpass or Notch filter, the resonance setting adjusts the width of the band.**  
When you raise the resonance, the band where frequencies are let through (Bandpass), or cut (Notch) will become narrower. Generally, the Notch filter produces more musical results using low resonance settings.

## Envelope section

Envelope generators are used to control several important sound parameters in analog synthesizers, such as pitch, volume, filter frequency etc. In a conventional synthesizer, envelopes govern how these parameters should respond over time - from the moment a note is struck to the moment it is released. In the Dr. Octo Rex device however, the envelopes are triggered each time a slice is played back.

There are two envelope generators in the Dr. Octo Rex, one for volume, and one for the filter frequency (and/or pitch). Both have the standard four parameters; Attack, Decay, Sustain and Release

! **Please refer to "Envelopes - General" in the Subtractor chapter for a description of the basic envelope parameters.**

## Amplitude Envelope

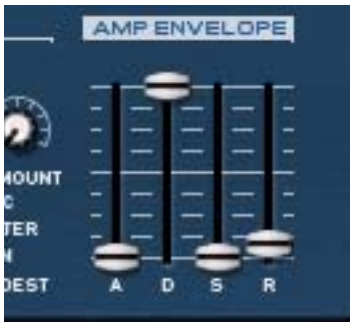

The Amp Envelope governs how the volume of each slice should change over time, from the time it is triggered (the slice note starts) until the slice note ends. This can be used to make a loop more distinct (by having a snappy attack and a short decay time) or more spaced-out (by raising the attack time).

## Filter Envelope

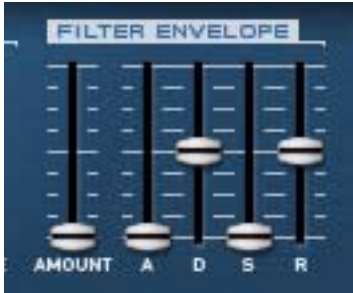

The Filter Envelope can be used to control two parameters for all REX loops in the 8 Loop Slots; filter frequency and overall loop pitch. By setting up a filter envelope you control how the filter frequency and/or the pitch should change over time for each slice.

The Amount parameter determines to what degree the filter frequency will be affected by the Filter Envelope. The higher the Amount setting, the more pronounced the effect of the envelope on the filter.

- Try lowering the Frequency slider and raising Resonance and Envelope Amount to get the most effect of the filter envelope!

## LFO section



LFO stands for Low Frequency Oscillator. LFOs are oscillators in the sense that they generate a waveform and a frequency. However, there are two significant differences compared to normal sound generating oscillators:

- **LFOs only generate waveforms with low frequencies.**
- **The output of the two LFOs are never actually heard. Instead they are used for modulating various parameters.**

The most typical application of an LFO is to modulate the pitch of a (sound generating) oscillator or sample, to produce vibrato. In the Dr. Octo Rex device, you can also use the LFO to modulate the filter frequency or panning.

## Waveform

LFO 1 allows you to select different waveforms for modulating parameters. These are, from top to bottom:

Waveform	Description
Triangle	This is a smooth waveform, suitable for normal vibrato.
Inverted Sawtooth	This produces a "ramp up" cycle. If set to control pitch (frequency), the pitch would sweep up to a set point (governed by the Amount setting), after which the cycle immediately starts over.
Sawtooth	This produces a "ramp down" cycle, the same as above but inverted.
Square	This produces cycles that abruptly changes between two values, usable for trills etc.
Random	Produces random stepped modulation to the destination. Some vintage analog synths called this feature "sample & hold".
Soft Random	The same as above, but with smooth modulation.

## Destination

The available LFO Destinations are as follows:

Destination	Description
Osc	Selecting this makes LFO control the pitch (frequency) of the REX file.
Filter	Selecting this makes the LFO control the filter frequency.
Pan	Selecting this makes the LFO modulate the pan position of the REX file, i.e. it will move the sound from left to right in the stereo field.

## Sync

By clicking the SYNC button you activate/deactivate LFO sync. The frequency of the LFO will then be synchronized to the song tempo, in one of 16 possible time divisions. When sync is activated, the Rate knob (see below) is used for setting the desired time division.

Turn the knob and check the tooltip for an indication of the time division.



## Rate

The Rate knob controls the LFO's frequency. Turn clockwise for a faster modulation rate.

## Amount

This parameter determines to what degree the selected parameter destination will be affected by the LFO 1, i.e. the amount of vibrato, filter wah or auto-panning.

## Pitch Bend Range



The Pitch Bend Range parameter sets the amount of pitch bend when the wheel is turned fully up or down. The maximum range is 24 semitones (=up/down 2 Octaves).



## Setting number of voices - polyphony



This determines the polyphony, i.e. the number of voices, or slices, Dr. Octo Rex can play simultaneously. For normal loop playback, it is worth noting that slices sometimes “overlap”. Therefore, it is recommended that you use a polyphony setting of about 3-4 voices when playing REX files. If you are “playing” slices via MIDI, the polyphony setting should be set according to how many overlapping slices you want to have.

**! Note that the Polyphony setting does not “hog” voices. For example, if you are playing a file that has a polyphony setting of ten voices, but the file only uses four voices, this doesn’t mean that you are “wasting” six voices. In other words, the polyphony setting is not something you need to consider if you want to conserve CPU power - it is only the number of voices actually used that counts.**

## Audio Quality settings

Dr. Octo Rex features two parameters that provide ways of balancing audio quality vs. conservation of computer power. The parameters are called “High Quality Interpolation” and “Low Bandwidth” and are located to the right on the rear panel:



### High Quality Interpolation

When High Quality Interpolation is active, the loop file playback is calculated using a more advanced interpolation algorithm. This results in better audio quality, especially for loops with a lot of high frequency content.

- **High Quality Interpolation uses more computer power - if you don’t need it, it’s a good idea to turn it off.**  
Listen to the loop in a context and determine whether you think this setting makes any difference.

### Low Bandwidth

This will remove some high frequency content from the sound, but often this is not noticeable (this is especially true if you have “filtered down” your loop). Activating this mode will save you some extra computer power, if needed.

## Connections



On the rear panel of Dr. Octo Rex you will find the connectors. The left part of the panel houses a number of CV/Gate inputs and outputs. Using CV/Gate is described in [“Routing Audio and CV”](#).

## Modulation Inputs

These control voltage (CV) inputs (with trim pots), allow you to modulate various Dr. Octo Rex parameters from other devices (or from the modulation outputs of the Dr. Octo Rex device itself). The following CV inputs are available:

- **Master Volume**
- **Mod Wheel**
- **Pitch Wheel**
- **Filter Cutoff**
- **Filter Resonance**
- **Osc Pitch**

## Modulation Outputs

The Modulation outputs can be used to voltage control other devices, or other parameters in the Dr. Octo Rex device itself. The Modulation Outputs are:

- **Filter Envelope**  
The Filter Envelopes in Dr. Octo Rex are polyphonic (one per voice). Only the filter envelope of voice 1 is output here.
- **LFO**

## Gate Inputs

These inputs can receive a CV/gate signal to trigger the two envelopes. Note that connecting to these inputs will override the “normal” triggering of the envelopes. For example, if you connected an LFO CV output on another device to the Gate Amp input on the Dr. Octo Rex, the amplitude envelope would not be triggered by the incoming MIDI notes to the Dr. Octo Rex device, but by the LFO CV signal. In addition you would only hear the LFO triggering the envelope for the slices that were playing at the moment of the trigger.

- **Amp Envelope**
- **Filter Envelope**

## Gate Output

This outputs a gate signal for each triggered slice in the loop.

## Slice Outputs

To the right of the modulation inputs and outputs are the eight individual slice audio outputs. You can assign individual slices to any of these outputs as described in [“Editing in the Waveform Display”](#).

## Main Outputs

To the right are the main left and right audio outputs. When you create a new Dr. Octo Rex device, these are auto-routed to the first available channel on the audio mixer.

**Chapter 35**  
**Redrum Drum**  
**Computer**

# Introduction



At first glance, Redrum looks styled after pattern-based drum machines, like the legendary Roland 808/909 units. Indeed, it does have a row of 16 step buttons that are used for step programming patterns, just like the aforementioned classics. There are significant differences, however. Redrum features ten drum “channels” that can each be loaded with an audio file, allowing for completely open-ended sound possibilities. Don't like the snare - just change it. Complete drum kits can be saved as Redrum Patches, allowing you to mix and match drum sounds and make up custom kits with ease.

In addition, Redrum also has sampling capability. This means that you can sample your own sounds straight into each of the ten drum channels with just a click of a button!

## Sampling in Redrum

The sampling procedure is generic for all devices that can sample (NN-19, NN-XT, Redrum and Kong). The sampling and sample editing procedures are described in detail in the “[Sampling](#)” chapter.

- **To sample your own sound and automatically load it into a drum channel in the Redrum device, click the Sample button for the desired drum channel.**



Refer to the “[Sampling](#)” chapter for details on how to set up and use the sampling feature.

# About file formats

Redrum reads two basic types of files:

## Redrum Patches

A Redrum patch (Windows extension “.drp”) contains all settings for all ten drum sound channels, including file references to the used drum samples (but not the actual drum samples themselves). Switching patches is the same as selecting a new drum kit.

## Drum Samples

The audio file format support differs depending on which computer OS you are using.

Redrum can read audio files in the following formats:

- **In Windows 7:**  
.wav, .aif, .mp3, .aac, .m4a and .wma.
- **In Mac OSX 10.7:**  
.wav, .aiff, .3g2, .3gp, .mp1, .mp2, .mp3, .mpeg, .mpa, .snd, .au, .sd2, .ac3, .aac, .adts, .amr, .caf, .m4a .m4r and .mp4.
- **SoundFonts (.sf2)**  
SoundFonts are an open standard for wavetable synthesized audio, developed by E-mu systems and Creative Technologies.
- **REX file slices (.rx2, .rex, .rcy)**  
REX files are music loops created in the ReCycle program or when editing audio clips inline in Reason (see [“Bounce Clip to REX Loop”](#)). Redrum lets you load separate slices from REX files as individual samples.
- **Any sample rate and practically any bit depth.**

# Using patches

When you create a new Redrum device it is loaded with a default kit. If you like you can program a pattern and play back using the default kit - or you can load another Redrum patch (or create one from scratch, by loading individual drum samples). A Redrum patch contains settings for the ten drum sound channels, complete with file references to the drum samples used.

! **Redrum patterns are not part of the patch! If you want to save Redrum patches complete with patterns, create a Combinator containing the Redrum and save the Combi patch.**

## Loading a patch

To load a patch, use one of the following methods:

→ **Use the Browser to locate and load the desired patch.**

To open the browser and set browse focus to the Redrum device, select "Browse Redrum Patches" from the Edit menu or device context menu, or click the folder button in the patch section on the device panel.



- **Once you have selected a patch, you can step between all the patches in the same folder by using the arrow buttons next to the patch name display.**
- **If you click on the patch name display on the device panel, a pop-up menu will appear, listing all patches in the current folder.**  
This allows you to quickly select another patch in the same folder, without having to step through each one in turn.
- **Drag a Redrum (.drp) patch from the Browser and drop on the device panel.**  
The panel is dimmed in orange and a Patch Replace symbol appears in the center.

## Checking the sounds in a patch

There are two ways you can listen to the sounds in a patch without programming a pattern:

→ **By clicking the Trigger (arrow) button at the top of each drum sound channel.**



→ **By playing the keys C1 to A1 on your MIDI keyboard.**

C1 plays drum sound channel 1 and so on. See also "Using Redrum as a sound module".

Both these methods play back the drum sample for the corresponding drum sound channel, with all settings for the sound applied.

## Creating a new patch

To create a patch of your own (or modify an existing patch), you use the following basic steps:

**1. Click the folder button for a drum sound channel.**

The Redrum sample browser opens.



**2. Locate and load a drum sample.**

You will find a large number of drum samples in the Factory Sound Bank (in the folder Redrum Drum Kits/xclusive drums-sorted). You can also load other samples in any supported format.

→ **Alternatively, drag a sample file from the Browser and drop on the desired sound channel section.**

The sound channel is dimmed in blue and a Sample Replace symbol appears in the center.

**3. Make the desired settings for the drum sound channel.**

The parameters are described in [“Redrum parameters”](#).

**4. Repeat steps 1 and 3 for the other drum sound channels.**

**5. When you're satisfied with the drum kit, you can save the patch by clicking the Floppy Disk button in the patch section on the device panel.**

Note however, that you don't necessarily need to save the patch - all settings are included when you save the song.

## Loading REX file slices

Loading slices from within a REX file is done much in the same way as loading “regular” samples:

**1. Open the Browser as described above.**

**2. Browse to a REX file.**

Possible extensions are “.rx2”, “.rex” and “.rcy”.

**3. Unfold the REX file.**

The browser will now display a list of all the separate slices within the REX file.

**4. Select the desired slice and click the Load button in the Browser.**

The slice is loaded into the Redrum.

→ **Alternatively, drag a REX slice file from the Browser and drop on the desired sound channel section.**

The sound channel is dimmed in blue and a Sample Replace symbol appears in the center.

## Creating an empty patch

To “initialize” the settings in the Redrum, select “Reset Device” from the Edit menu or the device context menu. This removes all samples for all drum sound channels, and sets all parameters to their default values.

# Programming patterns

## Pattern basics

Redrum contains a built-in pattern sequencer. Unlike the main sequencer in Reason, the Redrum sequencer repeatedly plays back a pattern of a specified length. The typical analogy in the “real world” is a drum machine which plays drum patterns, usually one or two bars in length.

Having the same pattern repeat throughout a whole song may be fine in some cases, but most often you want some variations. The solution is to create several different patterns and program pattern changes (automatic switching from one pattern to another) at the desired positions in the song.

## How the Redrum pattern sequencer integrates with the main sequencer

The built-in pattern sequencer in the Redrum interacts with the main Reason sequencer in the following ways:

→ **The tempo set on the transport panel is used for all playback.**

If the Tempo track (see “Recording tempo automation”) is used, Redrum will follow this.

→ **If you start playback for the main sequencer (on the transport panel), the Redrum will automatically start as well (provided the pattern sequencer hasn’t been disabled - see below).**

→ **You can mute and solo Redrum tracks in the sequencer.**

If the Redrum has a track in the sequencer and you mute this track, Redrum will automatically be muted as well. This is indicated by a Mute indicator on the device panel. If there are several note lanes on the Redrum track, their respective mute status will not be indicated on the device panel.



*This Redrum device is muted.*

→ **You can also run Redrum separately (without starting the main sequencer) by clicking the Run button on the device panel.**

This starts the built-in pattern sequencer in the device. To stop playback, click the Run button again or click the Stop button on the Transport panel.



*The Run button on the Redrum.*

→ **If you are running Redrum separately and start playback of the main sequencer, the pattern device will automatically restart in sync with the sequencer.**



→ **Pattern changes can be controlled by pattern change events in the main sequencer.**

In other words, you can record or create pattern changes in the main sequencer, and have them occur at the correct position on playback.

→ **The sound sources can also be played by the main sequencer, or via MIDI.**

You can combine the built-in pattern playback with playback from the main sequencer or via MIDI. For example, this allows you to add variations or fills to a basic pattern.

It is also possible to disable the pattern sequencer totally, converting the device to a pure sound module. This is done by deactivating the Enable Pattern Section switch.



## Selecting patterns

The Redrum has 32 pattern memories, divided into four banks (A, B, C, D).



*The Bank and Pattern buttons for the Redrum pattern sequencer.*

→ **To select a pattern in the current bank, click on the desired Pattern button (1-8).**

If you like, you can assign computer key commands and/or MIDI messages to pattern selection.

→ **To select a pattern in another bank, first click the desired Bank button (A, B, C, D) and then click the Pattern button.**

Nothing happens until you click the Pattern button.

→ **If you select a new pattern during playback, the change will take effect on the next downbeat (according to the time signature set in the transport panel).**

If you automate pattern changes in the main sequencer, you can make them happen at any position - see ["Recording pattern automation"](#).

→ **Note that you cannot load or save patterns - they are only stored as part of a song.**

However, you can move patterns from one location to another (even between songs) by using the Cut, Copy and Paste Pattern commands.

## Pattern tutorial

If you are unfamiliar with step programming patterns, the basic principle is very intuitive and easy to learn. Proceed as follows:

**1. Load a Redrum patch, if one isn't already loaded.**

**2. Make sure an empty pattern is selected.**

If you like, use the Clear Pattern command on the Edit menu or device context menu to make sure.

**3. Make sure that the “Enable Pattern Section” and the “Pattern” buttons are activated (lit).**



**4. Press the “Run” button.**

There will be no sound, as no pattern steps have been recorded yet. But as you can see, the LEDs over the Step button light up consecutively, moving from left to right, and then starts over. Each Step button represents one “step” in the Pattern.

**5. Select a Redrum channel, by clicking the “Select” button at the bottom of the channel.**

The button lights up, indicating that this channel and the drum sound it contains is selected.



**6. While in Run mode, press Step button 1, so that it lights up.**

The selected sound will now play every time Step 1 is “passed over”.

**7. Clicking other Step buttons so they light up will play back the selected sound as the sequencer passes those steps.**

Clicking on a selected (lit) step button a second time removes the sound from that step and the button goes dark again. You can click and drag to add or remove steps quickly.

**8. Select another Redrum channel to program steps for that sound.**

Selecting a new sound or channel also removes the visual indications (static lit buttons) of step entries for the previously selected sound. The step buttons always show step entries for the currently selected sound.

**9. Continue switching between sounds, and programming steps to build your pattern.**

Note that you can erase or add step entries even if Run mode isn't activated.

## Setting pattern length

You may want to make settings for Pattern length, i.e the number of steps the pattern should play before repeating:



→ **Use the “Steps” spin controls to set the number of steps you wish the pattern to play.**

The range is 1 to 64. You can always extend the number of steps at a later stage, as this will merely add empty steps at the end of the original pattern. You could also make it shorter, but that would (obviously) mean that the steps “outside” the new length won’t be heard. These steps aren’t erased though; if you raise the Steps value again, the steps will be played back again.

## About the “Edit Steps” Switch

If you set the pattern length to more than 16 steps, the pattern steps following after the 16th won’t be visible, although they will play back. To view and be able to edit the next 16 steps, you have to set the Edit Steps switch to 17-32. To see and edit steps beyond 32 you set the switch to 33-48, and so on.

## Setting pattern resolution



Redrum always follows the tempo setting on the transport panel, but you can also make Redrum play in different “resolutions” in relation to the tempo setting. Changing the Resolution setting changes the length of each step, and thereby the “speed” of the pattern.

## Step dynamics

When you enter step notes for a drum sound, you can set the velocity value for each step to one of three values: Hard, Medium or Soft. This is done by setting the Dynamic switch before entering the note.



*The color of the step buttons reflect the dynamics for each step. Soft notes are light yellow, Medium notes are orange and Hard are red.*

→ **When the Medium value is selected, you can enter Hard notes by holding down [Shift] and clicking.**

In the same way, you can enter Soft notes by holding down [Option] (Mac) or [Alt] (Windows) and clicking. Note that this doesn’t change the Dynamic setting on the device panel - it only affects the notes you enter.

→ **When you use different dynamics, the resulting difference in the sound (loudness, pitch, etc.), is governed by the “VEL” knob settings for each drum channel (see “Redrum parameters”).**

If no velocity amount is set for a drum channel, it will play back the same, regardless of the Dynamic setting.

→ **To change the dynamics for an already programmed step, set the switch to the dynamic value you wish to change it to and click on the step.**

! **Note that if you are triggering Redrum via MIDI or from the main sequencer, the sounds will react to velocity like any other audio device. The Dynamic values are there to offer velocity control when using the built-in pattern sequencer.**

## Pattern Shuffle

Shuffle is a rhythmic feature, that gives the music a more or less pronounced swing feel. It works by delaying all sixteenth notes that fall in between the eighth notes. You can activate or deactivate shuffle individually for each Redrum pattern by clicking the Shuffle button on the device panel.



The amount of shuffle is set globally with the Global Shuffle control in the ReGroove Mixer - see ["The ReGroove Mixer"](#).



## Flam



A flam is when you double-strike a drum, to create a rhythmic or dynamic effect. Applying flam to a step entry will add a second "hit" to a drum sound. The flam amount knob determines the delay between the two hits.

To add a flam drum note, proceed as follows:

- 1. Activate flam by clicking the Flam button.**
  - 2. Click on a step to add a note (taking the Dynamic setting into account as usual).**  
A red LED is lit above the step to indicate that flam will be applied to that step.
  - 3. Use the Flam knob to set the desired amount of flam.**  
The flam amount is global for all patterns in the device.
- **To add or remove flam to or from an existing step note, click directly on the corresponding flam LED.**  
You can also click and drag on the LEDs to add or remove several flam steps quickly.
  - **Applying flam to several consecutive step entries is a quick way to produce drum rolls.**  
By adjusting the Flam knob you can create 1/32 notes even if the step resolution is 1/16, for example.

## The Pattern Enable switch

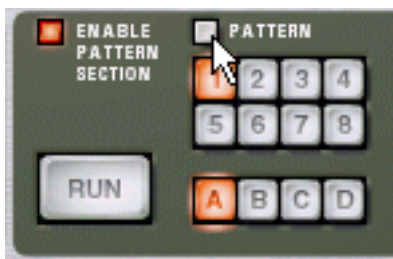

If you deactivate the “Pattern” button the pattern playback will be muted, starting at the next downbeat (exactly as if you had selected an empty (silent) pattern). For example, this can be used for bringing different pattern devices in and out of the mix during playback.

- You can also mute Redrum devices in the sequencer using the Mute button for the track connected to the Redrum. If you do so, this will mute the Redrum output instantly, and the Mute indicator on the Redrum panel lights up. Note that all tracks connected to this Redrum device must be muted for this to work.



*The Mute indicator*

## The Enable Pattern Section switch

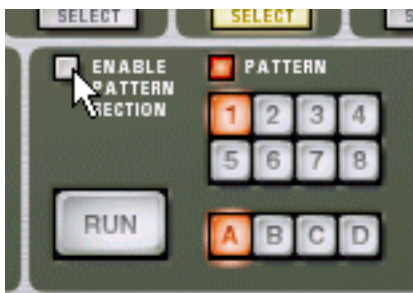

If this is off, Redrum will function as a pure “sound module”, i.e. the internal Pattern sequencer is disengaged. Use this mode if you wish to control Redrum exclusively from the main sequencer or via MIDI (see [“Using Redrum as a sound module”](#)).

## Pattern functions

When a Redrum device is selected, you will find some specific pattern functions on the Edit menu (and on the device context menu):

Function	Description
Shift Pattern Left/Right	These functions move all notes in the pattern one step to the left or right.
Shift Drum Left/Right	The Shift Drum functions move all notes for the selected drum channel (the channel for which the Select button is lit) one step to the left or right.
Randomize Pattern	Creates a random pattern. Random patterns can be great starting points and help you get new ideas.
Randomize Drum	Creates a random pattern for the selected drum sound only - the notes for the other drum sound channels are unaffected.
Alter Pattern	The Alter Pattern function modifies the selected pattern by "shuffling" the current pattern notes and redistributing them among the drum sounds at random. This creates a less chaotic pattern than the "Randomize Pattern" function. Note that there must be something in the pattern for the function to work on - using an Alter function on an empty pattern will not do anything.
Alter Drum	Works like the "Alter Pattern" function, but affects the selected drum sound only.

## Chaining patterns

When you have created several patterns that belong together, you most probably want to make these play back in a certain order. This is done by recording or inserting pattern changes into the main sequencer. See ["Recording pattern automation"](#).

## Converting Pattern data to notes in the main sequencer

You can convert Redrum Patterns to notes in the main sequencer. This allows you to edit the notes freely, create variations or use Groove quantizing.

### The “Copy Pattern to Track” function

This function is useful when you have created a single pattern in the Redrum device and want to render individual note events on the sequencer track. You could also use this if you e.g. have created a drum pattern and want to have the pattern play back some other type of device.

Proceed as follows:

**1. Set the Left and Right Locators to encompass the section you want to “fill” with the notes in the pattern.**

You may want to make sure that the space between the locators is a multiple of the pattern length, to avoid “cutting off” the pattern.

**2. Select the device in the rack and select “Copy Pattern to Track” from the Edit menu or the device context menu.**

The pattern is converted to a single note clip on the track (see the notes below). If the space between the locators is greater than the pattern length, the pattern will be repeated in the clip to fill up the space.

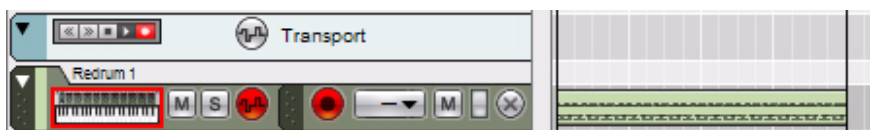

*An internal Redrum drum pattern converted to note events on the track*

When you use the “Copy Pattern to Track” function with the Redrum, you should note the following:

- **The notes will have the pitch of the corresponding drum sound (see “Using Redrum as a sound module”) and the velocity depending on the “Dynamic” parameter value in the device.**  
“Soft” notes get velocity 30, “Medium” notes get velocity 80 and “Hard” notes get velocity 127.
- **You probably want to turn off the “Enable Pattern Section” switch on the Redrum device panel.**  
Otherwise, the drum sounds will be double-triggered during playback (by the pattern section itself, and by the rendered notes on the sequencer track).



### The “Convert Pattern Automation to Notes” function

If you have recorded or drawn pattern changes on a Redrum track, you can have the whole track converted to notes, in the following way:

**1. Select the track with the pattern automation.**

**2. Select “Convert Pattern Automation to Notes” from the Edit menu or the context menu for the track.**

For each pattern clip, the corresponding pattern is converted to note clips on the track (following the same rules as for the “Copy Pattern to Track” function). The track will play back just the same as when you played the pattern device with the pattern changes.

→ **After the operation, the Pattern Select lane is switched off.**

The “Enable Pattern Section” button on the device is automatically turned off.

# Redrum parameters

## Drum sound settings

Redrum features ten drum sound channels that can each be loaded with a Wave or AIFF sample or a sample from a SoundFont bank. Although they are basically similar, there are three “types” of drum sound channels, with slightly different features. This makes some channels more suitable for certain types of drum sounds, but you are of course free to configure your drum kits as you like.

On the following pages, all parameters will be listed. If a parameter is available for certain drum sound channels only, this will be stated.

## Mute & Solo



At the top of each drum sound channel, you will find a Mute (M) and a Solo (S) button. Muting a channel silences its output, while Soloing a channel mutes all other channels. Several channels can be muted or soloed at the same time. You can also use keys on your MIDI keyboard to mute or solo individual drum sounds in real time.

- **The keys C2 to E3 (white keys only) will mute individual drum channels starting with channel 1.**  
The sounds are muted for as long as you hold the key(s) down.
- **The keys C4 to E5 (white keys only) will solo individual drum channel, starting with channel 1.**  
The sounds are soloed for as long as you hold the key(s) down.

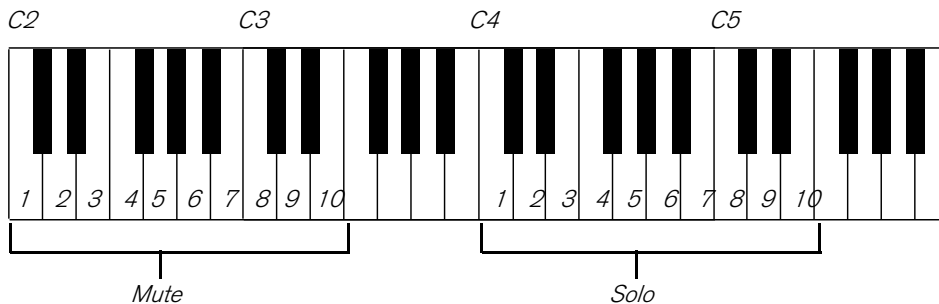

This is a great way to bring drum sounds in and out of the mix when playing Reason live. You can also record the drum channel Mutes in the main sequencer, just like any other controller (see [“Recording parameter automation”](#)).

## The Effect Sends (S1 & S2)



On the back panel of Redrum you will note two audio connections labeled “Send Out” 1 and 2. When you create a Redrum device, these will by default be auto-routed to the first two “Chaining Aux” inputs on the Mixer device (provided that these inputs aren’t already in use).

This feature allows you to add effects to independent drum sounds in the Redrum.



- **Raising the S1 knob for a drum sound channel will send the sound to the first send effect connected to the mixer.**  
Similarly, the S2 knob governs the send level to the second send effect in the mixer.
- **Note that there must be send effects connected to the AUX Sends and Returns in the mixer for this to work.**
- **Also note that if Redrum is soloed in the Mixer the effect sends will be muted.**
- **Another way to add independent effects to drum sounds is to use the independent drum outputs.**  
See “Connections”.

## Pan



Sets the Pan (stereo position) for the channel.

- **If the LED above the Pan control is lit, the sound uses a stereo sample.**  
In that case, the Pan control serves as a stereo balance control.

## Level and Velocity



The Level knob sets the volume for the channel. However, the volume can also be affected by velocity (as set with the Dynamic value, or as played via MIDI). How much the volume should be affected by velocity is set with the “Vel” knob.

- **If the Vel knob is set to a positive value, the volume will become louder with increasing velocity values.**  
The higher the Vel value, the larger the difference in volume between low and high velocity values.
- **A negative value inverts this relationship, so that the volume decreases with higher velocity values.**
- **If the Vel knob is set to zero (middle position), the sound will play at a constant volume, regardless of the velocity.**  
When Vel is set to zero, the LED above the knob goes dark.

## Length and the Decay/Gate switch



The Length knob determines the length of the drum sound, but the result depends on the setting of the Decay/Gate switch:

- **In Decay mode (switch down), the sound will decay (gradually fade out) after being triggered. The decay time is determined by the Length setting.**  
In this mode, it doesn't matter for how long a drum note is held (if played back from the main sequencer or via MIDI) - the sound will play the same length for short notes as for long notes. This is the traditional “drum machine” mode.

→ **In Gate mode (switch up), the sound will play for the set Length, and then be cut off.**

Furthermore, if a sound set to Gate mode is played from the main sequencer, from a CV/Gate device or via MIDI, the sound will be cut off when the note ends or after the set Length, depending on which comes first. Or in other words, the sound plays for as long as you hold the note, but the Length setting serves as the maximum length for the sound.

There are several uses for the Gate mode:

- **For “gated” drum sounds, when the tail of the sound is abruptly cut off as an effect.**
  - **For when you want to use very short sounds, and don’t want them to “lose power” by being faded out.**
  - **For when you play the Redrum from the sequencer or via MIDI, with sounds for which the length is important (e.g. when using the Redrum as a sound effects module).**
- ! **Audio samples sometimes contain a “loop”, which is set by editing the audio in a sample editor. This loop repeats a part of the sample to produce sustain as long as you hold down a note. Drum samples usually don’t contain loops, but who is to say that Redrum should only play drum samples?**  
**Note that if a sample contains a loop, and Length is set to maximum, the sound will have infinite sustain, in other words it will never become silent, even if you stop playback. Decreasing the Length setting solves this problem.**

## Pitch



Sets the pitch of the sound. The range is +/- 1 octave.

- **When the pitch is set to any other value than 0, the LED above the knob lights up to indicate that the sample isn’t played back at its original pitch.**

## Pitch Bend



By setting the Bend knob to a positive or negative value, you specify the start pitch of the sound (relative to the Pitch setting). The pitch of the sound will then be bent to the main Pitch value. Thus, selecting a positive Bend value will cause the pitch to start higher and bend down to the original Pitch, and vice versa.

- **The Rate knob determines the bend time - the higher the value, the slower the bend.**
  - **The Vel knob determines how the Bend amount should be affected by velocity.**  
With a positive Vel value, higher velocity results in wider pitch bends.
  - **The Bend and Vel knobs have LEDs that light up when the functions are activated (i.e. when a value other than zero is selected).**
- ! **Pitch bend is available for drum sound channels 6 and 7 only.**

## Tone



The Tone knob determines the brightness of the drum sound. Raising this parameter results in a brighter sound. The Vel knob determines whether the sound should become brighter (positive Vel value) or darker (negative Vel value) with higher velocity.

→ **The Tone and Vel knobs have LEDs that light up when the functions are activated (i.e. when a value other than zero is selected).**

! **The Tone controls are available for drum sound channels 1, 2 and 10 only.**

## Sample Start



The Start parameter allows you to adjust the start point of the sample. The higher the Start value, the further the start point is moved “into” the sample. If you set the Start Velocity knob to a positive amount, the sample start point is moved forward with higher velocities. A negative Start Velocity amount inverts this relationship.

→ **When Start Velocity is set to any other value than zero, the LED above the knob lights up.**

→ **A negative Start Velocity amount is only useful if you have set the Start parameter to a value higher than 0.**

By raising the Start value a bit and setting Start Velocity to a negative value, you can create rather realistic velocity control over some drum sounds. This is because the very first transients in the drum sound will only be heard when you play hard notes.

! **The Sample Start settings are available for drum sound channels 3-5, 8 and 9.**

## Global settings

### Channel 8 & 9 Exclusive



If this button is activated, the sounds loaded into drum channels 8 and 9 will be exclusive. In other words, if a sound is played in channel 8 it will be silenced the moment a sound is triggered in channel 9, and vice versa.

The most obvious application for this feature is to “cut off” an open hi-hat with a closed hi-hat, just like a real one does.

## High Quality Interpolation



When this is activated, the sample playback is calculated using a more advanced interpolation algorithm. This results in better audio quality, especially for drum samples with a lot of high frequency content.

→ **High Quality Interpolation uses more computer power - if you don't need it, it's a good idea to turn it off!**

Listen to the drum sounds in a context and determine whether you think this setting makes any difference.

## Master Level

The Master Level knob in the top left corner of the device panel governs the overall volume from Redrum.

## Using Redrum as a sound module

The drum sounds in Redrum can be played via MIDI notes. Each drum sound is triggered by a specific note number, starting at C1 (MIDI note number 36):

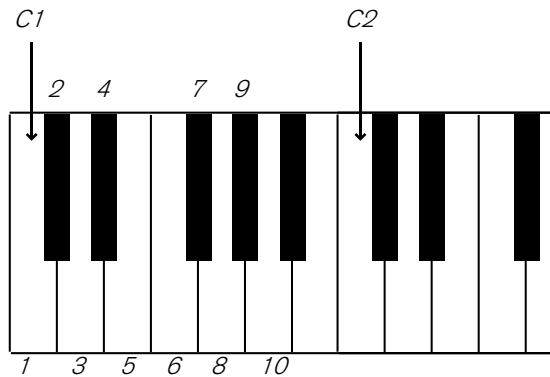

This allows you to play Redrum live from a MIDI keyboard or a MIDI percussion controller, or to record or draw drum notes in the main sequencer. If you like, you can combine pattern playback with additional drum notes, such as fills and variations. However:

**! If you want to use Redrum purely as a sound module (i.e. without pattern playback) you should make sure that the "Enable Pattern Section" button is deactivated (see "The Enable Pattern Section switch"), otherwise the Redrum pattern sequencer will start as soon as you start the main sequencer.**

# Connections



On the back of the Redrum you will find the following connections:

## For each drum sound channel:

Connection	Description
Audio Outputs	There are individual audio outputs for each drum sound channel, allowing you to route a drum sound to a separate channel in the mixer, possibly via insert effects, etc. For mono sounds, use the "Left (Mono)" output (and pan the sound using the Pan control in the mixer). When you use an individual output for a sound, the sound is automatically excluded from the master stereo output.
Gate Out	This sends out a gate signal when the drum sound is played (from a pattern, via MIDI or by using the Trigger button on the device panel). This lets you use the Redrum as a "trig sequencer", controlling other devices. The length of the gate signal depends on the Decay/Gate setting for the sound: In Decay mode, a short "trig pulse" is sent out, while in Gate mode, the gate signal will have the same length as the drum note.
Gate In	Allows you to trigger the sound from another CV/Gate device. All settings apply, just as when playing the drum sound conventionally.
Pitch CV In	Lets you control the pitch of the drum sound from another CV device.

## Other

Connection	Description
Send Out 1-2	Outputs for the send signals controlled with the S1 and S2 knobs.
Stereo Out	This is the master stereo output, outputting a mix of all drum sounds (except those for which you use individual outputs).



# **Chapter 36**

## **Kong Drum Designer**

# Introduction

The Kong Drum Designer gives the visual impression of a pattern-based drum machine, like the legendary MPC units. Indeed, it does have a matrix of 4 x 4 pads that are used for playing the sounds, just like the aforementioned classics. There are significant differences, however.

Kong features 16 drum “sound channels” that can host one drum sound each. Each drum sound can consist of a sound module routed through various types of FX and processing modules, allowing for completely open-ended sound design possibilities. Individual drum sounds can be saved as Drum Patches and complete drum kits can be saved as Kit Patches, allowing you to mix and match drum sounds and make up custom kits with ease.

In addition, Kong also has sampling capability. This means that you can sample your own sounds straight into any of the 16 drum channels with just a click of a button!

## Overview



*The Kong front panel.*

Kong is an advanced drum sound synthesizer, sampler/sample player and REX loop/slice player with many unique features. The design could be described as semi-modular, in that the sound, FX and audio processing modules are open slots that allows you to select between an array of different sound generators, FXs and audio processor types. As a result, Kong is capable of producing an astounding array of drum and percussion sounds - or any type of sound, for that matter. While it offers a lot of scope for serious sound design, it still has a straight-forward and user-friendly interface.

Kong also features audio inputs on the back panel. By connecting the output of another device to these inputs, you can use Kong's audio processing modules to process external sound. You can also route drum sounds for audio processing in external devices.

## The Pad Section

The pad section features 16 pads. Each of these pads can be assigned to a separate Drum sound. You can also choose to assign several pads to one and the same Drum sound - or to link pads so that one pad will trigger several other pads as well. To the right of the pads is the Pad Settings area where you can control the pad assignments and behavior. See [“Pad Settings”](#).



## The Drum Control Panel

The Drum Control Panel at the bottom left of the panel shows the name and “macro parameter” settings for the selected pad in the pad section. From the Drum Control Panel you can also load and save Drum Patches as well as initiate sampling. See [“The Drum Control Panel”](#).

## The Drum and FX Section

By clicking the Programmer button below at the bottom of the Drum Control Panel you can bring up the Drum and FX Section. Here is where you can edit your drum sounds and combine with various types of sound processors and FX. See [“The Drum and FX section”](#).

## About using custom backdrops

As with the Combinator device, it is possible to customize the Kong front panel graphics with a user-designed skin. In the [Reason Download](#) section at the Propellerhead website is the “Combi and Kong Backdrop Templates” zip file, which can be used as starting point for designing your own Kong panel graphics. See the “Read Me.txt” file in the Backdrops folder for more details. Note that you should use separate backdrops for folded vs. unfolded states.

## About file formats

Kong can read the following file types:

### Kit Patches

A Kong Kit Patch (Windows extension “.kong”) contains all settings for all 16 Drum sound channels, including file references to any used drum samples (but not the actual samples themselves). Switching patches is the same as selecting a new drum kit.

### Drum Patches

A Kong Drum Patch (Windows extension “.drum”) contains all settings for the selected Drum sound channel, including file references to any used drum samples (but not the actual samples themselves). Switching Drum Patches is the same as selecting a new drum sound.

### Drum Samples

The audio file format support differs depending on which computer OS you are using.

The NN-Nano Sampler module in Kong can read and play back sample files of the following formats:

- **In Windows 7:**  
.wav, .aif, .mp3, .aac, .m4a and .wma.
- **In Mac OSX 10.7:**  
.wav, .aiff, .3g2, .3gp, .mp1, .mp2, .mp3, .mpeg, .mpa, .snd, .au, .sd2, .ac3, .aac, .adts, .amr, .caf, .m4a, .m4r and .mp4.
- **SoundFonts (.sf2)**  
SoundFonts are an open standard for wavetable synthesized audio, developed by E-mu systems and Creative Technologies.
- **REX file slices (.rx2, .rex, .rcy)**  
REX files are music loops created in the ReCycle program or when editing audio clips inline in Reason (see [“Bounce Clip to REX Loop”](#)). The NN-Nano lets you load separate slices from REX files as individual samples.

- **Any sample rate and practically any bit depth.**

See “[NN-Nano Sampler](#)” for details.

## REX Files

The Nurse Rex Loop Player module in Kong can read and play back files of the following formats:

- **REX files (.rx2, .rex, .rcy)**

REX files are music loops created in the ReCycle program or when editing audio clips inline in Reason (see “[Bounce Clip to REX Loop](#)”).

See “[Nurse Rex Loop Player](#)” for details.

## Using patches

When you create a new Kong device it is loaded with a default kit. If you like you can use the default kit - or you can load another Kong Kit patch (or create one from scratch, by loading individual Drum patches). A Kong Kit patch contains settings for the 16 Drum channels, complete with parameter settings and file references to any samples used.

## Loading a Kit Patch

To load a patch, use one of the following methods:

- **Use the browser to locate and open the desired patch.**

To open the browser, select “Browse Kong Patches” from the Edit menu or device context menu, or click the folder button in the patch section on the device panel.



- **Once you have selected a patch, you can step between all the patches in the same folder by using the arrow buttons next to the patch name display.**
- **If you click and hold on the patch name display on the device panel, a pop-up menu will appear, listing all Kong Kit patches in all currently expanded folders in the Patch Browser.**  
This allows you to quickly select another patch without having to step through each one in turn.
- **Use the drag and drop method to drag Kong Kit Patch files from the Browser and drop on the Kong panel.**  
The Kong panel is dimmed in orange and a Patch Replace symbol appears in the center.

## Checking the sounds in a Kit Patch

There are three ways you can listen to the sounds in a patch without using the main sequencer:

→ **By clicking the Pad buttons on the front panel.**



! **Note that the vertical click position on the pad determines the Velocity value. If you click towards the bottom of a pad, the velocity is low and at the top of each pad the velocity value is high.**

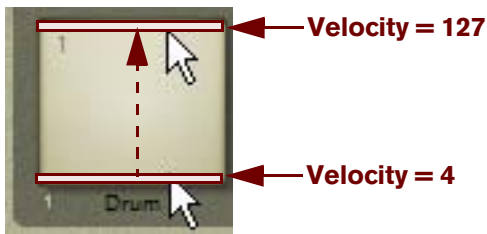

This will give you a good idea about the dynamics behavior of each drum sound. This also allows you to record in the main sequencer using the full dynamic range of each drum sound, even without a connected MIDI keyboard/control surface.

→ **By playing the keys C1 to D#2 or C3 to B6 on your MIDI keyboard or on the On-screen Piano Keyboard.**

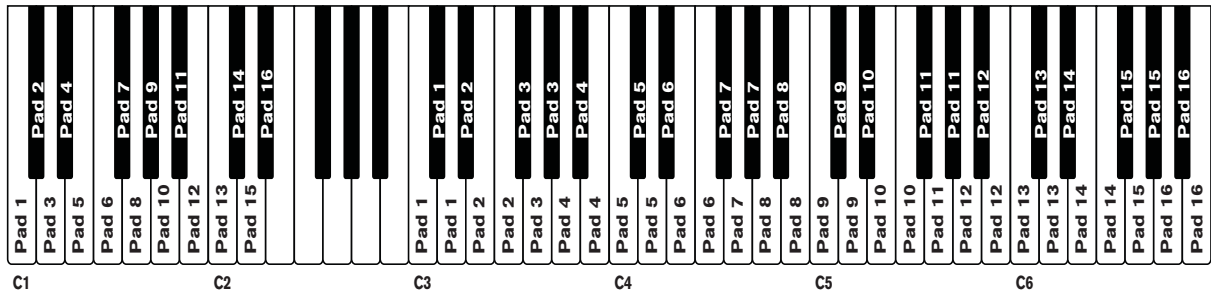

In the C1-D#2 range, each MIDI note will trig one pad each, from Pad 1 to Pad 16. In the C3-B6 MIDI note range each pad can be triggered from three adjacent keys on your MIDI keyboard. C3-D3 trigs Pad 1, D#3-F3 trigs Pad 2 and so on. The C3-B6 note range is perfect if you want to play fast passages by triggering the same pad from several keys on your MIDI keyboard.

## Creating a new Kit Patch

To create a patch of your own (or modify an existing patch), use the following basic steps:

**1. Click on the pad for the drum sound you want to load or replace.**

A blue frame surrounds the selected pad.



## 2. Click the folder button on the Drum Control Panel.



- **Alternatively, right-click (Win) or [Ctrl]-click (Mac) on the Pad and select “Browse Drum Patches...” from the context menu.**

The Patch Browser opens.

## 3. Locate and open a Kong Drum Patch (extension ‘.drum’) or a sample or REX file.

You will find a selection of Kong Drum Patches in the Factory Sound Bank (in the Kong Drum Patches folder).

Loading a sample will automatically open it in an NN-Nano Sampler module (see “[NN-Nano Sampler](#)”) and loading a REX file will automatically open it in a Nurse Rex Loop Player module (see “[Nurse Rex Loop Player](#)”).

You can also sample your own sound into a Drum, see “[Sampling in Kong](#)”.

- **Alternatively, drag a Kong Drum Patch file, a REX file, a sample or a REX slice from the Browser and drop on the Drum Control Panel - or on any desired drum pad.**

Depending on if you drop a Drum Patch file, a REX file or a sample/REX slice, the Drum Control Panel or pad is dimmed in orange or blue and a Patch/Sample Replace symbol appears in the center.

- ! **It is important that you drop REX files either on the Drum Control Panel or on a pad. Dropping it elsewhere will replace the entire Kong device with a Dr. Octo Rex device and load the REX file in this device instead!**

## 4. Change some parameter settings for the drum sound channel using the knobs on the Drum Control Panel.

These parameters are described in “[The Drum Control Panel](#)”. Note that the Drum Control Panel parameters are “global” for each Drum channel. Each drum sound can consist of a number of different sound and FX modules, each with their separate set of parameters. Refer to “[The Drum modules](#)”, “[The Support Generator modules](#)” and “[The FX modules](#)” for details about all the modules that can be used to build up a complete Drum sound.

## 5. Repeat steps 1 and 4 for the other drum sound channels.

## 6. When you’re satisfied with the drum kit, you can save the patch by clicking the Floppy Disk button in the patch section on the Drum panel.

Note however, that you don’t necessarily need to save the Drum patch - all settings are included when you save a Kong Kit Patch (see “[Saving Kit Patches](#)”) and/or your song.

# Creating an empty Kit Patch

To “initialize” the settings in the Kong, select “Reset Device” from the Edit menu or the device context menu. This removes all samples for all drum sound channels, and sets all parameters to their default values.

# Saving Kit Patches

Saving patches is done in the same way as with any other Reason device - see “[Loading patches](#)” and “[Saving patches](#)”.

- ! **Note that you don't have to save any of the 16 individual Drum patches first if you don't want to - all settings for each individual Drum patch are included in the Kong Kit patch.**

# Pad Settings

In the Pad Settings section to the right of the Pad section you can perform various assignments and tricks pertaining to how the Drum channels should be controlled from the Pads.

## Assigning Drums to Pads

Kong features 16 pads and 16 Drum channels, as described earlier. Each pad can control a separate Drum sound channel. You can also assign several pads to control a single Drum sound channel. This is especially useful if you want to apply different settings, like Hit Types (see “Assigning Hit Type to Pads”), for each pad so that the controlled Drum sound channel responds differently. By default the 16 pads are assigned to their corresponding Drum sound channel; Pad 1 to Drum 1 and so on. If you want to change this assignment, proceed as follows:

1. **Select the desired Drum sound channel by clicking on its corresponding pad - or on the Pad name below the pad if you don't want the pad to trigger the sound.**

A blue frame surrounds the selected pad and the corresponding Drum is displayed in the Drum section to the left.

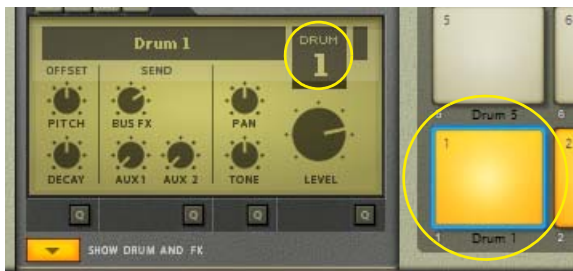

2. **Select the other pad you want to control Drum 1 from.**

In this example, we select Pad 2.



3. **Click on button 1 in the Drum Assignment section to assign Pad 2 to Drum 1.**



Now, Pad 2 is also assigned to play Drum 1. Below Pad 2 it now says “Drum 1” to indicate the current assignment.

## Assigning Drums to Pads using the Quick Edit function

If you want to assign several Drums to several pads quickly, you can do this by using the Quick Edit function.

1. Click the Quick Edit button in the Drum Assign section.

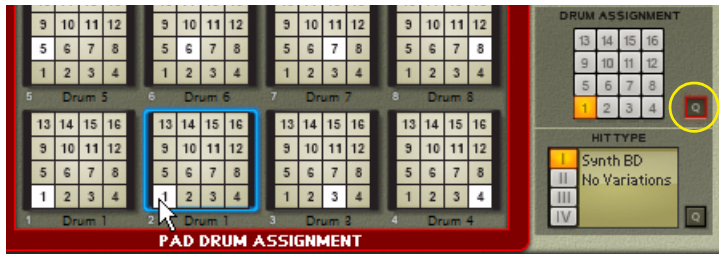

Each Pad now shows the current Drum assignment.

2. Change the Drum assignment clicking on the desired Drum channel number on each Pad.
3. When you are done, click the Quick Edit button or press [Esc] to exit to normal mode.

## Renaming Pads

→ Double click on the Pad name below the corresponding Pad, enter a new name and press [Enter].

## Copying & Pasting Drums between Pads

It's possible to copy a Pad with an assigned Drum and paste into another Pad location:

1. Select the source Pad.
2. Press [Ctrl](Win)/[Cmd](Mac)+[C].  
Alternatively, select "Copy Drum Patch" from the Edit menu or context menu.
3. Select the destination Pad.
4. Press [Ctrl](Win)/[Cmd](Mac)+[V].  
Alternatively, select "Paste Drum Patch" from the Edit menu or context menu.

Now, the complete Drum patch has been duplicated to the destination Pad and you can begin editing it as a separate patch.

## Assigning Hit Type to Pads

If you have assigned several pads to the same Drum sound channel, you can choose a different Hit Type for each of the pads (where applicable). Depending on Drum sound type, some of the sounds can have up to four pre-defined Hit Types. These Hit Types are shown in the Hit Type display.



For example, a Synth Hi-Hat Drum sound has four Hit Types by default: "Closed", "Semi-Closed", "Semi-Open" and "Open". By selecting a different Hit Type for each of the pads assigned to the same Drum, you can create a very nice and "live" sound.

- **To assign a Hit Type to a pad, select the pad and then select Hit Type by clicking the Hit Type button (or on the name in the display).**

The Hit Type assignment is saved when you save your Kong Kit Patch and/or song.

## Assigning Hit Type to Pads using the Quick Edit function

A quicker way of assigning Hit Type to several pads is by using the Quick Edit function.

1. **Click the Quick Edit button in the Hit Type section.**

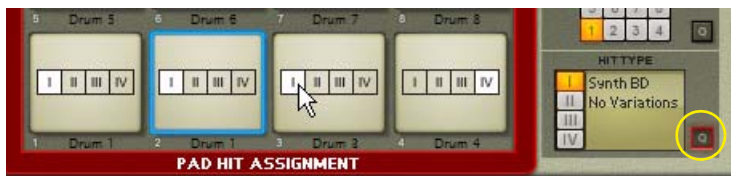

Each Pad now shows the current Hit Type assignment.

2. **Change the Hit Type assignment clicking on the desired Hit Type number on each Pad.**
3. **When you are done, click the Quick Edit button or press [Esc] to exit.**

## Muting and Soloing Pads

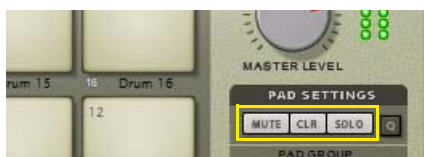

- **Click the Mute button to mute the assigned Drum for the selected Pad.**  
This will also mute MIDI control of the assigned Drum. Muted pads are displayed in red color.
- **Click the Solo button to solo the assigned Drum for the selected Pad.**  
Soloed pads are displayed in green color. All other pads are automatically muted. This also affects MIDI control of the Drum channels.
- **Click the CLR button to remove all Mute and Solo assignments.**

## Muting and Soloing Pads using the Quick Edit function

A quicker way muting and soloing several pads is by using the Quick Edit function.

1. **Click the Quick Edit button at the top of the Pad Settings section.**



Each Pad will now show a Mute and Solo button.

2. **Click the Mute and/or Solo buttons on the desired Pads.**
3. **When you are done, click the Quick Edit button to exit.**

# Working with Pad Groups

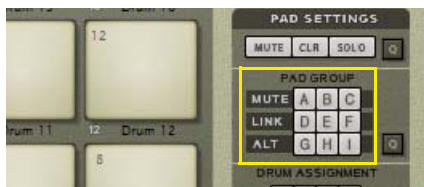

Kong features 9 Pad Groups, divided into 3 Mute Groups, 3 Link Groups and 3 Alt Groups. Each Pad can be assigned to one or more of these 9 Pad Groups independently. Pad Groups are useful if you, for example, want to trig several pads from a single pad, have one pad mute another, or randomly trig other pads from one pad.

## Mute Groups

Mute Groups can be used if you want one pad to automatically mute another sound in the same Mute Group. For example, if you assign an open hi-hat and a closed hi-hat sound to the same Mute Group, playing on one pad will automatically mute the sound assigned to the other pad.

## Link Groups

Pads assigned to the same Link Group will play together when you trig any of the pads in that group.

## Alt Groups

If you play pads assigned to the same Alt Group, the pads will be triggered in a random fashion, one by one. It doesn't matter which pad you play in the group, the pad triggering is always random.

## Assigning Pads to Pads Groups using the Quick Edit function

A quicker way of assigning several pads to Pad Groups is by using the Quick Edit function.

1. Click the Quick Edit button in the Pad Group section.



Each Pad now shows the current Pad Group assignment.

2. Edit the Pad Group assignment by clicking on the desired Pad Group letter on each Pad.



In the picture above, Pads 9 and 10 are assigned to Alt Group "G", which means they will trigger alternating when you play any of these Pads.

Pads 11 and 12 are assigned to Mute Group "B", which means that playing Pad 11 will mute Pad 12 and vice versa.

3. When you are done, click the Quick Edit button or press [Esc] to exit.



# The Drum and FX section



The Drum and FX section in Kong is built up of the Drum Control Panel and the Drum and FX section.

→ **Click the Show Drum and FX button below the Drum Control Panel to unfold the Drum and FX section.**

The Drum and FX section consists of five slots:

- **The Drum Module Slot.**
- **The FX1 Slot.**
- **The FX2 Slot.**
- **The Bus FX Slot.**
- **The Master FX Slot.**

The Drum, FX1 and FX2 slots are unique to each of the 16 Drum channels in Kong. The Bus FX and Master FX slots are shared between all Drum channels in the Kong device. You can activate/deactivate any of the slots by clicking the On button at the upper left of each slot.

## Signal flow

The output signal from a Drum module is sent via the FX1 and FX2 Slots to the Bus FX, Master FX or to a pair of the individual outputs on the back of the Kong panel. There is also an internal Bus FX Send that can be used to send an audio signal from the Drum via the FX1 and FX2 Slots to the Bus FX. The Bus FX Slot can hold e.g. a reverb module which can be used as a send effect for all the Drum channels. As an extra bonus, you can also hook up an external effect device between the Bus FX and Master FX Slots, see [“Using external effects with Kong”](#).

The signal routing in the Drum and FX section depends on the Drum Output selector setting at the bottom of the Drum and FX section:



The different signal flows are described in the following paragraphs:

### Master FX Drum Output

When the Drum Output is set to “Master FX”, the signal flow is according to the picture below. If you are using a Bus FX, this is treated as a Send effect with the Bus FX level controlled by the Bus FX knob on the Drum Control Panel.

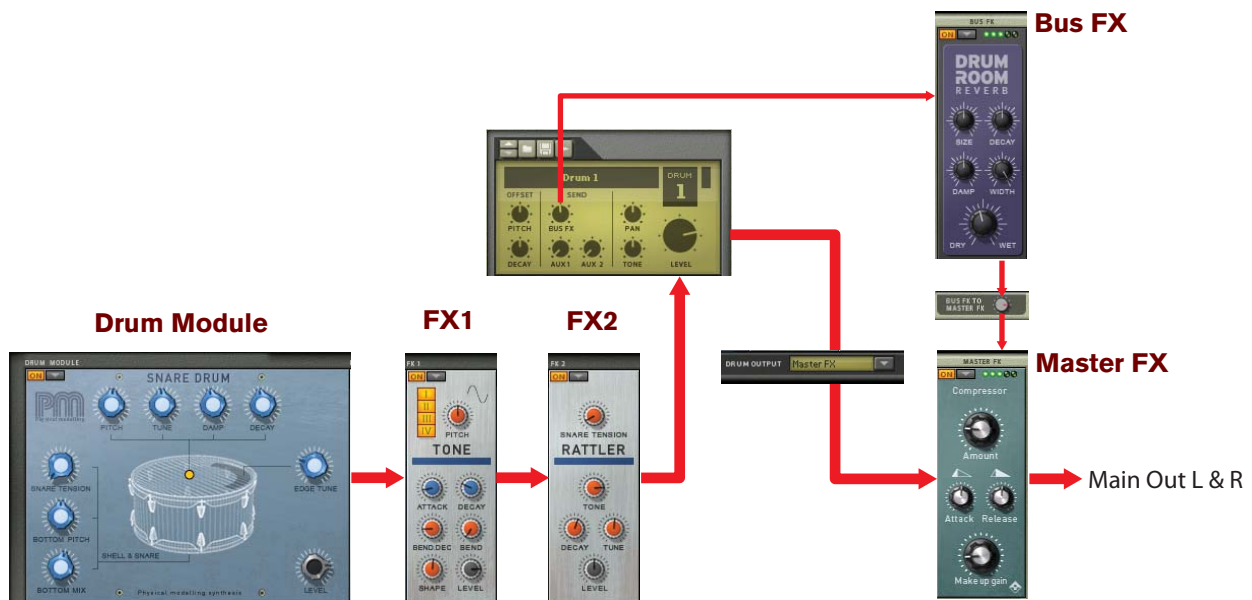

Signal flow when Drum Output is set to “Master FX”.

## Bus FX Drum Output

When the Drum Output is set to “Bus FX”, the signal flow is according to the picture below. Note that the Bus FX is now routed both as an Insert effect and as a Send effect at the same time. Therefore, it might be a good idea to set the Bus FX Send knob on the Drum Control Panel to zero in this configuration.

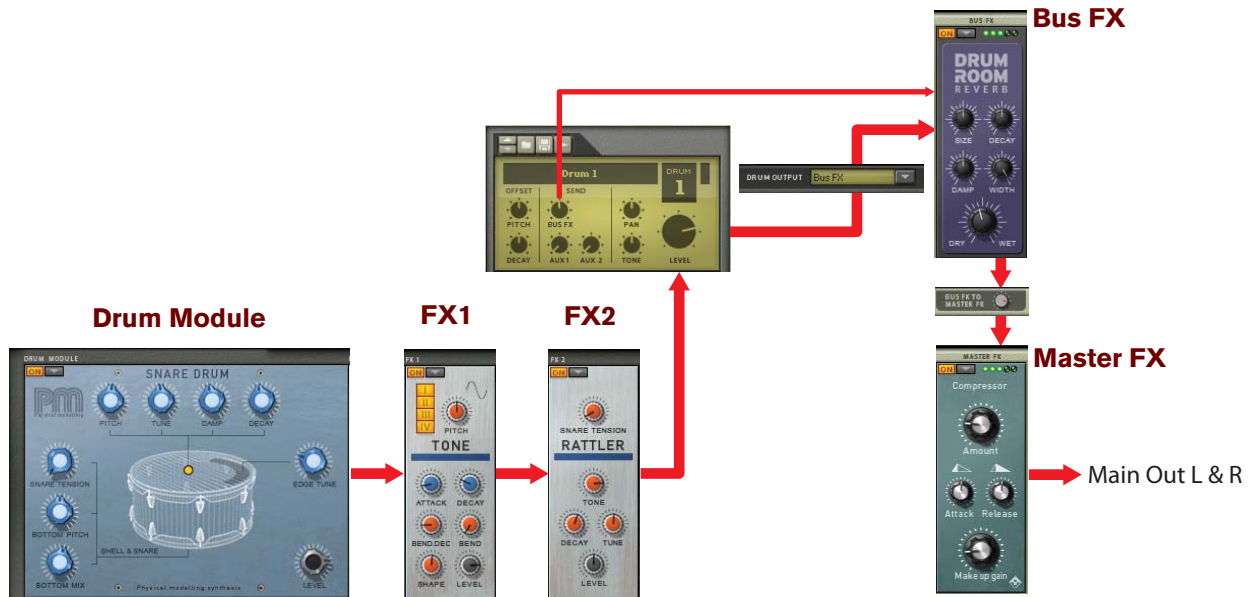

Signal flow when Drum Output is set to “Bus FX”.

## Separate Out Drum Output

When the Drum Output is set to any of the separate output pairs “3-4” to “15-16”, the signal flow is according to the picture below. The signals to the selected separate output pair are taken directly after the FX2 via the Master Level knob. Note that the signal via the Bus FX and Master FX is still available on the Main Out L & R and can be controlled with the Bus FX Send knob on the Drum Control Panel.

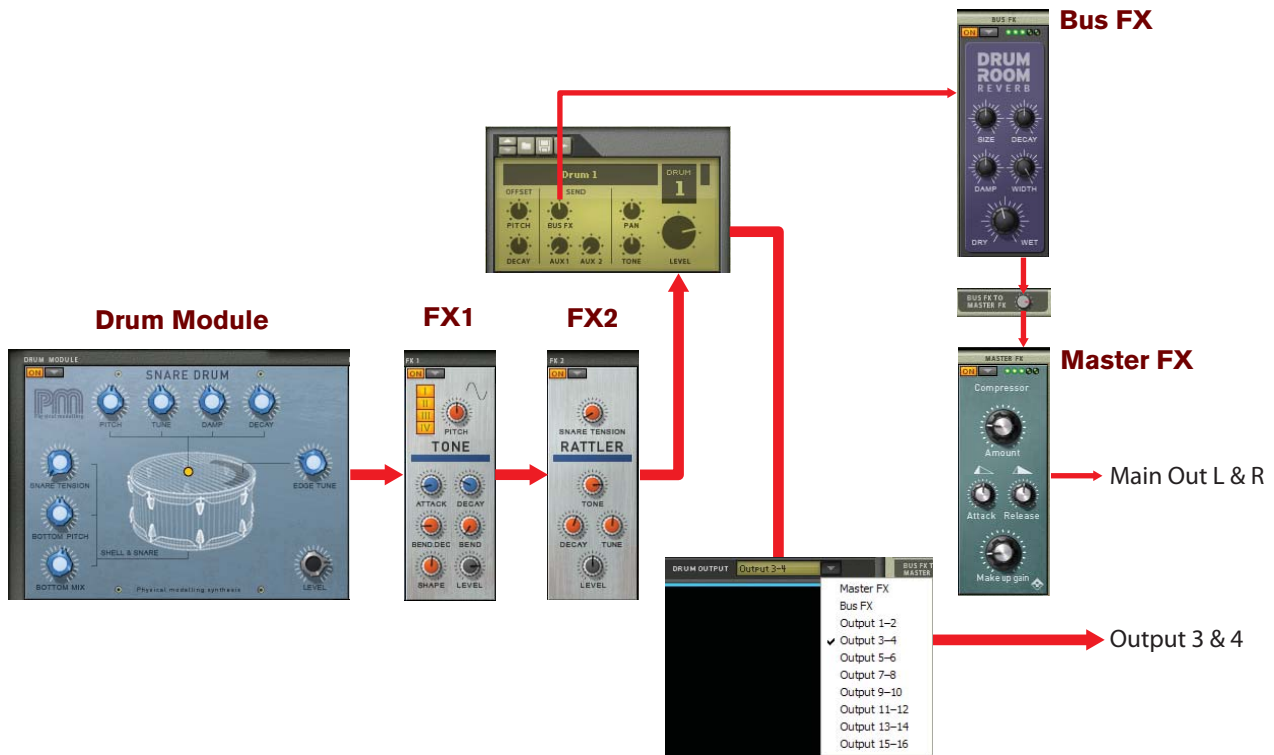

Signal flow when Drum Output is set to any of the separate output pairs “3-4” to “15-16”.

## The Drum Control Panel



The Drum Control Panel features a set of “macro controls” that affect parameters in each Drum. These controls scale the parameters in the Drum module and FX modules in the Drum and FX section. There are also some standard parameters that are identical for each Drum: Pan, Tone and Level.

- **The Pitch Offset knob affects the Pitch parameters in all Drum modules.**  
No FX modules are affected, even if they feature a Pitch parameter.

- **The Decay Offset knob affects the amplitude Decay or Release parameters in all Drum modules plus any FX modules that feature a Decay parameter.**  
For example, the reverb decay time in the Room Reverb FX module is affected by the Decay Offset parameter.
- **The Bus FX Send knob affects the signal level sent to the Bus FX Slot.**  
Depending on current Drum Output setting, the effect will be a little different - see the examples in "Signal flow".
- **The Aux 1 and Aux 2 Send knobs controls the level to any devices connected to the Aux 1 and Aux 2 Send Outputs on the back of the panel, see "Aux Send Out".**  
The signals to the Aux Send is tapped after the FX1 and FX2 Slots but before the Bus FX and Master FX Slots.
- **The Pan parameter controls the panning of the signal in the stereo panorama.**  
The Pan parameter affects the signal after the FX1 and FX2 Slots but before it is sent to the Bus FX and Master FX Slots.
- **The Tone parameter is a built-in filter (similar to the filter in Redrum).**  
The Tone parameter affects the signal after the FX1 and FX2 Slots but before it is sent to the Bus FX and Master FX Slots.

## Editing the Drum Control Panel parameters using the Quick Edit function

A quicker way of editing the Drum Control Panel parameters for several Drum channels at once is by using the Quick Edit function. The Drum Control Panel features four Quick Edit buttons.

1. **Click the Quick Edit button below the Pitch and Decay Offset section.**



Each Pad now shows the current Pitch and Decay Offset settings for each assigned Drum channel.

2. **Edit the Pitch and Decay Offsets by clicking and dragging the "crosshair" on the desired Pads.**

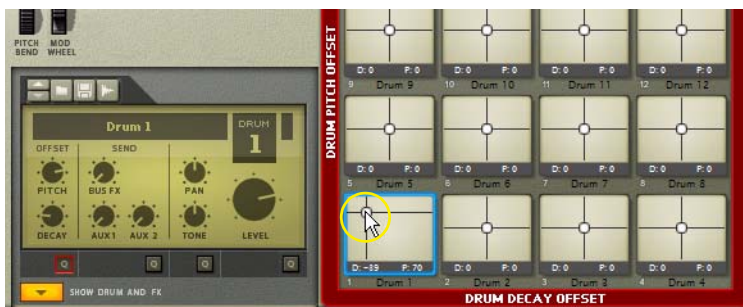

The Decay Offset is on the horizontal X-axis and the Pitch Offset is on the vertical Y-axis, as shown in plain text on the big red frame around the Pad section. As you move the crosshair, the corresponding knobs on the Drum Control Panel move as well - and vice versa.

3. **When you are done, click the Quick Edit button or press [Esc] to exit - or click another Quick Edit button to change other sets of parameters.**

## Loading and Saving Drum Patches



Loading and Saving Kong Drum patches (".drum") are done in the same way as with any other Reason device - see "Creating a new Kit Patch", "Loading patches" and "Saving patches".

A Kong Drum patch contains all parameter settings on the Drum Control Panel, including modules and parameter settings in the Drums and FX section - with references to any used samples.

It's also possible to load samples and REX loops in the Drum Control Panel section. Loading a sample will automatically open it in an NN-Nano Sampler module (see "NN-Nano Sampler") and loading a REX file will automatically open it in a Nurse Rex Loop Player module (see "Nurse Rex Loop Player").

## Sampling in Kong

The sampling procedure is the same for all devices that can sample (Kong, NN-19, NN-XT and Redrum). The sampling and sample editing procedures are described in detail in the "Sampling" chapter.

- **To sample your own sound and automatically load it into an NN-Nano Sampler module in the Drum and FX section, click the Sample button for the desired Drum channel.**



Refer to the "Sampling" chapter for details on how to set up and use the sampling feature.

## The Drum Module slot



Each Drum channel in Kong has a main module slot - the Drum Module slot - to which you can load one of 9 different types of drum sound modules for designing drum sounds.

- **Select Drum Module type by clicking the button to the right of the On button and selecting the module from the pop-up.**

the following Drum Module types can be selected: NN-Nano Sampler, Nurse Rex Loop Player, Physical Bass Drum, Physical Snare Drum, Physical Tom Tom, Synth Bass Drum, Synth Snare Drum, Synth Tom Tom and Synth Hi-Hat. See [“The Drum modules”](#) for details about each Drum module.

- ! **Note that only four pre-defined parameters per Drum Module can be automated!**

At the bottom below the Drum Slot is the Pitch Bend Range parameter which controls the Pitch Bend Range for the Drum Slot. This parameter is global for all types of Drum Modules but is unique to each of the 16 Drum channels.



*The Pitch Bend Range knob for each of the 16 Drum channels*

## The FX slots



Each Drum channel also has 2 insert effect slots - the FX 1 and FX 2 Slots - to which you can load one of two different types of support sound generators or one of 9 different effect modules.

- **Select Module type by clicking the button to the right of the On button and selecting module from the pop-up.** the following module types can be selected for the FX 1 and FX 2 Slots: Noise generator, Tone generator, Room Reverb, Transient Shaper, Compressor, Filter, Parametric EQ, Ring Modulator, Rattler, Tape Echo and Overdrive/Resonator. See [“The Support Generator modules”](#) and [“The FX modules”](#) for details about each module type.

- ! **Note that only two pre-defined parameters per FX/Support Generator Module can be automated!**
- **For the Bus FX and Master FX slots, all module types except the Noise and Tone generators can be selected.**

# The Drum modules

! Note that only four pre-defined parameters per Drum Module can be automated!

## NN-Nano Sampler



The NN-Nano Sampler is based on the NN-XT Sampler and was designed to be ideal for drums and percussion sounds.

The NN-Nano can handle samples or sets of samples for each of the four different Hit Types described in "Assigning Hit Type to Pads". Each Hit Type can contain one or several samples which can be layered and/or altered and controlled individually via velocity.

## Loading samples

1. Select the Hit you want to load the sample(s) into by clicking in the display.



2. Click the Browse Samples (folder) button and select one or several WAV, AIFF or SoundFont Samples or REX slice files.

3. Click the Load button in the Browser.

The sample(s) are loaded in the selected Hit.

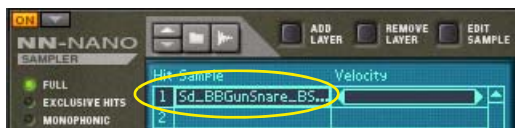

→ Alternatively, drag a sample, a REX slice or a SoundFont file from the Browser and drop on the NN-Nano panel.

The NN-Nano panel is dimmed in blue and a Sample Replace symbol appears in the center.

If you selected several samples in the Browser, these will be loaded as separate Layers in the selected Hit.

If you like you can load additional samples, either into another Hit or into a new Layer in the same Hit. To load a new sample in a new Layer in the same Hit, proceed as follows:



## 1. Select the Hit and then click the Add Layer button.

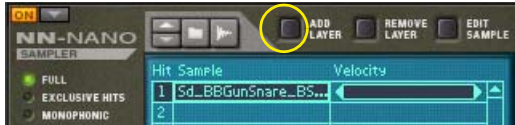

An additional space is created in the Hit.

## 2. Select the empty Layer in the display and load a new sample according to the description in “Loading samples” above.

The NN-Nano Sampler module in Kong can read and play back sample files of the following formats:

- **In Windows 7:**  
.wav, .aif, .mp3, .aac, .m4a and .wma.
- **In Mac OSX 10.7:**  
.wav, .aiff, .3g2, .3gp, .mp1, .mp2, .mp3, .mpeg, .mpa, .snd, .au, .sd2, .ac3, .aac, .adts, .amr, .caf, .m4a, .m4r and .mp4.
- **SoundFonts (.sf2)**  
SoundFonts are an open standard for wavetable synthesized audio, developed by E-mu systems and Creative Technologies.
- **REX file slices (.rx2, .rex, .rcy)**  
REX files are music loops created in the ReCycle program or when editing audio clips inline in Reason (see “Bounce Clip to REX Loop”). The NN-Nano lets load separate slices from REX files as individual samples.
- **Any sample rate and practically any bit depth.**

## Replacing samples

→ To replace one or several samples, select the sample(s) in the display and then load new samples according to the description in “Loading samples”.

This way it is possible to e.g. replace three selected samples with three new samples in one go.

## Adding and Removing Layers

→ To add a new Layer to a Hit, select the Hit and click the Add Layer button.

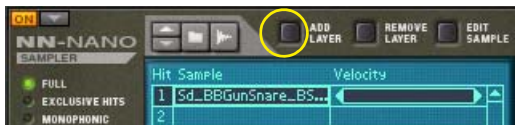

An additional space is created in the Hit for the created Layer.

→ To remove a Layer from a Hit, select the Layer and click the Remove Layer button.



The Layer is removed together with its sample (if any).

## Sampling into the NN-Nano

The sampling procedure is generic for all devices that can sample (Kong, NN-19, NN-XT and Redrum). The sampling and sample editing procedures are described in detail in the “Sampling” chapter.

→ To sample your own sound and automatically load it into the NN-Nano, click the **Sample** button.



Refer to the “[Sampling](#)” chapter for details on how to set up and use the sampling feature.

## The Edit Sample button



If you click the Edit Sample button with a sample selected in the display, the sample will open in the generic Edit Sample window. In this window you can edit the sample and save as a self-contained Song Sample. See “[The Edit Sample window](#)” in the Sampling chapter for details about editing samples.

## Sample parameters

There are a number of parameters that are unique to each individual sample and Hit in the NN-Nano. These parameters are visible in the display for the selected (highlighted) sample:



- **Velocity**  
The Velocity range can be set, either by clicking and dragging the Velocity bar sideways to the right of the sample, or by clicking and dragging the Vel Lo and Hi values vertically at the bottom of the display.
- **Level**  
Set the sample level by clicking and dragging the Level value up or down in the display.
- **Pitch**  
Set the sample pitch by clicking and dragging the Pitch value up or down in the display.
- **Alt**  
Click the Alt box for several samples in the same Hit to make them play back alternating.
- **Hit Name**  
Edit the Hit Name if you like by clicking in the Hit Name box, typing in a new name and then pressing [Enter]. The name will appear in the Hit Type display on the main panel (see “[Assigning Hit Type to Pads](#)”).

## Global parameters

The parameters located on the panel, outside the display, are global and affect all samples in all Hit groups equally.



- **Polyphony**

“Full” is, as the word implies, full polyphony. This means that all Hits can sound with full polyphony. Several Hits can also sound together if controlled from separate Pads that are assigned to different Hit Types.

“Exclusive Hits” means that when one Hit plays it will automatically mute any other sounding Hits. The polyphony is still full within each Hit, though.

“Monophonic” is... well, monophonic.

- **Mod Wheel**

If you want the Mod Wheel to affect the pitch and/or decay of the sound, you can set this with the Mod Wheel -> Pitch and/or the Mod Wheel -> Decay knobs. Both parameters are bipolar (+/-).

- **Velocity**

In the Velocity section you can control how the velocity should affect a number of parameters. The parameters are: Pitch, Decay, Level, Bend and Sample Start. All parameters are bipolar (+/-).

- **Pitch**

Here you can set the global Pitch, Pitch Bend Amount and Pitch Bend Time for all samples. The Pitch and Pitch Bend Amount parameters are bipolar (+/-).

- **Osc**

In the Osc section you can set the global Sample Start and Reverse parameters for all samples in the NN-Nano.

- **Amp Env**

The Amp Env section contains an Attack-Decay Envelope and the global Level parameter for all samples. There is also an envelope trig mode selector for choosing between Gate and Trig mode. In Gate mode (the square symbol), the Decay time defines the minimum gate time. If you hold down a key or pad on your MIDI keyboard/control surface, the Decay stage will set in after you released the key/pad.

# Nurse Rex Loop Player



The Nurse Rex Loop Player is based on the Dr. OctoRex Loop Player but has been modified to be ideal for playing and triggering drum and percussion sounds.

The Nurse Rex can load standard REX files and play back the loops and/or slices in a variety of ways depending on the selected Hit Type (see “Assigning Hit Type to Pads”).

## Loading REX files

1. Click the Browse Samples (folder) button.



2. Select a REX file and click the Load button in the Browser.

→ Alternatively, drag a REX file from the Browser and drop on the Nurse Rex panel.

The Nurse Rex panel is dimmed in orange and a Patch Replace symbol appears in the center.

The REX file is loaded in Nurse Rex with the loop shown in the display.

## Hit Types (playback modes)

Depending on selected Hit Type, the REX loop will play back differently. The editing possibilities also differs depending on selected Hit Type for the assigned pad.

- **Loop Trig**

In Loop Trig mode, you trig the REX loop to play one single cycle every time you hit the assigned pad. Loop Trig can also be used together with the “Stop” mode on another pad to immediately stop the loop playback, see “Stop” below.



← Loop range (Start and End)



*A REX loop with “Loop Trig” as Hit Type.*

- **Set Start and End slice, either by clicking and dragging the S and E numerical values up/down in the boxes, or by clicking and dragging the handles sideways in the “ruler” above the REX loop in the display.**



*Different ways of editing the Start and End Slice values.*

- **Chunk Trig**

In Chunk Trig mode, you can assign several pads to play back shorter sections - chunks - of the REX loop. The number of chunks is determined by the number of pads you have assigned to the REX loop using the Chunk Trig Hit Type. The chunks are distributed in equal sections across the REX loop. Chunk Trig can also be used together with the “Stop” mode on another pad to immediately stop the chunk playback, see “Stop” below.

In the picture below, we have assigned four pads to the same REX loop and we have selected “Chunk Trig” as Hit Type on all four pads:



*Four pads assigned to the same REX loop and Hit Type set to “Chunk Trig”.*

- **Set the size of the chunks by clicking and dragging the right edges of the “tabs” above the REX loop in the display.**

Doing so will automatically move the start position of the subsequent chunk so that the chunks will always be adjacent to each other.



*Editing the sizes of the chunks.*

- **Change the Start position of the first chunk and the End position of the last chunk by changing the REX loop Start and End values.**

In effect, this is the same as setting the overall REX loop start and end position.



*Editing the start position of the first chunk and end position of the last chunk.*

- **Slice Trig**

In Slice Trig mode, you can assign a pad to play back one single slice of the REX loop - or several slices alternately. By default, Slice 1 of any REX loop loaded into the Nurse Rex is set to play back when you have selected "Slice Trig" as Hit Type.



**Slice 1 plays back by default in Slice Trig mode**



*A REX loop with "Slice Trig" as Hit Type.*

- **Change the slice to play back by first removing the tick in the Trig checkbox and then clicking on another slice in the display and ticking the Trig checkbox for that slice.**

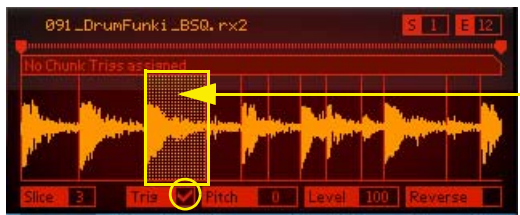

**Slice 3 plays back instead**

*Slice 3 selected for playback in Slice Trig mode.*

Another way of assigning a slice for playback, or to assign several slices to play back alternating, is by using the mouse in combination with the [Ctrl](Win)/[Cmd](Mac) key.

- **Hold down [Ctrl](Win)/[Cmd](Mac) and click on the slice(s) in the display you want to assign or deassign.**



**Slices 3, 5, 8 and 11 selected and will now play back alternating in Slice Trig mode**

*Slices 3, 5, 8 and 11 selected for playback in Slice Trig mode, forcing them to play back alternating.*

Selected slices are displayed with a red background. The currently "focused" slice is displayed with an orange background. Selected slices also get their corresponding Trig checkbox ticked automatically.

- **Stop**

The fourth Hit Type is named “Stop”. The Stop mode can be used if you want to use a pad for immediately stopping the currently playing REX loop or Chunk. The Stop mode should be used in combination with any of the Hit Types “Loop Trig” or “Chunk Trig”, otherwise it won’t be useful.



*“Stop” selected as Hit Type for a pad assigned to a Nurse Rex module.*

1. **Assign one pad to a REX loop in Nurse Rex and select any of the Hit Types “Loop Trig” or “Chunk Trig”.**
2. **Assign another pad to the same Nurse Rex module and select “Stop” as Hit Type.**

Now, when you play the first pad, the loop or chunk will play. Once you hit the second pad, the loop/chunk playback will immediately stop.

## Combining Hit Types

By combining the different Hit Types for the Nurse Rex module you can create really interesting setups. For example, you could load a REX loop and assign a couple of pads to the “Chunk Trig” Hit Type, one pad to Loop Trig, another one to Slice Trig and another pad to Stop. Playing the different pads can now generate really inspiring results. The picture below shows an example of this type of setup:



*Eight pads assigned to the same Nurse Rex module, with the pads set to different Hit Types (in Quick Edit mode).*

If we click the Hit Type Quick Edit button, we can see that Pad 1 is set to Loop Trig, Pads 2-6 are set to Chunk Trig, Pad 7 is set to Slice Trig and has four slices set to Trig in the REX loop display for alternate playback. Finally Pad 8 is set to Stop so we could stop the loop and chunks playback whenever we like.

## Editing Slice Parameters

In the REX loop display you can edit parameters that are unique to each separate slice:

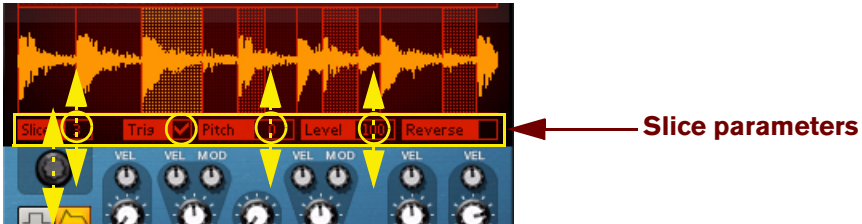

*Slices parameters for a loaded REX loop.*

→ **To select a slice for editing, click on the desired slice in the REX loop display.**

Alternatively, click and drag up/down in the Slice number box or use the Slice Select knob below the Slice item.

The Slice Parameters are:

- **Trig**  
Click the Trig check box for the slices you want to alternate between using the Slice Trig Hit Type.
- **Pitch**  
Set the pitch for each individual slice in the REX loop by clicking and dragging the Pitch value up/down.
- **Level**  
Set the level for each individual slice in the REX loop by clicking and dragging the Level value up/down.
- **Reverse**  
Click the Reverse box for the slices you want to play back backwards.

## The Nurse Rex panel parameters

On the Nurse Rex panel you can edit parameters that are common to all slices in the loaded REX loop:



- **Env Type**  
Sets the amplitude envelope type to "Gate" or "ADSR" (Attack, Decay, Sustain, Release). In Gate mode, the gate time is set with the Decay parameter.
- **Attack with Velocity control**  
Sets the attack time for the amplitude envelope when ADSR is selected as Env Type. The attack time can also be velocity controlled according to the sensitivity set with the Vel knob.
- **Decay with Velocity and Modulation controls**  
Sets the decay time for the amplitude envelope when ADSR is selected as Env Type. When Gate is selected as Env Type, the Decay parameter sets the gate time. The decay/gate time can also be velocity controlled according to the sensitivity set with the Vel knob. You can also control the decay/gate time from the Mod Wheel with the amount set with the Mod knob.
- **Sustain**  
Sets the sustain level of the amplitude envelope when ADSR is selected as Env Type. In Gate mode, the Sustain parameter has no effect.



- **Release with Velocity and Modulation controls**

Sets the release time for the amplitude envelope when ADSR is selected as Env Type. The release time can also be velocity controlled according to the sensitivity set with the Vel knob. You can also control the release time from the Mod Wheel with the amount set with the Mod knob. In Gate mode, the Release parameter has no effect.

- **Pitch with Velocity control**

Sets the overall pitch of all slices in the REX loop. The pitch can be velocity controlled according to the Vel knob setting. A negative Vel setting will lower the pitch with increasing velocity and a positive setting will raise the pitch with increasing velocity.

- **Level with Velocity control**

Sets the overall level of all slices in the REX loop. The level can be velocity controlled according to the Vel knob setting. A negative Vel setting will lower the level with increasing velocity and a positive setting will raise the level with increasing velocity.

At the top of the Nurse Rex panel is a button for setting the polyphony:



- **Polyphonic means full polyphony**

Retriggering the same slice/chunk will keep on adding more voices without muting any sustaining sounds.

- **Monophonic will make any new triggered loop/slice/chunk mute any currently playing/sustaining sound.**

## Physical Bass Drum, Snare Drum and Tom Tom



The Physical Bass Drum, Snare Drum and Tom Tom use very faithful mathematical models for generating acoustic drum sounds. The sounds of the PM drums are generated using physical modelling; mathematical real-time calculations of physical acoustic phenomena. The physical modelling technique allows for a lot more creative freedom, and much wider sonic ranges, compared to sample playback.

### General parameters

- **Level**

This controls the overall output level of the Drum module to the FX1 and FX2 Slots (see "Signal flow"). The Level is also affected by velocity.

## Drum head and shell parameters

The Physical Modelling Drums feature the following drum head and shell parameters:

- **Pitch**  
Sets the overall pitch of the drum. The Pitch parameter can be considered the total size of the drum and affects all other head and shell parameters.
- **Tune 1 and Tune 2 (PM Bass Drum and PM Tom Tom)**  
The Tune 1 and Tune 2 parameters set the drum's harmonic character, similar to the effect of individually adjusting the rim tension screws of the top drum head.
- **Tune (PM Snare Drum)**  
This controls the top drum head tension and thus affects the harmonic character of the sound.
- **Bend Amount (PM Bass Drum and PM Tom Tom)**  
This sets the dynamic "pitch bend" effect you get when hitting a drum head.
- **Damp**  
This controls the damping of the drum head.
- **Decay**  
The Decay parameter doesn't have any actual counterpart in real life. It simply controls the decay time of the drum sound.
- **Shell Level (PM Bass Drum and PM Tom Tom)**  
This controls how much of the drum shell sound should be present in the sound.
- **Shell Size (PM Tom Tom)**  
This controls the depth ("length") of the shell.
- **Edge Tune (PM Snare Drum)**  
This controls the head tuning when Hit Type 4 (Edge Hit) is selected for the pad (see ["Assigning Hit Type to Pads"](#)).
- **Snare Tension (PM Snare Drum)**  
This controls the tension of the snare and the distance between the snare and bottom drum head.
- **Bottom Pitch (PM Snare Drum)**  
This controls the pitch of the bottom drum head.
- **Bottom Mix (PM Snare Drum)**  
This controls how much of the bottom head sound should be present in the drum sound.

## Beater and Stick parameters

- **Density (PM Bass Drum)**  
This controls the "hardness" of the bass drum pedal beater.
- **Tone (PM Bass Drum and PM Tom Tom)**  
This is a filter which controls the tone of the hit.
- **Beater Level (PM Bass Drum)**  
This controls how much of the beater hit sound should be present in the drum sound.
- **Stick Level (PM Tom Tom)**  
This controls how much of the drum stick hit sound should be present in the drum sound.

# Synth Bass Drum, Snare Drum and Tom Tom



The Synth Bass Drum, Snare Drum and Tom Tom use analog modelling to generate classic synth drum sounds. The Synth Tom Tom was faithfully modelled after a famous hexagonal shaped analog drum system from the 80's.

## General parameters

- **Level**  
This controls the overall output level of the Drum module to the FX1 and FX2 Slots (see “Signal flow”). The Level is also affected by velocity.

## Drum parameters

The Synth Drums feature the following parameters:

- **Pitch**  
This sets the overall pitch of the drum. The Noise pitch is not affected by this parameter.
- **Tone (Synth Bass Drum)**  
This is a filter similar to the one used in Redrum and affects the tone of the drum. The Noise is not affected by this parameter.
- **Attack (Synth Bass Drum)**  
Sets the attack time of the drum sound. This also affects the Noise.
- **Decay**  
Sets the Decay time of the drum sound. This also affects the Noise decay on the Synth Bass Drum and is added to the Noise Decay parameter on the Synth Snare and Synth Tom Tom drums. It is also added to the Harmonic Decay value on the Synth Snare Drum. The Decay time is also affected by velocity.
- **Harmonic Balance (Synth Snare Drum)**  
Sets the level balance between the fundamental tone and the harmonic tone.
- **Harmonic Frequency (Synth Snare Drum)**  
Sets the frequency of the harmonic tone.
- **Harmonic Decay (Synth Snare Drum)**  
Sets the decay time of the harmonic tone. This is also affected by the Decay parameter.
- **Click Frequency (Synth Bass Drum)**  
Sets the frequency of the click sound in the attack.
- **Click Resonance (Synth Bass Drum)**  
Sets the resonance amount of the click sound in the attack.
- **Click Level (Synth Bass Drum and Synth Tom Tom)**  
Sets the level of the click sound in the attack.

- **Bend Time (Synth Bass Drum and Synth Tom Tom)**  
Sets the time it should take to change the pitch from the Bend Amount value (see below) back to the original pitch.
- **Bend Amount (Synth Bass Drum and Synth Tom Tom)**  
Sets the upper pitch to bend from. The Bend Amount is also affected by velocity.
- **Noise Tone (Synth Snare Drum and Synth Tom Tom)**  
This is a filter which sets the frequency content of the noise.
- **Noise Decay (Synth Snare Drum and Synth Tom Tom)**  
This sets the decay of the noise in the sound. The Noise Decay is also affected by the regular Decay parameter.
- **Noise Mix (Synth Snare Drum and Synth Tom Tom)**  
Sets the noise level in the drum sound.

## Synth Hi-hat



The Synth Hi-hat uses analog modelling to generate sounds. The Synth Hi-hat can be used for generating the typical hi-hat sounds of the early analog drum machines.

### Parameters

- **Pitch**  
This sets the overall pitch of the hi-hat sound.
- **Decay**  
This sets the decay time of the hi-hat sound.
- **Level**  
This controls the overall output level of the Synth Hi-hat module to the FX1 and FX2 Slots (see “Signal flow”). The Level is also affected by velocity.
- **Click**  
This controls the click level in the attack of the hi-hat sound.
- **Tone**  
This is a filter similar to the one used in Redrum and affects the frequency content of the hi-hat sound.
- **Ring**  
Sets the level of the resonance peaks in the sound. The higher the value, the more “metallic” the sound.

# The Support Generator modules

There are two types of Support Generator modules in Kong, one for generating noise and another one for generating a tone. The Support Generator modules can be used as companions to any of the Drum modules, or stand-alone. The Support Generators can be loaded into the FX1 and/or FX2 slots.

! **Note that only two pre-defined parameters per Support Generator module can be automated!**

## Noise Generator



- **Hit Type buttons**  
These buttons allow you to choose for which Hit Type(s) the Noise generator should be active. By default, the Noise generator is active for all Hit Types (see [“Assigning Hit Type to Pads”](#)).
- **Pitch**  
This sets the center pitch of the noise.
- **Attack**  
This sets the attack time of the noise.
- **Decay**  
This sets the decay time of the noise.
- **Reso**  
This sets the resonance amount of the noise around the center pitch.
- **Sweep**  
This sets the upper start pitch of the sweep range. The Sweep range is also affected by velocity.
- **Click**  
This sets the level of the click in the attack of the noise.
- **Level**  
This sets the overall level of the Noise generator. The level is also affected by velocity.

# Tone Generator



- **Hit Type buttons**  
These buttons allow you to choose for which Hit Type(s) the Tone generator should be active. By default, the Tone generator is active for all Hit Types (see [“Assigning Hit Type to Pads”](#)).
- **Pitch**  
This sets the pitch of the oscillator.
- **Attack**  
This sets the attack time of the tone.
- **Decay**  
This sets the decay time of the tone.
- **Bend Decay**  
This sets the decay time for the Bend.
- **Bend**  
This sets the upper start pitch of the bend range. The Bend range is also affected by velocity.
- **Shape**  
This sets the tonal character of the sound, from less to more harmonics.
- **Level**  
This sets the overall level of the Tone generator. The level is also affected by velocity.

# The FX modules

The FX modules can be used in any of the FX1, FX2, Bus FX and Master FX slots.

! **Note that only two pre-defined parameters per FX Module can be automated!**

## Using CV modulation of Bus FX and Master FX parameters

When the FX modules are used in the Bus FX and/or Master FX slots, it is possible to route external CV signals to the first two Effect module parameters for modulation. If you hover with the mouse over the first or second parameter of an FX module loaded in the Bus FX or Master FX slot, a tool tip appears:



The tool tip shows which CV modulation input on the back of the unfolded Kong panel will control that parameter. For FX modules loaded in the Bus FX slot, the tool tip displays “Bus FX P1: nn” for the first FX module parameter and “Bus FX P2: nn” for the second one. For FX modules loaded in the Master FX slot, the tool tip instead reads “Master FX P1: nn” for the first FX module parameter and “Master FX P2: nn” for the second one. The “nn” in the tool tip indicates the current parameter value.

By connecting cables to the CV modulation inputs on the back of the Kong panel, you can modulate the corresponding FX module parameters in the Bus FX and/or Master FX slots.

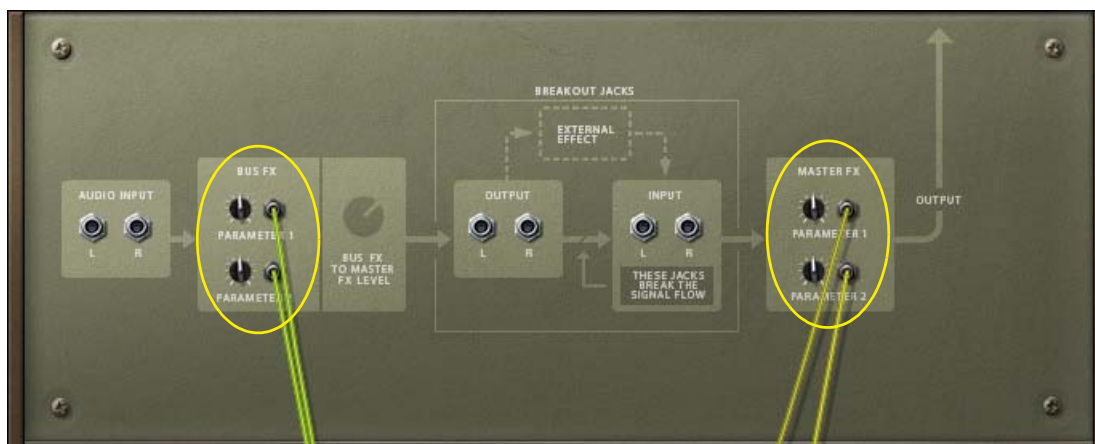

→ **Control the FX parameter modulation amounts with the corresponding attenuation knobs.**

If you decide to replace the FX modules in the Bus FX and/or Master FX slots, the modulation routing will be preserved - but the CV signals will now control the first two parameters of the replacement module(s).

## Drum Room Reverb



The Drum Room Reverb is a reverb with a room-type reverb algorithm. It's perfect for adding ambience to single drum sounds or to the entire mix of all 16 drum channels. The parameters are as follows:

- **Size**  
This sets the “size” of the room, from small to large.
- **Decay**  
This sets the reverb decay time.
- **Damp**  
This sets the high frequency damping amount of the reverb effect, from none to heavy.
- **Width**  
This sets the stereo effect of the reverb, from mono to wide stereo.
- **Dry/Wet**  
This sets the mix between Dry (no effect) and Wet (reverb) signal.

## Transient Shaper



The Transient Shaper is a type of dynamics processor which produces a result that could be compared to that of a compressor. As opposed to a “normal” compressor, the Transient Shaper mainly affects the signal's attack, or transients in the signal, making the signal transients cut through in the mix. The parameters are as follows:

- **Attack**  
A positive Attack value will produce an amplified attack/transient whereas a negative value will reduce the attack/transient volume.



- **Decay**  
This sets the decay time from amplification/attenuation back to normal amplitude level.
- **Amount**  
This controls the amplification amount. A high Amount in combination with a positive Attack value will produce a very pronounced attack/transient in the sound.

## Compressor



The Compressor levels out the audio, by making loud sounds softer. To compensate for the volume loss, the Compressor has a make-up gain control for raising the overall level by a suitable amount. The result is that the audio levels become more even and the sounds can get more “power” and longer sustain. The parameters are as follows:

- **Amount**  
This sets the sensitivity of the compressor. A high amount will make the compressor more sensitive and react to weak input signals.
- **Attack**  
This sets how fast the compression should be applied to the incoming signal. A low value will make the compression set in immediately whereas a high value will let the attack/transients through before compression sets in.
- **Release**  
This sets how long it should take before the compressor lets the sound through unaffected again. Set this to short values for more intense, “pumping” compressor effects, or to longer values for a smoother change of the dynamics.
- **Make up gain**  
This sets the overall level compensation. A low value will produce a softer output signal whereas a high value will amplify the output signal.

## Filter



The Filter is a state variable filter with a switch for selecting Lowpass, Bandpass or Highpass state. It has controls for cutoff/center frequency and resonance amount and can also be controlled from a built-in MIDI controlled envelope generator for sweeping the frequency. When used in the Bus FX Slot, MIDI Note E2 (#52) trigs the envelope. When used in the Master FX Slot, MIDI Note F2 (#53) trigs the envelope. The parameters are as follows:

- **Frequency**  
Sets the cutoff frequency in the LP and HP states and center frequency in the BP state.
- **Resonance**  
This sets the amplification amount of the frequencies around the cutoff/center frequency.
- **LP/BP/HP**  
Sets the state of the filter to either Lowpass, Bandpass or Highpass.
- **MIDI Trig EG Amount**  
This sets the amount of the MIDI controlled filter envelope. The Amount value is bipolar (+/-). Set to a positive value, the envelope will sweep the filter frequency from a high value down to the set Frequency value. Set to a negative Amount, the envelope will sweep the filter frequency from a low value up to the set Frequency value. The Amount is also affected by velocity.
- **MIDI Trig EG Decay**  
This sets the MIDI controlled envelope decay time.

## Parametric EQ



The Parametric EQ is a single-band parametric equalizer with controls for center frequency, gain and bandwidth (Q-value). The parameters are as follows:

- **Frequency**  
Sets the center frequency of the equalizer.
- **Gain**  
Sets the amplification (positive Gain value) or attenuation (negative Gain value) around the center Frequency.
- **Q**  
Sets the bandwidth around the center Frequency, from wide to a narrow peak.

## Ring Modulator



The Ring Modulator takes the input signal and multiplies it with an internal sinewave signal. The result is often a synthetic metallic sound. The Ring Modulator also features a MIDI controlled envelope generator for sweeping the internal sinewave frequency. When used in the Bus FX Slot, MIDI Note E2 (#52) trigs the envelope. When used in the Master FX Slot, MIDI Note F2 (#53) trigs the envelope. The parameters are as follows:

- **Frequency**  
Sets the frequency of the internal sinewave oscillator. The higher the frequency, the higher the resulting output signal pitch.
- **Amount**  
Sets the level of the internal sinewave oscillator. The higher the level, the more the ring modulation effect.
- **MIDI Trig EG Amount**  
This sets the amount of the MIDI controlled envelope. The Amount value is bipolar (+/-). Set to a positive value, the envelope will sweep the internal sinewave oscillator frequency from a high value down to the set Frequency value. Set to a negative Amount, the envelope will sweep the oscillator frequency from a low value up to the set Frequency value. The Amount is not affected by velocity.
- **MIDI Trig EG Decay**  
This sets the MIDI controlled envelope decay time.

## Rattler



The Rattler adds the effect of a snare “attached” to whatever sound is fed through it. Using the Rattler in combination with other types of sounds than “usual” snare drum sounds can produce really interesting results! Ever played a snare bass drum, or a snare hi-hat, for example? The parameters are as follows:

- **Snare Tension**  
This sets the tension of the snare. Note that when the Snare Tension is increased, the effect will actually be less pronounced since the snare will have “less contact” with the sound source.
- **Tone**  
This is a filter similar to the one used in Redrum and affects the frequency content of the output signal.
- **Decay**  
This sets how long the snare will “ring”.
- **Tune**  
This sets the snare tuning, from low to high, and affects the frequency content of the signal.
- **Level**  
This sets the overall level of the Rattler. The level is also affected by velocity.

## Tape Echo



The Tape Echo is based on the principles of classic tape echo effects. The original tape echo effects were electro-mechanical devices that used an endless magnetic tape in combination with recording and playback heads inside the box. Depending on the speed of the tape, and on which playback heads were used, the echo repetition and echo patterns could be controlled. Later on, a lot of tape echo effects were replaced by digital delay effects. The Tape Echo in Kong simulates the classic tape echo effect and features the following parameters:

- **Time**  
This sets the time between the delays, from short to long.
- **Feedback**  
This sets the number of delay repetitions, from one to... many.
- **Wobble**  
This sets the tape speed wobbling effect. Since it emulates a magnetic tape, a wobbling speed also automatically produces a wobbling pitch of the signal.
- **Frequency**  
This sets the change in frequency of the delay repetitions. For every delay, the frequency content will shift according to the Frequency setting. A low value will make each repetition sound muddier than the previous one, whereas a high value will make each delay sound brighter.
- **Resonance**  
This sets the resonance amount of the delay repetitions. Depending on the Frequency parameter setting above, different frequencies will be amplified.
- **Dry/Wet**  
This is a traditional dry/wet parameter for controlling the relationship between unprocessed and processed signal.

## Overdrive/Resonator



The Overdrive/Resonator is a combined distortion and resonator module. It can be used to add a nice distortion to the input signal. There is also a resonator section with a number of selectable characteristics, similar to the Body section in the Scream 4 Sound Destruction Unit. The parameters are as follows:

- **Drive**  
Sets the overdrive distortion amount.
- **Resonance**  
Sets the resonance amount for the resonator.
- **Size**  
Sets the size of the virtual “resonance chamber”, from small to large.
- **Model**  
Click to select one of five different resonator “body” characteristics.

# Connections

On the back panel of Kong are a number of connectors. Many of these are CV/Gate related. Using CV/Gate is described in the chapter [“Routing Audio and CV”](#).



## Sequencer Control

The Sequencer Control CV and Gate inputs allow you to play Kong from another CV/Gate device (typically a Matrix or a Redrum). The signal to the CV input controls the note pitch, while the signal to the Gate input delivers note on/off along with velocity.

## Modulation Input

These control voltage (CV) inputs (with associated voltage trim pots), can modulate various Kong parameters from other devices. These inputs can control the following parameters:

- **Volume**  
This controls the Master Level in Kong.
- **Pitch**  
This controls the Pitch Bend wheel in Kong.
- **Mod**  
This controls the Mod Wheel in Kong.

## Aux Send Out

The two stereo Aux Send Outputs can be used for connecting external effect devices for external signal processing. The signal levels to these Aux Send Outputs are controlled from the Aux 1 and Aux 2 Send knobs on the Drum Control Panel, see [“The Drum Control Panel”](#).

## Gate In and Out

- **The Gate Inputs can receive a CV signal to trigger each of the 16 pads individually.**  
You are still able to control the pads from the panel and/or via MIDI even when the Gate Inputs are being used.
- **The Gate Outputs send out a CV Gate signal each time the corresponding pad is played.**  
The Gate signals can be used for triggering sounds in other devices.

## Audio Out 3-16

There are 14 separate audio output jacks on Kong's back panel - arranged as seven separate stereo pairs. These outputs are never auto-routed but can be manually connected and selected as individual outputs for any of the Drum channels by using the Drum Output selector in the Drum and FX section, see "Signal flow".

## Main Audio Out

These are the main audio outputs. When you create a new Kong device, the Main Audio Output pair is auto-routed to the first available mixer channel.

## Using Kong as an effect device

Besides using the wide array of internal sound possibilities in Kong, you can also use it as an external effect device. If you unfold the Drum and FX section and flip the rack around, a set of additional audio jacks are visible at the bottom of the back panel.



These audio jacks can be used for connecting external devices and processing their audio in Kong. As you can see, the signal flow for processing external audio is printed on the back panel. Even if you want to use Kong for processing external signals, you can still play and use its internal Drum channels just like before.

Proceed as follows to connect an external device for audio processing in Kong:

1. **Connect the outputs of your other device (a synth, for example) to the Audio Inputs to the left.**

If your device only has a mono output, connect it to the Left Audio Input on Kong.

## 2. Play a couple of notes on your other device.

The audio is now routed via Kong's Bus FX slot and further via the Master FX slot, to the Main Audio Outputs of Kong.

## 3. Select suitable FX devices for the Bus FX and Master FX slots in Kong according to the descriptions in “The FX modules” and tweak the parameters to your liking.

- By connecting CV signals to the Parameter inputs in the Bus FX and Master FX sections on the back of the panel, you can modulate the first two parameters on the selected FX modules, see “Using CV modulation of Bus FX and Master FX parameters”.

Attenuate the CV signal with the corresponding knobs next to the modulation jacks.

# Using external effects with Kong

It's also possible to hook up an external effect device in the signal chain to process the Kong audio, or to process any external audio routed via the Audio Inputs to the left on the unfolded back panel of Kong.

- **Connect the external effect device to the External Effect Outputs and Inputs.**

In the picture below, an RV7000 Reverb is connected to Kong's External Effect section allowing the RV7000 to process the signal between Kong's internal Bus FX and Master FX slots:

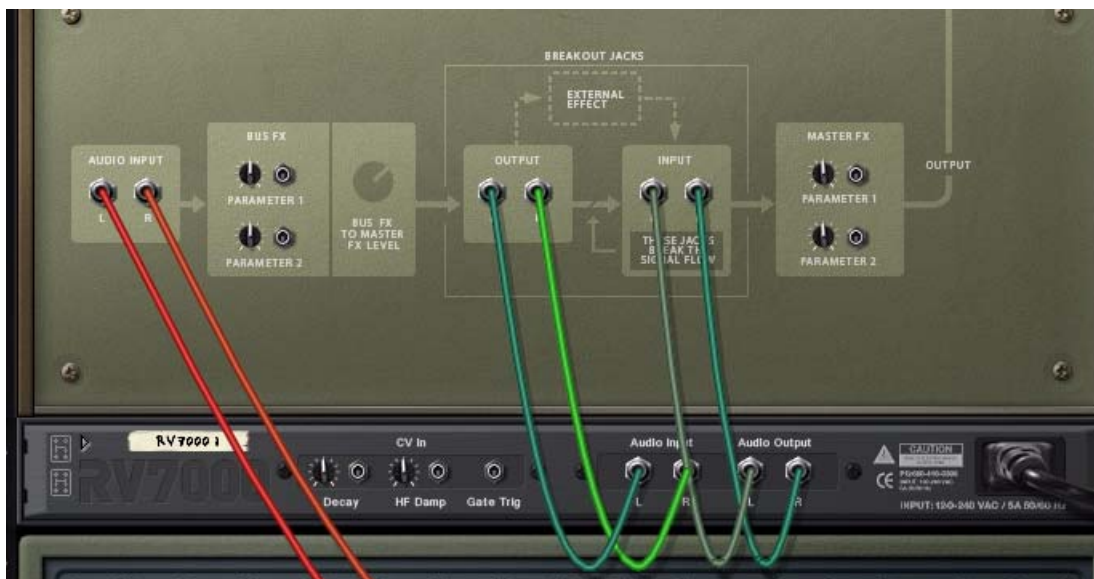

*An RV7000 Reverb connected to Kong for processing the Kong audio signals*

- ! **Note that if you have selected “Master FX” or “Separate Out” as output in the Drum Output selector, the BUS FX Send knob on the Drum Control Panel controls the signal level also to the External Effect, see “Signal flow”.**



# **Chapter 37**

## **External MIDI Instrument**

# Introduction



The External MIDI Instrument is a device designed for controlling external MIDI instruments, i.e. instruments that live outside of Reason. These could be other software synths or external hardware instruments that are hooked up to a MIDI interface on your computer.

The External MIDI Instrument is treated like any other instrument device in the Reason sequencer, including Note Lanes and automatable controls. One exception, though, is that the External MIDI Instrument device does not produce any sound of its own; it has to be routed via MIDI Out to an external MIDI instrument.

## Using the External MIDI Instrument

### Setting up for controlling an external MIDI instrument

! To be able to control external MIDI instruments from Reason it is required that you have installed a MIDI interface on your computer. Refer to the documentation of your specific MIDI interface for installation instructions.

1. Connect your external MIDI instrument to the MIDI interface on your computer: MIDI Interface MIDI Out to MIDI instrument's MIDI In.

If you want to play and/or record MIDI from your MIDI instrument to Reason, connect your instrument's MIDI Out to your computer's MIDI In as well, see ["Recording MIDI Controller automation from the controlled MIDI instrument"](#).

! If you are using the same MIDI instrument also as MIDI Master Keyboard for Reason, you will need to set it to "MIDI Local Off". Otherwise you will get doubled notes when you play your MIDI instrument.

→ To be able to hear your external MIDI instrument in Reason, connect your instrument's audio output(s) to the desired audio input(s) of your audio interface. Then, create an Audio Track, select the appropriate audio inputs and make sure the Monitor button on the Audio Track in the sequencer is on.



2. Create an External MIDI Instrument device from the "Instruments >" sub-menu in the Create menu or from the Instruments tab on the Device Palette in the Tool Window.

The device is created in the rack and a track is automatically created in the sequencer.

! Make sure that the MIDI instrument controlled by the External MIDI Instrument device does NOT transmit the MIDI data back to Reason (e.g. via "MIDI soft through" or "MIDI throughput"). This could cause MIDI feedback loops that could result in MIDI overflow in Reason.

Refer to the user manuals for your MIDI instruments for information on how to set the instruments to MIDI Local Off and how to prevent MIDI feedback loops.

3. Select the desired MIDI Port from the drop-down list to the right of the display.



All MIDI Ports that are currently available for Reason on your computer are displayed in the list.

4. Click the up/down MIDI Channel arrow buttons to select the MIDI Channel your external MIDI instrument is set to receive on.



The selected MIDI Channel number is shown in the display.

5. Select the External MIDI Instrument track in the sequencer.

Now, you should be able to play your external MIDI instrument from your Master Keyboard.

- ! If you get problems with “hanging” notes, press [!] to send out an “All Notes Off” command on the MIDI port.

The “MIDI: Send All Notes OFF” command can also be found in the Options menu.

## Controlling the sound of your external MIDI instrument



Besides the keyboard note control, you can also control the sound of your external MIDI instrument by using the Pitch (bend) and Mod (wheel) controls, as well as Keyboard Velocity and Aftertouch.

How your sound responds to these controls is totally dependent on how the sound was programmed in your external instrument. For example, Pitch Bend range, Mod Wheel modulation destination, Velocity and Aftertouch modulation need to be defined on your external MIDI instrument.

## Using MIDI Program Change

The Program Change MIDI message is used for selecting the desired sound/program/preset on MIDI instruments that have memory locations for stored sounds. The External MIDI Instrument device has a dedicated control for this, the Program control.

1. Click the On button to activate the MIDI Program Change function.



2. Click the up/down arrow buttons to select the Program number that corresponds to the sound you want to recall on your external MIDI instrument.



As soon as you load your Reason song, the External MIDI Instrument device will automatically send out the selected MIDI Program Change message on the set MIDI Port. This ensures that your connected instrument will play the correct sound/program/preset.

## Automating MIDI Program Change

If you like, you can automate the Program parameter to change sound/program/preset of your external instrument during playback of your Reason song.

**1. Right-click the Program up/down buttons, or the display, and select “Edit Automation”.**

This creates a separate Program Change automation lane in the sequencer track.

**2. Now, you can edit the Program Change lane in the sequencer and insert Program Change automation points wherever you like in your song.**

**! It’s recommended to place the Program Change automation points slightly before the positions where you want the new sound/program/preset to appear in your song. This is to allow for the time it takes to load the new sound in your external instrument.**

## A note about MIDI Bank Select

The MIDI Bank Select message is used for selecting specific banks of sounds/programs/presets in MIDI instruments that feature several sound banks.

There is no specific panel control for MIDI Bank Select in the External MIDI Instrument device. However, you can use the regular MIDI Controller automation described below for inserting Bank Select automation points. MIDI Bank Select normally uses MIDI CC #0 and/or #32. Refer to the MIDI documentation of your specific instrument for details.

**! Note that MIDI instruments that have several banks of sounds usually expect a Bank Select message to be immediately followed by a Program Change message in order to change the bank and program/preset. In these situations, sending only a Bank Select message - without a subsequent Program Change message - will not change anything.**

**! Note that Reason only sends out MIDI CC data when they actually change. This means that you might have to send a different “temporary” MIDI CC value just before you send the actual MIDI CC value. For example, if you want to resend the value “1” for MIDI CC#32, first send another value (e.g. “0” or “2”) and then send the value “1” immediately afterwards. You can do this by adding and/or moving automation points in the automation clip for MIDI CC#32 in the sequencer, see [“Editing parameter automation”](#).**

## Recording MIDI Controller automation

Besides automation of the panel controls, the External MIDI Instrument device allows you to record automation of MIDI Controllers 0-119. Each recorded MIDI CC# shows up on separate automation lanes in the sequencer and can be edited in the same fashion as regular “internal” parameter automation.

### Recording MIDI Controller automation from the External MIDI Instrument device

To record MIDI CC# automation from the External MIDI Instrument device, proceed as follows:

**1. Click the On button to activate the CC Assign function.**



**2. Select the desired MIDI CC# by clicking the up/down CC Assign arrow buttons.**



**3. Click Record in the sequencer and record the automation by turning the CC Assign knob.**



An automation lane, named according to the selected MIDI CC#, is created on the sequencer track and automation points are inserted as you turn the CC Assign knob. When you stop the sequencer, the CC Assign knob displays a green automation frame.

**4. To record automation of another MIDI CC# parameter, select the desired MIDI CC# by clicking the up/down CC Assign arrow buttons.**

The green automation frame around the CC Assign knob disappears as soon as you select a non-automated MIDI CC#. If you click back to the automated MIDI CC#, the automation frame appears again around the CC Assign knob.

**5. Repeat steps 2-3 for every new MIDI CC# you want to record.**

A new parameter automation lane is added on the sequencer track for every new MIDI CC# you record.

- You could also draw parameter automation points in parameter automation clips the same way as with internal Instrument devices in Reason, see **“Automation editing”**.

## Recording MIDI Controller automation from a Remote control surface

If you have a MIDI keyboard or control surface with knobs or sliders, you can use these to control parameters on your MIDI instrument and record automation. This is done using Remote Override Mapping:

**1. Click the On button to activate the CC Assign function on the External MIDI Instrument device.**



**2. Select the first MIDI CC# you want to control or record by clicking the up/down CC Assign arrow buttons.**



**3. Right-click the CC Assign knob and select Edit Remote Override Mapping...**

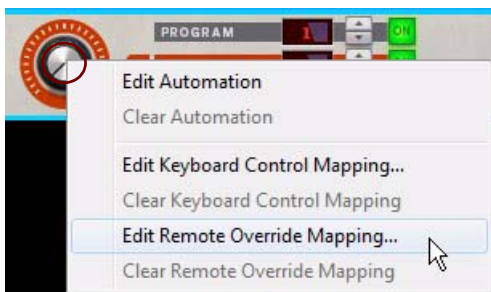

#### 4. Move a knob or slider on your controller.

Reason automatically detects which knob/slider you move and assigns this to the selected MIDI CC#:

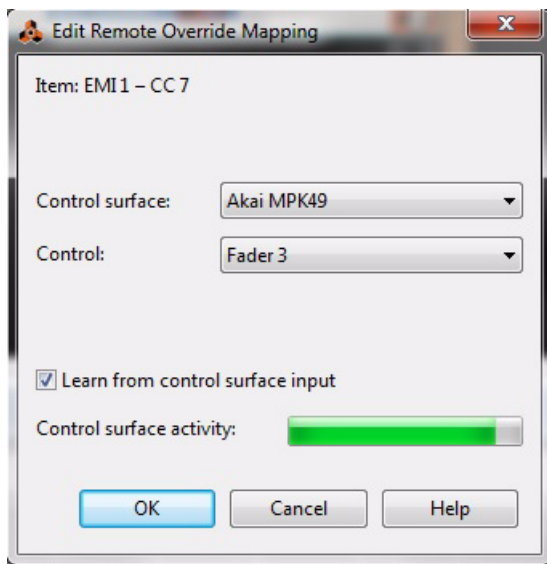

*Fader 3 on the control surface keyboard assigned to MIDI CC#7.*

#### 5. Click OK.

You have now mapped that knob or slider to the MIDI CC# you selected in step 2.

#### 6. Repeat the procedure from Steps 2-5 to assign other MIDI CC# to other knobs/sliders of your keyboard controller.

This way you can map all the controls on your keyboard or control surface to different MIDI CC# if you like.

When you're done mapping, you can record parameter automation by clicking Record in the sequencer and moving the assigned knobs and sliders on your MIDI keyboard/control surface.

### Recording MIDI Controller automation from the controlled MIDI instrument

If your MIDI instrument has a panel with knobs/buttons/sliders etc. that can send MIDI Controller data, you might want to record the MIDI CC# automation from that panel instead of from Reason or from your control surface. To be able to do this, you have to add your MIDI instrument as a MIDI Control Keyboard in Reason. This can be done as follows:

1. **If you haven't already, connect a MIDI cable from your MIDI instrument's MIDI Out to a MIDI In jack on your computer's MIDI interface.**
2. **Make sure you have set your MIDI instrument to "MIDI Local Off" as well as disabled any MIDI "soft thru" so that you don't get any MIDI feedback loop.**  
Refer to the documentation of your MIDI instrument on how to do this.
3. **Open the Preferences dialog and click the Control Surfaces tab.**
4. **Click the Add button.**

**5. Select <Other> from the Manufacturer drop-down list:**

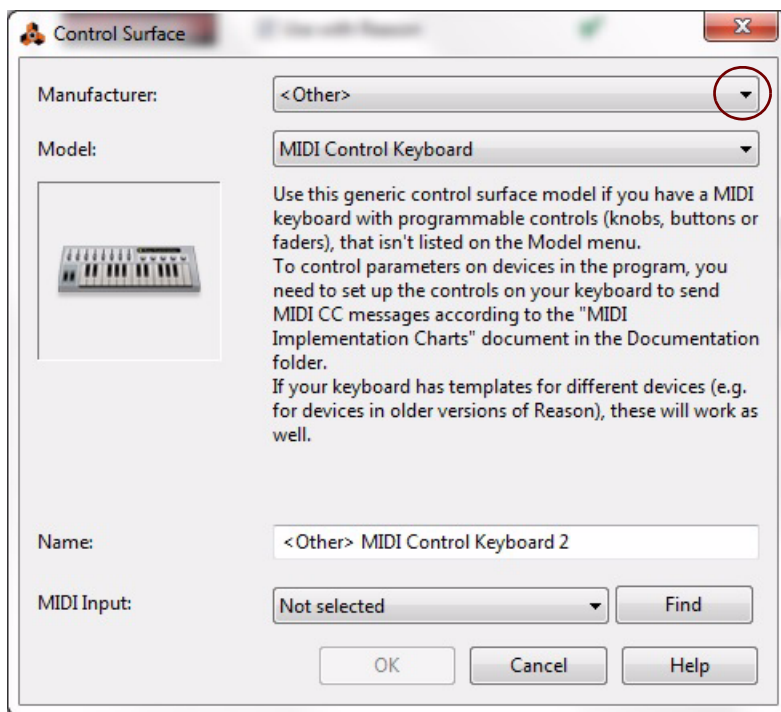

Selecting “<Other>” as Manufacturer automatically activates the generic MIDI map, which is designed to detect standard MIDI Note and Controller data, regardless of instrument model.

- **If your MIDI instrument has a keyboard, select “MIDI Control Keyboard” from the Model: drop-down list.** This way, you will be able to play MIDI Notes from your instrument as well as sending MIDI Controller data.
- **If your MIDI instrument is a rack instrument (without a keyboard), select “MIDI Control Surface” instead.**

**6. Select the appropriate MIDI Input from the “MIDI Input” drop-down list.**

Alternatively, click the “Find” button and turn a knob on your MIDI instrument. Reason will then auto-detect the correct MIDI In port and automatically select it.

## 7. Click OK.

Now, your MIDI instrument is shown in the “Attached surfaces:” list along with your other assigned control surfaces (if any):

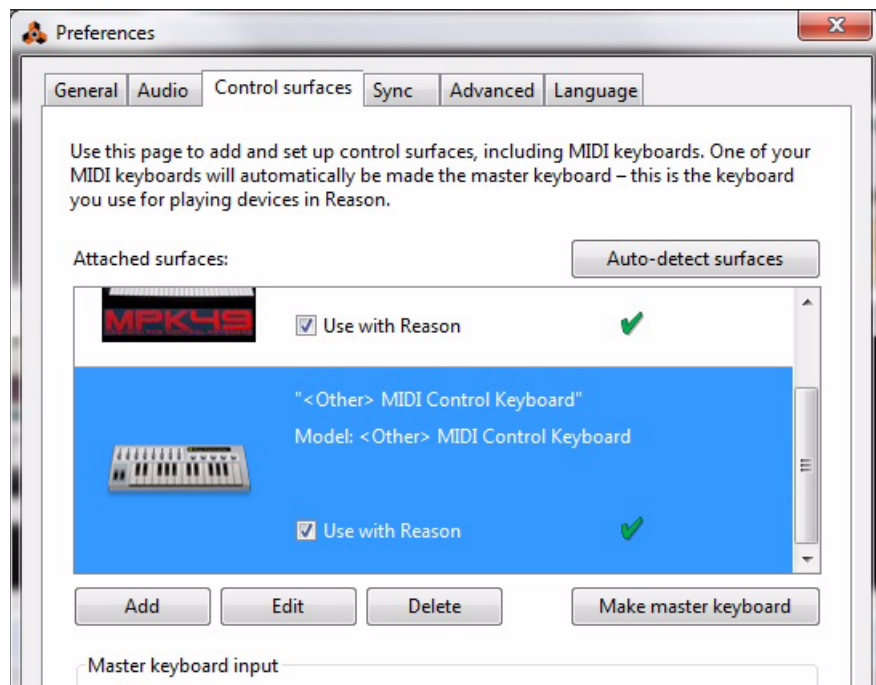

! Make sure the “Use with Reason” check box is selected and that the green check mark is present.

## 8. Now, select the External MIDI Instrument track in the sequencer and click the Record button on the Transport Panel.

If you turn or press a panel control (knob, slider, button, etc.) on your MIDI instrument during recording, each parameter will automatically create a new automation lane and record the corresponding MIDI CC data in a parameter automation clip, just like when you record parameter automation from an internal instrument device:

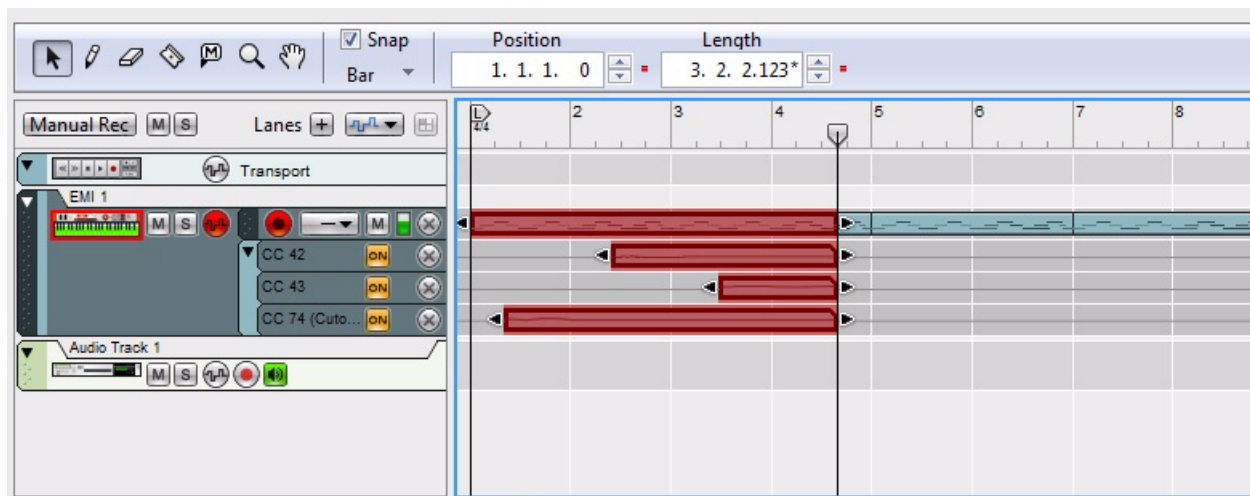

*Parameter automation recording from three knobs on the external MIDI instrument panel.*

! You might have to edit the parameter automation clips afterwards and set appropriate Static Values etc., see “Editing parameter automation in Edit Mode”.



# Connections



## Sequencer Control

The Sequencer Control CV In and Gate In inputs allow you to play the External MIDI Instrument device from another CV/Gate device (typically a Matrix or an RPG-8). The signal to the CV In controls the note pitch, while the signal to the Gate In delivers note on/off along with velocity. There are also inputs for modulating the Pitch Bend and Mod-Wheel parameters.

## Assignable CC

This CV input (with associated trim pot) can modulate the CC Assign knob. The affected MIDI Controller is defined with the CC Assign up/down arrow buttons, see [“Recording MIDI Controller automation”](#).

! **Note that only positive unipolar CV values are detected and transmitted to the CC Assign knob. Negative CV values are disregarded.**

## Tips & Tricks

### Audio recording of MIDI controlled external instruments

At some point you will probably want to record the audio from your MIDI controlled instrument onto an audio track in the Reason sequencer. The example below assumes that you have already recorded the note clips that control your MIDI instrument on an External MIDI Instrument track in the sequencer.

! **Depending on how you are monitoring the audio when you are recording, there will be different audio latency times, see [“Recording Latency Compensation”](#).**

1. **If you haven't already, connect your MIDI instrument's audio output(s) to the desired audio input(s) on the audio interface you are using with Reason.**
2. **Create an Audio Track in the sequencer.**
3. **Select the appropriate audio interface input(s) in the “Select Audio Input” drop-down list in the sequencer track list:**

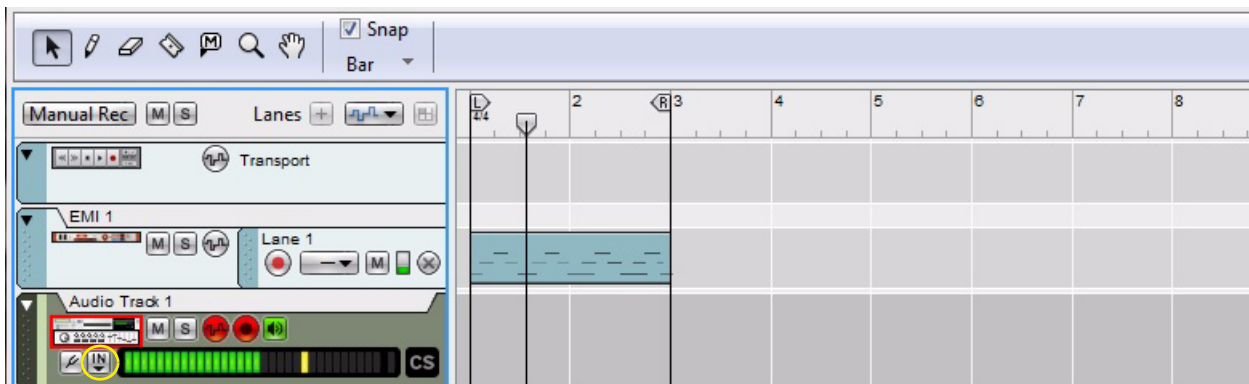

**4. Play back the song and adjust the audio level on your external MIDI instrument and/or the audio interface gain.**

To be on the safe side, leave around 12dB of headroom below the clipping level (first yellow LED lit on the Input Level Meter on the Audio Track):

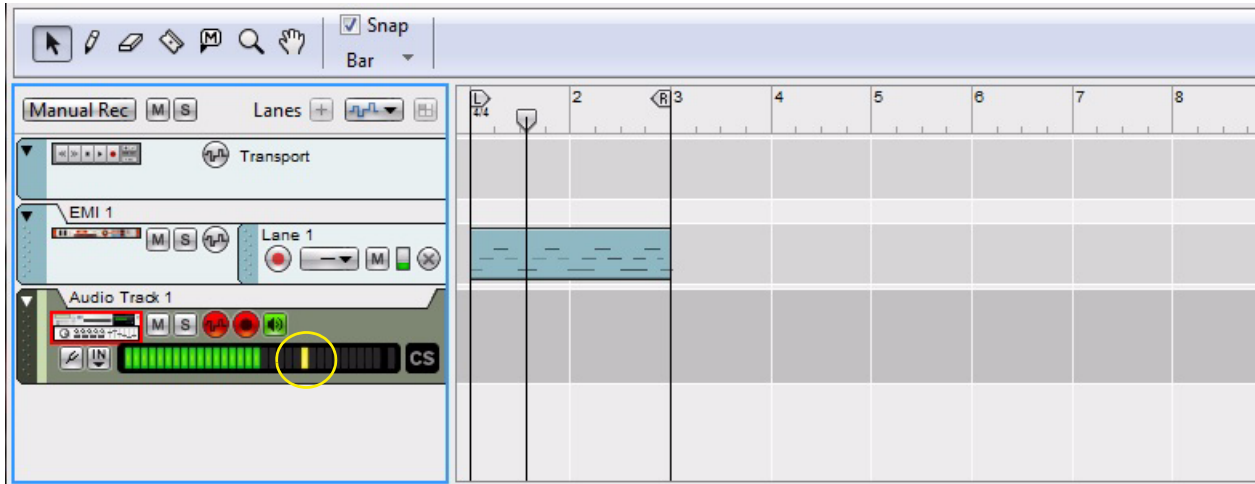

- You might also have to move (or nudge) the MIDI clips on the External MIDI Instrument track back slightly to compensate for any MIDI latency. Alternatively, you could slide all the notes in the clip back using the ReGroove Mixer, see [“Using the ReGroove Mixer for MIDI latency compensation”](#).
- If you don't want to adjust the MIDI notes beforehand to compensate for MIDI latency, you could move all Slice Markers in the audio clip after recording (see the tip below) or try quantizing the audio clips. MIDI latency mainly occurs in the MIDI interface and in the connected MIDI instruments and is nothing Reason can automatically compensate for. Refer to [“Moving clips”](#) for more information.

**5. Make sure the Audio Track is enabled for recording and then click Record in the sequencer to start recording the audio from your MIDI instrument.**

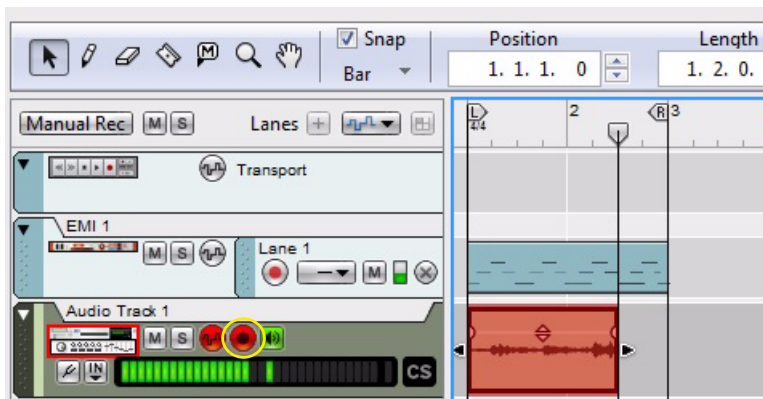

**6. When you are finished with the audio recording, click Play to play back the recorded audio.**

**!** If you are monitoring your external instrument externally, you will want to mute the External MIDI Instrument track so that you don't get double notes or phasing problems during playback.

If you are monitoring your external instrument only internally in Reason, there is no need to mute the External MIDI Instrument track. During playback, the monitor function on the audio track is automatically disabled, and only the recorded audio on the audio track is output.

- If you are experiencing problems with MIDI latency, i.e. the audio is recorded a little late in the audio clips, a good thing to try is to quantize the audio clips after recording, see [“Quantizing audio”](#).

- If quantizing the audio clip isn't applicable (e.g. due to playing style or type of sound), open the clip inline, select all Slice Markers and move them slightly to the left in the clip (with Snap off) so that the first note/beat aligns with the clip start. See the last example in **"Selecting Slices and Slice Markers"** for info about selecting and moving Slice Markers.

## Using the ReGroove Mixer for MIDI latency compensation

If you are experiencing MIDI latency when playing back recorded MIDI notes to your external instrument, you can compensate for this by using the Slide function in the ReGroove Mixer. This way you won't have to move or nudge the note clip(s) back before recording your external instrument onto an audio track in Reason.

1. Set up your external instrument according to the descriptions in steps 1-4 in **"Audio recording of MIDI controlled external instruments"**.
2. Make sure the Monitor button on the audio track is on.



3. Assign a ReGroove channel to the External MIDI Instrument track.

In this example we use ReGroove channel A1.



4. Make sure Click is on in the sequencer.

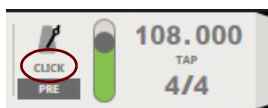

5. Play back the song and turn the Slide knob in channel A1 of the ReGroove Mixer counter-clockwise until your external instrument plays back in sync with the sequencer click.

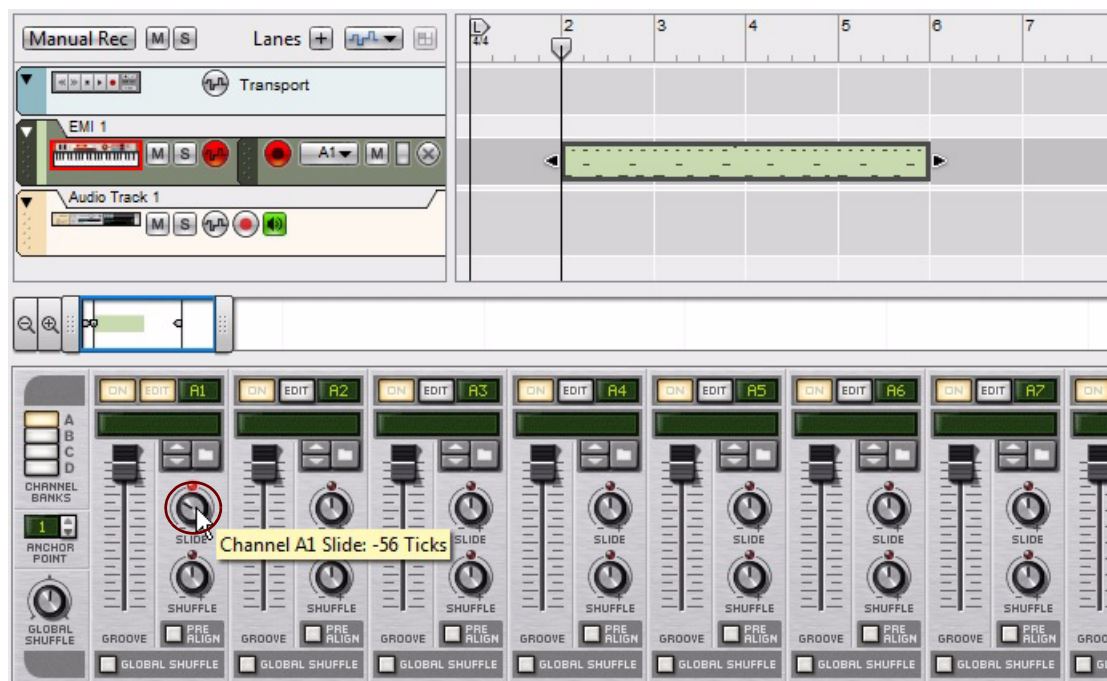

- ! **Note that the Ticks value you set with the Slide knob is tempo dependent. This means that if you raise the Tempo in the sequencer you will have to set the Slide knob to a lower (more negative) value to maintain the sync - and vice versa.**
- 6. Before you begin recording onto the audio track there is one important thing to keep in mind:**
- ! **If there are MIDI notes present exactly on the note clip start position you have to begin the audio recording before the note clip's start position.**

Since all notes in the note clip have been (invisibly) slid back by the ReGroove Mixer, it means that the first notes could be located before (outside) the note clip. To be able to record also these first notes, the audio recording have to begin before the note clip's start position. If your External MIDI Instrument note clip is placed at the very beginning of the song you will have to move all clips forward in the sequencer, so that the audio recording can begin earlier.

**7. Record your instrument onto the audio track.**

After recording, the audio should be on the track with perfect timing.

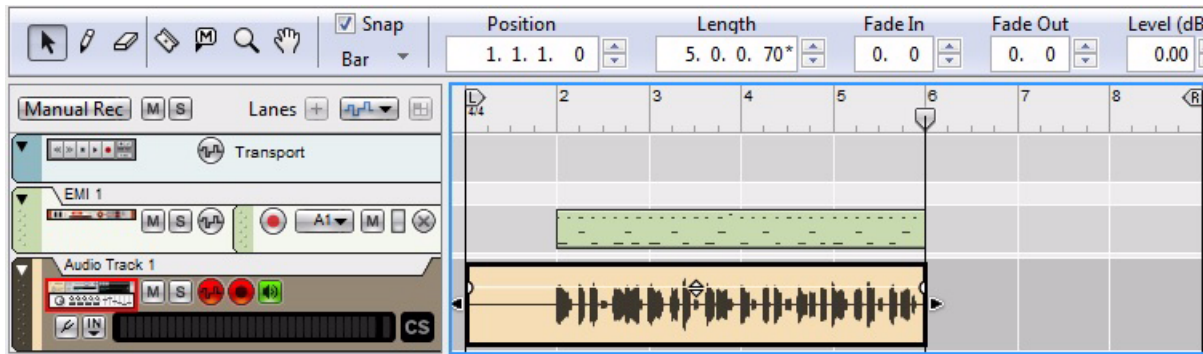

# **Chapter 38**

## **The MClass Effects**

# The MClass effects

The MClass effects package consists of four effect devices, which are available as separate devices from the Create menu and from the Devices tab in the Tool Window. There are also a number of Mastering Combi patches available in the Effects folder in the Factory Sound Bank. These mastering patches consist of all four MClass device types, patched together and organized as Combinator patches. The Mastering Combis are perfect to use as Master Insert FX in the Main Mixer to process the final mix. The individual MClass effects are as follows:

- **The MClass Equalizer - this has low and high shelving bands, two fully parametric bands and a low cut “anti-rumble” switch. See “The MClass Equalizer”.**
- **The MClass Stereo Imager - this can be used to control the stereo width for the high and low frequency ranges separately. See “The MClass Stereo Imager”.**
- **The MClass Compressor - this single band compressor features sidechain input and program-adaptive release. See “The MClass Compressor”.**
- **The MClass Maximizer is a special limiter tailored for loudness maximizing without risk of clipping. See “The MClass Maximizer”.**

## Common effect device parameters

While the specific parameters for the MClass effect devices are described below, some features and procedures are common to all effect devices. Please, refer to “Common effect device features” for information about the Input meter, the Bypass/On/Off switch and Signal Flow Graphs on the effect devices.

# The MClass Equalizer



The MClass Equalizer consists of two independent, fully parametric bands plus high and low shelving bands and a lo cut switch.

This is most often used as an insert effect, in mono or stereo.

## Activating the separate EQ bands

The separate bands are organized as vertical strips on the panel, in the following order (from left to right): Lo Cut/Lo Shelf/Parametric 1/Parametric 2/Hi Shelf.

You activate the separate bands by clicking the button at the top of each strip (none of the bands are activated by default).

## Lo Cut

The Lo Cut switch will simply cut frequencies below 30 Hz (by 12 dB/Octave). This is useful for removing low frequency “rumble”.

- **When you are using the MClass Equalizer with a compressor or Maximizer, activating the Lo Cut switch prevents subsonic sound from “topping” the compressor/limiter, and allows them to operate as efficiently as possible.**

## Parametric 1-2 parameters

A parametric equalizer will boost or cut frequencies around the selected frequency. The following parameters are available for both the parametric bands:

Parameter	Description
Frequency	This determines the center frequency of the EQ, i.e. at which frequency the level should be decreased or increased. The range is 39 Hz to 20 kHz.
Gain	Specifies how much the level of the selected frequency range should be boosted or cut. The gain range is $\pm 18$ dB.
Q	This governs the width of the affected area around the set center frequency. The higher the value, the narrower the affected frequency range.

## Lo/Hi Shelf parameters

A shelving equalizer will boost or cut frequencies below or above the selected frequency.

The following parameters are available for the Lo/Hi Shelf bands:

Parameter	Description
Frequency	Frequencies below (Lo Shelf) or above (Hi Shelf) the selected frequency will be boosted or cut. <ul style="list-style-type: none"><li>• The Lo Shelf range is 30 Hz to 600 Hz.</li><li>• The Hi Shelf range is 3 kHz to 12 kHz.</li></ul>
Gain	Specifies how much the level should be boosted or cut. The gain range is $\pm 18$ dB.
Q	This governs the slope of the shelving curve. The higher the value, the steeper the curve slope. High Q settings will also produce a “bump” in the opposite cut/boost direction at the set frequency.

## About the graphic display

The graphic display to the left in the device panel shows the frequency response curve as set by the EQ parameters. This gives a visual feedback and helps you tailor the EQ settings.

## The MClass Stereo Imager



The MClass Stereo Imager splits the signal into two frequency bands; “Hi” and “Lo” and allows you to widen or narrow the stereo image of each band. A typical application of the Stereo Imager is to widen the higher frequencies and narrow the lower frequencies. This will make the bass end “tight” whilst “opening up” the higher frequencies.

This is most often used as an insert effect in stereo.

**! The MClass Stereo Imager does not create stereo from mono input! For the device to work properly it must be connected with stereo in/out, and the input signal must contain a stereo audio signal.**

## Parameters

The following parameters are available:

Parameter	Description
X-Over Frequency	This determines the crossover frequency between the Hi and Lo band. Range is 100 Hz - 6 kHz. Frequencies below this will be affected by the Lo Width setting; frequencies above will be affected by the Hi Width setting.
Lo Width	This adjusts the stereo width for the Lo band. Turn anti-clockwise to narrow the stereo width (i.e. to make it more “mono”), and clockwise to widen the stereo image. Center position means no change from original signal. The “Active” LED indicates whether Low Width is activated or not. Note that for the Lo band, it is more common to narrow the stereo image, as the low frequency content in a mix is usually mixed center and can become less defined if widened.
Hi Width	This adjusts the stereo width for the Hi band. Turn anti-clockwise to narrow the stereo width (i.e. to make it more “mono”), and clockwise to widen the stereo image. Center position means no change from original signal. The “Active” LED indicates whether Hi Width is activated or not.
Solo switch	This allows you to listen to the Lo and Hi bands separately, for reference purposes. “Normal” is the standard operating mode.



## Connections



Apart from standard L/R inputs and outputs, there are also “Separate” L/R outputs on the back panel. The Separate outputs can either carry the Lo or Hi band output, which is set by the switch beside the outputs. These outputs can be used to apply processing separately to either the Lo or Hi band.

- If you set the Solo switch to “Lo” and the Separate output switch to “Hi”, the device will operate as a basic crossover filter, delivering the Lo band signal from the main output and the Hi band signal from the Separate out.

## The MClass Compressor



This is a single-band compressor capable of everything from subtle compression to aggressive pumping effects. Like all dynamics processors it is best used as an insert effect.

The features include “soft-knee” compression for more musical and unobtrusive compression, program-adaptive release time and a sidechain input for de-essing and other dynamics processing. Additionally, you have a CV output, allowing you to have the amount of gain reduction control other Reason parameters.

### Parameters:

Parameter	Description
Input Gain	The Input Gain controls the "drive" of the compression. This determines how much compression the signal will have in conjunction with the Threshold. Range: $\pm 12$ dB.
Threshold	This sets the level at which onset of compression occurs. When the input level is below the Threshold setting the signal is unaffected. When the input level exceeds the threshold, compression kicks in. In practice, this means that the lower the Threshold setting (and the higher the Input Gain), the more compression will be applied. Range: -36 dB to 0 dB
Soft Knee	Normally signals above the threshold will be compressed immediately at whatever ratio is set. This can be very noticeable, especially when using high compression ratios. When Soft Knee is activated, the onset of compression will be more gradual, producing a less drastic result.
Ratio	This lets you specify the amount of gain reduction applied to the signals above the set threshold. The Ratio can be set from 1:1 (no reduction) to $\infty$ :1 (Infinite).
Gain meter	This shows the amount of gain reduction (in dB).
Solo Sidechain	This allows you to monitor the signal connected to the sidechain input (see below).
Attack	This governs how quickly the compressor will apply its effect when signals rise above the set threshold. If you raise this value, the response will be slower, allowing more of the signal to pass through the compressor unaffected. Typically, this is used for preserving the attacks of the sounds. Range: 1ms to 100ms.
Release	When the signal level drops below the set threshold, this determines how long it takes before the compressor lets the sound through unaffected. Set this to short values for intense, "pumping" compressor effects, or to longer values for a smoother change of the dynamics. Range: 50ms to 600ms.
Adapt Release	When this is used, set Release to the time you want for short peaks - when longer peaks occur, the Release time is automatically increased.
Output Gain	This controls the output gain and can be used to compensate for the gain reduction caused by compression. Range: $\pm 12$ dB.

## About the Sidechain inputs

- **When a signal is connected to the Sidechain inputs, it is this signal that will trigger the compression.**  
This signal is not passed to the compressor output, and will thus not be heard (unless Sidechain Solo is activated).
- **The signal connected to the normal L/R inputs is the signal that will be processed by the compressor (as usual).**

Here follows two examples of how you can use sidechain processing:

### Example 1 - using the Sidechain inputs to create ducking effects

“Ducking” is when the level of one signal is reduced by the presence of another signal. A typical application is to automatically lower the level of a musical bed when a voice-over starts, and to automatically bring the level up when the voice-over stops. To set this up, we can name the musical bed in the example “Device A”, and the voice-over “Device B”. Proceed as follows:

**1. Connect Device A and Device B to separate channels on a mixer device.**

In this example the signal produced by Device A should be continuous, and the signal produced by Device B should be intermittent, i.e. it should contain both silent passages and signal passages.

**2. Select Device A and then select an MClass compressor from the Create menu.**

The effect will be auto-routed as an insert effect to Device A.

**3. Connect a Send on the mixer device to the Sidechain inputs on the MClass compressor.**

As soon as anything is connected to the Sidechain inputs, the “Active” indicator lights up on the device panel. The compressor will no longer react to the signal produced by Device A.



**4. Turn up the corresponding AUX Send level for Device B on the mixer.**

This means that the Device B signal now feeds both the mixer's input, and the sidechain input on the compressor, which in turn triggers the gain reduction.

**5. If you now start playback of both devices, the level of Device A will be lowered whenever Device B sounds, and be raised again when Device B stops.**

The amount of gain reduction, how quickly it lowers the level, and the time it takes for the level to return to normal again is determined by the corresponding Gain/Threshold/Ratio and Attack/Release parameters.

### Example 2 - using the Sidechain inputs to create frequency sensitive compression

By inserting an equalized signal to the sidechain inputs you can make the compression more or less sensitive to a certain frequency range. A typical application of this is “de-essing” - where harsh “S”-sounds in vocal material is reduced or eliminated.

Frequency sensitive compression is set up as follows:

**1. Hold down [Shift] and create an instrument device.**

Pressing [Shift] means no auto-routing connections to/from the device are made.

**2. Hold down [Shift] and create a MClass Equalizer.**

**3. Hold down [Shift] and create a MClass Compressor.**

**4. Create a Spider Audio Merger and Splitter device.**

**5. Connect the outputs of the instrument device to the A and B inputs on the Spider.**

6. Route one pair of the split outputs of the Spider to the MClass Equalizer inputs.
7. Route the Equalizer outputs to the Sidechain inputs on the MClass Compressor.
8. Route another pair of the split outputs of the Spider to the MClass Compressor.

Now, the compressors normal audio inputs are fed the unprocessed signal, and the sidechain inputs are fed the equalized signal.



9. Next, route the outputs of the Compressor to inputs on a mixer device.
10. Activate the Solo Sidechain button on the compressor's front panel.  
You will now only hear the equalized signal.
11. Now use the parameters on the MClass Equalizer to boost the frequencies you wish should trigger the gain reduction and cut the frequencies you wish to avoid triggering the gain reduction.  
You can use rather extreme eq settings - the signal will not be heard when Solo Sidechain is deactivated anyway. E.g. for de-essing you should separate and boost the offending "S" frequencies as much as possible.
12. Deactivate Solo Sidechain when you have finished tweaking the equalizer.

Now, the compressor will be more sensitive to the frequency area you tuned in with the equalizer, and thus react more to these frequencies. Note, however, that the whole signal will still be compressed - not just the boosted frequencies - so in case of de-essing you should usually use fast Attack and Release settings so that the gain reduction does not affect the rest of the program too much.

## CV Outs

On the back of the MClass Compressor you can find a "Gain Reduction" CV out connector. This can be used to modulate other parameters with the amount of gain reduction applied by the compressor. This means that the compressor works as an envelope follower. You could for example have the audio signal level control pan in a mixer or a synth parameter.

# The MClass Maximizer



This is a loudness maximizer, a special type of limiter which can significantly raise the perceived loudness of a mix without risk of hard clipping distortion. Features include a 4 ms look ahead function for “brick wall” limiting and a Soft Clip function.

The MClass Maximizer should be used as an insert effect, and is designed to be placed at the end of the signal chain between the mixed final output and the Hardware Interface.

## Parameters

Parameter	Description
Input Gain	The Input Gain sets the basic volume of a mix. If this is set very high, you should use Look Ahead mode or the Soft Clip function to eliminate the risk of hard clipping distortion. Range: $\pm 12$ dB.
Limiter On/Off	This turns the Limiter section on or off.
Look Ahead On/Off	If activated, this will introduce a very short delay (4 ms) to the signal. This delay is used to detect peaks in the signal before they actually occur. If high peaks are detected the limiter is “ready for them” and gain reduction is applied to transparently control the peaks.
Attack (Fast/Mid/Slow)	This governs how quickly the Limiter will apply its effect. If set to Fast with Look Ahead activated (and the Output Gain is set to 0 dB) you will get “brick wall” limiting - no signal peaks over 0 dB will pass.
Release (Fast/Slow/Auto)	This determines how long it takes before the Limiter lets the sound through unaffected. If Auto is activated, the Release time will automatically adapt to the program material.
Output Gain	This controls the output gain and should normally be set to 0 dB.
Soft Clip On/Off	If this is activated, it also acts a 0 dB brick wall limiter but in a slightly different way. The signal will be “soft-clipped” which adds a pleasant, warm sounding distortion to the signal. It can be used simply to get this effect, or as a safeguard against hard clipping distortion if Look Ahead with Mid or Slow attack settings are used (or if Look Ahead is deactivated).
Soft Clip Amount	This controls the amount of soft-clipping distortion. Note that if Soft Clip is on but the Amount is set to zero, the distortion will be like hard clipping, and thus less pleasing to the ear.
Output level meter (Peak/VU)	This is a more detailed meter than found on the mixer. You can switch the meter characteristics between Peak (faster response to peaks) and VU mode (average levels).

# **Chapter 39**

## **Line 6 Amps**

# Introduction



*The Line 6 Guitar Amp at the top and the Line 6 Bass Amp at the bottom*

The Line 6 Guitar Amp and Bass Amp are amplifier and speaker cabinet simulators based on the renowned modeling algorithms developed by Line 6. The two devices feature accurate simulations of five of the most coveted vintage amplifier and cabinet models, that you can freely mix and match. Setting up a great amp tone for your guitar or bass is easy, regardless of what type of sound you are looking for.

In addition, if you have a Line 6 device with a USB connection (POD etc.) hooked up to your computer you can also use any of the Amp/Cab models in that particular device from within the Line 6 Amps - see [“Additional Line 6 Amp Models”](#).

The Line 6 Guitar Amp and Bass Amp are virtually identical as they share the same Amp/Cabinet algorithms as well as most of the parameters. However, the preset patches for each device are geared towards processing either guitar or bass, respectively, and there are a few other slight parameter differences.

In this chapter the two devices will be described together using the collective name “Line 6 Amps”. Where parameters differ between the two devices this will be duly noted.

## About the Amp Tones patch format

Patches (or “Amp Tones”) are saved with the file extension “.l6t”. Although they use the same file extension, Guitar Amp Tones and Bass Amp Tones are different patch types and a saved patch always belongs to the Amp type (Guitar or Bass) it was saved with.

Loading patches is described in [“Selecting Patches \(Amp Tones\)”](#). Saving patches is done in the same way as for other effect devices - see [“Saving patches”](#).

**! The Line 6 Amp devices in Reason will always save Tones in the Pod Farm 2 format. These Tones cannot be opened for editing in Pod Farm 1 - you need to use Pod Farm 2 or later.**

## Basic usage

The Line 6 Amps can be used to process any signal but are best used “live”, i.e. as insert effects on the Audio Track Channel that a live instrument is connected to, so that you can monitor the effect as you play and record.

When recording electric guitar or bass, the basic tonal character of the amp/cabinet very much affects how the instrument responds, which in turn affects your playing. The Line 6 Amps allow you to set up a good basic tone with a minimum of fuss so you can start recording straight away!

Using a “real” amp requires that you set up the amp tone exactly right prior to recording, as you have very limited means of changing it afterwards. But as Insert FX are transparent in Reason (i.e. they are not a part of the recorded signal) you can tweak the tone, change Amp model etc., as much as you like after recording, right up to the creation of the final mixdown audio file (or Mixer Channel bouncing).

## Important note about using the Line 6 amps as insert effects

- **To use a Line 6 Amp as an insert fx when you're recording an audio track, you need to monitor through Reason (see “[Monitoring](#)”) - otherwise you won't hear the sound of the Line 6 Amp during recording.**

For this to feel comfortable you will want as low latency as possible (see “[Buffer Size settings](#)”). With good audio hardware and drivers, you can usually get down to a latency of a few milliseconds, which is about the same delay you'd get standing a meter from a real guitar amplifier.

## Front panel

The Line 6 Amps front panel can be divided into two main sections; the display area with Patch/Amp/Cabinet selectors and a set of standard amplifier tone controls to the right. The Amp parameters (tone controls) are described in “[Amp Parameters](#)”.

In addition, the Guitar Amp has Pedal controls for Volume and Wah (see “[Pedal controls \(Guitar Amp only\)](#)”), and the Bass Amp features a compressor (see “[Compressor \(Bass Amp only\)](#)”).

## Common effect device parameters

While the specific parameters for the Line 6 Amps are described later in this chapter, some features and procedures are common to all effect devices. Please, refer to “[Common effect device features](#)” for information about the Input meter, the Bypass/On/Off switch and Signal Flow Graphs on the Line 6 Amps.

# Using the Line 6 Amps

## Selecting Patches (Amp Tones)

Amp Tones contain all panel settings as saved. There are many available Amp Tones in the Sound Bank Effects folder, divided into Guitar Amp Tone and Bass Amp Tone categories. As mentioned previously, these are different patch types and are not compatible.

**1. To load an Amp Tone, click on the Browse Patch button to set browse focus and open the Browser.**



**2. Select the desired Amp Tone patch and click the Load button in the Browser.**

→ **Alternatively, drag an Amp Tone patch from the Browser and drop it on the Line6 device panel.**

The panel is dimmed in orange and a Patch Replace symbol appears in the center.

→ **You can also click on the patch name in the Amp display and select Amp Tones in the currently used folder directly from the list.**

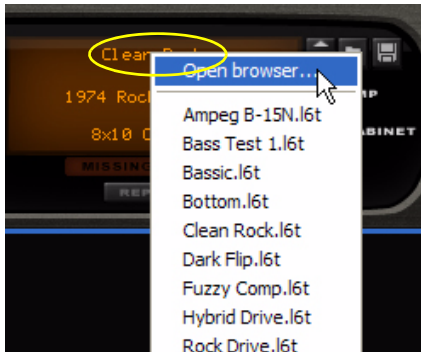

Alternatively, select "Open Browser" and choose Amp Tone using the Patch Browser. In the Patch Browser you can preview available Amp Tones before loading them.

→ **You can also click the Up/Down arrow buttons to the right of the Amp Tone name to step through the currently used folder and select a new Amp Tone.**



→ **Line 6 software such as POD Farm comes with a huge number of Tones, by default installed in the Documents folder of your user account. The majority of these Tones can be loaded in Reason's Line 6 Amp devices! If a loaded Tone refers to an Amp or effect model that you don't have access to, it will be substituted - see **"About Missing Models" and the "Replace" function**."**



## Selecting Amp and Cabinet model

There are five basic Amp models to choose from; three Guitar Amp models and two Bass Amp models. Each Amp model has an associated “matching” Cabinet model, although this relationship is not fixed - you can use any amp with any cabinet. For general model descriptions see [“About the Amp/Cabinet models”](#).

### Selecting Amp model

- To switch Amp model, click in the middle row of the display and select a model from either the Guitar Amp or Bass Amp model sub-menus.



- You can also use the Amp selector buttons to the right of the display to step through all the available Amp models.



When you change Amp model the following applies:

- **Changing Amp model also automatically changes the Cabinet to the default model for the selected Amp.**  
You can however freely change Cabinet model for any selected Amp - see below.
- **Amp parameter settings are also reset to their default settings for the selected Amp.**  
Changing the Amp model alters the tone drastically so the Amp parameters will usually have to be tweaked as Amp parameter settings for one Amp model are not necessarily suitable for a different model. The default Amp parameter settings are optimized for each Amp model.
- **In case you have made unsaved changes to any Amp parameters and then change the Amp model these parameters remain unchanged.**  
This protects you from accidentally losing any unsaved parameter settings when changing Amp model. Alternatively, if you want to keep parameter settings static when switching between Amp models you can simply manually set these parameters without saving them first. Note that if “No Amp” is selected all Amp parameters are reset to default values.
- **Any automated Amp parameters will remain automated (i.e. unchanged) when switching Amp model.**

### Selecting Cabinet model

You can use any Cabinet with any selected Amp model.

- To switch Cabinet model, click in the bottom row of the display and select a model from either the Guitar or Bass Cabinet model folders.
- You can also use the Cabinet selector buttons to the right to step through all the available models.

## About the Amp/Cabinet models

The Amp models are listed together with the default Cabinet models but remember that amps & cabs can be combined in any configuration. And don't feel bound by the Guitar/Bass categories - e.g. try a guitar amp with a bass cabinet for a bass, or use any other mix of Amp/Cab/instrument you like!

The following Amp and Cabinet models are available:

Amp Model	Description	Cabinet
1964 Blackface 'Lux (Guitar Amp)	This versatile amp can generate warm, clean tones with a subtle crunch which makes it perfect for a variety of styles ranging from rootsy blues to sparkly pop.	1x12 1964 Blackface 'Lux/ Single speaker combo cabinet.
1968 Plexi Lead 100 (Guitar Amp)	Based on one of the best amps ever produced. The signum sound is rich crunch with excellent dynamic response. if you're looking for classic rock tone, look no further.	4x12 1968 Green 25s/ 4x12 cabinet with classic speakers.
2001 Treadplate Dual (Guitar Amp)	This is a high gain amp with a cutting tone. From clean to meltdown, this amp delivers.	4x12 2001 Treadplate/ Modern style 4x12 cabinet.
1974 Rock Classic (Bass Amp)	300 Watt powerhouse amp with awesome punch and big sound. The amp of choice for many rock bassists.	8x10 Classic/ Big cabinet with rock solid bass.
1968 Flip Top (Bass Amp)	This relatively small (25 Watts) amp is based on one the world's most popular studio amps.	1x15 Flip Top/ Closed back cabinet design with a single 15" speaker. Great, tight bass tone.

## Amp Parameters

The Amp parameters are used to tweak the selected amp tone. The following controls are found in this section:

Parameter	Description
Drive control	This controls the input gain. The higher the Drive value, the more crunch you get.
Bass/Middle/Treble controls (Guitar Amp)	These are tone controls which you can use to cut or boost the bass, midrange and high frequencies, respectively.
Bass/Lo Mid/Hi Mid/Treble controls (Bass Amp)	The Bass Amp has both Lo and Hi Mid controls which give you more control over the important mid-range frequencies.
Presence control (Guitar Amp only)	Presence usually provides a boost of high frequencies, helping the sound cut through the mix.
Volume	Controls the master volume of the Amp.

## Additional parameters

### Pedal controls (Guitar Amp only)



Wah and Volume are pedal control parameters. The "Wah" (a resonant filter), and "Volume" (or swell) parameters are used to change tone and volume, respectively. Any suitable Remote control surface (e.g. a MIDI pedal) can be used to record pedal expression live if you so wish. There are also CV control inputs for these parameters.

→ **Activate both the Volume and Wah controls by clicking the "On" button.**

## Compressor (Bass Amp only)



This is a fixed ratio compressor optimized to “tighten up” the bass sound, i.e. to even out levels and increase punch and sustain. The Threshold control sets the level at which the onset of compression occurs. In practice, this means that the lower the Threshold setting, the more compression will be applied.

→ **Activate the Compressor by clicking the “On” button.**

## Additional Line 6 Amp Models

If you have a Line 6 USB hardware device connected to your computer, you can access all the Amp and Cabinet model in this device from within the Line 6 Guitar/Bass Amp in Reason. The additional amp/cab models will be listed together with the standard models and are selected and tweaked in the same way!

For the additional amp models to be available in Reason, two conditions must be met:

- **If it's the first time you use the Line 6 hardware with the computer, you need to authorize the hardware.**  
Run the Line 6 License Manager application and follow the instructions. The Line 6 License Manager application can be downloaded from <http://www.line6.com>.
- ! **if you are using an iLok key containing a license for POD Farm or POD Farm Platinum, all the licensed amp models will automatically be available in Reason - you don't have to perform any additional downloads or authorizations.**
- **If you have licenses for additional amp/effect models on your Line 6 account, you can authorize your computer to use these licenses with Reason.**  
Run the Line 6 License Manager application and follow the instructions.

You can also use Amp Tones created with other Line 6 devices (including effect models) in the Line 6 Amps. In the case of effects these will be heard but you will not be able to change parameter settings in Reason. You can, however, use software such as Line 6 POD Farm to change settings and then save it as an Amp Tone which can be used in the Line 6 Amps.

Line 6 hardware also feature various Preamp models which can be selected as Amp models in the Line 6 Amps. You may not have access to all parameters in Reason as these models have different Amp Parameters, but you can use the Line 6 POD Farm to make settings in the same way as with effects.

- **The Line 6 Amp devices in Reason load Tones of the Pod Farm 1 or Pod Farm 2 format.**
- ! **The Line 6 Amp devices in Reason will always save Tones in the Pod Farm 2 format. These Tones cannot be opened for editing in Pod Farm 1 - you need to use Pod Farm 2 or later.**

## About “Missing Models” and the “Replace” function

If you're opening a patch or a Song where additional Line 6 Amp Models are used, and you don't have any Line 6 hardware connected to your computer - or if you have Line 6 hardware connected, but the Patch or Song uses models from an optional Model Pack that haven't been installed in your hardware - the “Missing Line 6 Models” alert is shown:



→ Click “OK” to open the Song with the additional Amp Model temporarily replaced by a default Amp Model.

The Song opens with default Line 6 Amp Models instead. On the Line 6 Amp device(s), the “Missing Models” indicator is lit to indicate that you're currently using a replacement Amp Model.

As long as you don't change the model selection or click the “Replace” button (see below), you can go on working with the song and save it as usual. The information about the missing models is retained - if you later open the song with the right Line 6 hardware connected, the correct models will be used again.

If you want to permanently replace the missing Amp Model with the default model, you can easily do that.



→ Click the “Replace” button to permanently replace the missing Amp Model with the currently used default one.

The “Missing Models” indicator goes off and the Amp Model has been permanently replaced by the default model.

## Connections



- Both Line 6 Amps have Left/Right inputs and outputs.
- The Line 6 Guitar Amp also has CV inputs for controlling the Pedal parameters (Volume and Wah).
- For rhythmic auto-wah effects, try connecting the LFO CV output on a Thor or Subtractor to the Wah CV input on the Line6 Guitar Amp!

**Chapter 40**  
**Scream 4 Sound**  
**Destruction Unit**

# Scream 4 Sound Destruction Unit



Scream 4 is a very versatile stereo in/out sound destruction device, capable of warping any sound literally beyond recognition, but also capable of producing more subtle musical effects. Scream 4 features a wide range of algorithms for distortion and sound mangling which can be combined with an EQ and a resonant “Body” section to provide everything you need to add an edge to your sounds. This effect is most often used as an insert effect.

## About the Patch format

Unlike most of the other effect devices, Scream 4 features programmable effect presets. Included are a number of factory Patches which can be used as they are or provide you with a good starting point for further tweaking.

Patches use the Windows file extension “\*.SM4”. Loading and saving Patches is done in the same way as for instrument devices.

## Parameters

Scream 4 contains three main sections; Damage (distortion and other types of sound destruction), Cut (EQ) and Body (places the sound in a resonant environment - can serve as anything from a cabinet emulator to a wah-wah to completely new special effects) which can be switched on or off independently. The parameters in each section are as follows:

### Common effect device parameters

While the specific parameters for the Scream 4 effect device are described below, some features and procedures are common to all effect devices. Please, refer to [“Common effect device features”](#) for information about the Input meter, the Bypass/On/Off switch and Signal Flow Graphs on the effect device.

### Damage section controls



The “Damage” section is where you specify the basic sound mangling algorithm and make settings to inflict the desired amount of damage to the sound. There are ten basic algorithms to choose from, ranging from classic distortion effects to digital-sounding warping and modulation effects.

There are five controls in this section, with the following functions:

Parameter	Description
Damage button	This switches the Damage section on or off.
Damage Control knob	This controls the input gain which in turn determines the amount of damage inflicted. The higher the value, the more destruction! When raising the Damage Control you may need to lower the Master level to maintain the same output level (and vice versa).
Damage Type knob	This selects the type of effect - see the table below for a description of the available damage methods.
P1/P2 knobs	The functionality of these knobs vary according to the selected Damage Type - see the table below for a description.

## Description of the various Damage Type algorithms

Here follows a basic description of the ten Damage Types available, and what parameters the P1/P2 knobs control for each type:

Type	Description
Overdrive	This produces an analog-type overdrive effect. Overdrive is quite responsive to varying dynamics. Use lower Damage Control settings for more subtle "crunch" effects. - The P1 knob controls the basic tone of the effect. Turn clockwise for a brighter sound. - The P2 knob controls Presence. Presence boosts frequencies in the high midrange <i>before</i> the distortion stage which in turn affects the character of the distortion. Turn clockwise for more Presence boost.
Distortion	Similar to Overdrive, but produces denser, thicker distortion. The distortion is also more "even" across the Damage Control range compared to Overdrive. - The P1/P2 knobs control Tone and Presence, respectively - see Overdrive for a description.
Fuzz	Fuzz produces a bright and distorted sound even at low Damage Control settings. - The P1/P2 knobs control Tone and Presence, respectively - see Overdrive for a description.
Tube	This emulates tube distortion. - The P1 knob controls Contour, which is somewhat like a high pass filter, changing the tone and character of the distortion. - The P2 knob controls Bias, which changes the "symmetry" of the tube distortion. Setting this to the minimum or maximum value will produce asymmetrical distortion (typical of a real-life tube amplifier), while a 12 o'clock setting will produce symmetrical distortion (odd harmonics only).
Tape	This emulates the soft clipping distortion produced by magnetic tape saturation and also adds compression which adds "punch" to the sound. - The P1 knob controls Speed, which simulates tape running at different speeds. The higher the Speed setting the more of the original high frequency material in the signal. Turn clockwise for a brighter sound. - The P2 knob controls the amount of Compression. Turning the knob clockwise increases the compression ratio.
Feedback	This effect combines distortion in a feedback loop which can produce many interesting and sometimes unpredictable results. Feedback is basically when a sound source is fed back to itself. An open microphone picking up sound from a nearby loudspeaker that is also being used to amplify sound from the microphone will produce a feedback loop with the associated typical howling. For this effect the Damage Control knob controls the gain of the feedback loop. - The P1 knob controls Size, which could be described as the "length" (i.e. the distance between the microphone and the loudspeaker in the above example) of the feedback loop. - The P2 knob controls Frequency, which for this effect determines which overtones will "howl".
Modulate	Modulate first multiplies the signal with a filtered and compressed version of itself, and then adds distortion. This can produce resonant, ringing distortion effects. - The P1 knob controls Ring, which is the resonance of the filter. Turn clockwise for more pronounced ringing effects. - The P2 knob controls Frequency, which is the filter frequency. Turn clockwise to raise the filter frequency which generally produces a sharper, more piercing effect.

Type	Description
Warp	<p>Warp distorts and multiplies the incoming signal with itself.</p> <ul style="list-style-type: none"> <li>- The P1 knob controls Sharpness. Lower values will produce a soft, compressed distortion, while higher values produces more harmonics and a sharper sound.</li> <li>- An effect of multiplying a signal with itself is that the fundamental pitch is removed from the signal, leaving overtones only. The P2 knob controls Bias - raise this to reintroduce the fundamental pitch in the sound.</li> </ul>
Digital	<p>Lo-fi anyone? This reduces the bit resolution and sample rate for raw and dirty sounds or for emulating vintage digital gear.</p> <ul style="list-style-type: none"> <li>- The P1 knob controls (bit) Resolution. If the knob is turned fully to the right there is no bit reduction, fully the left the resolution is 1-bit.</li> <li>- The P2 knob controls the sample rate. If the knob is turned fully to the right the sample rate is not reduced; turning it to the left gradually reduces the sample rate.</li> </ul>
Scream	<p>Similar to Fuzz, but with a bandpass filter with high resonance and gain settings placed before the distortion stage.</p> <ul style="list-style-type: none"> <li>- The P1 knob controls the basic tone of the effect. Turn clockwise for a brighter sound.</li> <li>- The P2 knob controls the filter frequency. The high resonance setting of the filter makes it suitable for wah-wah effects.</li> </ul>

## Cut section (EQ)



The sliders in the Cut section are tone controls, allowing you to cut or boost the level by up to 18dB in the low, mid and high frequency areas. The Cut section is activated with the Cut button above the sliders.

Move the slider from the middle upwards to boost the level, and from the middle downwards to cut the level of the corresponding frequency area.

## Body section



The Body section is just what it says - it places the sound in a resonant “body”. Depending on the settings, the result can be similar to a speaker cabinet simulator, an auto-wah effect, or effects with no real-world counterpart. The section is based on 5 basic body types, which simulate how a sound is affected by different physical enclosures. The size and resonance of the Body types can be changed, and the section also features an envelope follower.



The Body parameters are as follows:

Parameter	Description
Body button	This switches the Body section on or off.
Body Type knob	This is used to select one of the five available Body types (A-E).
Body Reso knob	This simulates the resonance of the selected Body. Turning the knob clockwise gives a more resonant effect.
Body Scale	The Body Scale parameter could be said to control the "size" of the Body. Note that this is "inverted" - turning the knob clockwise reduces the emulated size.
Auto knob	Determines the amount of envelope follower effect on the Scale parameter - see below.

## About the envelope follower

The Body section features an envelope follower for dynamic control of the Scale parameter. The envelope follower analyzes the amplitude of the incoming signal and changes the Scale setting accordingly - the louder the incoming signal the higher the value of the Scale parameter. The operating frequency (or size) range is set with the Scale parameter, and the envelope follower amount is set with the Auto parameter. A typical use for this is auto-wah effects - try Body Type "B" for a pronounced wah effect.

- **On the back of the Scream 4 you will find an Auto CV output - this delivers the CV signal from the envelope follower, allowing you to dynamically control parameters in other devices. See ["Creating a real dynamic wah effect with the envelope follower"](#) for an example.**

## About the Master level control



The Master level control should be used when you need to increase or decrease the output level, while retaining the basic character of the effect. It can also be used to balance the level between the distorted sound and the "clean" (unprocessed) sound if the effect is to be switched in and out in the mix.

If the output level is too high, turning down the Damage Control setting would lower the output, but it would also change the character of the distortion, as would changing eq or presence settings.

Simply lowering the mixer channel level (for the channel that Scream 4 is connected to) would also work of course, but this would also mean that the level difference between the unprocessed and processed sound would increase.

So if the clip indicator lights up on the Transport, or if the distorted sound is too loud compared to the normal sound, the solution is to lower the Master output level.

As pointed out elsewhere in the manual, audio out clipping (indicated by the red clip indicator lighting up on the Transport Panel) can only happen in the Reason Hardware Interface. In other words, you never have to worry about levels passed internally from device to device. However, bear in mind that if you use high Master output settings (or a lot of boost in the Cut section) Scream 4 can quite easily cause audio out clipping - and that is most likely not a distortion effect you want!

## CV inputs and outputs



On the back of the Scream 4 you will find CV inputs for controlling the following four parameters:

→ **Damage Control**

Use this for dynamically changing the amount of damage effect.

→ **P1**

The use for this depends on the selected Damage Type. For example, if the Feedback effect is selected, this will control the Size parameter - connect it to the CV Out on a Matrix or synth LFO for strange, flanger-like sweeps.

→ **P2**

The use for this depends on the selected Damage Type. For example, if the Scream effect is selected, this will control the Frequency parameter, producing a distorted wah wah sound.

→ **Scale**

Lets you control the Scale parameter in the Body section from another CV source, for wah wah-like effects, etc.

In addition, you find a CV output from the "Auto" (envelope follower) function in the Body section. By connecting this to a CV input for a parameter in another device, the level of the signal going into the Scream 4 will affect that parameter. See below for an example on how to use this.

## Screamy tips and tricks

Don't restrict yourself to using Scream 4 as a basic distortion stompbox, but try it in as many ways as possible - you may be surprised to find how often Scream 4 can add power, warmth and color to your sounds. Here are some examples:

### Creating a heavy drum sound

Scream 4 is ideal for processing drums. Try connecting it as an insert effect to a Redrum device and experiment with the Damage Types and settings.

- **For classic distorted drums, try the Tube, Tape or Distortion algorithms.**
- **The Scream algorithm is excellent for a really raw body or industrial drum sound.**
- **For more weird, synth-like effects, try the Modulation or Warp effects.**

Remember that you don't have to route the whole drum kit through the Scream device - sometimes it may be better to route the individual outputs from the bass drum, snare and/or toms to a Spider Audio Merger (see "[Spider Audio Merger & Splitter](#)"), connect the merged output of the Spider to the Scream 4 and route this to a separate channel in the Mixer. That way, hi-hats, cymbals and similar are unprocessed.

### Warming up a mix with the Tape effect

If you find your mixes a bit sterile, the Tape algorithm is excellent for providing some warmth and gentle distortion:

- 1. Create a Scream 4 device and connect it between the main outputs of the Mixer and the Audio Hardware device.**
- 2. Set the Damage Type to Tape.**  
Make sure the Cut and Body sections are turned off.
- 3. Start with a low Damage Control setting and P1 (Speed) and P2 (Compression) at 12 o'clock.**
- 4. Play back your mix and adjust the settings.**  
Raise the Damage Control for more tape saturation distortion, adjust P1 to get the desired brightness and raise P2 if you want a more controlled, compressed sound. If you like, you could also activate the Cut section and use the three-band EQ to further adjust the sound.

### Using the Body section as a sound enhancer/phaser/wah

Nothing stops you from using the Body section on its own, without Damage. Try this:

- 1. Create a sampler device (e.g. an NN-19) and select an electric piano patch.**
- 2. Select the sampler and create a Scream 4.**  
It is added as an insert effect.
- 3. Turn off the Damage section and instead activate the Body section.**

You will find that this adds a resonant character to the sound, which will make it more "alive" and help it stand out in a mix. You should experiment with the Body settings to find the character that suits you best. You could also activate the Cut section- if you e.g. find the sound too bassy, just lower the "Lo" slider a bit.

- 4. Now flip the rack around and connect the CV out from the sampler's LFO to the Scale CV input on the Scream 4.**  
As you can hear, the Scale is modulated by the LFO.
- 5. Adjust the amount of Scale modulation with the pot next to the CV input on the back of the Scream 4, and the speed (and waveform) of the modulation in the LFO section on the sampler device.**

With this type of modulation setup, it's easy to get lush, dreamy phaser effects. For a more wah wah-like sound, select Body type B and raise the Reso and Scale settings.

## Emulating vintage digital gear

The first generations of digital instruments (drum machines, synths and samplers) used 8 or 12 bit sampling and processing, at low sample rates. This “lo-fi” sound is still in high demand, e.g. in hip-hop and R’n’B. Try this:

- 1. Connect a Scream 4 as an insert for a Redrum, with a suitable kit selected.**
- 2. Set Damage Type to Digital and turn P1 and P2 fully right.**
- 3. Play back and lower P1 (bit depth) and P2 (sample rate) to get the sound you want.**

You may also want to use the Cut section to emphasize or cut frequencies in the sound.

## Creating a real dynamic wah effect with the envelope follower

As we have shown, you can get auto-wah-like effects with the Body section in Scream 4 (by using the Auto parameter). You could also use the ECF-42 envelope controlled filter and trigger this with a gate signal - this is after all a “real” filter and sounds even more like a wah effect. However, to get a “real” auto-wah effect that responds to the signal level, you need to combine both these devices:

- 1. Create an instrument device that you want to process with an auto-wah.**

It should be velocity responsive so that the harder you play, the louder it sounds.

- 2. Create a Scream 4 device and an ECF-42 device.**

Both these should now be connected as insert effects to the instrument device.

- 3. Turn off all three sections in the Scream 4.**

This is of course a matter of taste - but here we will show how to use the envelope follower in Scream 4, not its sound destruction capabilities.

- 4. Flip the rack around and connect the Auto CV Output on the Scream to the Freq CV input on the ECF-42.**

- 5. Lower the pot next to the CV input a bit - the envelope follower is rather sensitive and you probably don’t want the filter to open too much.**

You can adjust this later if needed.

- 6. On the ECF-42, select the BP 12 (bandpass) mode and set the Res setting rather high.**

- 7. Play the instrument device and adjust the Freq setting on the ECF-42 to taste.**

As you can hear, the harder (or the more notes) you play, the more the filter will open.

- **If you find the auto-wah too responsive, you could add a compressor between the instrument device and the Scream 4 to even out the level differences a bit.**
- **The Spider CV Merger and Splitter (see “[Spider CV Merger & Splitter](#)”) can be used to invert and split the Auto CV output for even greater flexibility.**

## Scream 4 sample rate issue

Some of the algorithms on the Scream 4 Distortion device do not have the expected effect when running Reason at a sample rate lower than 14 kHz (or exporting to a sample rate lower than 14 kHz). Please use a higher sample rate if your song contains Scream devices.

# **Chapter 41**

## **Pulveriser**

# Introduction



Pulveriser is a very versatile stereo in/out compression+distortion+filter device, capable of mangling any sound literally beyond recognition, but also capable of producing more subtle musical effects. Pulveriser features a wonderful compressor, coupled with a nice warm distortion, plus a multi-mode filter. The different sections of Pulveriser can be modulated by an LFO and by an Envelope Follower to allow for really organic modulation effects. Pulveriser also features a Dry/Wet mix control so you can utilize parallel processing in the unit itself, i.e. mix in the processed signal in parallel with the dry signal - great for parallel compression of drum loops etc.

## About the Patch format

Pulveriser features programmable effect presets. Included are a number of factory Patches which can be used as they are or provide you with a good starting point for further tweaking.

Patches use the file extension "\*.pulver". Loading and saving Patches is done in the same way as for instrument devices.

## Parameters

Pulveriser contains three main effect sections; Squash (compression), Dirt (distortion) and Filter (multi-mode filter with cutoff and resonance controls). In addition, Pulveriser features two modulation sections - an LFO with selectable waveforms and an Envelope Follower which can modulate the effect sections. The parameters in each section are as follows:

## Common effect device parameters

While the specific parameters for the Pulveriser effect device are described below, some features and procedures are common to all effect devices. Please, refer to "[Common effect device features](#)" for information about the Bypass/On/Off switch.

Note, however, that the Input Meter is different on the Pulveriser device. Instead of the standard multi-segment LED indicator found in other Reason effect devices, Pulveriser features a red lamp which reflects the intensity of the input signal.

# Signal Routing selector



With the Signal Routing selector to the bottom left on the front panel you determine the signal flow through Pulveriser:

- **Squash > Dirt > Filter**

This setting puts the compressor before the distortion and filter sections in series:



In this configuration the compressor and distortion affect the entire unfiltered input signal.

- **Filter > Squash > Dirt**

This setting puts the filter before the compressor and distortion sections in series:



In this configuration the compressor and distortion affect the filtered input signal. This way you can define what frequencies should enter the compressor and distortion sections.

## The Squash section



The Squash section is where you set the compression of the signal - from subtle compression to heavily “pumping” effects.

### Squash

The Squash knob affects compression ratio, threshold and make up gain in a nice and musical way.

### Release

The Release knob controls the compressor release time. If you set this to a fairly low value and have the Squash amount fairly high, you will get that nice “pumping” compression effect.

## The Dirt section



The Dirt section is where you can add distortion to the signal - from gentle to screaming outrage.

### Dirt

The Dirt knob controls the level of distortion.

### Tone

The Tone knob controls a lowpass filter. Turned fully clockwise the filter is completely open, letting all frequencies through.



# The Filter section



The Filter section features five different filter types. Each filter type has controls for Frequency and Peak (resonance amount).

## Filter selector

Select one of the following different filter types (or bypass):

- **Bypass**  
This will let the input signal through the Filter section unaffected.
- **Lowpass 24**  
This is a lowpass filter with a slope of 24dB/octave, similar to the LP24 lowpass filter in the Subtractor (see [“24 dB Lowpass \(LP 24\)”](#) in the Subtractor chapter).
- **LP12+Notch**  
This is a lowpass filter with a slope of 12dB/octave, in series with a notch filter. The cutoff frequency of the lowpass filter and the center frequency of the notch filter are the same. Changing the Frequency control will generate sort of an “animated” effect.
- **Band Pass**  
This is a bandpass filter similar to the BP12 filter in the Subtractor (see [“Bandpass \(BP 12\)”](#) in the Subtractor chapter).
- **High Pass**  
This is a highpass filter with a slope of 12dB/octave, similar to the HP12 filter in the Subtractor (see [“Highpass \(HP12\)”](#) in the Subtractor chapter).
- **Comb**  
This is a comb filter similar to the “Comb +” Filter in Malström (see [“Comb + & Comb -”](#) in the Malström chapter).

## Frequency

The Frequency knob controls the cutoff frequency or center frequency depending on selected filter type.

## Peak

The Peak knob controls the resonance amount.

## The Tremor section



The Tremor section in Pulveriser is an LFO which can modulate the Filter Frequency parameter and/or the main output Volume parameter. The Tremor section features the following parameters:

### Rate

Controls the LFO rate. The Rate range in Pulveriser is very wide and can reach way up in the audio frequency range. The rate can also be synced to the sequencer tempo by clicking the Sync button to the right (see “Sync” below). In sync mode, the Rate knob controls the sync resolution.

As a special feature, the rate can also be modulated from the envelope follower in the Follower section, see “The Follower section”.

### Waveform selector

Select one of nine LFO waveforms. Apart from standard waveforms (sine, triangle, square etc.) there are random, non-linear and stepped waveforms. The shape of the waveforms are shown in the display and reflect how the modulated signal is affected.

### Sync

Click the Sync button to synchronize the LFO Rate to the main sequencer tempo. In Sync mode the LFO cycle is also synced to the sequencer, which means that the LFO cycle chases the current sequencer position.

Control the sync resolution with the Rate knob, see “Rate” above.

### Spread

The Spread button introduces a stereo effect by modulating the left and right audio channels with two LFO signals phase shifted 180 degrees in relation to each other. This means that you are able to generate kind of a “rotospeaker” effect to the processed signal.

### Lag

The Lag control acts like a lowpass filter on the LFO signal, making the LFO signal smoother. This is especially noticeable on waveforms with sharp edges or transients like the square, sawtooth and stepped waves. On the sinewave you will barely notice any effect since it's already “smooth” by nature.

### Modulation Amount knobs

On either side of the Tremor section are two bipolar modulation amount knobs, with zero modulation at the 12 o'clock position. Since the modulation parameters are bipolar it means that if the knob is in the “-” sector it will invert the LFO wave shape. This is especially useful in LFO Sync mode where you can define the “direction” of the modulation in relation to the sequencer playhead.

- Turn the left knob to control the modulation of the Frequency parameter of the Filter section.
- Turn the right knob to control the modulation amount of the wet signal of the Volume parameter. This will introduce a tremolo effect to the Wet signal fed via the Volume control.
- ! Note that the Dry signal in the Blend section is never affected by the tremolo effect! This means that if the Blend knob is set to fully Dry, there won't be any tremolo effect of the volume.

## The Follower section



The Follower section features an envelope follower which analyzes the amplitude of the incoming signal and outputs a modulation (CV) signal that corresponds to the incoming audio level. The modulation signal can then control the Frequency parameter in the Filter section and/or the LFO Rate parameter in the Tremor section. The Follower section features the following parameters:

### Trig

Click/hold the Trig button to manually trig/gate the envelope follower. Clicking/holding the Trig button will make the envelope follower output a modulation signal according to the settings of the Attack and Release parameters described below. If you hold the Trig button for a longer period than the Attack time, the Follower will output maximum CV signal level. When you then release the Trig button, the CV signal level will drop according to the Release time and continue to follow the audio input signal level instead.

### Threshold

This defines at which input signal level the envelope follower should trig. Set to a low value, the envelope follower will react as soon as there is any audio signal present on the Pulveriser inputs. Set to a high value, the envelope follower will react only on loud input signals, or from a manual Trig signal.

The red lamp to the right of the Threshold knob gives a visual indication of the CV signal level.

- **On the back of Pulveriser you will find a Follower CV output - this delivers the CV signal from the envelope follower, allowing you to dynamically control parameters in other devices.**

### Attack

This controls how fast the envelope follower should react after the input signal has reached above the Threshold value. Note that the attack time can only be increased compared to the input signal - never shortened.

### Release

This controls how fast the envelope follower CV signal should drop to zero after the input signal has decreased below the Threshold value. Note that the release time can only be increased - never shortened.

### Modulation Amount knobs

To the left of the Follower section are two bipolar modulation amount knobs.

- **Turn the upper left knob to control the modulation of the Rate parameter of the Tremor section.**  
If the modulation knob is in the "+" sector the rate will increase according to increased audio level. If the modulation knob is in the "-" sector the rate will decrease according to increased audio level.  
If Sync is enabled in the Tremor section, the rate will jump between the different resolutions according to the Follower modulation amount.
- ! **Modulating the Tremor Rate in Sync mode can produce noise when the Rate parameter switches between resolutions. This noise can be eliminated by increasing the Lag amount in the Tremor section, see "Lag".**

- **Turn the lower left knob to control the modulation amount of the Frequency parameter of the Filter section.**  
If the modulation knob is in the “+” sector the Filter Frequency will raise according to increased audio level. If the modulation knob is in the “-” sector Filter Frequency will drop according to increased audio level.

## Blend



With the Blend knob you control the mix between the dry and wet signal. With the knob set somewhere in between the Dry and Wet position you will have parallel processing. This can be useful if you, for example, want to process a drum loop with compression (Squash) and distortion (Dirt) and mix the processed signal with the dry before sending it to the outputs.

## Volume



With the Volume knob you set the total output level of the dry+wet signals.

# Modulation inputs and outputs

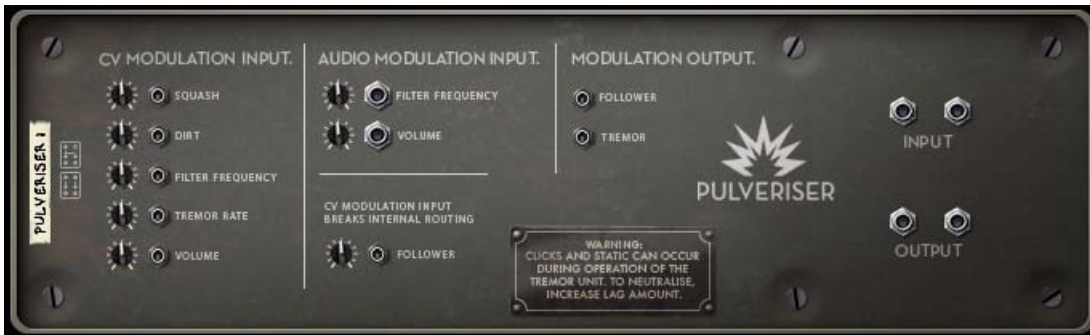

## CV Modulation inputs

On the back of Pulveriser you will find CV inputs for controlling the following parameters:

### Squash

Use this for dynamically changing the amount of compression in the Squash section.

### Dirt

Use this for dynamically changing the amount of distortion in the Dirt section.

### Filter Frequency

Use this for dynamically changing the Frequency parameter in the Filter section.

### Tremor Rate

Use this for dynamically changing the LFO Rate parameter in the Tremor section.

If the LFO is in Sync mode, the rate will jump between the different resolutions according to the CV modulation input signal amount.

### Volume

Use this for dynamically changing the output volume from Pulveriser.

### Follower

Use this for controlling the envelope follower signal from an external source. The internal envelope follower signal is replaced with the CV signal that is inserted here.

! **Note that the Attack and Release controls can still be used to shape the CV input signal.**

## Audio Modulation inputs

! **Note that these modulation inputs accept audio rate signals, which is really cool!**

## Filter Frequency

Use this for dynamically changing the Frequency parameter from an external audio signal. The result of this modulation is Filter FM.

## Volume

Use this for dynamically changing the output volume from an external audio signal. The result of this modulation is amplitude modulation (AM) of the Pulveriser output signal.

## CV Modulation outputs

### Follower

On this output the control signal from the Follower is present.

### Tremor

Here, the LFO CV signal from the Tremor section is present.

## Demolition tips and tricks

Don't restrict yourself to using Pulveriser as a basic compressor or distortion unit - you may be surprised to find how often Pulveriser can add power, warmth, color and "movement" to your sounds. Here are some examples:

## Beef up your sounds

Use Pulveriser to fatten up your sounds:

1. **Select the Low Pass 24 filter type in the Filter section.**
2. **Set the Frequency parameter to a low value so you can barely hear the lowest frequencies.**
3. **Set the Threshold, Attack and Release knobs in the Follower section to minimum values.**
4. **Slowly increase the Follower > Filter Amount knob until you can hear the lower frequencies of the sound.**
5. **Adjust the Blend knob until you are satisfied with the mix.**
6. **Adjust the Blend, Squash and Dirt knobs to fine-tune the sound.**

## Make your pads tremble

Use Pulveriser to create movements in your pad sounds:

1. **Select the Comb filter type in the Filter section.**
2. **Set the Peak knob in the Filter section to a fairly low value.**
3. **Turn the Tremor > Filter Modulation amount knob past the 12 o'clock position.**
4. **Set the Tremor Rate knob to around the 10 o'clock position.**
5. **Set the Threshold, Attack and Release knobs in the Follower section to minimum values.**
6. **Set the Follower > Tremor Amount knob to around the 2 o'clock position.**
7. **Set the Tremor > Volume knob to around the 3 o'clock position.**
8. **Play a pad sound which has long Attack, Decay and Release times and a fairly low Sustain value on its amp envelope.**

Notice how the Tremor Rate and intensity change and modulate the filter and volume according to the pad volume.

**Chapter 42**  
**Alligator**  
**Triple Filtered Gate**

# Introduction



The Alligator is a three-channel gate effect with a built-in pattern player. It can chop up audio in a wide variety of ways and process it with three parallel filters, distortions, a phaser and a delay. The Alligator can be used for processing sustaining sounds like strings and pads, adding rhythms and accents. It can also be used on loops and other rhythmic material, changing the feel and sound. Applied to a whole mix, the Alligator can be a powerful remix tool, totally reshaping the material.

## About the Patch format

Alligator patches have the file extension ".gator". The Factory Sound Bank contains a number of Alligator effect patches for use as is or as starting points for further tweaking. Patches are loaded and saved using the standard procedures.

- Don't forget that you can also save Alligator settings as part of a Combinator patch. Combining an instrument device with an Alligator is a quick way to create gated, rhythmic pads.

## Overview and signal flow

The Alligator may seem overwhelming at first - it's got quite a few knobs and buttons on its front panel. However, once you've understood the basic signal flow it's actually pretty straightforward. Read through the description below and get familiar with the basics - it will help you a lot when working with the Alligator.

Here is a simplified diagram of how the Alligator works:

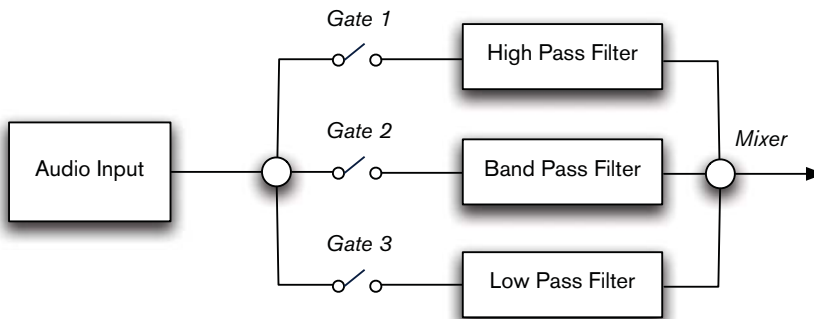



You normally connect the Alligator as an insert effect, so that all of the audio signal passes through the effect device. The incoming signal is split into three, parallel channels. For each channel, there is a separate gate - when that gate is open the signal passes through and when it's closed, the channel is silent. The gates can be opened in four ways:

- **By the built-in patterns.**  
There are 64 patterns, each with three "tracks" independently controlling the three gates.
- **By clicking the Manual Gate buttons on the front panel.**
- **By sending the MIDI notes F#1, G#1 and A#1 from a keyboard to the Alligator track in the sequencer.**  
This way you can play the Alligator live, with velocity control over the gate levels, see ["Playing the Alligator live"](#).
- **By connecting CV cables to the Gate inputs on the back of the Alligator and sending Gate signals, e.g. from a Matrix or Redrum.**

When a gate is open, the signal passes through a filter. The three channels have different types of filters: High Pass, Band Pass and Low Pass, respectively. This means the channels will have different sound characteristics.

Finally, the three channels are mixed together again and sent to the main output.

That's the signal flow in its most basic form. Looking at the front panel, you can see the signal split and the three channels with their gates and filters:



However, as you can see, there are quite a few other settings as well. Let's take a closer look at one of the channels (the band pass filter, in this example):

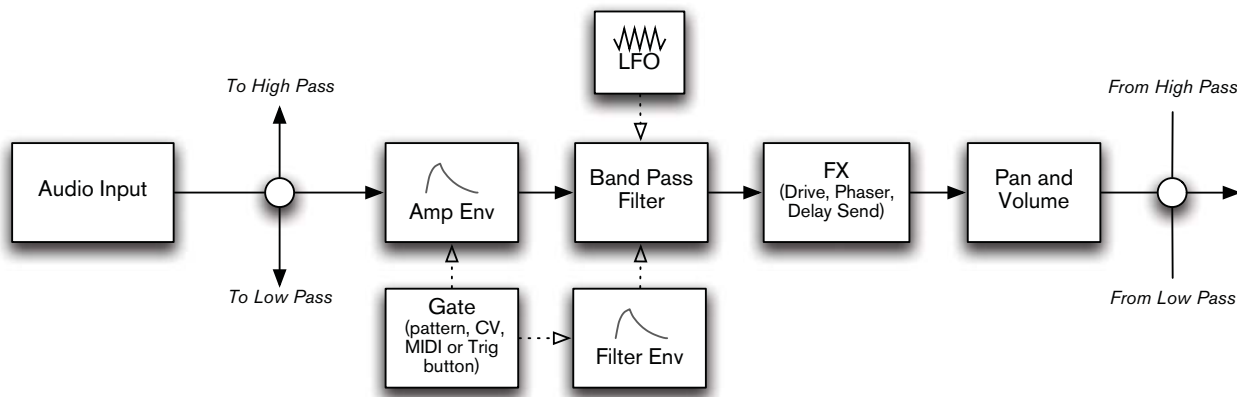

In this, more detailed diagram, we see that the gate isn't a simple on/off switch - there is actually an amplitude envelope controlling the volume of the channel. When the gate is opened, the envelope is triggered and the sound is let through according to the envelope settings. You can use the amp envelope to soften the attack, to make the notes shorter and more snappy, etc. The gate also triggers a filter envelope, so that each note can get an articulated filter contour. The filter can also be modulated by a global LFO.

Next in the channel are FX settings: a distortion unit, a swirling phaser and a send to a built-in delay unit. Since these settings are independent for the three channels, they can give you a lot of variations.

Finally, there are Pan and Volume controls. Even a function as basic as stereo panning can make for really interesting, spatial effects - especially since you can pan the three channels, the dry signal and the delay independently!

# Parameters

## Common effect device parameters

Like all effect devices, Alligator features a Bypass/On/Off switch and an input level meter. These are described in [“Common effect device features”](#).

## Pattern section



### Pattern On

When this is on, the built-in pattern player will run in sync with the song tempo, controlling the three gates. Turn it off if you want to control the gates manually or with MIDI/CV.

### Shuffle

Shuffle on the Alligator works in the same way as shuffle on the Redrum and Matrix devices. It will delay every second 1/16th note in the playing pattern according to the Global Shuffle Amount setting in the ReGroove mixer, creating a shuffle or swing feel.

Note that Shuffle will work best when Resolution is set to 1/16.

### Pattern selector

This is where you select which one of the 64 built-in patterns should play back, controlling the gates. There is a guide to the patterns in [“The built-in patterns”](#).

### Resolution

When this is set to 1/16 (default) the built-in patterns will be based on 1/16th notes. Changing the Resolution setting allows you to scale the patterns, making them play back faster or slower in relation to the song tempo.

### Shift

This will offset the pattern relative to the song playback, moving it “sideways”. The range is  $\pm 16$  steps, with the step length determined by the Resolution parameter. For example, if you set Shift to -1 with Resolution at 1/16, the pattern will be moved one sixteenth note to the left. This means the pattern will play one sixteenth note “early” (the start of the pattern will occur a sixteenth note before the downbeat in the song).

# Gate and Amp Envelope

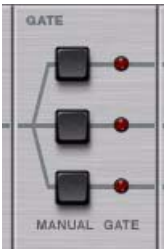

## Manual Gate Trig buttons

Clicking one of the Manual Trig buttons will open the corresponding gate. It will remain open for as long as you keep the mouse button pressed. However, the sound may fade out slowly or quickly depending on the amplitude envelope settings.

While the gate is held open manually, it won't be affected by the built-in pattern. This means you can use the buttons to override the pattern, holding a channel open (if Amp Env Decay is long) or muting it (if Amp Env Decay is short).

## Gate indicators

These light up when the gates are open.

## Amp Env Attack



When a gate is opened, the Amplitude Envelope is triggered. This controls the input level to the corresponding filter. Amp Env Attack sets how long it takes for the level to reach its maximum after the gate opens. Normally, this is kept at a low value for quick, snappy attacks. Raising the Attack parameter will make the notes fade in, blurring the patterns.

## Amp Env Decay



Directly after the attack phase, the input level will fade down to zero again. The time this takes is set with the Amp Env Decay parameter. Setting the Decay knob to its maximum value will set the decay time to infinity, which will result in a maximum "sustain" level. Lowering the Decay setting will make the pattern notes shorter.

## Amp Env Release



This determines how quickly the sound fades out after the gate is closed. If you raise this setting, the sound will never fade out completely between gates, and the pattern will become blurred and more pad-like.

# Filters and Modulation



The three channels have identical settings, even though their filters are of different types. Below, all descriptions apply to all three channels, if not explicitly stated.

## Filter On button

When this is on, the channel's signal passes through the filter. Turning this off bypasses the filter. Note though that the Gate, Amp Envelope, effects and other settings are still active.

## LFO Amount

Determines how the filter frequency should be affected by the global LFO (see below). This is a bipolar control, allowing for positive or negative modulation of the filter frequency.

## Frequency

- For a general introduction to different filter types, see **“The Filter Section”** in the **Subtractor** chapter.
- **For the high pass filter, this is the cutoff frequency.**  
Frequencies below this will be removed from the signal. Turning this parameter up will gradually remove more and more of the signal, leaving only the highest frequencies.
- **For the band pass filter, this is the center frequency.**  
Lower and higher frequencies will be removed from the signal.
- **For the low pass filter, this is the cutoff frequency.**  
Frequencies above this will be removed from the signal. Turning this parameter down will gradually remove more and more of the signal, leaving only the lowest bass frequencies.

## Resonance

The filter resonance emphasizes the frequencies around the set filter frequency. Turning this up will make the filter sound more pronounced and ringing.

## Envelope Amount

This determines how the filter frequency is affected by the Filter Envelope (see below). This is a bipolar control, allowing for positive or negative modulation of the filter frequency.

## LFO Waveform



The global LFO offers nine different waveforms, ranging from sine, triangle and square to random and various stepped forms.

## LFO Frequency



Sets the rate of the LFO, used for continuous modulation of the filters. If LFO Sync is activated, the LFO Frequency is expressed as a note value relative to the song tempo; if not, the LFO Frequency is free.

## LFO Sync



Turn this on to synchronize the LFO to the song tempo.

## Filter Env Attack



Like the amplitude envelope, the filter envelope is triggered by the gates. There are in fact three individual envelopes, one for each filter, but they share the same controls. For the filter envelopes to have any effect on the sound, you need to set the Env Amount parameters to negative or positive values for one or more filter channels.

The Filter Env Attack determines how quickly the filter envelope rises to its maximum value when the gate is opened.

## Filter Env Decay



Directly after the attack phase, the filter envelope signal will fall to zero again. The time this takes is set with the Filter Env Decay parameter.

## Filter Env Release



This determines how quickly the filter envelope signal falls to zero after the gate is closed. To fully hear the effect of this parameter, you need to raise the Amp Env Release parameter - otherwise the level will drop to zero directly when the gate closes and you won't hear any filter changes.

## Effects



The three channels have identical effect parameters. Distortion and phaser effects are separate for the three channels (although the phasers have common controls). The delay is a global effect, working much like a send effect in a mixer.

### Drive Amount



Sets the amount of distortion for the channel.

### Phaser Amount



Sets the amount of phaser effect for the channel.

### Delay Amount



This works like an effect send, determining how much of the signal should be sent to the built-in delay effect. The send is post-volume: If you lower the volume for a channel, the signal sent to the delay will be lowered as well.

### Delay Time



This is a standard delay unit with a maximum delay time of  $2/4$  (when synced to the song tempo) or 1 second.

## Delay Sync



Turn this on to set the delay time in musical values relative to the song tempo.

## Delay Feedback



This determines the number of delay repeats.

## Delay Pan



Sets the stereo panning of the delay repeats.

## Phaser Rate



The rate of the phaser sweep.

## Phaser Feedback



This is similar to the resonance control on a filter. Raise the feedback to get a more pronounced, "singing" phaser effect.

## Mix controls



These parameters determine the signal mix being sent to the main outputs on the back. There are also individual outputs for the three gate/filter channels. If you connect these outputs, the corresponding channel signals will be removed from the main mix, leaving only the delay return signal and the dry signal.

### Channel Pan



Sets the stereo pan/balance of the channel.

### Channel Volume



The volume of the channel.

### Dry Ducking



The Ducking parameter will apply the Amp Envelope to the dry signal - but inverted. This means that whenever the Amp Envelope is “high”, the dry signal will be lowered in volume or “ducked”. The result is a sort of mirror to the sound from the three gated channels.

**! Note that this is only audible if the Dry Volume has been raised.**

### Dry Pan



Sets the stereo pan/balance of the dry, unprocessed signal.



## Dry Volume



Sets the volume of the dry, unprocessed signal. Mixing in a bit of the dry sound is useful for subtler processing, e.g. when you just want to animate a pad rather than chop it up.

## Master Volume



This is the master volume of the mixed signals. The signals from the separate channel outputs on the back won't be affected by this.

## Audio connections



## Main Inputs and Outputs

The Alligator is normally connected as a stereo in-stereo out effect. Should you connect a mono input signal, the output will still be in stereo due to the pan controls.

## Separate Outputs

These output the signals from the individual gate/filter channels. Connecting one of these outputs will remove the corresponding channel signal from the main output. The separate output signals are taken after the Channel Volume controls but are unaffected by the Master Volume.

# CV connections

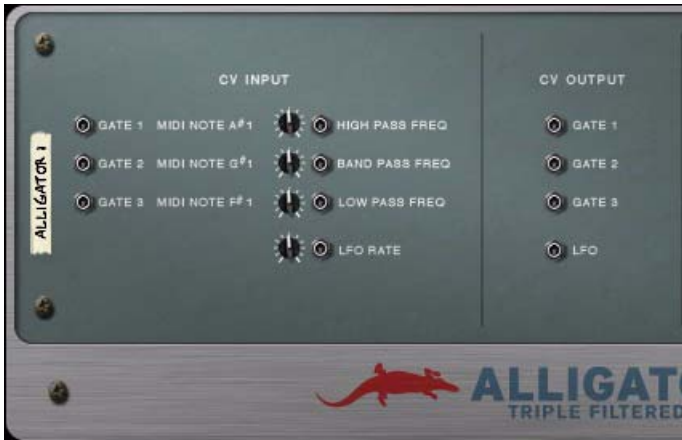

## Gate inputs

These are used for controlling the gates from other devices, using CV. When a gate input receives a CV value of 7 or higher, the gate will be opened. Higher values result in higher input level for the gate channel (i.e. the gates are velocity sensitive).

- **If you select an Alligator device and create a Matrix Pattern Sequencer, its gate output will be auto-routed to the first available Gate input. Also, the Matrix Curve CV output will be auto-routed to the corresponding CV Freq input on the Alligator.**

You can create up to three Matrix Pattern Sequencers with the Alligator selected and the Matrix devices will be auto-routed to separate Gate and CV Freq inputs on the Alligator.

- ! **Note: If you want the gates to be controlled by CV only, you need to turn off the Pattern player on the front panel. Otherwise, the gate sources will be combined.**

## CV Modulation inputs

These jacks allow you to modulate the filter frequencies of the three filters, as well as the global LFO rate.

## Gate Outputs

The three Gate outputs simply send out the current Gate values, regardless of whether these are controlled by the built-in pattern player, the buttons on the front panel, MIDI or CV. You can use these to trigger other sounds and effects in time with the gates.

## LFO CV Out

This is the output of the built-in LFO, for modulating parameters in other devices.

# The built-in patterns

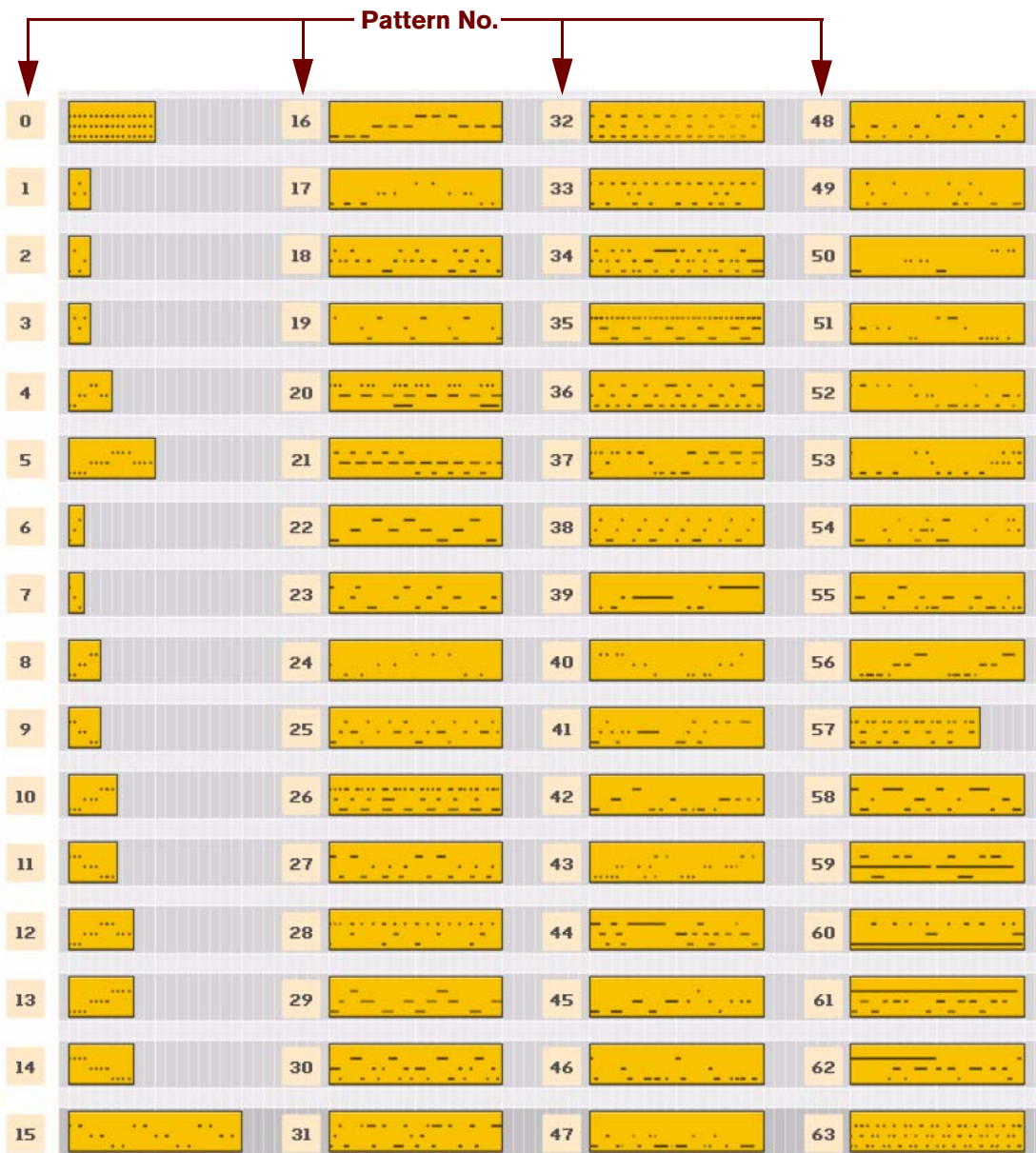

This is an overview of the 64 built-in patterns. The black dots signify open gates with gate 1 (high pass filter) at the top. Most patterns are two bars long, but some are shorter. All patterns will repeat continuously when the Pattern function is on.

# Methods and Tips

## Playing the Alligator live

The three gates in the Alligator can be triggered by the MIDI notes F#1, G#1 and A#1, with the lowest note controlling the low pass filter channel and so on. This can be very useful when playing live:

- 1. Create and connect an Alligator as an insert effect for the audio material you want to process.**  
This could be a recorded pad, a loop or even the full mix.
  - 2. Make sure the Alligator is selected and select “Create Track for Alligator” from the Edit menu.**  
This creates a track with a note lane for the Alligator.
- If you like, turn off the Pattern section on the Alligator.
- 3. Start playback and use the keys F#1, G#1 and A#1 to play the gates.**  
Remember that the gates are velocity sensitive and that the Amp Envelope settings affect the gated sound.

## Playing the gates from Matrix patterns

While the 64 built-in patterns are rather versatile, sometimes you might want to create your very own patterns. The easiest way to achieve this is to connect Matrix Pattern Sequencers:

- 1. Select the Alligator device.**
  - 2. Create a Matrix from the Create menu or Device palette.**  
It is automatically connected to one of the Gate inputs on the backside. The Curve CV output on the Matrix is automatically connected to the corresponding CV Freq input on the Alligator.
  - 3. Repeat these two steps twice, to create two more Matrix devices.**  
Note that you need to select the Alligator for the Matrix to be auto-routed to the Gate and CV Freq inputs. Now you have three Matrix devices, one for each gate/channel.
  - 4. Turn off the Pattern player in the Alligator.**
  - 5. Use the Gate section in the Matrix display to program custom gate patterns.**  
The Curve can be used for controlling the Filter Frequency of the corresponding frequency band in the Alligator.
- Another interesting trick is to load a rhythmic loop into a Dr Octo Rex device and connect its Slice Gate Output to a Gate input on an Alligator. This makes the slices in the REX loop trigger the gate.

## Controlling other sounds and effects

The gate outputs on the Alligator back panel allow you to control other stuff with the built-in Alligator patterns. Here's an example:

- 1. Create an instrument with a sustaining sound, such as a pad.**
  - 2. Turn on loop mode in the main sequencer and record some chords.**
  - 3. Create an Alligator and select a suitable pattern.**  
You might want to tweak the sound as well, change the filter settings, adjust fx and pan, etc.
- With some tweaking, the filtered pattern can sound a bit like a drum beat or percussion loop. Then it can be nice to add some punch and bottom to the Low Pass channel, making it feel more like a kick drum or bass line:
- 4. Create a Kong Drum Designer.**
  - 5. Load a punchy bass drum sound into Pad 1.**
  - 6. Flip the rack around and route a CV cable from Gate 3 Out on the Alligator to the Gate input for Kong's pad 1.**  
Now the bass drum sound is triggered along with Gate 3, played by the Alligator's pattern player.

**7. Adjust the Kong level to taste.**

**8. If you like, add other sounds for Gate 1 and 2 in the same way.**



**Chapter 43**  
**RV7000 Mk II**  
**Advanced Reverb**

# Overview



The RV7000 Mk II is a high quality reverb processor. It features ten different reverb and echo algorithms, ranging from rooms and halls to special effects. The Mk II version also incorporates a high-quality zero-latency convolution algorithm, which makes it possible to load sampled impulse responses - and even sample and use your own impulse responses!

Since the RV7000 Mk II comes with a number of useful reverb presets, you could simply select one and tweak the most important parameters on the main panel - or you could use the Remote Programmer panel to fine-tune the reverb in great detail.

The RV7000 Mk II also contains an equalizer and a gate section. Both of these are for processing the actual reverb sound, making it possible to get virtually any kind of reverb character, including gated reverb.

## About the Patch format

The RV7000 Mk II features programmable effect presets. In the Factory Sound Bank you will find a number of preset Patches which can be used as they are or provide you with a good starting point for further tweaking.

Patches use the Windows file extension "\*.RV7". Loading and saving Patches is done in the same way as for instrument devices.

**! Songs and/or Patches that use Convolution (or have an Impulse Response sample loaded) can not be opened in older Reason versions. The same goes for Combi Effect patches that contain RV7000 Mk II in Convolution mode (or with a sample loaded, or with the Combi programmer referencing Convolution parameters).**

**! Convolution patches that use samples only contain references to the samples - not the sample itself. This is the way all sampler devices in Reason work.**

## Connections

Typically you connect the RV7000 Mk II as a send effect, as this allows you to use it for processing several different mixer channels. However, it's also possible to use it as an insert effect - use the Dry/Wet control on the main panel to adjust the balance between the dry, unprocessed sound and the reverb. Note:

→ **The RV7000 Mk II is a true stereo reverb (except in Convolution mode), which means that it will use the stereo input information when processing both channels (without summing the input channels).**

It's also possible to use it as a mono in - stereo out effect. Which type of connection to use (mono or stereo in) depends on the material. If the audio sources are in mono (or in stereo but with no important difference between the left and right channel) using a mono input is sufficient.

→ **If you want to use RV7000 Mk II's Reverse reverb effect, you should consider connecting it as an insert effect or using a Send on the Mixer, with Pre-fader mode selected (and the channel fader lowered).**

This is because you typically don't want to hear the dry sound when using the Reverse effect. See ["The Gate section"](#).



## The main panel



The RV7000 Mk II main panel.

When you create an RV7000 Mk II, only the main panel will be shown. This contains a section for handling patches, on/off buttons for the EQ and Gate sections, the most important reverb parameters and a dry/wet mix control. To select a reverb patch and make coarse adjustments, this is all you need.

## The Remote Programmer

Clicking the arrow button next to the “cable slot” on the main panel brings up the remote programmer panel.



This is where you make detailed settings for the reverb. Note:

- **The Edit Mode button to the left determines which section to make settings for, Reverb, EQ or Gate.**
- **Settings are made with the eight dials around the graphic display. The functions of the dials differ depending on the selected Edit Mode and the selected reverb algorithm. Next to each dial, the display shows the name and value of the corresponding parameter.**

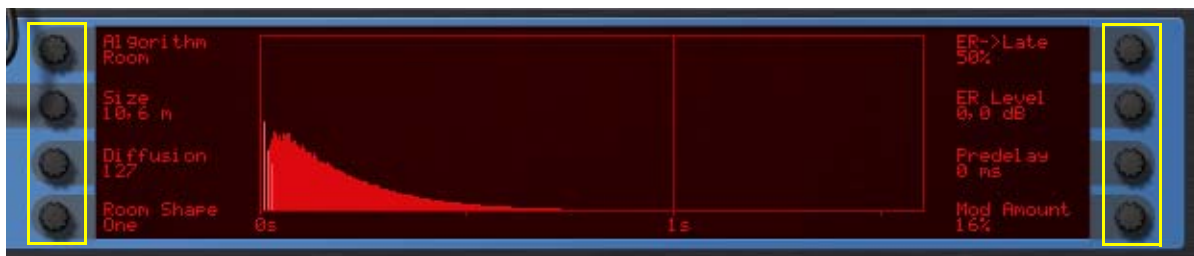

- **Not all modes and algorithms use all eight dials. If a dial isn't used in the selected mode, nothing will be shown next to it in the display.**
- **You cannot make settings in the graphic display itself - this is for showing a graphic representation of the selected reverb.**

# Reverb algorithms and parameters

## Common effect device parameters

While the specific parameters for the RV7000 Mk II effect device are described below, some features and procedures are common to all effect devices. Please, refer to “[Common effect device features](#)” for information about the Input meter, the Bypass/On/Off switch and Signal Flow Graphs on the effect device.

## About the main panel parameters



On the main panel you find three parameters that are available for all algorithms:

Parameter	Description
Decay	This governs the length of the reverb or the feedback if an echo algorithm is selected.
HF Damp	Controls how quickly the high frequencies should decay in the reverb. Raise it to gradually remove high frequencies, making the reverb sound warmer and less bright.
HI EQ	This is a high-shelving EQ that works much like a typical treble control on a mixer or amplifier. Lower the setting for a softer reverb sound or raise it to get more high frequencies.

## Selecting an algorithm

You select a reverb algorithm in the remote programmer panel:

1. Click the remote programmer arrow button on the main panel to display the remote programmer panel.
2. Make sure the Edit Mode button is set to Reverb.
3. Use the top left dial to select a reverb algorithm.

The selected algorithm is shown in the display next to the dial.

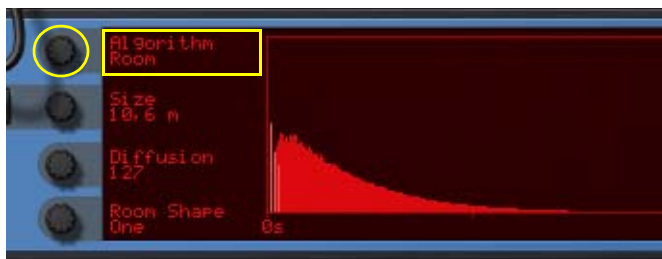

Here's a quick overview of the ten algorithms - for details and parameter descriptions, see below.

Algorithm	Description
Small Space	Emulates a small enclosed space (a small room or a resonant body).
Room	Emulates a room with adjustable shape and wall character.
Hall	Emulates a hall.
Arena	Emulates a large arena, with separate pre-delay for the left, right and center reverbs.
Plate	Emulates a classic plate reverb.
Spring	Emulates a spring reverb, as used in e.g. guitar amplifiers.
Echo	An echo effect with gradually diffusing echo repeats. Can be synced to Reason's tempo.
Multi Tap	A multi-tap delay with four different delay lines and tempo sync.
Reverse	A reverse reverb that "pushes" the dry sound to appear after the reverb. The result is a backwards reverb leading up to the direct sound.
Convolution	The zero-latency Convolution algorithm uses impulse response samples. The samples are used for generating the desired reverb effect (or actually any type of effect - depending on what sample you use).

## Small Space

This algorithm places the sound in a small enclosed space, ranging from a tiny resonant body to a room. The parameters are:

Parameter	Description
Size	The size of the emulated space.
Mod Rate	The reverb can be randomly modulated for a more even sound (or for special effects). This parameter sets the rate of modulation (the amount is set with Mod Amount).
Room Shape	Select from four different room shapes, affecting the character of the reverb.
LF Damp	Controls how quickly the low frequencies should decay in the reverb. Raise it to gradually remove low frequencies, making the reverb sound "thinner" and less boomy.
Wall Irreg	Adjusts the positioning of the emulated walls in the small space. The lowest setting emulates two directly opposed walls while higher settings emulate more walls and angles, for a more complex resonance.
Predelay	Sets the predelay time, i.e. the delay between the source signal and the start of the reverb.
Mod Amount	Sets how much the reverb will be modulated. Use fairly low settings when emulating real rooms and resonant bodies, and higher settings for special effects.

## Room

Emulates a medium-sized room, with the following parameters:

Parameter	Description
Size	The size of the emulated room.
Diffusion	At low Diffusion settings, you will hear the individual reverb "bounces" more clearly, while higher settings produce a more "smeared", dense and even reverb.
Room Shape	Select from four different room shapes, affecting the character of the reverb.
ER->Late	The first "answers" in the reverb are called early reflections (ER) and are typically more pronounced than the actual reverb tail. This parameter sets the time between the early reflections and the reverb tail. This is set as a percentage - the actual delay time depends on the Size setting.
ER Level	Adjusts the level of the early reflections. "0" is normal level.
Predelay	Sets the predelay time, i.e. the delay between the source signal and the start of the early reflections and reverb.
Mod Amount	Sets how much the reverb will be modulated. Moderate modulation gives a natural, less static sound.

## Hall

Emulates a hall. The parameters are the same as for the Room algorithm above (but the Hall algorithm offers larger Size settings).

## Arena

Emulates the ambience in an arena or concert hall, with long pre-delay times (separate for left, right and center):

Parameter	Description
Size	The size of the emulated arena or hall.
Diffusion	At low Diffusion settings, you will hear the individual reverb "bounces" more clearly, while higher settings produce a more "smeared", dense and even reverb.
Left Delay	The predelay time for the left side of the reverb.
Right Delay	The predelay time for the right side of the reverb.
Stereo Level	Adjusts the level of the left and right sides of the reverb. "0" is normal level.
Mono Delay	The predelay time for the mono (center) reverb signal.
Mono Level	Adjusts the level of the mono (center) reverb signal. "0" is normal level.

## Plate

A classic plate reverb, excellent for vocals for example. The parameters are:

Parameter	Description
LF Damp	Controls how quickly the low frequencies should decay in the reverb. Raise it to gradually remove low frequencies, making the reverb sound "thinner" and less boomy.
Predelay	Sets the predelay time, i.e. the delay between the source signal and the start of the reverb.

## Spring

An emulation of a spring reverb as can be found in guitar amplifiers, organs, etc. The spring reverb has the following parameters:

Parameter	Description
Length	Sets the length of the simulated spring.
Diffusion	At low Diffusion settings, you will hear the individual reverb "bounces" more clearly, while higher settings produce a more "smeared", dense and even reverb.
Disp Freq	When sending a signal to a real-life spring reverb, the initial transient will produce a quick, characteristic sweeping tonal noise. This is because different frequencies in the sound are delayed by different amounts (a phenomenon called dispersion). This parameter controls the frequency of that sound.
LF Damp	Controls how quickly the low frequencies should decay in the reverb. Raise it to gradually remove low frequencies, making the reverb sound "thinner" and less boomy.
Stereo (on/off)	Determines whether the output of the spring reverb should be in mono or stereo.
Predelay	Sets the predelay time, i.e. the delay between the source signal and the start of the early reflections and reverb.
Disp Amount	Sets the amount of dispersion effect (see Disp Freq above).

# Echo

This is an advanced echo effect, with diffusion controls and tempo sync. When Echo is selected, the Decay control on the main panel controls the echo feedback (the number of echo repeats). The parameters are:

Parameter	Description
Echo Time	Sets the time between each echo. When Tempo Sync (see below) is off, the echo time is set in milliseconds (10 - 2000 ms); when Tempo Sync is on you set the echo time as a number of 1/16 notes or 1/8 triplet notes, in relation to the current song tempo.
Diffusion	When this is set to 0, the echo will sound as a standard delay with clear, precise repeats. Raising the Diffusion setting will introduce additional echoes very close to the "main" echo repeats, causing a "smeared" echo sound. This will also expand the echo stereo image.
Tempo Sync	Determines whether the echo time should be freely set ("off") or synchronized to Reason's tempo ("on").
LF Damp	Controls how quickly the low frequencies should decay in the echoes. Raise it to gradually remove low frequencies.
Spread	Adjusts the spacing of the additional echoes added by the Diffusion parameter. For a very smeared echo (sound more like a reverb), set both Diffusion and Spread to their maximum values.
Predelay	Sets an additional delay time before the first echo repeat.

# Multi Tap

The Multi Tap delay produces up to four different delays with separate delay times, panning and level. The whole set of four delay taps can then be repeated at a given rate. Again, the Decay control on the main panel controls the feedback (the number of repeats for the whole multi tap set). All delay times can be tempo synced.

Note: this algorithm is handled a bit differently since you make separate settings for each delay tap:

- **The parameters to the left of the display are common for all taps.**
- **You use the Edit Select parameter in the top right corner to select which tap to make settings for - the three parameters below affect the currently selected tap.**

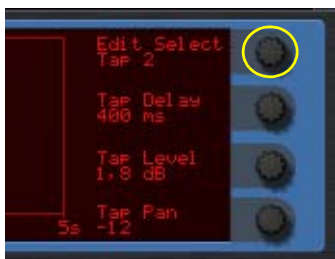

*Tap 2 selected for editing.*

- **You can also set Edit Select to "Repeat Tap" - this is where you specify the repeat time for the whole multi tap "package".**  
With short Repeat times, the first tap may be repeated before the last tap has sounded. This can be used to create very complex multiple delay effects.

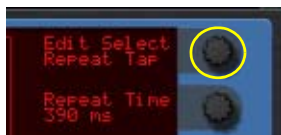

The common parameters (to the left) are:

Parameter	Description
Tempo Sync	Determines whether the delay times and repeat times should be freely set ("off") or synchronized to Reason's tempo ("on").

Parameter	Description
Diffusion	Raising the Diffusion setting will introduce additional echoes very close to the “main” repeats, causing a “smeared” delay sound.
LF Damp	Controls how quickly the low frequencies should decay in the echoes. Raise it to gradually remove low frequencies.

When Tap 1 - 4 is selected with the Edit Select parameter, you can make the following settings for the selected delay tap:

Parameter	Description
Tap delay	Sets the delay - the time from the source signal to the tap. When Tempo Sync is off, the delay time is set in milliseconds (10 - 2000 ms); when Tempo Sync is on you set the delay as a number of 1/16 notes or 1/8 triplet notes, in relation to the current song tempo.
Tap level	Adjusts the level of the selected tap.
Tap pan	Adjusts the pan of the selected tap.

When Repeat Tap is selected with the Edit Select parameter, there is only one parameter to the right in the display:

Parameter	Description
Repeat Time	Sets the time between each repeat of the whole multi tap set. The number of repeats is set with the Decay control on the main panel. When Tempo Sync is off, the repeat time is set in milliseconds (10 - 2000 ms); when Tempo Sync is on you set the repeat time as a number of 1/16 notes or 1/8 triplet notes, in relation to the current song tempo.

## Reverse

The Reverse reverb algorithm in RV7000 Mk II is special in that it actually “moves” the source audio as well. Sounds fed into the Reverse reverb are “sampled”, a reverse reverb is created and played back and finally the “sampled” original sound is played back. For example, if you feed a snare drum hit into the Reverse reverb, you will hear a rising “backwards” reverb, followed by the snare drum hit.

Therefore, you probably don't want to hear the first, original (dry) sound. There are two ways to set this up:

- **Connect the RV7000 Mk II as an insert effect and make sure the Dry/Wet control on the main panel is set fully to “Wet”.**
- **Connect the RV7000 Mk II as a send effect using one of the Sends on the Mixer, activate the Prefader (PRE) switch for the send and lower the mixer fader completely for the source signal.**  
That way, the signal will be sent to the reverb but the dry sound from the Mixer channel isn't heard. Again, the Dry/Wet control should be set to “Wet”.

Note that with this algorithm, raising the Decay setting on the main panel will make the reverse reverb start earlier and build up under a longer time. Similarly, the HF Damp parameter affects how fast the high frequencies are built up in the reverse reverb. In the remote panel, the Reverse algorithm has the following parameters:

Parameter	Description
Length	This sets the time from when the source signal is fed into the reverb until it is played back again. It is during this time you will hear the reverse reverb, as shown in the display. The time can be set in milliseconds or as note values, depending on whether Tempo Sync is off or on. Note: As stated above, the Decay setting determines the length of the actual reverse reverb - in essence how soon it starts after the source signal. But of course, the reverse reverb cannot start <i>before</i> the original source signal! If you set Decay to a longer time than the Length setting, the reverse reverb will start abruptly, immediately when the source signal is fed into the reverb. If this sounds complicated, just take a look at the RV7000 Mk II display and try the settings - you will soon see how it works. Note also that very high Length settings demand a lot of processor power. This can be reduced by adjusting the Density parameter, see below.

Parameter	Description
Density	Density governs the “thickness” of the Reverse effect. If this parameter is turned down to zero, the effect produces individual delays rather than a dense “wash”, which can be used as a special effect. Worth noting is that if Density is set to around 50%, this can considerably reduce the CPU load without altering the sound of the effect too much. Exactly how much the Density parameter can be reduced without altering the sound depends on the source material.
Rev Dry/Wet	Sets the balance between the “moved” source signal (“dry”, low values) and the reverse reverb (“wet”, high values).
Tempo Sync	Determines whether the Length setting should be freely set (“off”) or synchronized to Reason’s tempo (“on”).

## Convolution

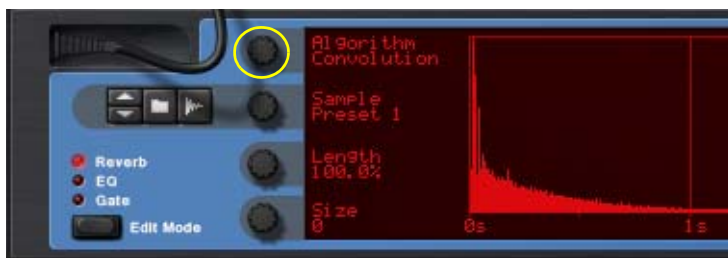

The zero-latency Convolution algorithm uses impulse response samples to generate effects. Basically, “convolution effects” are the results of multiplying the frequency spectra of the input signals with the frequency spectra of impulse response samples, and thus generating a signal with the “character” of the impulse response sample. If the impulse response sample is a recording of the reflections of a large room, for example, the resulting effect will be “the input audio signal played back in a large room”.

RV7000 Mk II comes with three built-in preset impulse response samples. You can also use any other samples for the convolution algorithm, to generate all kinds of reverbs and special effects. You can even sample your own impulse responses and use in the convolution algorithm in RV7000 Mk II.

- Propellerhead have gathered a large number of impulse responses and collected them in a free ReFill, along with lots of patches for the RV7000 Mk II and the Combinator. The ReFill is called "RV7000 mkII patches" - download it for free from [shop.propellerheads.se](http://shop.propellerheads.se)!

Note that in the Convolution algorithm the input signals for the effect are first summed to mono (except in Parallel Stereo Mode (see “Stereo Mode”)) and then processed with the impulse response sample. The figures below shows the signal routings in the Convolution algorithm:

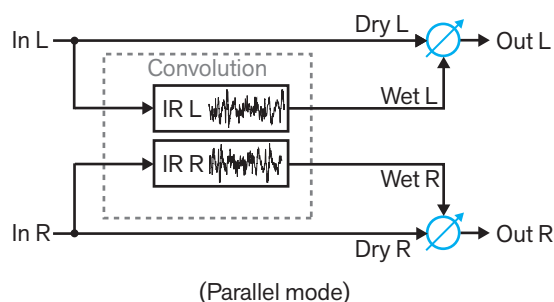
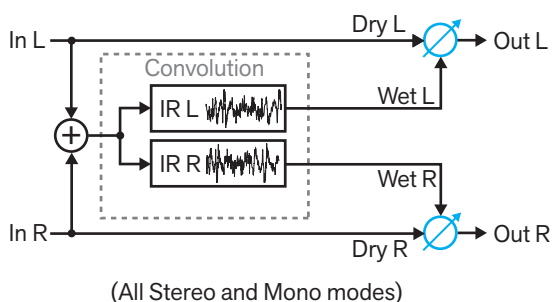

In the remote panel, the Convolution algorithm has the following parameters:

Parameter	Description
Sample Preset	Here you select one of the preset impulse response samples - plus your own sample (if you use that, see “Loading impulse response samples”).
Length	Sets the length (end point) of the currently used impulse response sample.

Parameter	Description
Size	Simulates the "size" of the impulse response sample, in practice its pitch, in semitone steps. -12 means pitching up the impulse response sample 1 octave and 12 means pitching it down 1 octave.
LF Damp	Controls how quickly the low frequencies should decay. Raise it to gradually remove low frequencies, making the effect sound "thinner" and less boomy.
Stereo Mode	Determines how the output signal should be presented. Note that the stereo effect is derived from the impulse response sample itself. So, the wider the stereo effect in the impulse response sample, the wider the stereo effect in the output.  Note that if you use a mono impulse response sample, all effects below will be in mono!  Stereo: The input signals are summed and then a stereo effect with a spread of 100% is applied. Stereo75%: The input signals are summed and then a stereo effect with a spread of 75% is applied. Stereo50%: The input signals are summed and then a stereo effect with a spread of 50% is applied. Stereo25%: The input signals are summed and then a stereo effect with a spread of 25% is applied. Mono: The input signals are summed and then the effect is panned to a centered mono signal (0% spread). M->S Slow: From Mono slowly panned out to full Stereo. M->S Fast: From Mono quickly panned out to full Stereo. S->M Slow: From full Stereo slowly narrowed down to Mono. S->M Fast: From full Stereo quickly narrowed down to Mono. Parallel: Individual processing of the two L and R stereo input signals (dual mono).
Predelay	Sets the predelay time, i.e. the delay between the source signal and the start of the convolution effect. A negative predelay masks the start of the sample, so if the sample has unwanted initial transients or silence, these can be "re-moved".
Gain	Sets the amplification or attenuation of the effect signal.

Below are some things to keep in mind when you are working with the Convolution algorithm:

- **If you want the impulse response sample to play back exactly like the original, make sure the Decay knob is at max, the LF Damp knob at zero and the Hi EQ knob at its 12 o'clock position. Also, make sure the Length parameter is at 100% and the Size parameter at 0.**
- **The Length value of the impulse response sample is also affected by the Decay knob setting.**  
If the impulse response sample is quiet at the end, reduce the Length value to cut it off a little earlier. The Decay parameter introduces a smoother "cutoff" at the end, which might be desirable in many situations.
- **Changing some convolution parameters re-calculates the impulse response in real time. Therefore, modulating these parameters might give unexpected results. Specifically:**

**Using CV to modulate the RV7000 Mk II in Convolution mode is not recommended.**

**If you're using the Gate function (see "The Gate section") in combination with Convolution, we recommend setting the Decay Mod parameter to 0 (see "Decay Mod").**

## Loading impulse response samples

Besides the preset impulse response samples, you can load any other samples into the RV7000 Mk II and use as impulse responses. Loading a sample automatically switches the Algorithm to Convolution.

→ **Drag and drop a sample onto the RV7000 Mk II panel to automatically load it in the Convolution Algorithm.**

Or, do as follows:

1. **Click the Browse Samples button on the Programmer panel to set browse focus to the RV7000 Mk II.**





## 2. Select the desired sample in the Browser and load it.



Here we have selected and loaded the “Fx\_DubHead.WAV” sample to use as impulse response. You can see that the sample name is now displayed to the right of the Preset knob.

- ! **Note that the maximum length of a sample used as an impulse response is approximately 12 seconds. Longer samples are automatically truncated to 12 seconds (non-destructive).**
- ! **Note that any embedded loop data in the samples are disregarded when loaded into the RV7000 Mk II!**
- ! **Note that the Programmer display only shows the first 4 seconds of longer samples.**

– To achieve stereo effects in the Stereo Mode alternatives (see **“Stereo Mode”**) you have to use stereo samples.

## 3. Edit the Convolution parameters on the RV7000 Mk II panel until you are satisfied.

- If you want to save your RV7000 Mk II patch with your impulse response sample, click the Save Patch button on the upper panel:



- ! **Note that the impulse response sample is NOT saved in the patch itself - only a reference to the sample! If you have loaded an external sample (that is not in the Factory Soundbank), you may want to save the patch with the sample in your song. See **“About Self-Contained Songs”**.**

## Sampling your own impulse response samples

You can also sample your own impulse response samples and use with the Convolution algorithm. The sampling procedure is the same as for any other sampler device in Reason:

- Click the **“Start sampling”** button on the Programmer panel to record your own sample:



- ! **Note that the maximum length of a sample used as an impulse response is approximately 12 seconds. Longer samples are automatically truncated to 12 seconds (non-destructive).**
- ! **Note that any embedded loop data in the samples are disregarded in the RV7000 Mk II!**
- ! **Note that the Programmer display only shows the first 4 seconds of longer samples.**

– To achieve stereo effects in the Stereo Mode alternatives (see **“Stereo Mode”**) you have to sample in stereo.

Please refer to the **“Sampling”** chapter for details on how to set up and sample in Reason.

# The EQ section



The equalizer in RV7000 Mk II affects the wet reverb sound only and is used for shaping the character of the reverb. There are two EQ bands, one for low frequencies (shelving) and one full-range parametric EQ.

- **To activate the EQ, click the EQ Enable button on the main panel so that the indicator lights up.**
- **To make EQ settings, select “EQ” with the Edit Mode button to the left in the remote programmer panel.**
- **In this mode, the remote programmer display shows a frequency curve, indicating the settings you make with the EQ parameters.**

The parameters are:

Parameter	Description
Low Gain	The amount of cut or boost of the low-shelving filter.
Low Freq	The frequency below which the Low Gain cut or boost is applied.
Param Gain	The amount of cut or boost for the parametric EQ.
Param Freq	The center frequency of the parametric EQ, e.g. at which frequency the level should be decreased or increased.
Param Q	This governs the width of the affected area around the set center frequency. The higher the value, the narrower the affected frequency range.

- **Remember that you have a third EQ band at your disposal - the HI EQ parameter on the main panel.**  
The reason why this is on the main panel and not in the EQ section is simply that it's a setting you may want to adjust often, without having to open the remote programmer panel.

# The Gate section



The Gate section allows you to create gated reverb effects with a lot of options and possibilities. You can either trigger the gate from the source audio signal or via MIDI or CV.

When triggering the gate from the source audio signal, it works like this:

- **The gate “listens” to the source (dry) signal and opens whenever the signal reaches a certain threshold level.**
- **The reverb sound is sent through the gate - when the gate is closed you won’t hear the reverb.**
- **When the source signal level drops below the threshold level, the gate closes after a time that depends on the Hold parameter and the level of the source signal (see the parameter table).**
- **If you need the gate to be open for an exact duration (time), you should trigger it via MIDI or CV.**  
In audio trigger mode, the actual gate time will vary depending on the source signal.

When triggering the gate via MIDI or CV, it works like this:

- **The reverb sound is sent through the gate - when the gate is closed you won’t hear the reverb.**
- **Whenever the gate receives any MIDI note (sent to the RV7000 Mk II) or a gate signal (connected to the Gate Trig CV input on the back of the RV7000 Mk II), the gate opens for the duration of the note or gate signal.**

Note:

- **To activate the Gate, click the Gate Enable button on the main panel so that the indicator lights up.**
- **To make Gate settings, select “Gate” with the Edit Mode button to the left in the remote programmer panel.**
- **In this mode, the remote programmer display shows two meters - one showing the signal level (with an indication of the threshold level) and one showing the status of the gate.**

This is useful for checking what happens, how the gate triggers, etc.

The parameters for the Gate section are:

Parameter	Description
Threshold	When Trig Source is set to "Audio", this determines the audio signal level at which the gate opens. If you raise this setting, only very loud sounds will open the gate.
Decay Mod	This modulates the reverb Decay parameter so that the decay time is lowered when the gate closes. When this is set to zero, no decay modulation happens - this means that if the gate is closed and then opened again, you may hear "previous" reverb tails that are still ringing. If you raise the Decay Mod setting, the decay will automatically be lowered when the gate is closed, eliminating this effect.
Trig Source	Determines whether the gate should be triggered by audio or MIDI/CV, as described above.
High Pass	A high-pass filter that affects the audio that triggers the gate (only active when Trig Source is set to "Audio"). If you raise this setting, sounds with low frequencies only will not open the gate. Note that this setting doesn't affect the sound of the reverb, only the triggering mechanism.
Attack	Determines how long it takes for the gate to open after a triggering signal has been received.
Hold	This parameter is only active when Trig Source is set to "Audio". Hold affects how quickly the gate closes, in the following way: Internally, the gate is controlled by an envelope follower that analyzes the source signal level and generates a "level CV signal" accordingly. This signal is compared to the Threshold level to determine whether the gate should be opened or closed. The Hold parameter affects how quickly the envelope follower responds when the source signal level drops - you could say that this is the decay control for the envelope follower. The higher the Hold setting, the longer it will take for the envelope follower signal to drop below the threshold level and close the gate. But the resulting time also depends on the source signal level - with a loud signal, it will take longer time for the envelope follower to drop to the threshold level. Therefore, the actual gate time depends both on the Hold setting and on the character of the source audio.
Release	Determines how long it takes for the gate to close after the Hold time.

## CV Inputs



On the back of the RV7000 Mk II you find three CV inputs. These are:

Parameter	Description
Decay	Controls the reverb decay or echo/delay feedback via CV.
HF Damp	Controls the HF Damp parameter on the main panel.
Gate Trig	Used for triggering the Gate section with a gate signal. The length of the gate signal determines the length of the gated reverb.

**! Using the CV inputs to modulate the RV7000 Mk II in Convolution mode is not recommended.**

# **Chapter 44**

## **The Echo**

# Introduction



The Echo is an advanced stereo in/out echo and delay device with a multitude of parameters for tweaking the color and shape of the echo effect - diffusion, filtering, distortion and more. In addition to the normal mode where The Echo behaves like a regular send or insert effect, there are two additional modes called Triggered and Roll which let you automate momentary echo effects as well as create interesting stutter and repeat effects on the fly. The Echo also features breakout jacks which allow you to insert any number of other effect units into the feedback loop - this opens up endless possibilities for creative sculpting of the echo repeats.

## About the Patch format

The Echo features programmable effect presets. Included are a number of Factory Patches which can be used as-is or provide you with a good starting point for further tweaking. The Patches use the file extension "\*.echo". Loading and saving Patches is done in the same way as for instrument devices.

## Parameters

The Echo is comprised of six main sections; Mode (Normal, Triggered and Roll), Delay (time, tempo sync and stereo behavior parameters), Feedback (including a Diffusion subsection), Color (Drive and resonant Filter), Modulation (Envelope, Wobble and LFO) and Output (Dry/Wet control and Ducking).

## Common effect device parameters

While the parameters specific to The Echo are described in detail below, some features and procedures are common to all effect devices. Please refer to ["Common effect device features"](#) for further info about the Bypass On/Off switch. It should however be noted that the Input Meter on The Echo differs from the standard 7-segment LED meter found on other effect devices in Reason; The Echo features a 3-segment meter with the usual green, yellow and red LED (the latter indicates clipping).

## The Mode section

The Mode section acts as a signal gate with three different ways of passing the input signal on to the subsequent main sections.



### Mode

This switch has three positions:

- **Normal**  
The standard send/insert effect behavior where the input signal is fed continuously into the device.
  - **Triggered**  
This mode keeps the signal unprocessed until you hit the Trig button. This mode is for situations where you only want the echo effect momentarily, e.g. on every 4th snare hit, or individual words on a vocal track.
  - **Roll**  
In Roll mode, the unprocessed signal passes through unaffected until you turn up the Roll slider, see "[Roll slider](#)". This gradually suppresses the Dry signal while simultaneously raising the Feedback and mixing the delay/echo output into the Wet signal. The Roll mode is useful for repeat, stutter and glitch effects. For Roll mode, we recommend that the Dry/Wet parameter in the Output section (see below) is set to (or close to) Wet.
- See "[Using the Roll function](#)" for an example of how to use the Roll function.

### Trig

This button is only functional when the Mode switch is set to the Triggered position. When you press the Trig button it opens the Input signal gate, which stays open until you release the button again. Think of it as momentarily enabling an effect send.

### Roll slider

This slider is only functional when the Mode switch is set to the Roll position. The Roll slider does three things:

- **Turns up the feedback (internally) to unity (100%) or to the Feedback setting on the front panel, whichever is higher.**  
This starts happening during the slider throw, to catch a good amount of input signal.
  - **Closes the input to the delay (you don't want the delay to continue catching the input sound during the roll).**  
This happens late, with a slight delay - meaning it catches a little bit of sound after you've hit the Roll position.
  - **Changes the internal mix from dry to wet.**  
This also happens a bit late, so that if you hit a drum beat perfectly with the roll, you will hear that beat (dry) before the delay repeats (roll).
- ! **Note that the "internal mix" mentioned above is the signal sent to the "Wet" channel in Roll mode. The "Dry" channel still carries the dry signal at all times.**

The key thing here is that you shouldn't set the slider to a value in between - it should go from 0 to full Roll and back. So why do we use a slider and not a switch? Well, things start happening during the slider throw (and actually a bit after you've moved the slider fully to the right).

The slider allows for some sloppiness, making it easier to catch a beat and roll it fully. The result is slightly different depending on how fast you move the Roll slider - in most situations it works best to move it pretty fast and hit Roll exactly on the beat.

- Although you will probably most often set The Echo to full Wet when Rolling, it might make sense to have a little bit of dry signal leaking through during the roll (making it easier to keep time and return from the roll exactly on the beat). Then you just set Dry/Wet balance to something like 85% Wet, see **“Dry/Wet”**.
- See **“Using the Roll function”** for an example of how to use the Roll function.

## The Delay section



The Delay section features parameters relating to delay time, tempo sync and stereo behavior.

### Time

This knob controls the delay time. The delay time range is 1 to 1000 milliseconds. When Sync is enabled, the range is 1/128 notes up to 1/2 note.

### Offset R

This unipolar knob controls the Right channel delay time offset. The higher the Offset R value, the more the Right channel will be delayed in relation to the Left channel - perfect for creating stereo delay effects!

The Offset range is 1 to 1000 milliseconds. When Sync is enabled, the Offset range is “no offset” up to 1/2 note (according to the same resolution table as for the Time parameter). However, the 1/128 notes offset value is replaced by “no offset”.

### Keep Pitch

When you manually change the Delay time during recording or playback, you will notice that the pitch of the delay signal also changes. If this effect is undesirable, you can enable Keep Pitch, which will ensure that the pitch remains fixed regardless of changes in Delay time.

### Sync

This button enables Tempo Sync, which affects the Time and Offset R parameter.



## Ping-Pong

With Ping-Pong enabled, the stereo position of each delay repeat will alternate between left and right. The Pan knob determines the stereo width as well as the position of the initial repeat. When the Pan knob is set to full Left, the first delay bounce will be panned hard Left, the second will be panned hard Right, and so on. When the knob is set to full Right, the order is reversed (R > L > R etc).

## The Feedback section



The Feedback section consists of a main section with Feedback and Offset R controls, as well as a Diffusion subsection which allows you to add a kind of 'smearing' effect to the echo.

### Feedback

The Feedback knob sets the amount of feedback, i.e. the amount of wet signal fed back into the delay. This determines the number of repeats. At zero feedback there will only be a single repeat. Unity gain is achieved at 100%. If you increase the feedback beyond this it will increase the gain so a distorted signal is produced.

### Offset R

This bipolar knob controls the offset in delay Feedback on the right channel. By default, both channels have the same amount of feedback (as determined by the Feedback parameter), but the Offset R knob allows you to add or subtract feedback separately for the Right channel only. The practical result is that you will hear the echo gradually wander from the center to the left or right side.

This control combined with the Offset R in the Delay section can be useful for controlling the length of the effect for the right channel.

### Diffusion

Diffusion introduces kind of a "smearing" effect, somewhat reminiscent of diffusion on a reverb. Raising the Amount will introduce additional delay repeats very near the 'original' repeats, and raising the Spread value will spread these repeats out wider.

## The Color section



This section features a distortion/limiter and a resonant filter. Each echo repeat is colored before being fed back into the loop, meaning that the distortion and filter effects will be more pronounced with each repeat.

### Drive

This knob sets the amount of the selected distortion/limiter effect.

### Type

The Type Switch lets you select between 4 different effect algorithms:

- **LIM (Limiter)**  
This produces that typical “compression” effect which you would get from analog limiters.
- **OVDR (Overdrive)**  
This produces an analog-type overdrive distortion effect.
- **DIST (Distortion)**  
Similar to overdrive, but denser.
- **TUBE**  
This emulates tube distortion.

### Filter

This is a resonant bandpass filter, hence it lets you create filter effects where either the lower or the higher frequency range is cut (or boosted, in case the Reso control has been turned up).

### Freq

This control sets the change in frequency. For each delay repetition, the frequency content will shift in accordance with the frequency setting.

### Reso

This knob determines the amount of resonance on the delay repetitions. A different frequency range will be amplified depending on the setting of the Freq parameter.

## The Modulation section



This section features parameters for modulating the pitch and stereo image of the echo effect.

### Env

The envelope parameter lets you create a kind of bend effect where the pitch of the echo repeats wanders down or up, depending on whether you turn the knob left or right. The knob is bipolar, meaning that there is no Env effect in the default middle (zero) position.

### Wobble

This emulates a tape speed wobbling effect where the speed of the “tape” (and consequently, the pitch of the signal) wobbles randomly.

### LFO

The LFO subsection modulates the pitch of the left and right channels independently, meaning that it functions as a kind of stereo spread at modest settings and warps the echo completely at heavier settings.

### Rate

This knob sets the speed of the LFO.

### Amount

This knob sets the amount of LFO.

## The Output section



This section is the final output stage where the processed effect signal goes through the standard Dry/Wet control, as well as the optional Ducking control.

### Dry/Wet

This is a traditional dry/wet parameter for controlling the relation between the unprocessed and the processed signal. When Roll mode is enabled (see the Mode section for more info), we recommend that the Dry/Wet control is set to Wet only even when The Echo is used as an insert effect.

### Ducking

Ducking attenuates the level of the Wet (processed) signal until the amplitude of the Dry signal drops, at which time the Wet signal is faded back in. This is useful for adding a delay effect to the silence that comes after you have played your lovely lead line. The delay will not be heard while you are still playing so you will avoid muddling up the solo.

# CV/Gate inputs



On the back of The Echo you will find the following CV inputs:

## Trig

This is a Gate input for controlling the Trig function in the Mode section.

## Roll

Use this for dynamically changing the Roll amount (corresponding to the Roll slider on the front panel) in the Mode section.

## Delay Time

Use this for dynamically changing the Delay Time in the Delay section.

## Filter Freq

Use this for dynamically changing the Filter Frequency in the Color section.

# The Breakout Jacks



The Echo features special Breakout jacks which allow you to insert other effect devices into the feedback loop. The signal is processed externally and then fed back into the loop, meaning that each delay repeat will be more colored by the effect(s) connected to the breakout jacks.

# Tips and Tricks

## Using the Roll function

Here's a quick example of how you can typically use the Roll function in The Echo:

- 1. Have some signal running through The Echo, e.g. a drum loop.**
- 2. Set The Echo to Roll mode and full Wet output (see “Dry/Wet”).**  
The Roll slider is at 0. You will hear the drum loop unprocessed, since Roll isn't engaged yet.
- 3. On the beat you want to roll (or freeze, to use another term), move the Roll slider quickly all the way to the right.**  
This replaces the dry signal with that beat, being rolled at whatever delay time you set.
  - **A nice thing is to set the Delay to Sync mode (see “Sync”) so the repeats will be in sync with the loop, e.g. to 1/16th notes or other desired resolution.**
- 4. To go back to the (dry) loop, move the Roll slider quickly back to 0.**

## Creating “pitched” delay

- 1. Set the delay time to minimum (1ms).**
- 2. Increase feedback to 100%.**
- 3. Enable Diffusion and increase the Amount to maximum.**
- 4. Play a drum loop or similar through The Echo.**

Now you have set up a sonic playground that equals no other delay! Experiment with Diffusion Spread, Modulation Env and Delay Time to achieve various interesting sonic results.

## Distorted external feedback

- 1. Connect an instrument device to the input(s) of The Echo.**
- 2. Connect a Scream 4 device in the feedback loop.**  
Connect the Scream 4 inputs and outputs to the Breakout jacks of The Echo, see “The Breakout Jacks”.
- 3. Play the instrument device and try different distortion algorithms on the Scream 4.**  
Be careful with the master volume in Scream 4 as this is very sensitive to the feedback level in The Echo.

# **Chapter 45**

## **BV512 Vocoder**

# Introduction

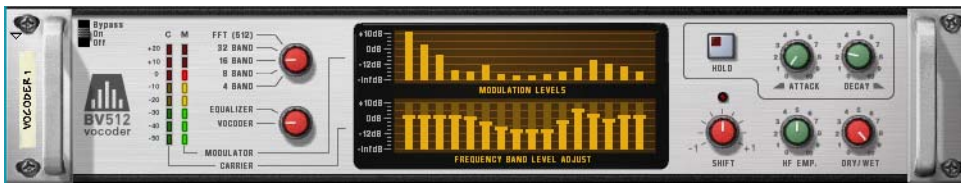

The BV512 is an advanced vocoder device with a variable number of filter bands. It also has a unique 1024-point FFT vocoding mode (equivalent of 512-band vocoding) for very precise and high quality vocoded speech. By connecting the BV512 to two instrument devices, you can produce anything from vocoded speech, singing or drums to weird special effects.

Even if you have worked with a vocoder before, please read the following section. Knowing the basic terms and processes will make it much easier to get started with the BV512!

## How does a vocoder work?

### Carrier and modulator

A vocoder accepts two different input signals, a “carrier” and a “modulator”. It analyzes the modulator signal, applies its frequency characteristics to the carrier signal and outputs the resulting “modulated” carrier signal.

In the most typical case, the carrier signal is a string or pad sound and the modulator signal is speech or vocals - the result will be a talking or singing synth sound. The modulator could also be drums or percussion (for rhythmically modulated sounds and effects) or any sound with changing frequency content.

### Filter bands

Technically, a vocoder works in the following way: The modulator signal is divided into a number of frequency bands by means of bandpass filters (called the “modulator filters” or “analyzing filters”). The signal in each of these bands is sent to a separate envelope follower (which continuously analyzes the level of the signal). The carrier signal is sent through the same number of bandpass filters (the “carrier filters”), with the same frequency ranges as the filters for the modulator signal. The gain of each bandpass filter is controlled by the level from the corresponding envelope follower, and the filtered signals are combined and sent to the vocoder’s output.

In this way, the carrier is filtered to have roughly the same frequency characteristics as the modulator. If the modulator signal has a lot of energy in one of the frequency bands, the gain of the corresponding filter band for the carrier signal will be high as well, emphasizing those frequencies in the output signal. If there is no signal at all within a frequency band in the modulator signal, the corresponding band in the output signal will be silent (as the gain will be zero for that filter).

There are several factors determining the quality of the vocoder sound, but the most important is the number of filter bands. The larger the number of filter bands, the closer will the output signal follow the modulator’s frequency characteristics. The BV512 offers 4, 8, 16 or 32-band vocoding.

- **Even if a high number of bands will make the sound more precise and intelligible, this isn’t always what’s desired! Vocoding with a lower number of bands can give results that sound different, fit better in a musical context, etc.**

### FFT vocoding

The BV512 has an additional FFT mode, in which the vocoding process isn’t based on bandpass filters as described above. Instead, FFT (Fast Fourier Transform) analysis and processing is used. This equals 512 “conventional” frequency bands and results in a very precise and detailed vocoder sound. Note:



- **The FFT mode is best suited for vocoding speech or vocals, giving crystal clear and highly intelligible results.** It is not so well suited for vocoding drums and percussion, since the FFT process is inherently “slower” than the regular filtering and doesn’t respond as quickly to transients, and also there will be a slight delay added to the signal (in the region of 20ms). A workaround solution to this would be to move the modulator signal slightly ahead to compensate for the delay.
- **Where the conventional filter bands are distributed logarithmically (i.e. the same number of filter bands per octave), the 512 bands in the FFT mode are distributed linearly.** This means a lot of the bands will be in the high frequency range - this is one of the reasons for the clear sound but it is also something to keep in mind when making settings for the vocoder in FFT mode.

## Setting up for basic vocoding

This tutorial describes how to connect and use a typical vocoder setup. We assume here that you have a MIDI keyboard connected. For details on the parameters, see [“BV512 parameters”](#).

### Vocoding vocals in real-time

The most common usage for a vocoder is probably the typical “singing” or “talking synth” sound, using vocals or speech as modulator. Since Reason supports live audio input you can sing and play in real time. This is a basic example of how to route your signals:

**1. Create the instrument device you want to use for the carrier signal.**

This could typically be a synth or a sampler. In this example we choose a Subtractor synthesizer.

**2. Set up the carrier device (Subtractor) for a sustaining, bright sound.**

It’s important to have high frequencies (a lot of harmonics) in the carrier. On the Subtractor, a simple but effective carrier sound would be based on a sawtooth wave, with the filter fairly open. For more about choosing carrier sounds, see [“Choosing a carrier sound”](#).

**3. Select the carrier device (Subtractor) and create a BV512 Vocoder.**

If you flip the rack around you will see that the Vocoder is automatically routed as an insert effect for the carrier device (using the Carrier Input jacks).



**4. Connect a microphone to your audio interface and manually patch the appropriate Audio in jack on the Reason Hardware Interface to the Modulator Input on the BV512.**

**5. Make sure the Master Keyboard Input is set to the carrier device track.**

**6. Also make sure the “Dry/Wet” knob on the BV512 Vocoder is turned to “Wet” (fully clockwise).**

7. Play some notes or chords on your MIDI keyboard and sing through the microphone. The result will be the classic vocoded vocal sound.

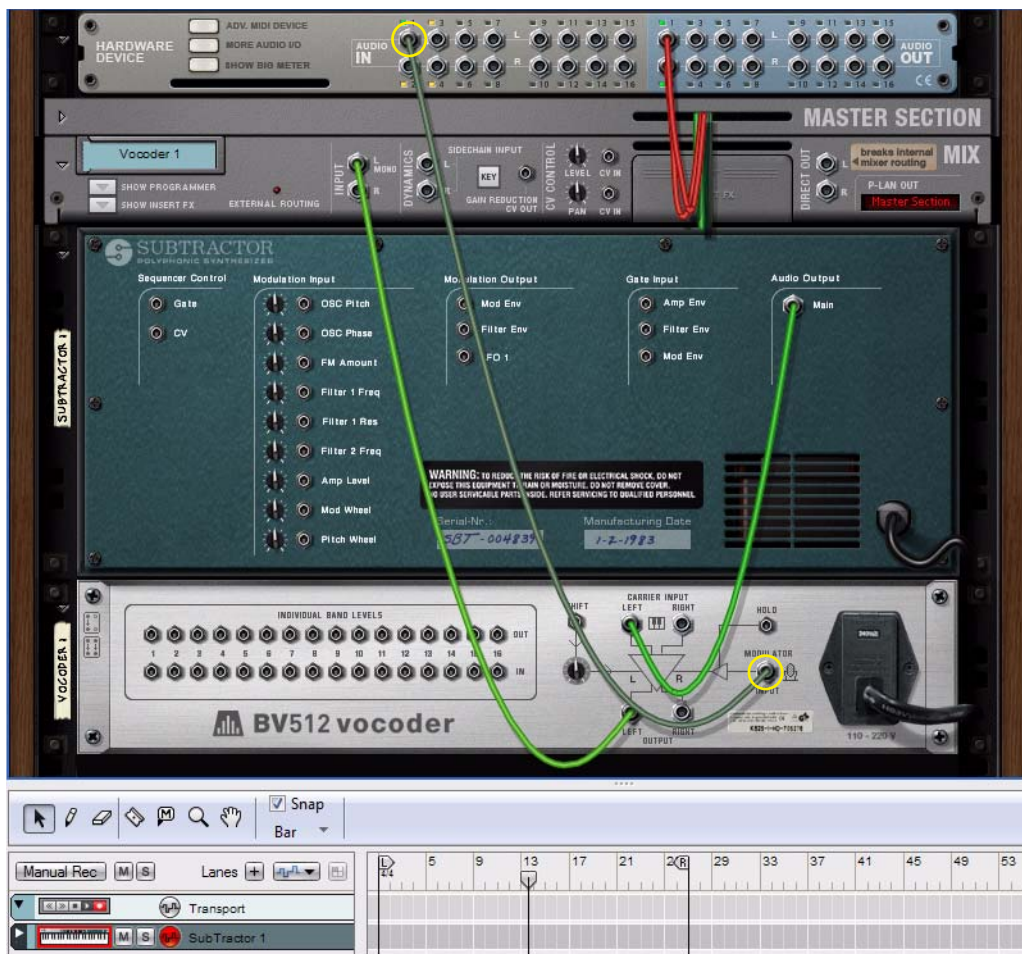

8. Try the different filter band options and note the difference in sound.

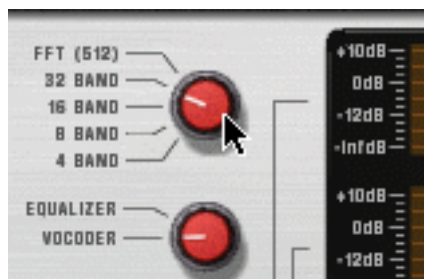

**9. You can also adjust the vocoder sound by clicking and dragging the bars in the lower display.**

Each bar corresponds to a frequency band, with low frequencies to the left and high frequencies to the right. You adjust the level of a band by dragging its bar up or down. Clicking and dragging across the bars allow you to change the levels of several bars, much like drawing an eq curve.

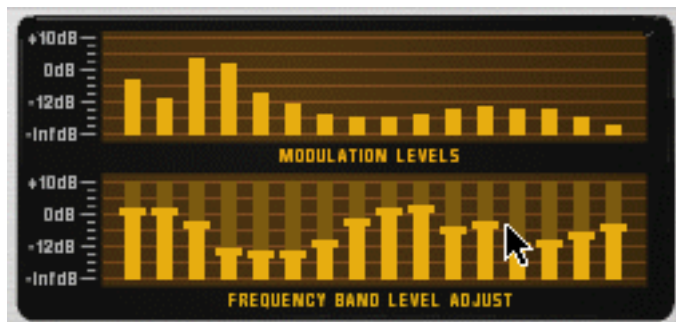

*The upper display shows the spectrum of the modulator signal, for display only.*

→ **To reset a band to  $\pm 0$  dB, press [Ctrl](Win) or [Cmd](Mac) and click on it.**

You can also reset all bands to zero by bringing up the context menu for the Vocoder device and selecting “Reset Band Levels”.

**10. If the vocoder sound is “muddy” or indistinct, try raising the “HF Emph” knob on the Vocoder.**

This parameter (High Frequency Emphasis) boosts the high frequencies in the carrier signal.

**11. Try out the other parameters if you like.**

See [“BV512 parameters”](#) for details.

## Recording the vocoded audio

If you want to record the vocoded audio in the example above on an audio track in the sequencer, you can do like this:

- 1. Create an audio track.**
- 2. Click the “Rec Source” button on the Vocoder Mix Channel device in the rack.**
- 3. Select the Vocoder Mix Channel as input in the Audio Input selector on the audio track in the sequencer.**
- 4. Select the carrier device (Subtractor) track in the sequencer and deselect its “Record Enable” button.**
- 5. Click the “Record Enable” button on the audio track in the sequencer (but don’t select the audio track!).**
- 6. Click the “Rec” button on the Transport Panel to start recording.**

The vocoded audio is now recorded on the audio track as you sing through the microphone and play the keyboard.

Refer to [“Recording audio from Mix Channel outputs”](#) for more details on how to record Mix Channel outputs.

## Vocoding an existing audio track

If you want to apply vocoding to an existing audio track, but also keep the original sound, a flexible way is to do like this:

- 1. Create the carrier device (a Subtractor, for example).**
- 2. Select the carrier device and create a BV512 vocoder.**
- 3. Patch a cable from the left Insert FX “To Device” connector of the audio track device to the Modulator Input on the BV512.**
- 4. Set Master Keyboard Input to the carrier track.**
- 5. Click “Play” in the sequencer and play some notes or chords on your MIDI keyboard.**

The result will be the classic vocoded vocal sound.

- If you don't want the original sound of the audio track to sound, click the Mute button on the channel strip in the Main Mixer (or lower the Level Fader to silence).



6. At this point you may want to record the notes or chords you play for the carrier device. As Master Keyboard Input is already set to the carrier device track, all you need to do is start recording and play along.

# Using the BV512 as an equalizer

The BV512 has a unique equalizer mode, in which the device works purely as an insert effect (the modulator input isn't used). This allows you to use the processing filters of the vocoder as a kind of graphic equalizer.

## Setting up

1. **Select the device that you want to process through the BV512.**

2. **Create a BV512 device.**

It is automatically connected as an insert effect, using the Carrier Input jacks.

3. **Set the switch to the left of the displays to "Equalizer".**



## In use

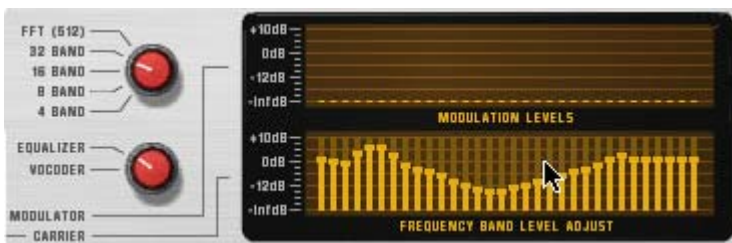

In equalizer mode, you cut or boost frequencies by clicking and dragging in the lower display - just as with a regular graphic equalizer. The usage and results differ depending on which mode is selected:

- **4 - 32 band mode**

As in vocoder mode, the number of bars in the display conforms to the number of bands selected (4, 8, 16 or 32). With a higher number of bands you get a more detailed control over the frequency response. However:

→ **In these modes, the equalizer will "color" the sound even if all bands are set to  $\pm 0$  dB!**

This is due to phase interaction and overlap between the bandpass filters.

Therefore you probably want to use the 4 - 32 band mode for coloring and mutating sounds - not for subtle, "clean" equalizing.

- **FFT (512) mode**

In FFT (512) mode you still get 32 bars in the display, but the each bar may control several frequency bands (remember that there are 512 bands in FFT mode). Since the frequency bands are distributed linearly in FFT mode, bars to the left in the display control few frequency bands while bars to the right control many frequency bands.

→ **In FFT (512) mode, setting all bands to  $\pm 0$  dB is the same as bypassing the equalizer - the sound will not be affected.**

This makes FFT mode suitable for "clean" equalizing, where you want to boost or cut some frequencies without changing the basic sound character.

→ **However, FFT mode equalizing is not suited for very drastic frequency cuts or boosts, as this may give audio artefacts due to the workings of FFT processing.**

Still: as always, there are no hard and fast rules. Let your ears judge!

→ **Keep in mind that FFT mode also introduces a slight delay to the signal.**

# BV512 parameters

On the front panel of the BV512 Vocoder, you will find the following parameters and displays:

Parameter	Description
Bypass/On/Off switch	In Bypass mode, the carrier signal passes through the device unaffected and the modulator signal is disregarded. In On mode, the device outputs the vocoded or equalized signal. Off mode cuts the output, silencing the device.
Level meters	Show the signal level of the carrier and modulator signals, respectively.
Band switch	Selects the number of filter bands (4, 8, 16 or 32) or FFT (512) mode.
Equalizer/Vocoder switch	Determines whether the BV512 should work as a vocoder or an equalizer. In Equalizer mode, the Modulator input is disregarded.
Modulation level display	The upper display shows the spectrum of the modulator signal.
Frequency band level adjust	The lower display allows you to adjust the level of each filter frequency band, by clicking and dragging the corresponding bar. In vocoder mode this affects the vocoded sound. In equalizer mode, this is where you cut or boost frequencies. To reset a band to $\pm 0$ dB, press [Command] (Mac) or [Ctrl] (Win) and click on its bar in the display. To reset all bands, select "Reset Band Levels" from the device context menu. Note: when FFT (512) mode is selected, each of the 32 bars in the display corresponds to several frequency bands, with bars to the right in the display controlling progressively more bands (due to the FFT bands being linearly distributed over the frequency range).
Hold button	Clicking this button "freezes" the current filter settings. While the button is lit, the modulator signal doesn't affect the sound - the carrier signal is filtered with the settings as they were the moment you activated Hold. Click the button again to turn off Hold. Hold is also automatically reset (turned off) when you stop sequencer playback - just like the pitch bend and modulation wheels on synth devices. This function can be controlled via CV or MIDI, for sample and hold-like effects. The Hold button is not available in Equalizer mode.
Attack	This is a global attack time control, affecting all envelope followers (see "Filter bands"). Normally you probably want this set to zero, to make the vocoder react as quick as possible. Raising the Attack time can be useful for "smearing" sounds, creating pads, etc. Not available in Equalizer mode.
Decay	Similarly, this controls the decay time for all envelope followers, i.e. how quick the filter band levels drop. Adjust this according to taste and context. Not available in Equalizer mode.
Shift	Shifts the carrier filters up or down in frequency, drastically changing the character of the vocoded (or equalized) sound. This parameter can be controlled via CV, for phaser-like sweeps and special effects.
HF Emph (High Frequency Emphasis)	Boosts the high frequencies in the carrier signal. This is sometimes desired to get a clearer vocoded sound. The reason is that a carrier signal should theoretically contain roughly equal energies in all frequency ranges for best results - in a typical synth sound the high frequencies are often weaker than the low frequencies. Raising the HF Emph control will rectify this. Not available in Equalizer mode.
Dry/Wet	Determines the balance between modulator sound (dry) and vocoded sound (wet). To get the pure vocoder sound, set this to wet (turned fully right). Not available in Equalizer mode.

# Connections



The back panel of the BV512 offers the following connections:

## Individual band levels

These are CV outputs and inputs.

- **The upper row outputs CV signals generated by the envelope followers for each frequency band.**
- **The lower row are CV level inputs to the individual bandpass filters through which the signal is processed (the “vocoder filters”).**

Connecting a CV signal to one of the inputs breaks the internal signal path from the corresponding envelope follower (in other words, that frequency band is now controlled by the CV signal you’ve connected - not by the corresponding frequency band in the modulator signal).

- **If 16 band mode is selected, each output/input pair corresponds to a separate frequency band.**

In 8 band or 4 band mode, only the 8 first or 4 first output/input pairs are used. In 32 band mode, each output is a mix of two adjacent frequency bands and each input controls two bands. Finally, in FFT (512) mode each output/input pair corresponds to several frequency bands.

There are several interesting uses for the Individual band levels connectors: you can cross-patch frequency bands so that e.g. low frequencies in the modulator signal controls high frequency bands in the vocoder, you can extract CV signals for controlling synth parameters in other devices, you can base the vocoding on CV signals from other devices rather than on a modulator signal, etc. See [“Using the individual band level connections”](#) for details.

## Other CV connections

Connection	Description
Shift (CV in)	This allows you to control the Shift parameter from an external CV source. A sensitivity knob determines how much the Shift setting is affected by the CV signal.
Hold (Gate in)	When a gate signal is sent to this input, the Hold function is activated (see <a href="#">“Hold button”</a> ). Hold remains on until the gate signal “goes low” (falls to zero). By connecting e.g. a Matrix to this input, you can create “stepped” vocoder sounds, sample and hold-like effects, etc.

## Audio connections

Connection	Description
Carrier input	This is where you connect the instrument device that provides the carrier signal (or the device to be processed in Equalizer mode) - typically a synth or sampler device. The vocoder can handle mono or stereo carrier signals.
Modulator input	This is where you connect the instrument device that provides the modulator signal, in mono. This connection is not used in Equalizer mode.
Output	In Vocoder mode, the outputs carry a mix between the vocoded signal and the modulator signal (as set with the Dry/Wet control on the front panel). In Equalizer mode the output is the carrier signal, processed through the equalizer filter. Note that the output will be in mono if the Carrier input is in mono, and vice versa - the BV512 does not process mono into stereo.

# Automation

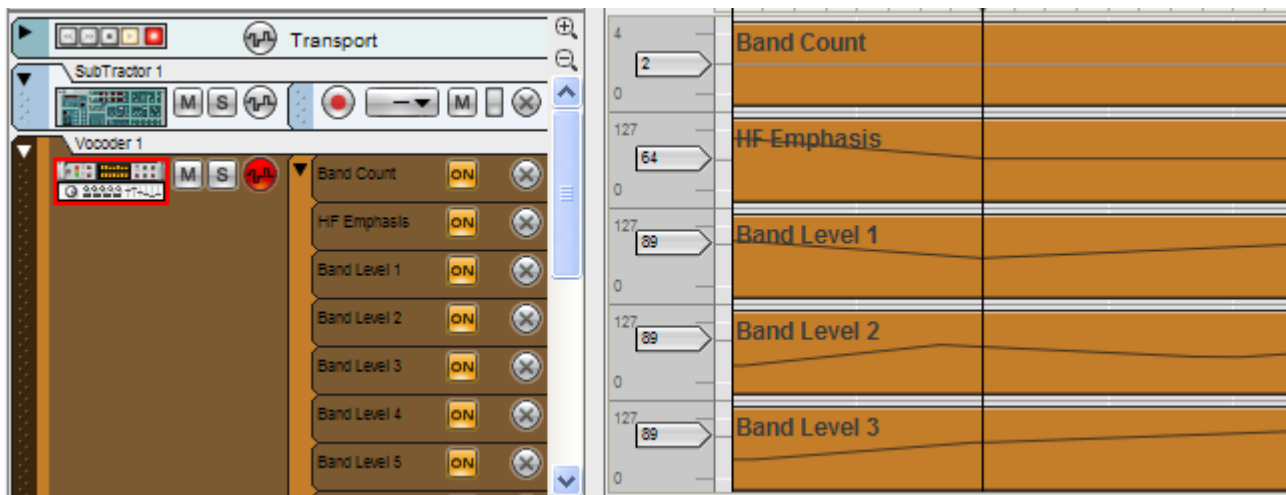

All parameters on the front panel can be automated in the standard manner. The individual band levels (the bars in the lower display) will be edited on separate lanes in the sequencer. Note:

- **As with the other effect devices, you have to manually create a sequencer track for the BV512.**
- **Although the band level adjustments can be edited individually, they are treated as one automatable parameter on the device panel.**

This means that if any single band level control is automated, there will be a frame around the whole lower display on the device panel. Right-clicking (Win) or [Ctrl]-clicking (Mac) in the lower display and selecting “Clear Automation” will remove the automation for all bands. Similarly, selecting “Edit Automation” will open the sequencer with lanes for all band levels shown.

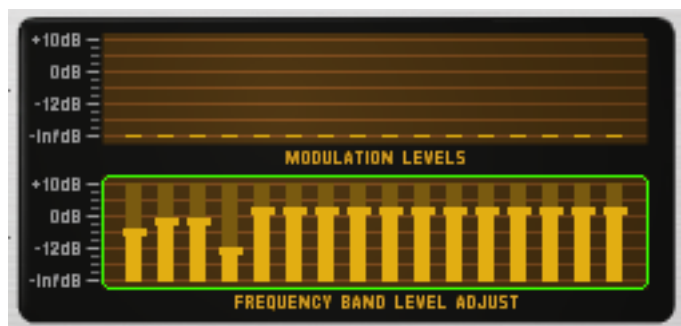

*The frame indicates that one or more band level controls are automated.*



# Tips and tricks

## Choosing a carrier sound

As always, which carrier sound to choose is a matter of taste and musical context. However, here are a few guidelines to help you get a good result:

- **The carrier sound should preferably have a lot of harmonic content (brightness) - dark or muffled sounds will not “give the vocoder much to work with”.**
- **Often, you want the carrier sound to sustain at an even level (i.e. it shouldn’t “die out” when you hold a chord). Similarly, you most often want a reasonably fast attack (although not with a distinct, sharp click or edge).**
- **You may want a sound that is rather static over time, without drastic envelope control of filter cutoff for example.**
- **If you want to play vocoded chords, the carrier sound must of course be polyphonic.**

Here are some hands-on suggestions for carrier sounds:

### → A simple Subtractor pad based on a sawtooth waveform.

You could simply start with the initial patch (as set up when you create a new Subtractor device). Open the filter, turn off envelope modulation of the cutoff frequency and raise the Amp Envelope Sustain.

If you want a classic, rich chorus-like sound, use two detuned oscillators - or better still, add a UN-16 Unison device as an insert effect between the Subtractor and the vocoder!



*A simple but effective carrier sound setup.*

### → A similar fat carrier sound can be obtained using a Malström device with a patch based on the “Sawtooth\*16” graintable.

With the Malström you can get a stereo carrier signal with no extra devices: simply select the “Sawtooth\*16” graintable for both oscillators, detune the oscillators slightly with the Cent controls and raise the Spread parameter to the desired stereo width. No filter routings are necessary.

### → For a more distinct and precise sound, try using a narrow pulse waveform.

You get this by selecting e.g. a sawtooth wave on the Subtractor, setting the Phase Mode selector to “-” and turning the Phase knob to the left until you get the desired sound. This type of carrier sound lends itself well to monophonic vocoder lines in the lower registers.

### → Use noise as a carrier.

Try using pure noise (possibly filtered down a bit) for robotic voices, whispering and special effects. It's also very useful to add a bit of noise to a sawtooth or pulse sound - this makes vocoded speech clearer and more intelligible.

→ **Use sampled strings or choir sounds.**

A rich drawbar organ sample can also be a cool carrier sound.

→ **For unusual vocoder sounds, try using the Malström as carrier device, e.g. with a glassy, digital pad sound selected.**

Try turning up the Attack and Decay controls on the BV512, for smeared, rhythmic or pseudo-random modulation of a pad.

## Choosing a modulator sound

The modulator sound should typically have varying level and harmonic content. As we've already mentioned, the most typical modulator sounds are vocals or speech and drums or percussion.

→ **To use your own voice as modulator sound, refer to [“Using the BV512 as an equalizer”](#).**

→ **The quickest way to get an “internal” modulator sound is to use a rhythmic loop in the Dr. Octo Rex device.**

This way you don't have to program a rhythm pattern. On the other hand, using a Redrum as modulator allows you to create exactly the rhythm you want and fine-tune the sounds and the groove.

## Using the modulator as carrier

You can get cool special effects by using the same device both as carrier and as modulator. For example, try processing a Redrum device in the following way:

1. Create a Redrum device and set up the desired patch and pattern.
2. Create a Spider Audio Merger & Splitter device.
3. Create a BV512 Vocoder.
4. Flip the rack around and connect the devices in the following way:



*The output of the Redrum goes into the splitter section of the Spider, and is split into two signals. One signal goes into the carrier input of the vocoder, the other goes into the modulator input.*

This is essentially the required connections, but for best results it's a good idea to add some distortion and/or compression to the carrier signal - this increases the amount of high frequencies in the carrier signal:

5. Press [Shift] and create a Scream 4 distortion device.
6. Connect the distortion device as an insert effect between the Spider and the carrier input of the vocoder.

Now, the carrier signal will be processed in the distortion device, but not the modulator signal.

7. Play back the pattern and experiment with the settings on the vocoder and distortion device.

- This technique can also be used to process vocals and speech.
- Try adjusting the Shift parameter for new effects and sounds.

Remember that you can route CV to the Shift parameter on the back of the BV512 - use e.g. a Matrix or an LFO output on a synth device!

## Controlling the Hold function

As described in “Hold button”, pressing the Hold button on the front panel “freezes” the current filter spectrum until you deactivate it again. This can be used for creating sample & hold-like effects, stuttering or garbled vocoder sounds:

- **Connect e.g. the Gate output on a Matrix device to the Hold input on the back of the BV512.**  
By playing back a gate pattern on the Matrix, the Hold function will repeatedly be turned on and off according to the programmed rhythm in the pattern. Hold will be active for the length of each gate signal.
- **Automate the Hold function with the main sequencer, either by recording it or by drawing in its controller lane.**
- **If you route MIDI to the BV512 you can control the Hold function in two ways by default: By pressing a damper pedal connected to your MIDI controller or by playing the note C4.**  
In both cases, the Hold function will be momentary - Hold is on until you release the pedal or key.

## Using the individual band level connections

As described in “Individual band levels”, the individual band level connectors on the back are CV output and input jacks. The upper row sends out the CV signals from the envelope followers for the different frequency bands, while the lower jacks are CV inputs for controlling the individual bandpass filters (breaking the internal connection from the envelope followers). There are several interesting things you can do with these connections:

### Crosspatching frequency bands



By connecting outputs to inputs in alternative configurations, you can drastically change the result of the vocoding. For example, you could have low frequencies in the modulator signal give high frequencies in the vocoded sound and vice versa. Note:

- **In 4 band and 8 band mode, only the 4/8 first output/input pairs are used.**
- **In 32 band mode and FFT (512) mode, each connection corresponds to two or several frequency bands.**  
This means that connecting an output to the input with the same number is not the same as using the internal signal path (no CV cable connected). You can hear this quite clearly in FFT (512) mode: connect all outputs to the corresponding inputs and gradually remove the CV cables while listening to the vocoder sound - the sound will progressively get more detailed.

## Extracting CV from the vocoder

You can connect an individual band level output to any CV input on any device. This means you can use the vocoder as an envelope follower, having elements in the modulator sound control a parameter in another device, e.g. an effect. Note:

- **The Attack and Decay settings on the BV512 panel affect the envelope followers, and thus the rise and fall times of the CV signals from the individual band level outputs.**
- **If you are using the vocoder in a mode with many bands, but want a broader frequency range to generate the CV signal, you can merge several band outputs into one CV signal - use a Spider CV Merger & Splitter device.**

## Controlling vocoder bands from an external source

Connecting a CV source to an individual band input breaks the internal connection from the corresponding envelope follower. This way you can “manually” control the vocoder filters. Some applications:

- **Connect the CV outputs for one or more envelopes in the carrier device to individual band inputs.**

When you play the carrier instrument, one or more of the bandpass filters in the vocoder will automatically open, adding an extra attack to the sound. Useful if you really want to “play” the carrier, rather than just hold a chord.

- **Connect the gate outputs on a Redrum to individual band level inputs.**

With this connection (and no device connected to the Modulator input), the Redrum will serve as a pattern sequencer, opening and closing different filter bands. To adjust the gate times, set the drum sounds to Gate mode and use the Length parameter. The result is totally different from using the audio signal of the Redrum as modulator.



*The vocoder bands are now solely controlled by the gate signals from the drum channels - the modulator input isn't used. Note that you can use a Spider CV Merger & Splitter device to split a gate signal, sending it to several bands. Also, note that the velocity of the programmed drum notes govern the level of the corresponding filter bands.*

## “Playing” the vocoder from a MIDI keyboard

If you have routed MIDI to the BV512, playing notes from C1 and up will control individual filter bands. For example, in 16 band mode, C1 controls band 1, C#1 band 2 and so on up to D#2 (which controls band 16).

- **The level of the bands is proportional to key velocity (how hard you play).**
- **A band will be “open” until you release the corresponding key.**
- **Bands to which you have connected a CV signal (using the individual band level inputs on the back panel) will not respond to MIDI keys.**

Note that with this function, you “play the modulator bands”. However, you still need both a carrier and a modulator signal to get any sound. Typically, you would first record the notes or chords for the carrier device in the sequencer, then create a sequencer track for the vocoder and “play” it from your MIDI keyboard while playing back the recorded carrier notes and at the same time inputting a signal on the Modulator input.

- **An interesting application of this is to patch the vocoder as an insert effect for the whole mix (the output of the main mixer connected to the carrier input), and “play the vocoder” while inputting a signal on the Modulation input. Only the frequency bands for which you press keys will be attenuated. Use the FFT (512) mode for best results.**

## Using the BV512 as a reverb

This is a very special trick which can be quite cool. Proceed as follows:

### 1. Create a Redrum device.

The “vocoder-reverb” is best suited for drums, even though nothing stops you from using it on other sounds.

### 2. Create a Subtractor and a vocoder.

The Subtractor will automatically be routed to the carrier input. We don’t need a dedicated modulator device in this setup.

### 3. Flip the rack around and connect Aux send 1 on the Mixer to the modulator input on the vocoder.

### 4. While you’re there, re-route the vocoder output to Aux return 1.

This way, our vocoder-reverb will be connected as a regular send effect.



5. Set the vocoder to FFT (512) mode, turn the Decay knob to between 6 and 7 and turn the Dry/Wet control to “wet” (fully right).
6. On the Subtractor, set up a noise sound as follows:
  - Turn the Oscillator Mix knob fully to the right.
  - Turn on the Noise section (but make sure Osc 2 is off).
  - In the Noise section, turn Color to around twelve o’clock.
  - Open the filter fully and make sure resonance is set to 0.
  - Make sure Filter Envelope Amt is 0 (and turn off velocity modulation).
  - Raise the Sustain to full in the Amp Envelope section.



Now we want the Subtractor to play a continuous noise. You could just route MIDI to it, play a note and keep it pressed, but that will probably wear you out in the long run. Better to use a Matrix:

7. **Create a Matrix and route it to the Subtractor.**  
We really only need the Gate connection - the note number isn't important with the noise patch.
8. **Set up a one step pattern with a tied gate (press [Shift] and draw the gate) and start playback on the Matrix.**  
Now the vocoder gets a continuous noise signal as carrier.
9. **Create a suitable drum pattern on the Redrum and start pattern playback.**
10. **Gradually turn up send 1 for the Redrum channel in the mixer.**  
This now serves as a balance control between the dry drum sound and the reverb, generated by the vocoded noise! Set it to a suitable reverb level.
11. **Use the Decay control on the vocoder to adjust the reverb decay time.**
12. **Use the Noise Color control on the Subtractor to make the reverb darker or brighter.**  
You could use the filter cutoff for this as well.

That's it - a pretty good reverb sound with a lot of control. Although the settings above give the most natural sound, you can vary the sound and create special-FX reverb in the following ways for example:

- **Switch the vocoder to a lower band mode.**
- **Lower the cutoff and add some resonance in the Subtractor filter.**
- **Modulate the Subtractor filter with a fast LFO.**
- **Set the Subtractor filter to HighPass mode to remove the bottom end from the reverb.**
- **Turn off the Matrix controlling the Subtractor and “play” the noise patch yourself (or from the sequencer). This way you can create gated reverb effects, etc.**

## Creating a stereo reverb

What you've got above is a mono reverb. Here's how to make it stereo:

1. **Select the Subtractor and create a Spider Audio Merger & Splitter device.**
2. **Create a DDL-1 delay.**
3. **Connect the devices in the following way:**

The Subtractor output should be routed to a Splitter input on the Spider. One split output should be routed to one of the carrier inputs on the vocoder, the other split output should be routed to the delay. The delay output (mono) should be routed to the other carrier input on the vocoder.



*The vocoder will now get a "fake-stereo" noise carrier signal.*

4. **Make sure the output from the vocoder is connected in stereo to the Aux return on the Mixer.**
5. **Finally turn down the Feedback on the delay, set it to all "wet" and set the decay time to a second or so.**

When you now start playback on the Redrum, the reverb will be in stereo!



# **Chapter 46**

## **Neptune Pitch Adjuster and Voice Synth**

# Introduction



The Neptune Pitch Adjuster and Voice Synth device is a combined monophonic vocal pitch corrector, pitch shifter and polyphonic voice synth. Neptune was designed with focus on high-quality vocal processing but can also be used on other material. However, due to the signal characteristics of other types of audio (complex inharmonic instrument sounds, polyphonic material etc.) the result of the pitch adjustments might not be what you would expect. Don't hesitate to experiment, though!

Used as a pitch corrector, Neptune can automatically correct flat monophonic input signals and output corrected notes in real-time. The pitch correction can be adjusted from totally transparent to hard, robot-like. The correction can be controlled from predefined scales, from input MIDI notes or from a combination of both!

When used as a pitch shifter, Neptune performs overall pitch-shifting of incoming monophonic audio in real-time and transposes the output to a defined value within a  $\pm 1$  octave range.

The Voice Synth section in Neptune allows you to add additional voices - harmonies - to a monophonic vocal input signal and to control the voices via MIDI - from sequencer notes or by playing on your MIDI master keyboard.

Neptune also features controls for adjusting formants and for adding pitch bend and vibrato to the processed signal.

## Typical use cases

Neptune can be used in a variety of ways and situations. Here are some examples:

- **Transparent pitch correction of a vocal track**  
Neptune is used as an Insert Effect on the vocal audio track, with the Pitch Adjust's Scale set to desired scale. The Correction Speed parameter is set to a moderate value.
- **Hard pitch correction of a vocal track (the "Cher/T-Pain effect")**  
Neptune is used as an Insert Effect on the vocal audio track, with the Pitch Adjust's Scale set to desired scale. The Correction Speed parameter is set to max value and the Preserve Expression parameter to minimum.
- **Octave dub**  
Neptune is used as a Send Effect. The Pitch Adjust section is turned off and the Transpose section is activated. The Semi parameter is set to +12 to transpose up 1 octave. The Send FX control on the mixer is used for balancing the level of the octave-shifted voice. The Formant Shift control is used for making the transposed voice sound more natural (or unnatural, if that's desired).
- **Create backing harmonies on a vocal track**  
Neptune is used as an Insert Effect on the vocal audio track and MIDI Input is routed to the Voice Synth via the Neptune sequencer track. Play some notes on your MIDI master keyboard and use the Voice Synth breakout jacks connected to a separate Mix Channel for further processing.
- **Pitch shift drums (non-pitched input)**  
The Pitch Adjust section is turned off and the Transpose section is activated. The Transpose parameters are set to desired values.
- **It is also possible to perform other tricks, as described in "Pitch adjustment tips and tricks".**

# Overview and basic concepts

## Sections overview



The Neptune panel is divided into three main sections that are connected in series:

- **The Pitch Adjust section.**  
Here is where you control the pitch correction settings, including scale, correction speed etc. Here is also where you find the big display where you can view Input Pitch, Target Note and Catch Zone etc. See [“Using pitch correction”](#). for more details.
- **The Transpose section.**  
Here is where you control the pitch shifting parameters. See [“Using pitch shifting \(Transpose\)”](#) for details.
- **The Formant section.**  
Here is where you can control and adjust formants. See [“Using Formant control”](#) for details.

These three main sections can be used separately, or in combinations, by clicking the ON/Off button of the respective section:



The first section in the signal chain is the Pitch Adjust section. To get a realistic result out of the pitch correction, you will probably want to use it in combination with the Formant section - especially if you control the target pitch via MIDI and the target pitch differs a lot from the input pitch.

The Transpose section can be used stand-alone when you only want to perform stiff pitch shifting of the input audio. If you want to pitch-shift atonal audio, you should use the Transpose section stand-alone, or in combination with the Formant section, for best result. You can also use the Transpose section together with the Pitch Adjust section for transposing pitch corrected audio by a defined amount.

The Formant section can be used stand-alone if you only want to change the character of the input audio - without affecting the pitch. Used on vocals or speech, the Shift knob lets you control the “gender” of the voice.

Besides these three main sections, there are also additional parameters for defining audio input characteristics (see [“Input signal type”](#)), MIDI control (see [“MIDI Input”](#)) and output level control (see [“The Output Mixer section”](#)).

## The display



The big display in the center of the Neptune panel shows the following information:

- **The Input Pitch of the incoming audio signal.**  
The detected Input Pitch is displayed as a yellow vertical line above the keyboard.
- **The Target Note to which Neptune corrects the output signal.**  
The Target Note is displayed as a green vertical line above selected notes on the keyboard.
- **An orange horizontal line between the Input Pitch and the Target Note.**  
The orange line shows the distance and direction from Input Pitch to Target Note.
- **The Catch Zones, i.e. the pitch “window” which determines to what Target Note to correct the Input Pitch.**  
The Catch Zones are displayed as red horizontal boxes above each selected key on the virtual keyboard. As soon as a detected Input Pitch lies within a Catch Zone, the Catch Zone box above the corresponding Target Note switches to green. See [“Setting Catch Zone Size”](#).
- **The virtual keyboard, where you can select your own notes or custom scale to correct the audio to.**  
See [“Setting Root Key and Scale”](#).

## Setting up for pitch processing

The examples below describe how to connect and use Neptune in typical pitch adjustment situations. We assume here that you have a MIDI keyboard connected, or use the On-screen Piano Keyboard (see [“On-screen Piano Keys”](#)).

### Setting up for pitch processing of recorded audio tracks

The most flexible method of performing pitch adjustments is to apply it to already recorded audio tracks in the sequencer. Doing so will give you total freedom to edit and change the pitch adjustment settings afterwards without needing to re-record any audio.

To set up Neptune for pitch adjustments of recorded audio tracks, proceed as follows:

1. **Select the Audio Track in the sequencer for the track you want to pitch-adjust.**
  2. **Create a Neptune device.**  
The Neptune device will be created as an insert effect in the Audio Track device and will be automatically connected to the appropriate connectors.
- **If you want to control the pitch adjustment via your MIDI keyboard, create a sequencer track for the Neptune device and select the Neptune track in the Track List.**

Now, you are all set for pitch adjustments of the audio on the Audio Track. For information about pitch correction, see [“Using pitch correction”](#), for information about pitch-shifting, see [“Using pitch shifting \(Transpose\)”](#), and for info about creating additional vocal harmonies, see [“Using the Voice Synth”](#).

## Setting up for pitch processing of “live” audio

Neptune can of course also be used for performing pitch adjustments in real-time. This is great for live performances and can also be used for recording pitch-processed audio on an audio track.

To set up Neptune for pitch adjustments in real-time, proceed as follows:

- 1. Create a Mix Channel device.**
- 2. Create a Neptune device, either by double clicking the Neptune device icon on the Device Palette in the Effects location in the Browser, or by selecting it from the Create menu.**

The Neptune device will be created and routed as an insert effect in the Mix Channel device.

- 3. Connect a microphone to your audio interface and manually patch the appropriate Audio in jack on the Reason Hardware Interface to the Left Input on the Mix Channel device.**

→ **If you want to control the pitch adjustment via your MIDI keyboard, create a sequencer track for the Neptune device and select the Neptune track in the Track List.**

→ **To make the tracking of the Input Pitch faster you could try and activate the “Live Mode” button.**

This will reduce the latency even further, but could in some situations make the pitch tracking a little unstable.

Now, you are all set for live pitch adjustments. For information about pitch correction, see [“Using pitch correction”](#), for information about pitch-shifting, see [“Using pitch shifting \(Transpose\)”](#), and for info about creating additional vocal harmonies, see [“Using the Voice Synth”](#).

If you want to record your processed audio on an audio track in the sequencer, perform the following additional steps:

- 4. Create an Audio Track.**
- 5. Click the Rec Source button on the Mix Channel device you use for the Neptune.**
- 6. Select the Mix Channel device as input source in the Input Selector on the Audio Track in the sequencer.**

This will route the pitch-processed audio from the Mix Channel to the Audio Track. This setup is identical to what you would use when recording with effects, as described in [“Creating an input channel for recording with effects”](#).

## Using pitch correction

Pitch correction is great if you, for example, have a vocal track in your song that contains flat notes. Instead of having to overdub the flat parts on the audio track, you can automatically adjust the pitches of the flat notes using Neptune. You can also sing through the Neptune in real-time and get a beautifully pitched voice!

There are two basic ways of using pitch correction in Neptune:

- **Automatic pitch correction using Scales, see [“Using automatic pitch correction”](#).**
- **Manual pitch correction using MIDI note input, see [“Using manual pitch correction”](#).**

You can also combine the two methods if you like. First of all, though, you will need to make some basic settings:

## Basic settings for pitch correction

Proceed as follows to set up the panel parameters for pitch correction:

1. Set up the Neptune device as desired according to the descriptions in **“Setting up for pitch processing”**.
2. Make sure the **“Pitch Adjust”** button is activated and that the **“Transpose”** button is off.



- **Whether the Formant button should be on or off depends on the situation.** For very small pitch corrections, you might want to leave this off; for more substantial pitch changes you will get the most natural sound when this is activated.
3. Define the Input signal type by using the **“Low Freq”**, **“Wide Vibrato”** and **“Live Mode”** buttons:



- **Activate “Low Freq” for low-frequency material such as a deep voice etc.** The “Low Freq” mode will make Neptune detect low frequency notes in a more precise way. Note that the latency will become longer due to the fact that low frequencies have longer cycle times.
- **If the input voice contains a lot of vibrato, it might be a good suggestion to activate the “Wide Vibrato” button.** If your input audio has a heavy vibrato, this can cause Neptune to detect the wrong pitches. The result can be wobbling notes, unwanted swoops and glides etc. Activating the Wide Vibrato button will make the pitch detection ignore any vibrato in the input audio, eliminating the problems. Note however that the vibrato can still be retained in the processed sound, by raising the Preserve Expression parameter (see **“About the Preserve Expression parameter”**).
- **If you are going to use pitch correction by singing through Neptune in real-time, try activating the “Live Mode” button.** This will reduce the latency of the pitch correction to a minimum, which might be preferable if you want to monitor the corrected signal as you sing. Note, however, that the audio quality may be lower in Live Mode.

#### 4. Make sure the "MIDI" button is set to "To Pitch Adjust".



This will enable the pitch correction to be controlled also via MIDI (see ["Using manual pitch correction"](#)).

## Using automatic pitch correction

With the Root and Scale functions you can define what notes you want the incoming audio to be corrected to. The input audio will then be automatically corrected to the defined scale, without further user interaction. With the Catch Zone, Correction Speed and Preserve Expression parameters you can set the character of the adjusted signal.

- It's also possible to manually override the automatic settings via MIDI at any time, see ["Using manual pitch correction"](#).

## About the Scale Memory

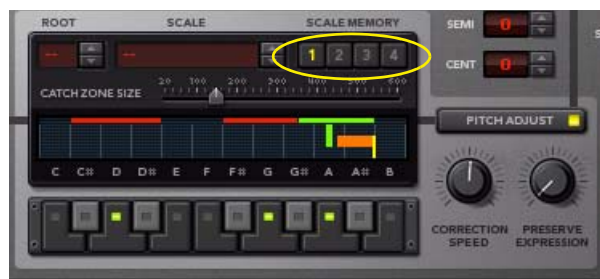

There are four Scale Memory slots in the Pitch Adjust section. The purpose of Scale Memories is to allow for automation of different Root Key, Scale and Catch Zone settings. A selected Scale Memory slot automatically stores which Root Key and Scale notes are active (see ["Setting Root Key and Scale"](#)), just like a Redrum stores what 16th note buttons are selected in a pattern. The Scale Memory slots also store Catch Zone settings (see ["Setting Catch Zone Size"](#)). By using automation of the Scale Memory slots from the Neptune sequencer track, you can easily switch characteristics throughout the song. The Scale Memory settings are automatically saved with the document when you save your Song.

- ! **Before you perform any edits of the Root Key, Scale and/or Catch Zone parameters, make sure you have selected a Scale Memory slot that you want to overwrite.**

## Setting Root Key and Scale

- ! **Any Root Key and/or Scale settings changes you make are automatically stored in the currently selected Scale Memory slot in real-time, see ["About the Scale Memory"](#).**

Define the Root Key and Scale parameters as follows:

**1. Set the Root Key with the Root spin controls.**

The key can be chosen between C and B in a one octave span, covering each key in the western 12-tone scale.



**2. Set desired scale with the Scale spin controls.**

The Scale parameter can be set to any of the following preset scales, as indicated in the Scale display:

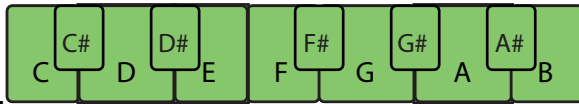

*Chromatic*



*Major with C as Root Key*

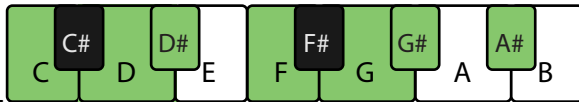

*Natural Minor with C as Root Key*

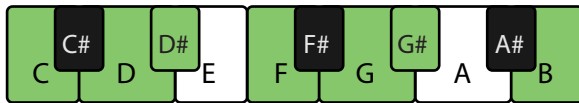

*Harmonic Minor with C as Root Key*

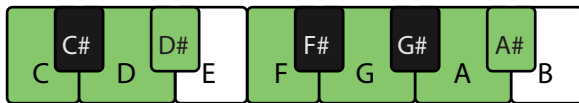

*Dorian with C as Root Key*



*Mixolydian with C as Root Key*

**! \* When Chromatic is selected, the Root display will switch to show "--" since all notes in the 12-tone scale are included and the root key is of no importance here.**



- You can also define your own custom scale by clicking on the keys in the display. Selected notes in your custom scale will be indicated with green LEDs:



A custom scale containing the notes D, G and A.

When you set your own scale both the Root Key and Scale displays will switch to show "--".

- The set Key and Scale is automatically repeated for every octave throughout the entire note range.
- ! Note that this doesn't necessarily need to be an actual scale - sometimes you may only need to activate one or two notes, passing the other notes through, uncorrected.

## Setting Catch Zone Size



The Catch Zone Size parameter defines what pitches in each octave should be "caught" and adjusted towards the closest Target Notes.

- ! Any Catch Zone Size settings changes you make are automatically stored in the currently selected Scale Memory slot in real-time, see "[About the Scale Memory](#)".

The Catch Zones are shown as boxes above each selected note in the keyboard display:

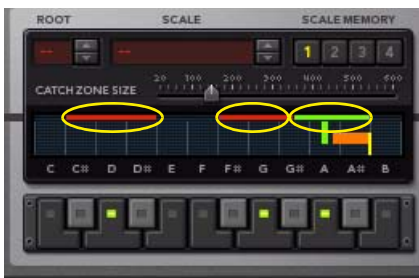

The Catch Zones for the notes in a custom scale with notes D, G and A selected.

- The Catch Zone size is set with the Catch Zone Size knob. The range is  $\pm 20$  to  $\pm 600$  cent, set in 20 cent steps. The range is always centered around the selected notes in the scale and the default value is  $\pm 100$  cents.
- ! Pitches outside or in-between Catch Zones are not caught and adjusted, but let through unprocessed.

- **Catch Zones cannot overlap each other. If the Catch Zone Size is increased so that adjacent zones touch each other, they will stop expanding in that direction and meet “half ways”.**

The Catch Zone size in the picture below is set to  $\pm 150$  cents. As you can see, the Catch Zones for notes G and A have “collided” and therefore met half ways in the center of the G# note. If the Catch Zone size should be increased further, the G Catch Zone would expand only downwards and the A Catch Zone only upwards.



*The Catch Zones for the selected notes D, G and A in a custom scale.*

- **If the Catch Zones should extend on either side of the 12-note keyboard range, they will “wrap around”.**

In the picture below, notes C and G are selected in a custom scale. The Catch Zone Size is set to  $\pm 250$  cents. Since the Catch Zone for the C note extends also to the left outside the display, the Catch Zone “wraps around” visually and continues from the B note down to the A# note. Since the Scale is repeated downwards and upwards for every octave, the result of this setting is that the Catch Zone for the C note will cover the B and A# notes in every octave.



*The Catch Zones for the selected notes C and G in a custom scale, with the C note Catch Zone “wrapped around” to cover also notes B and A#.*

## Setting Correction Speed



The Correction Speed parameter controls how fast the Input Pitch should be adjusted to the Target Note. The range is from Slow (knob turned fully counter-clockwise) to Fast (knob turned fully clock-wise).

- **For a natural, transparent correction, a setting around the 12 o’clock position is ideal in most situations.**
- **A very fast correction speed will create almost a “stepped” correction.**  
This is the setting of choice for creating the infamous “robot voice” effect known from numerous radio hits.
- **A slow correction speed will make the pitch correction almost unnoticeable during fast passages in the music.**  
This is because the correction won’t have time to set in before new incoming pitches are detected.

## About the Preserve Expression parameter



The Preserve Expression parameter controls how much vibrato in the input audio should be let through when you use a fast Correction Speed setting (see [“Setting Correction Speed”](#)).

- **With a minimum Preserve Expression value and a fast Correction Speed there will be almost no natural vibrato left in the pitch corrected voice.**
- **With max Preserve Expression value and a fast Correction Speed the original vibrato is still preserved.**
- **With max Preserve Expression value and a slow Correction Speed the original audio is let through almost unaffected.**

## About adding Pitch Bend and Vibrato

It's also possible to add Pitch Bend and/or Vibrato via MIDI while using the automatic pitch correction:

- **Select “To Pitch Adjust” in the MIDI Input section.**



This allows for incoming MIDI Pitch Bend and Vibrato (Mod Wheel) data to control the output pitch and to add vibrato to the output signal.

- **Clicking and moving the wheels on the panel will also generate pitch bend and vibrato.**

## Using manual pitch correction

It's possible to override the automatic (scale) pitch correction settings with monophonic MIDI note data at any time. This makes it possible to control the desired output pitches either by playing live on a MIDI master keyboard - or by playing back recorded MIDI notes from the Neptune track in the sequencer!

- 1. Create a sequencer track for the Neptune device and select the Neptune track in the Track list.**
- 2. To allow for MIDI note control of pitch correction, select “To Pitch Adjust” in the MIDI Input section:**



- **When you sing through Neptune and hold down a key on your MIDI master keyboard, the output pitch will correspond to the held MIDI note.**

As soon as any MIDI note is received by Neptune, the Root Key, Scale and Catch Zone settings will be temporarily ignored. However, the Correction Speed (see [“Setting Correction Speed”](#)) and Preserve Expression parameters (see [“About the Preserve Expression parameter”](#)) will still be active.

- ! **Note that MIDI control of the pitch is monophonic.**
- **When pitch correction is controlled via MIDI, the corrected audio signal will also respond to Pitch Bend and Vibrato modulation.**
- ! **If you transpose pitches several semitones compared to the input pitch, there could be strange formant effects that may or may not be desirable. To make heavily pitched signals sound more natural, you can use the formant correction function described in “Using Formant control”.**
- ! **Note that MIDI control of the pitch correction will only momentarily override the Root Key, Scale and Catch Zone settings. As soon as there is no MIDI Note present, the automatic (scale) pitch correction settings will take over again.**
- **It’s also possible to generate polyphonic voices (harmonies) via MIDI using the Voice Synth function, see “Using the Voice Synth”.**

## Using pitch shifting (Transpose)

Pitch shifting basically means altering the pitch of the input audio by a set factor - the transpose value - and output the result. As opposed to pitch correction, pitch shifting can be made on any type of monophonic audio input signal; it doesn't even have to have a regular pitch (tone). Pitch shifting can be used to generate a number of cool effects, for example:

- **Voice doubling effects by using slight transposition of only 5-10 cents.**
- **Adding an additional voice one octave up or down from the original lead vocal.**
- **Creating dark spooky monster voices by transposing speech down heavily.**
- **Creating chipmunk effects by transposing speech up heavily.**

The list goes on...

Use the Transpose function as follows:

1. **Click the Transpose button to activate the Transpose section.**



2. **Adjust the transposition using the Semi and Cent spin controls in the Transpose section.**

The Transpose range is  $\pm 12$  semitones with a fine tuning range of  $\pm 50$  cents.

- **If you want to transpose pitch corrected signals, make sure the Pitch Adjust section is on and has the desired parameter settings.**
- **If you want to transpose non-pitched signals, such as speech, switch off the Pitch Adjust section.**

# Using Formant control

## What are formants?

Formants can be described as a sonic “footprint” of an acoustic space. The practical effect of formants could be compared to a multi-peak filter acting on the frequencies in a sound. An acoustic guitar, for example, has a body shape which makes its sound the way it does. The same goes for a human vocal tract (throat and mouth cavity); every human vocal tract has a unique “shape” which gives the voice its character. It is these shapes that produce formants. A big difference between a vocal tract and a guitar body, though, is that the vocal tract changes shape as you sing different vowels. This also means that the formants will change.

When you pitch shift a signal up or down, the formant “multi-peak filter” will move up or down with the signal frequency (just like a traditional synthesizer filter would with full keyboard tracking activated). The result will be a signal that not only is pitched but also changes character. In some situations this might be what you want, but when it comes to pitch shifting vocals you will probably often want the pitch-shifted signal to sound like it’s sung by the same person. Therefore, Neptune features a formant control function.

The Formant section in Neptune lets you control the formants so they don’t move along with the pitched signals. Neptune continuously samples and analyses the input audio and determines both the pitch and the current formants of the signal in real-time. The formants are then automatically applied to the pitch-adjusted output signal in real-time.

The picture below shows schematic examples of a 500 Hz signal, pitch-shifted down and up one octave respectively, without and with formant correction. The formants are the peaks of the gray dotted lines in the graphs:

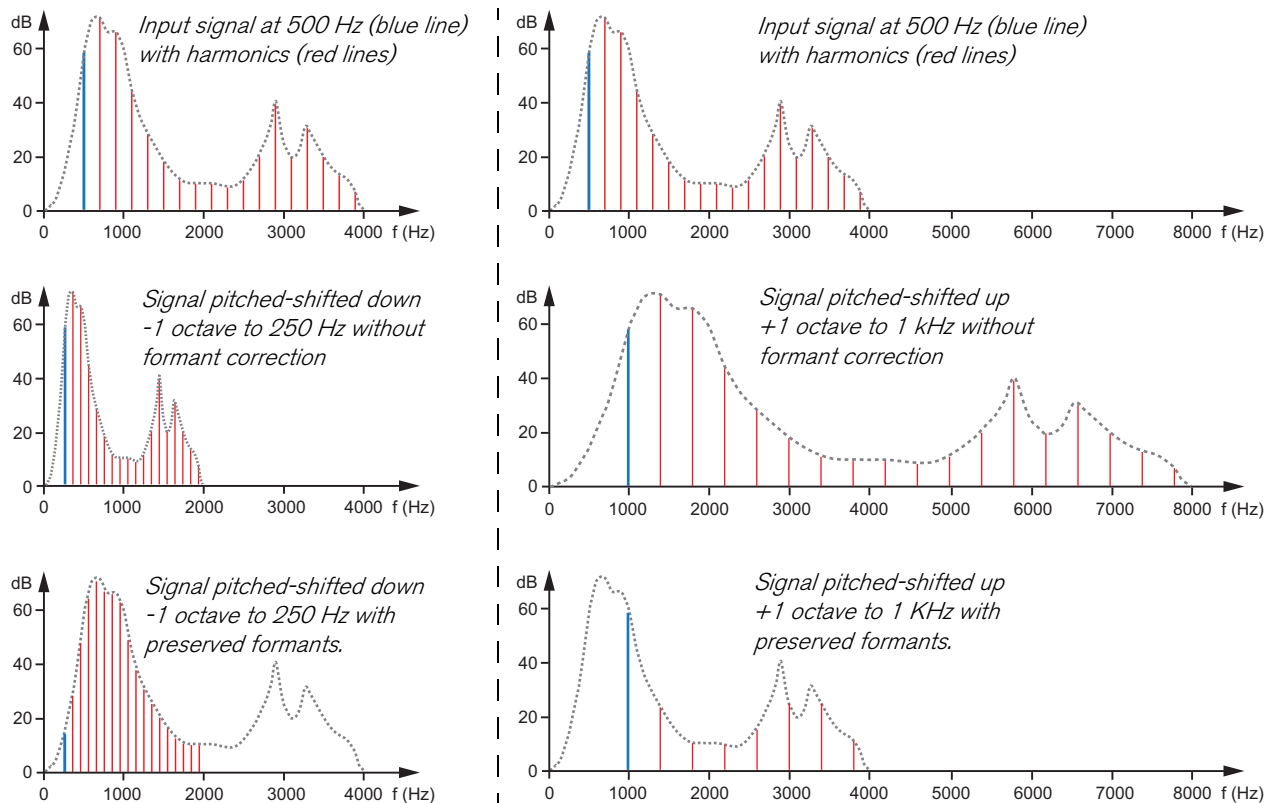

Pitch-shifting without and with formant correction applied. The left column shows -1 octave pitch-shifting and the right column +1 octave.

## Using the Formant function

When the Formant section is not active, the formants will move along with the pitched signal. On vocals this could generate unnatural “gender change” effects, especially on heavily pitched voices. If this is not the desired effect, you should activate the Formant section:

1. **Activate the Formant function by clicking the Formant button.**



2. **Adjust the Formant shift with the Shift knob.**

The Shift range is  $\pm 1$  octave.

- **The default 12 o'clock position means that the formants will be “locked” to the input signal and won't move with the shifted pitches.**  
Used on vocals this will give the impression of the same person singing at the adjusted pitches. (Refer to the picture in the “What are formants?” section for graphical examples of this particular Shift setting.)
  - **Turned further counter-clockwise, the formants will be “locked” to the input signal and displaced downwards relative to the input signal.**  
Used on vocals this will give the impression of a more deep male character voice.
  - **Turned further clockwise, the formants will be “locked” to the input signal and displaced upwards relative to the input signal.**  
Used on vocals this will give the impression of a more soprano/female/child character voice.
- ! **Note that Voice Synth has its own separate “built-in” formant correction and is not affected by the Formant section settings.**

## Using the Voice Synth

The Voice Synth function lets you use Neptune as a harmony processor to generate polyphonic voices out of a monophonic input signal. The application is similar to how you would use a vocoder, such as the BV512 Vocoder, for example. However, using the Voice Synth in Neptune will produce completely transparent and natural sounding harmonies with pitches controlled from MIDI Note data.

1. **Create a sequencer track for the Neptune device and select the Neptune track in the Track list.**
2. **Click the MIDI radio button to select “To Voice Synth” in the “MIDI” section. Also make sure the Voice Synth volume slider is raised:**



- **When you sing through Neptune and hold down a note or a chord on your MIDI master keyboard, the output pitch(es) will correspond to the held MIDI note(s).**
  - **The Voice Synth harmonies will also respond to any Pitch Bend and Vibrato modulation.**
- ! **The parameters in the Pitch Adjust, Transpose and Formant sections are ignored by the Voice Synth.**
- **You can mix Pitched Signal with the Voice Synth signal in the Mixer section. If you only want the Voice Synth sound, lower the Pitched Signal fader.**

# Panel parameters

On the front panel of Neptune, you will find the following parameters and displays:

## Level Meter and Bypass/On/Off switch



Parameter	Description
Bypass/On/Off switch	In Bypass mode, the input signal passes through unaffected to the main outputs of the device. The separate Voice Synth outputs are automatically muted. In On mode, the device outputs the processed signal. If the Voice Synth is used, its output signal are routed to the separate Voice Synth outputs. Off mode mutes the inputs, silencing the device.
Level meter	Shows the input signal level.

## Bend and Vibrato wheels

! Choose what the Bend and Vibrato wheels should control by selecting desired destination in the MIDI Input section - see **"MIDI Input"**.



- **The Pitch Bend wheel is used for bending the pitch of notes, much like bending the strings on a guitar or other string instrument.**
- **The Vibrato wheel can be used for applying vibrato to pitch corrected signals or to the Voice Synth harmonies.**

Most MIDI keyboards have Pitch Bend and Modulation controls. Use these to control pitch bend and vibrato, or use the wheel controls on the panel by clicking and moving the mouse.

### Bend Range

The Range parameter sets the maximum amount of pitch bend, i.e. how much it is possible to change the pitch by turning the wheel fully up or down. The maximum range is  $\pm 12$  semitones ( $\pm 1$  octave). You change the value by clicking the spin controls above of the display.

### Vibrato Rate

Use the Rate knob to set the rate of the vibrato controlled by the Vibrato wheel.

## Input signal type



Here, you define the characteristics of the input signals you use.

### Low Freq

Activating Low Freq mode will ensure more accurate tracking of low-frequency audio signals, such as bass voices. Low Freq mode is suitable for input frequencies below the note F1, which is approximately 44 Hz. The detection in Low Freq mode will work down to approximately 22 Hz which corresponds to note F0.

**! Note that the pitch detection latency will be somewhat longer in Low Freq mode due to the longer cycles times of low frequency signals.**

### Wide Vibrato

If your input audio has a heavy vibrato, this can cause Neptune to detect the wrong pitches. The result can be wobbling notes, unwanted swoops and glides etc. Activating the Wide Vibrato button will make the pitch detection ignore any vibrato in the input audio, eliminating the problems.

Note however that the vibrato can still be retained in the processed sound, by raising the Preserve Expression parameter (see [“About the Preserve Expression parameter”](#)).

### Live Mode

This is an ultra-fast tracking mode, perfect for when you want to monitor your pitch adjusted signal in real-time. However, we recommend that you turn this off when it's time to play back and mix your recordings, for the highest audio quality.

## MIDI Input



The MIDI Input section features a radio button which allows you to route incoming MIDI to either of the following destinations:

### Pitch Adjust

Routes incoming MIDI Note data to the Pitch Adjust section for manual control of pitch correction, see [“Using manual pitch correction”](#). Pitch Bend and Vibrato (Mod Wheel) MIDI data will also be routed to the Pitch Adjust section.



## Voice Synth

Routes incoming MIDI Note data to the Voice Synth for generating additional harmony voices, see [“Using the Voice Synth”](#). Pitch Bend and Vibrato (Mod Wheel) MIDI data will also be routed to the Voice Synth.

## Pitch Adjust section



### Pitch Adjust section On/Off

Click the Pitch Adjust button to activate/deactivate the Pitch Adjust section.

### Root, Scale and Keyboard

Set the Root key and Scale with the spin controls. You can also create your own custom scales by selecting individual notes in the Keyboard display. See [“Setting Root Key and Scale”](#) for more details on how to use these functions.

### Scale Memory

The purpose of Scale Memories is to allow for automation of different Root Key, Scale and Catch Zone settings. A selected Scale Memory slot automatically stores which Root Key and Scale notes are active. The Scale Memory slots also store Catch Zone settings.

The edits you make of the Root, Scale and Catch Zone parameters are automatically stored in the selected Scale Memory slot. The settings of the Scale Memory are saved together with the rest of the Song data. Refer to [“About the Scale Memory”](#) for details on how to use the Scale Memory slots.

### Catch Zone Size

With the Catch Zone Size slider you set the range of the input pitches to be corrected to specific notes. Refer to [“Setting Catch Zone Size”](#) for details on how to use this function.

### Correction Speed

Set the time it should take to adjust the pitch to the set scale. See [“Setting Correction Speed”](#) for more details.

### Preserve Expression

Set how much vibrato in the input audio should be let through when you use a fast Correction Speed setting. See [“About the Preserve Expression parameter”](#) for more details.

## Transpose section



Click the Transpose button to activate the Transpose section. When active, the output pitch will be transposed according to the settings of the Semi and Cent parameters. The Transpose function can be used either on pitch corrected signals (with the Pitch Adjust section active) or on non pitch corrected signals (with the Pitch Adjust section deactivated).

### Semi and Cent

Set desired transposition value, in semitones and cents, with the spin controls. The range is  $\pm 12$  semitones and  $\pm 50$  cents.

See [“Using pitch shifting \(Transpose\)”](#) for more details.

## Formant section



Click the Formant button to activate the formant control function. When active, the formants of the input signal will be preserved and won't move with the adjusted output pitches.

**! The Formant section settings have effect on the Pitch Adjust section and on the Transpose section, if they are active. However, the Formant section can also be used stand-alone to only displace the formants of the input signal.**

### Shift

Use the Shift knob to displace the formants within an range of  $\pm 1$  octave.

See [“What are formants?”](#) and [“Using the Formant function”](#) for more details.

## The Output Mixer section



The Pitch Adjust and Voice Synth parameters control the output from the Neptune in the following way:

## Pitched Signal

This slider controls the total output volume of the Pitch Adjust, Transpose and Formant sections routed to the Left and Right outputs (see “Audio Out”).

## Voice Synth

This slider controls the output volume of the Voice Synth routed either to the main Left and Right outputs or to the separate Voice Synth Left and Right outputs if these are connected (see “Voice Synth Out”).

**! Note that the Voice Synth function must be activated, otherwise this control will have no effect - see “Using the Voice Synth”.**

## Connections

Flipping the Neptune around reveals an array of connection possibilities. Some of these are CV (control signal) related and some are audio signal related.



## Sequencer Control

### Note

The Note input allows you to control the pitch of either the Pitch Adjust or Voice Synth (depending on what is currently selected in the MIDI Input section - see “MIDI Input”). The pitch could be controlled from a Note CV output of a Matrix or an RPG-8, for example.

**! A Gate signal on the Gate input (see below) must also be present for the Note Input to work.**

### Gate

The Gate input should be used in combination with the Note modulation input (see above). As soon as a gate signal is present, any note modulation on the Note input will be activated. The Gate could be controlled from a Gate CV output of a Matrix or an RPG-8, for example.

## CV In

These control voltage (CV) inputs can be used for modulating various Neptune parameters from other devices. The inputs control the following parameters:

## Bend

The Pitch Bend input allows you to control pitch bend of either the Pitch Adjust or Voice Synth (depending on what is currently selected in the MIDI Input section - see ["MIDI Input"](#)). The pitch bend could be controlled from a Pitch Bend CV output of an RPG-8, for example.

## Vibrato

The Mod Wheel input allows you to control the Vibrato amount of either the Pitch Adjust section or Voice Synth (depending on what is currently selected in the MIDI Input section - see ["MIDI Input"](#)). The Vibrato could be controlled from a Mod Wheel CV output of an RPG-8, for example.

## Formant

The Formant Shift input allows you to control the Shift parameter in the Formant section from a CV source on another device. The Formant Shift parameter accepts bipolar control signals (-63 to +64).

## CV Out

These control voltage (CV) outputs can be used for modulating other device parameters from Neptune:

### Pitch

The Pitch output allows you to control the pitch of other devices from the Pitch Adjust section, either directly or via the Transpose section (depending on if Transpose is active or not). The Pitch CV corresponds to the pitch of the pitch adjusted and transposed signal. The Pitch output could be connected to the OSC Pitch CV input of another synth device, for example.

### Amplitude

Neptune features an internal envelope follower. The Amplitude output sends out a control signal from this envelope follower based on the audio input level to Neptune. The Amplitude output could be connected to the Master Volume or Level CV input of a synth device, for example.

## Audio In

Route your audio input signal(s) to the Left (and Right) audio input(s) to the right on the rear panel.

**! If you want to use Neptune in mono, connect only to the Left input.**

## Voice Synth Out

Connect to these outputs if you want to break out the audio from the Voice Synth as separate signals and, for example, route to a separate Mix Channel for separate processing.

**! When these are connected, the Voice Synth audio will be removed from the main Audio Out outputs.**

## Audio Out

The Left and Right outputs are the main stereo outputs of Neptune. Here, the audio from the Pitch Adjust, Transpose and Formant sections are routed. If the Voice Synth Sep Output (see ["Voice Synth Out"](#)) are not connected, the Voice Synth audio output are also routed to the main outputs.

**! If you want to use Neptune in mono, connect only to the Left output.**

# Pitch adjustment tips and tricks

With Neptune you can use the pitch adjustment effects separately or in various combinations to generate different types of pitch effects. In this section a number of useful setups are described.

## Using automation for temporary pitch correction

To get the most natural-sounding results from Neptune you can use automation in the sequencer to momentarily apply pitch correction only where it's necessary on the audio track. The example below shows a lead vocal track which sounds great most of the time, but has a few flat passages that we want to correct.

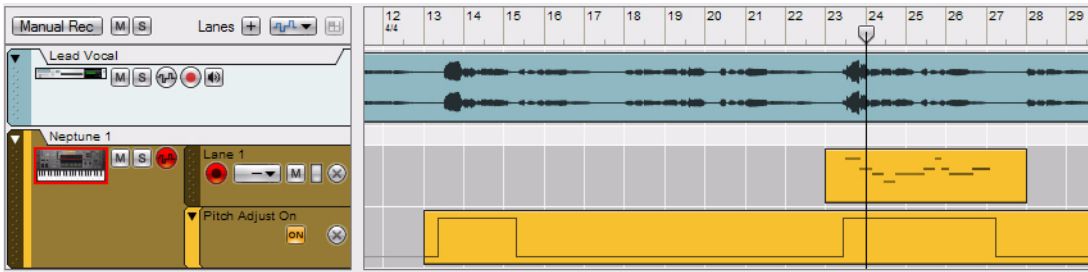

### 1. Use Neptune as an Insert Effect on the lead vocal track.

Between the middle of bar 13 and bar 15 there are a couple of flat notes that need to be corrected slightly. Between the middle of bar 23 and bar 27 there are some notes that we want to change several semitones.

### 2. Create a sequencer track for the Neptune device.

### 3. Set the Pitch Adjust button parameter to “Off” and create an automation lane for the parameter.

This will allow you to switch on and off pitch correction automatically.

### 4. Set the desired Scale or click the notes you want to use on the virtual keyboard.

### 5. Adjust the Correction Speed and Preserve Expression parameters to values that will make the pitch correction sound natural.

### 6. Activate the Formant section so that any adjusted pitches will have the original formants preserved.

### 7. Create an automation clip and change the Pitch Adjust button parameter to “On” between the middle of bar 13 and 15.

This will switch on pitch correction only in these bars.

In bar 23-27 we want to change some pitches several semitones. We can't use the automatic pitch correction here because this would correct the pitches to the closest notes in our scale and that is not what we want here. We could create a new custom scale in another Scale Memory slot and use here, but the easiest would be to just override our scale with MIDI notes.

### 8. Change the Pitch Adjust parameter to “On” in bars 23-27.

This will switch on pitch correction again in these bars.

### 9. Next, make sure that the MIDI Input in Neptune is set to “Pitch Adjust”.

This ensures that any incoming MIDI notes will control the Pitch Adjust section (and not the Voice Synth).

### 10. Place the sequencer Song Position Pointer at bar 23 and start recording on the Neptune note lane.

Record the new notes from your MIDI master keyboard at bar 23 through bar 26.

Now, pitch correction has been applied only where necessary on the audio track. In bar 13-15 pitch correction was automatically applied using a defined scale, and in bar 23-27 the automatic pitch correction was overridden by MIDI notes.

- If you like, you could freeze your pitch processed track with the effects - see [“About “freezing” pitch adjustments on audio tracks”](#).

## Hard pitch correction of a vocal track

1. Use Neptune as an Insert Effect on the vocal audio track.
  2. Use a suitable scale setting and set the Correction Speed parameter to max and Preserve Expression to minimum in the Pitch Adjust section.  
If needed, adjust the Scale to fit the song key. If necessary, override certain passages manually with MIDI (see [“Using automation for temporary pitch correction”](#) above for a practical example).
- If you want to control the pitch adjustment via your MIDI keyboard, create a sequencer track for the Neptune device and select the Neptune track in the Track List.
  - If you like, you could freeze your pitch processed track with the effects - see [“About “freezing” pitch adjustments on audio tracks”](#).

## Pitch correction with changed voice character

If you want to pitch-correct your lead vocal but make it sound like another person is singing, you can easily do that:

1. Set up the Pitch Adjust section for automatic pitch correction as desired (see [“Using automatic pitch correction”](#)).
2. Activate the Formant section.
3. Adjust the Shift parameter up or down to change the voice character of the output.  
Adjust down to generate a deeper (male) character and up to create a more soprano-like female character.

## Octave dub

1. Use Neptune as a Send Effect in the Main Mixer Master Section.
  2. Turn off the Pitch Adjust section and activate the Transpose section.
  3. Set the Semi parameter to +12 to transpose up 1 octave.
  4. Play back, or input audio in real-time on your mixer channel.
  5. Use the Send FX control on the mixer channel strip to balance the level of the octave-shifted voice.
- Use the Formant Shift control to make the transposed voice sound more natural (or unnatural, if that's what you want).

## Pitch-shifting drums (non-pitched input)

1. Route the drum sound to the audio input(s) of Neptune.
  2. Turn off the Pitch Adjust section and activate the Transpose section.
  3. Set Semi and Cent parameters to desired values.
- Use the Pitch Bend control for special bend effects.
  - Activate the Formant section and experiment by shifting the formants if you like.

## Speech effects

To create various types of atonal speech effects you can use the Transpose section, alone or together with the Formant section:

- 1. Make sure the Pitch Adjust section is deactivated (off).**
  - 2. Activate the Transpose section.**
  - 3. Set desired transposition ratio with the Semi and Cent spin controls in the Transpose section.**  
Adjust down to generate a darker voice and up to create a brighter voice.
- **To lock the formants and thus preserve more of your voice's original character, activate the Formant section and set the Shift parameter to the 12 o'clock position.**  
To change the voice character, adjust the Shift parameter down to generate a bassier (male) character and up to create a more soprano-like female character.
  - **Experiment with different combinations of Transpose values and Formant Shift values to create different "characters".**

## About "freezing" pitch adjustments on audio tracks

In all examples below that describe pitch adjustments of recorded audio tracks, you can choose to "freeze" the tracks afterwards. By using the Bounce Mixer Channels function you can have your pitch processed audio track rendered to a new track in the sequencer, complete with pitch adjustment effects and all. Just be sure to use the following settings in the "Bounce Mixer Channels" dialog:

- **Range to Bounce: "Song" (to get the entire track rendered, if that's what you want)**
- **Bounce to: "New Tracks in Song"**
- **Apply Mixer Settings: "All" or "All except fader section" (to include the pitch adjustment effects)**

Refer to "[Bouncing Mixer Channels](#)" for more details.





# **Chapter 47**

## **Half-Rack Effects**

# Common effect device features

While the specific parameters for each effect device are described below, some features and procedures are common to all effect devices:

## The Input meter

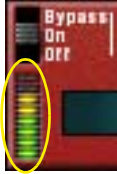

This shows the level of the incoming audio signal, giving you an indication of which devices are active, connected and playing. However, you don't need to worry about clipping in effect devices, even if the meter goes into the red.

## The Power/Bypass switch

This is located in the upper left corner of each effect device. The switch has three modes, according to the following figure:

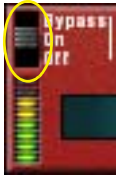

Mode	Description
Bypass	In this mode, the input signal is passed directly to the audio output, without being affected by the effect device. This is useful when the effect device is connected as an insert effect, and you want to compare the effect sound with the dry sound.
On	This is the default mode, in which the device processes the incoming signal.
Off	In this mode, the effect device is turned off and neither dry nor effect sound is sent out. This is useful when the device is connected as a send effect and you want to turn it off temporarily.

## About making settings

You adjust effect parameters using the regular editing techniques.

- **A quick way to reset the parameters to their default values is to hold down [Ctrl](Win) or [Cmd](Mac) and click the corresponding knob.**

## About Connections

- **All effect devices have stereo inputs and outputs, and can be connected as send effects or as insert effects.** However, some effects are best used as one of these only. This is stated for each effect on the following pages. See also the section about the signal flow graphs below.
- **Most of the effect devices have one or several CV inputs on the back panel.** These allow you to control various effect parameters in real-time, from another device in the rack. See "[Routing CV and Gate signals](#)" for details about routing CV.

## The Signal Flow graphs



On the back of each effect device, you will find two or three small “graphs”. These indicate how the effect device handles mono and stereo signals, depending on the connections. The selection of graphs for a device tells you how it should be used, according to the following rules:

Graph	Description
	Can be connected as a mono-in, mono-out device. (Of course, all effect devices <i>can</i> be connected in mono. However, if this graph isn't shown for a device, this means that a mono-in, mono-out connection may not give the proper results).
	Can be connected as a mono-in, stereo-out device. This means that the device creates some sort of stereo effect (e.g. a reverb) or a mono effect that can be panned.
	If you connect both inputs and outputs in stereo, the two sides will be processed independently (dual mono processing).
	If you connect both inputs and outputs in stereo, the two sides are summed before the effect processing. However, the actual effect is in stereo (and the dry signal will remain in stereo, if it is passed through the effect).
	“True stereo” processing, or “stereo in - stereo out” processing. When you connect the inputs in stereo, each channel in the effect uses the signal information from both inputs. However, the inputs are not summed - the two channels are processed differently. This mode is available on the RV7000 Advanced Reverb - see <a href="#">“RV7000 Mk II Advanced Reverb”</a> .

# DDL-1 Digital Delay Line



This is a mono delay (where the output can be panned in stereo) that can be synchronized to the song tempo. The delay can be used as a send effect or an insert effect.

## Parameters

Parameter	Description
Delay time	The display to the left on the device panel shows the delay time, either as note value steps (based on the sequencer tempo and the Step Length parameter) or in milliseconds, depending on the setting of the Unit switch. The maximum delay time is two seconds (2000 ms) while the maximum number of steps is 16. Note that if the tempo is low, you may reach the maximum delay time at a lower number of steps than 16 (in which case raising the steps value will not make any difference).
Unit	This is where you select whether you want a tempo-based delay ("Steps" mode) or a free time delay ("MS" mode). In the Steps mode, you specify the delay time in note value-based steps. This means that if you change the tempo in the transport panel, the delay will maintain its rhythmic relation to the music (provided that the resulting delay time doesn't reach the maximum value). This mode is useful for creating rhythmic patterns. If you change the tempo when using the delay in MS mode, the delay time will remain the same. See also the note about switching Unit modes below.
Step length	Governs whether each step in Steps mode should be a sixteenth note (1/16) or an eighth triplet note (1/8T).
Feedback	Determines the number of delay repeats.
Pan	Pans the delay effect to the left or to the right.
Wet/Dry	If you are using the delay as an insert effect, you use this parameter to adjust the balance between the unprocessed audio signal (dry) and the delay effect (wet). If the delay is used as a send effect, this should be set all the way to wet only, since you can control the balance by using the AUX send controls in the Mixer.

## CV Inputs

The following CV inputs are available on the back panel of the device:

### → Pan CV.

This allows you to control the panning of the delay signal. Connect an LFO to this for moving delay effects, or use a Matrix pattern to simulate random delay panning.

### → Feedback CV.

This allows you to control the amount of feedback (the number of delay repeats) from another device. Useful for dub-type echoes on certain beats or notes only.

## Switching between Unit modes

When you switch between the two Unit modes (Steps and MS), the following rules apply:

### → If you switch from Steps mode to MS mode, the delay will be set to the same actual delay time as was used in the Steps mode.

This means that you can set up an exact rhythmic delay in Steps mode, and then switch to MS mode to adjust it slightly.

### → If you switch from MS mode to Steps mode, the delay is reset to the previously used Steps value.

# CF-101 Chorus/Flanger



The CF-101 is a combined chorus and flanger effect. It adds depth and movement to the sound by adding a short modulated delay to the audio signal. The delayed signal is then mixed with the original (either in the effect device or manually by you - see below). The CF-101 can be used as an insert or send effect.

## Parameters

Parameter	Description
Delay	This is a manual control for the delay time used to create the chorus/flanger effect. Usually, flanger-type effects use fairly short delay times while chorus-type effects use medium long delays.
Feedback	This governs the amount of effect signal fed back to the input, which in turn affects the intensity and character of the effect. Turning this to the extreme left (negative feedback) or right (positive feedback) produces different flanger effects with a pronounced resonance “tone”, while keeping it in between produces a more gentle chorus effect.
LFO Rate	This is the frequency of the LFO modulating the delay time. The higher the value, the faster the sound will oscillate.
LFO Sync	This button lets you activate/deactivate LFO sync. When it is activated, the frequency of the LFO is synchronized to the song tempo, in one of 16 possible time divisions. The LFO Rate knob is then used for setting the desired time division. Turn the knob and check the tooltip for an indication of the time division.
LFO Mod Amount	This determines the depth of the LFO modulation, i.e. by how much the delay time should be modulated. If you set this to 0, the effect will be “frozen” (most effective if you add some feedback).
Send Mode	This determines whether the delayed signal and the dry signal should be mixed in the effect device or not. If you use CF-101 as an insert effect, you should turn this off - the device will then output a mix of the dry signal and the modulated delay signal. If you use the device as a send effect, you should activate Send mode. Then, the device will only output the modulated delay signal, allowing you to mix it with the dry signal using the AUX send controls in the mixer. See also the note below about using the CF-101 as a vibrato effect!

## CV Inputs

The following CV inputs are available on the back panel of the device:

### → Delay CV.

Allows you to control the delay time from another device. This may give best results if you turn off the LFO modulation in the device (turn LFO Mod Amount to zero). For example, by controlling the delay parameter from a Matrix, you can create “stepped flanger” effects, in sync with the tempo.

### → If you use the Delay CV input for “playing” the feedback tone, note that a higher delay value gives a lower pitch.

### → Rate CV.

Lets you control the rate of the modulating LFO from another device.

## About Stereo and Mono connections

The CF-101 can be connected using mono or stereo inputs, as shown by the graphs on the back panel. Note the following:

### → A “moving” stereo effect is only obtained when you use a mono input and stereo outputs.

With a stereo input, the two sides are processed in parallel, maintaining the stereo image of the original sound.

→ **When you are using a mono input and stereo outputs, there will only be a stereo effect if the internal LFO is used.**

If you turn LFO Mod Amount to zero, both stereo outputs will carry the same signal (mono). This is because the “fake stereo” effect is produced by inverting the modulation for one of the output channels.

### **Tip: Using the CF-101 as a vibrato effect**

The Send mode is intended for when using the CF-101 as a send effect. In this mode, the device will only output the modulated delay signal - you get the actual “chorusing” by mixing this signal with the dry, unprocessed signal in the Mixer.

However, if you activate Send mode while using the device as an insert effect, the result will be a pitch modulated version of the original sound - in short, a vibrato effect. Along with a little feedback, this can be used for special effects.

# Spider Audio Merger & Splitter



The Spider Audio Merger & Splitter is not an effect device, but a utility. It has two basic functions:

- **To merge up to four audio input signals into one output.**
- **To split one audio input signal into four outputs.**

There are no controls on the front panel of this device, only signal indicators.

## Merging audio



**Four audio input pairs** — **Merged signal outputs**

On the back panel of the Spider are several audio connectors. The left half of the panel contains four stereo audio input connectors, and to the right of these, one merged stereo output.

- **The principle is simple; all audio signals connected to any of the four inputs will be merged and output via the output connectors.**

If you connect a mono signal (to a L/Mono input, with nothing connected to the corresponding R input) it will be output on both merged outputs. This way you can merge stereo and mono signals freely.

If you connect a signal to the R input only (with nothing connected to the corresponding L/Mono input) it will be output on the R output only.

## Practical uses of merging audio

There are many practical uses of merging audio signals together, for example:

- **Process several audio signals with the same insert effect(s).**  
Perhaps you want to process certain channels in a mix with the same compressor, or use one ECF-42 to filter a group of instruments in a mix. You can also set up a chain of insert effects and process the merged signals.
- **Sub-grouping signals.**  
It may be practical to control several audio signals using one channel strip in the Mixer.
- **Use merged signals as either carrier or modulator source for the BV512 Vocoder.**  
You could use several sounds as carrier signal, or modulate the carrier with several signal sources.

## Splitting audio

The right half of the back panel contains two signal splitters, labeled “A (L)” and “B (R)”. The two splitters work independently, in the following way:

- **The signal fed to the input connector will be simultaneously output by all four outputs.**

For splitting stereo signals you simply use both splitters with “A” for the left channel and “B” for the right channel.



Audio inputs

Four split output pairs

## Practical uses of splitting audio

There are many practical uses of splitting audio signals - here a few examples:

- **Create “pseudo” stereo effects from mono signals.**

For example, you could route the mono output of a Subtractor to the Spider and then send two split outputs (from the same row) to different effects and on to different Mixer channels panned left and right.

- **It provides a way to instantly switch between (or mix) different variations of the same signal.**

This is a neat way of applying “spot effects” in a mix. An instrument output is split and sent to three different combinations of insert effect processing. The outputs from the three effects are routed to separate channels in the Mixer, which could in turn have different send effects, eq, etc. You then have three different variations of the same signal that can be easily switched in and out of the mix for drastic sonic changes - or combined for huge layered sounds.



# Spider CV Merger & Splitter



The Spider CV Merger & Splitter is not an effect device, but a utility. It has two basic functions:

- **To provide one merged CV output from up to four CV input sources.**
- **To split CV or Gate inputs into several outputs.**

Two inputs, A and B, are provided, each with four outputs, where one of the outputs will invert the polarity of the control signal. One reason for having two splittable inputs is to make it possible to split Gate and Note CV, to control several instrument devices with one Matrix for example.

There are no controls on the front panel of this device, only CV signal indicators. The four horizontal indicators light up to indicate signals connected to the corresponding merge input. The two indicators to the right indicate signals connected to the corresponding split inputs.

## Merging CV

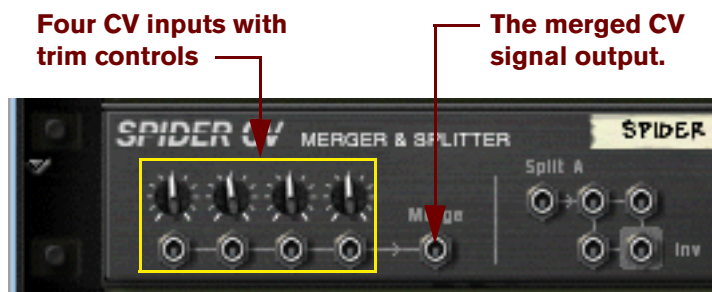

On the back panel of the Spider there are several CV connectors. The left half of the panel contains four CV/Gate input connectors with associated trimpots, and to the right of these, one merged CV output.

- **The merged CV output will produce a CV signal that represents the “sum” of all connected CV inputs.**

A few things to note:

- **Gate CV signals typically trigger notes or envelope cycles and are normally routed to a Gate input.**
- **CV signals typically control note pitch or for modulating parameters and are typically routed to CV Note or Modulation inputs.**

There are no strict rules involved, but the facts mentioned above means that it is generally better to stick to using either Gate CV signals or CV signals but not a mixture when merging. simply because the CV/Gate signals usually go to different input destinations.

For instance, merging Note CV and Gate CV from a Matrix does not make much sense if you want to use Matrix to play melodic patterns via the Sequencer Control inputs of an instrument device. There would only be one merged output whereas the instrument device would need a separate Gate and Note CV signal to work properly.

## Practical uses of merging CV

The practical applications of merging CV are perhaps less obvious compared to splitting CV. But there are numerous applications for a merged CV control output, a few of which are listed below:

→ **You can create interesting modulation effects by merging several Modulation outputs from LFO's and other CV modulation sources.**

For example, merging the Modulation outputs from several LFO's would produce a "mixed modulation" output. This merged output signal could be likened to a "super LFO" capable of generating several modulation cycles simultaneously, each with a different waveform and modulation rate! In addition to this, by using the trim control for each CV input, you have full control over the amount of modulation applied by each LFO.

The above example could of course also include Curve CV outputs from a Matrix or Mod Outs from Malström etc., in short any CV Modulation output.

→ **Use the ECF-42 Filter to apply envelope controlled filter effects.**

This can create the sound of "synthesized" percussion, and other interesting effects.

This is done using the following method:

**1. Connect the audio outputs of a Redrum to a ECF-42 Envelope controlled filter.**

**2. Connect the Gate outputs from up to 4 Redrum drum channels to the merge inputs of a Spider CV.**

**3. Route the merged output to the Env Gate input on the ECF-42.**

If you add a touch of velocity the connected Gate signals will trigger the ECF-42 filter envelope. Again, the trim pots on the Spider allows you to adjust the amount of filter envelope applied.

→ **Create an "arpeggiator" using two Matrix devices and the Spider CV Merger & Splitter.**

By merging the Note CV output from one Matrix with a Curve CV output of another Matrix, you can transpose the Matrix pattern in real-time, a bit like an arpeggiator.

**1. Create a Subtractor and a Matrix device.**

Connect the Matrix Note and Gate CV outputs to the Subtractor Sequencer CV and Gate inputs, respectively.

**2. Program a pattern for the Matrix.**

In the following text this is referred to as "Matrix 1".

3. Now create a Spider CV and a second Matrix device and connect them as in the picture below.



*Note that the Note CV output from Matrix 1, and the Curve CV output of Matrix 2 should be connected to the Spider. The merged output is connected to the Sequencer Control Note CV input on the Subtractor.*

4. **On the Spider CV, turn the trimpot for the input connected to the Note CV output fully to the right.**  
This setting will retain the correct pitch relationship for the notes played by the pattern.
5. **On the Spider CV, turn the trimpot for the input connected to the Curve CV output to “32”.**  
This will produce a Curve CV output that corresponds to semitone steps.

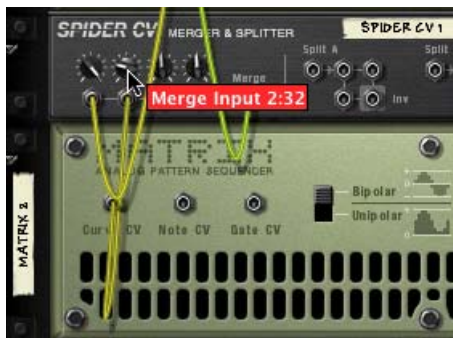

6. Set the Curve type switch to “Bipolar” on the back of the second Matrix (Matrix 2).
7. Flip the rack around so that the front panels are showing, and make the following settings for the “Matrix 2”:
  - Set the number of steps to “1”.
  - Set the Curve/Keys switch to “Curve”.
8. Adjust the Matrix 2 curve for step 1 (the only step used) so that it is in the middle of the bipolar curve as the picture shows.

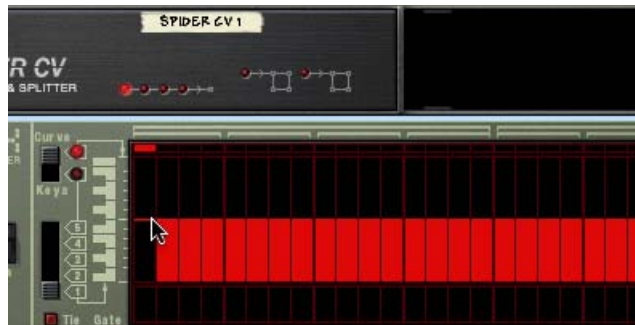

9. If you now activate Play from the transport, the pattern you programmed for Matrix 1 is played back. By carefully adjusting the Matrix 2 Curve step 1 up or down the Matrix 1 pattern is transposed in semitone steps. By programming different values for the “pattern” played by Matrix 2 and saving them in different pattern locations, you can use the Pattern selectors to transpose the Matrix 1 pattern to different keys!

## Splitting CV

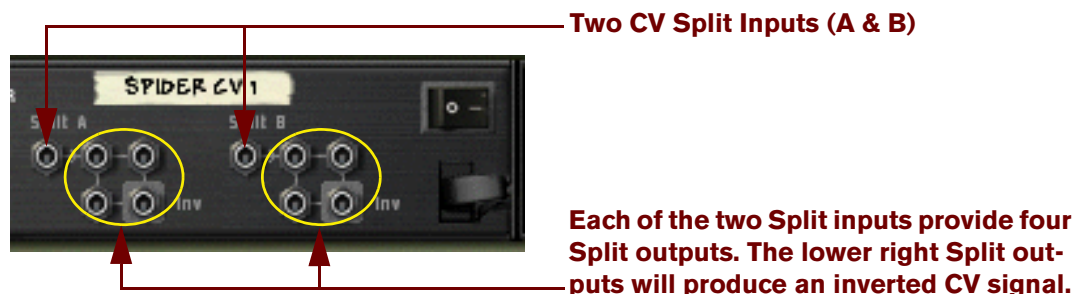

On the right half of the back panel you will find two split inputs “A” and “B”, each with four output connectors. The signal connected to a Split input will be output by all four corresponding outputs, where one is inverted.

## Practical uses of splitting CV

There are many practical uses of splitting CV signals - here are a few examples:

- **Connecting the CV Note and CV Gate outputs from a Matrix to Split Input A and B, allows you to connect the Matrix to several instrument devices.**  
Simply route the CV and Gate outputs to the corresponding Sequencer Control CV/Gate inputs on the instrument devices. Although this could also be done by copying the Matrix Pattern data to several sequencer tracks and routing the outputs to the desired devices, the advantage by using Split is if you are editing Matrix pattern data this will be immediately be reflected in all the connected devices, without any copy/paste operations.
- **Splitting modulation outputs from LFO’s, Curve CV data etc. allows you to apply modulation from one source to several parameters.**  
By using the inverted output, you can create interesting modulation crossfades, where one parameter value rises and another parameter value is lowered for example.

# RV-7 Digital Reverb



Reverb adds ambience and creates a space effect. Normally, reverb simulates some kind of acoustic environment such as a room or a hall, but you could also use it as a special effect.

- **The Reverb device can be used as a send effect or an insert effect.**

If several devices use the same type of reverb, you should connect the reverb as a send effect, to conserve computer power.

## Parameters

The display to the left on the panel shows the selected reverb algorithm - the general type of reverb. By clicking the arrow buttons you can change algorithm, with the following options available:

Algorithm	Description
Hall	Emulates a fairly large, smooth hall.
Large Hall	Emulates a larger hall, with pronounced pre-delay.
Hall 2	A hall reverb with a brighter attack than "Hall".
Large Room	Emulates a large room with hard early reflections.
Medium Room	Emulates a medium-sized room with semi-hard walls.
Small Room	A smaller room, suitable for "drum booth"-type reverbs.
Gated	A gated reverb, that is abruptly cut off.
Low Density	A thinly spaced reverb, where you clearly can here the individual echoes. Useful for strings and pads and as a special effect.
Stereo Echoes	An echo effect with the repeats alternating between stereo sides.
Pan Room	This is slightly similar to "Stereo Echoes", but the echo repeats have soft attacks.

- **If you need to conserve computer power, try using the Low Density algorithm. This uses much less power than the other algorithms.**

The selected reverb algorithm can be tweaked using the parameters on the device panel:

Parameter	Description
Size	Adjusts the emulated room size. Middle position (value 0) is the default size for the selected algorithm. Lowering this parameter results in a closer and gradually more “canned” sound. Raising this parameter results in a more spacey sound, with longer pre-delay. For the “Stereo Echoes” and “Pan Room” algorithms, the Size parameter adjusts the delay time.
Decay	This governs the length of the reverb effect. Middle position is the default decay time for the selected algorithm. Note: Decay is not used for the “Gated” algorithm.
Damp	Raising the Damp value cuts off the high frequencies of the reverb, thereby creating a smoother, warmer effect.
Dry/Wet	If you are using the reverb as an insert effect, you use this parameter to adjust the balance between the unprocessed audio signal (dry) and the effect (wet). If the reverb is used as a send effect, this should be set all the way to wet only, since you can control the balance by using the AUX send controls in the Mixer.

## CV Inputs

You can control the Decay parameter via the CV input on the back of the Reverb device.

# D-11 Foldback Distortion



The D-11 is a simple but effective distortion effect, capable of producing anything from just a whisper soft touch of distortion, to complete thrashing. This effect is most often used as an insert effect.

## Parameters

The distortion has the following parameters:

Parameter	Description
Amount	This controls the amount of distortion. The higher the value, the more distortion.
Foldback	This adjusts the character of the distortion by introducing foldback, which makes the waveform more complex. The default value is in the middle position. This produces a "flat" clipping distortion, which is the most common type. Lowering the parameter makes the sound rounder and more gentle, raising it makes the sound sharper and more evil.

## CV Inputs

On the D-11 you will find a CV input for controlling the Amount parameter. This can produce very drastic effects, especially if you control parameters in the instrument device (such as filter frequency and resonance) at the same time.

# ECF-42 Envelope Controlled Filter



The ECF-42 is a multimode filter with a built in envelope generator. It is mainly designed to be used together with pattern devices to create pattern controlled filter and envelope effects, but it can also be triggered via MIDI, or used as a “static” filter for shaping the sound of an instrument device or a whole mix.

## Usage

The Envelope Controlled Filter is best connected as an insert effect. However, unlike the other effects it is not a pure “stand-alone” device. To make the most of the ECF-42, you need either CV/Gate from an external device or MIDI notes from a sequencer track.

- **If you connect a device to the ECF-42 using audio inputs/outputs only, it will simply act as a filter with no velocity or envelope modulation.**  
Hence, all filter parameters are “static”, unless you manually turn the knobs or automate them in the sequencer.
- **Connecting a gate signal to the Env Gate input on the back panel of the device allows you to trigger the envelope generator for the filter.**  
Note that the ECF-42 envelope generator is not triggered by the audio itself - the envelope parameters won't do anything unless the device receives gate signals.
- **By creating a sequencer track connected to the ECF-42, you can have the envelope triggered by MIDI notes on the track.**  
The envelope is affected by the position, length and velocity of the MIDI notes (but not by their pitch).
- **If you are unfamiliar with basic filter and envelope parameters, please refer to “Envelopes - General” in the Subtractor chapter for a description of these.**

## The Filter Parameters



The ECF-42 filter section has the following parameters:

Parameter	Description
Mode	This button sets the desired filter mode. Three modes are available: 24dB/octave lowpass, 12dB/octave lowpass and 12dB/octave bandpass.
Freq	This is the filter cutoff frequency. When using the ECF-42 in “static” mode (without triggering the envelope), this parameter adjusts the frequency content of the sound. When using the envelope, the Freq parameter serves as the start and end frequency for the filter sweep.
Res	This is the filter resonance. Raising this produces a more extreme, “synthy” effect.
Env Amt	Determines how much the filter frequency should be affected when the envelope is triggered. The higher the value, the more drastic the effect. Note though, that if the Freq parameter is set high, raising the Envelope Amount will not make any difference over a certain value! This is because the filter is already fully opened - try lowering the Freq parameter in that case.
Velocity	This parameter determines how much the gate velocity value should affect the envelope amount.



## The Envelope Parameters



This is a standard envelope generator with Attack, Decay, Sustain and Release parameters. It is triggered by a gate signal connected to the Env Gate input on the back panel, or by MIDI notes on a sequencer track connected to the ECF-42. The parameters have the following functionality:

Parameter	Description
A (Attack)	When the envelope is triggered, this is the time it takes before the envelope signal reaches its max value.
D (Decay)	After reaching its max value, this is the time it takes for the envelope signal to reach the sustain level.
S (Sustain)	If the gate remains open (or the MIDI note is held), the envelope signal will remain on this level.
R (Release)	When the gate is closed (gate CV goes back to 0) or the MIDI note ends, this is the time it takes for the envelope signal to drop from its current value to the start value (set by the Freq parameter).

- **The Gate indicator lights up when the device receives a signal to the Env. Gate input on the back panel or a MIDI note from a sequencer track.**

## CV/Gate Inputs

On the back panel of the ECF-42, you can find the following CV/Gate inputs:

- **Freq CV.**  
Use this for controlling the filter frequency from another device. For smooth filter modulation, try connecting an LFO to this input.
- **Decay CV.**  
For controlling the envelope decay parameter from another device.
- **Res CV.**  
Allows you to control the filter resonance from another device. Can be very effective in combination with filter frequency sweeps.
- **Env. Gate.**  
This is where you connect a gate signal (e.g. from a Matrix or Redrum device) for triggering the envelope.

## Pattern Controlled Filter - An Example

This example shows how to use the ECF-42 and the Matrix to create pattern controlled filter effects. Proceed as follows:

1. **Start with an empty Song.**
2. **Create a Mixer.**
3. **Create a Subtractor Synthesizer.**  
An Init Patch will work fine for these examples.
4. **Create an ECF-42.**

## 5. Create a Matrix Pattern Sequencer.

If you flip the rack around, you can see that the audio out from the Subtractor is passed through the ECF-42 and then on to the Mixer. The Matrix Curve CV is connected to the ECF-42 Frequency CV parameter, and the Matrix Gate CV is connected to the ECF-42 Env Gate input.

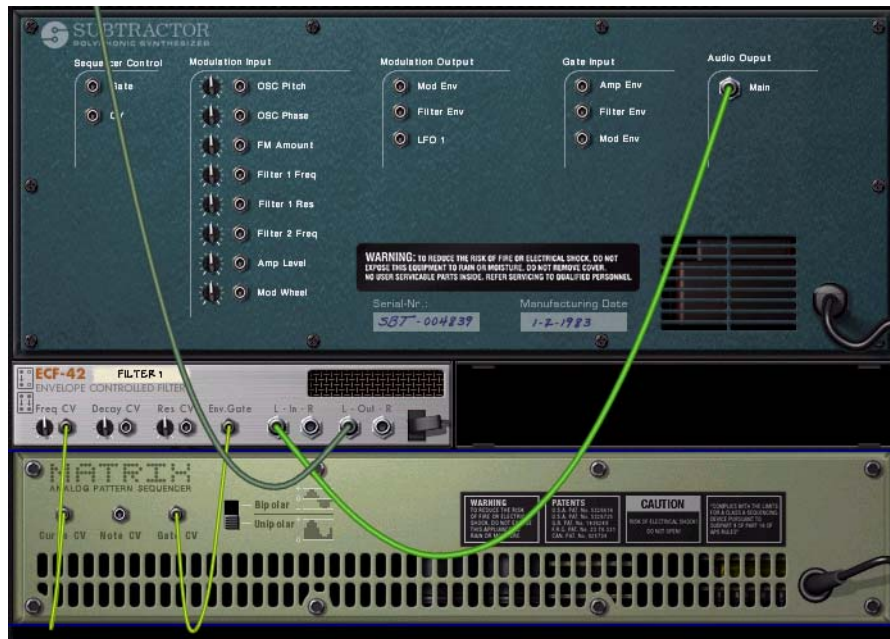

## 6. Select the Track connected to the Subtractor (given that you are handling MIDI input via the sequencer) so that you can play it from your keyboard.

If you play a few notes and turn the ECF-42 filter freq knob, you should hear the sound being filtered.

## 7. Draw a Gate pattern in the Matrix, using mixed velocity values.

Draw only a Gate pattern, not a Curve pattern.

## 8. Set both the Env.Amt and Vel knobs on the ECF-42 to about “40”.

## 9. Click the Run button on the Matrix panel.

## 10. While in Run mode, hold a chord down on your keyboard.

Now you should hear the envelope (controlling the filter) being triggered with every gate step.

- By increasing the Env.Amount, you determine how much the envelope parameters should affect the filter frequency.
- By increasing the Vel. parameter, you determine how much the gate velocity should affect the filter frequency.
- If the filter effect isn't very noticeable, try lowering the filter frequency, and raising the Res value.

## 11. Set both the Env.Amt and Vel knobs on the ECF-42 to “0”.

## 12. With the Matrix still playing, draw a Curve pattern in the Matrix pattern window.

Now, you should hear the filter frequency being modulated by the curve pattern. By combining the various parameters you can create many new filter effects.

- You can also control the ECF-42 from other devices with CV and/or Gate outputs.

## Triggering the ECF-42 via MIDI

To trigger the envelope in the ECF-42, proceed as follows:

**1. Create a sequencer track for the ECF-42.**

This is easiest done by bringing up the context menu for the device and selecting “Create Track for XX” (where “XX” is the name of this particular filter device).

**2. Record or draw some notes on the sequencer track.**

Remember that the envelope takes the note length and velocity into account. The note pitches doesn't matter.

**3. Play back the track.**

The actual notes will not be heard (since the track is connected to the ECF-42, which produces no sound in itself) but the envelope will be triggered according to the notes.

→ **You can even control the envelope “live” via MIDI: just set Master Keyboard input to the sequencer track for the ECF-42 and play your MIDI instrument!**

To route MIDI input to a track, click on the device icon in the track list, so that the Master Keyboard Input frame appears around it.

# PH-90 Phaser



The PH-90 Phaser is a classic phaser effect with some special features for fine-tuning the sound. It can create the classic sweeping phaser sounds suitable for pads or guitars, but also more extreme effects if you like. The phaser is best used as an insert effect.

## Theory

A phaser works by shifting portions of the audio signal out of phase, and then adding the processed signal back to the original one. This way, narrow bands of the frequency range (“notches”) are filtered out. When these frequencies are adjusted, a sweeping phaser sound is created.

The PH-90 is a four-stage phaser, which means that there are four “notches” in the frequency response curve (this is a little like using four notch filters with different filter frequencies - see “Notch” in the Subtractor chapter for an explanation of notch filters).

When the phaser frequency is adjusted (manually or by the built-in LFO), these notches will move in parallel in the frequency spectrum. Furthermore, you can adjust the distance between the notches (Split) and their Width. Adding feedback raises the filter gain just below each notch in the frequency range, creating a more pronounced effect.

## Parameters

Parameter	Description
Frequency	Sets the frequency of the first notch. Adjusting this will move the other notches correspondingly. This is the parameter modulated by the LFO to create phaser sweeps.
Split	This adjusts the distance between the notches in the frequency range, thereby changing the character of the effect.
Width	Determines the width of the notches. Raising the Width deepens the effect and simultaneously makes the sound more hollow and thin. This will also have an effect on character of the feedback “tone”.
LFO Rate	This is the speed of the LFO modulating the frequency parameter. The higher the value, the faster the phaser sweeps.
LFO Sync	This button lets you activate/deactivate LFO sync. When it is activated, the frequency of the LFO is synchronized to the song tempo, in one of 16 possible time divisions. The LFO Rate knob is then used for setting the desired time division. Turn the knob and observe the tooltip that appears for an indication of the time division.
LFO Freq. Mod	This determines the depth of the LFO modulation, i.e. by how much the frequency parameter should be modulated. If you turn this to zero, the effect will be a static, formant-like sound (most effective if you add a little feedback).
Feedback	This is similar to the resonance control on a filter. Raising the feedback gives a more pronounced “tone” in the effect. For “singing” phaser sounds, try raising this to the maximum.

## CV Inputs

The following CV inputs are available on the back panel of the device:

- **Freq CV.**  
Adjusts the frequency parameter. Use this e.g. for creating envelope controlled phasing (preferably with LFO Freq. Mod turned off in the device).
- **Rate CV.**  
Lets you control the speed of the modulating LFO from another device.

## About Stereo and Mono connections

The PH-90 can be connected using mono or stereo inputs, as shown by the graphs on the back panel. Note the following:

- **A “moving” stereo effect is only obtained when you use a mono input and stereo outputs.**  
With a stereo input, the two sides are processed in parallel, maintaining the stereo image of the original sound.
- **When you are using a mono input and stereo outputs, there will only be a stereo effect if the internal LFO is used.**  
If you turn LFO Mod Amount to zero, both stereo outputs will carry the same signal (mono). This is because the “fake stereo” effect is produced by inverting the modulation for one of the output channels.

# UN-16 Unison



The UN-16 simulates the sound of several detuned voices playing the same notes simultaneously. The voices are individually slightly delayed and also pitch modulated by low frequency noise. This produces a rich chorus effect with the voices spread across the stereo field (given that stereo outputs are used).

The UN-16 can be used as an insert effect or a send effect.

## Parameters

Parameter	Description
Voice Count	This switch sets the number of voices for the effect; 4, 8 or 16.
Detune	This sets the amount of detuning for the voices. Turn clockwise for stronger detuning effects.
Dry/Wet	If you are using the UN-16 as an insert effect, you use this parameter to adjust the balance between the unprocessed audio signal (dry) and the effect (wet). If the UN-16 is used as a send effect, this should be set all the way to wet only, since you can control the balance by using the AUX send controls in the Mixer.

## CV Input

One CV input is available on the back panel of the device. This controls the Detune parameter.

# COMP-01 Auto Make-up Gain Compressor



The COMP-01 compressor levels out the audio, by making loud sounds softer. To compensate for the volume loss, the device has an automatic make-up gain, that raises the overall level by a suitable amount. The result is that the audio levels become more even and individual sounds can get more “power” and longer sustain.

The COMP-01 should be used as an insert effect, either for a single instrument device or for a whole mix (e.g. inserted between a Mixer device and the Hardware Interface). There are no CV inputs for this device.

## Parameters

Parameter	Description
Ratio	This lets you specify the amount of gain reduction applied to the signals above the set threshold. The value is expressed as a ratio, from 1:1 (no reduction) to 16:1 (levels above the threshold are reduced by a factor 16).
Threshold	This is the threshold level above which the compression sets in. Signals with levels above the threshold will be affected, signals below it will not. In practice, this means that the lower the Threshold setting, the more the compressor effect.
Attack	This governs how quickly the compressor will apply its effect when signals rise above the set threshold. If you raise this value, the response will be slower, allowing more of the signal to pass through the compressor unaffected. Typically, this is used for preserving the attacks of the sounds.
Release	When the signal level drops below the set threshold, this determines how long it takes before the compressor lets the sound through unaffected. Set this to short values for intense, “pumping” compressor effects, or to longer values for a smoother change of the dynamics.
Gain meter	This shows the amount of gain reduction or increase (in dB), caused by the combined compression and make-up gain.

# PEQ-2 Two Band Parametric EQ



While there is a simple two-band shelving equalizer available for each channel in the mixer, the PEQ-2 gives you much more precise control over the tone color. The device consists of two independent, fully parametric equalizers and is most often used as an insert effect, in mono or stereo.

## About the two EQ modules

The two independent EQs are labeled “A” and “B”.

- **EQ A is always active (provided that the effect device is in “On” mode and that you have set the Gain to a value other than 0).**
- **To activate EQ B, click the button next to the EQ B parameters, so that the LED lights up.**
- **If you only use one EQ, it’s a good idea to turn EQ B off, to conserve computer power.**

## Parameters

For both EQs (A and B), the following parameters are available:

Parameter	Description
Frequency	This determines the center frequency of the EQ, e.g. at which frequency the level should be decreased or increased. The range is 31 Hz to 16 kHz.
Q	This governs the width of the affected area around the set center frequency. The higher the value, the narrower the affected frequency range.
Gain	Specifies how much the level of the selected frequency range should be boosted (positive values) or lowered (negative values). The gain range is $\pm 18$ dB.

## About the graphic display

The graphic display to the left in the device panel shows the frequency response curve as set by the EQ parameters. This gives a visual feedback and helps you tailor the EQ settings.

## CV Inputs

The following CV inputs are available on the back panel of the device:

- **Freq 1 CV.**  
Allows you to control the frequency of EQ A from another device, creating subtle or dramatic EQ sweeps depending on the Q and Gain settings.
- **Freq 2 CV.**  
Allows you to control the frequency of EQ B in the same way.



**Chapter 48**  
**Matrix Pattern**  
**Sequencer**

# Introduction

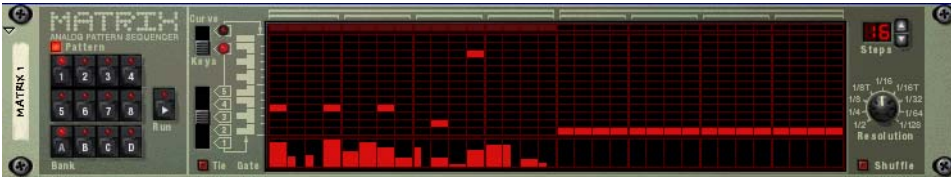

The Matrix is a pattern-based device. Matrix doesn't generate sound on its own, but has to be connected to another instrument device. It basically works by sending pattern data in the form of Note CV (pitch) and Gate CV (note on/off plus velocity) or Curve CV (for general CV parameter control) signals to a device or device parameter. The patterns can be up to 32 steps, and there are 32 memory locations for storing pattern data. The Matrix is monophonic and can control one voice in an instrument device.

Unlike most other devices in Reason, the user interface of the Matrix is not modeled on any existing hardware equivalent. The hardware devices that could be said to have similar functionality are analog step sequencers, which usually had rows of knobs that controlled the note pitch and gate values for each step.

## About the three Output types

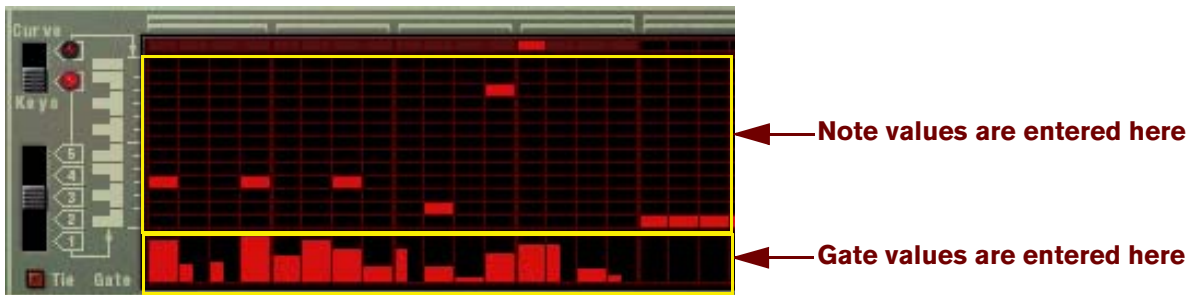

*Note and Gate CV values.*

The Matrix can produce three types of output: Curve CV, Note (Key) CV and Gate CV.

- **Note CV normally controls note pitch.**  
When connected to an instrument device Sequencer Control input, the values correspond to semitone steps.
- **Gate CV represents a note-on/off value, plus a level value (that could be likened to velocity).**

Both of these two outputs are typically connected to the Sequencer Control Gate and CV inputs on a compatible instrument device. For example, if you create a Matrix with either a synthesizer (Subtractor, Malström) or a sampler (NN-19, NN-XT) selected, they will be auto-routed in this way, and will control one voice in the device.

- **Curve CV is a separate pattern, programmed separately from the Note/Key and Gate CV.**

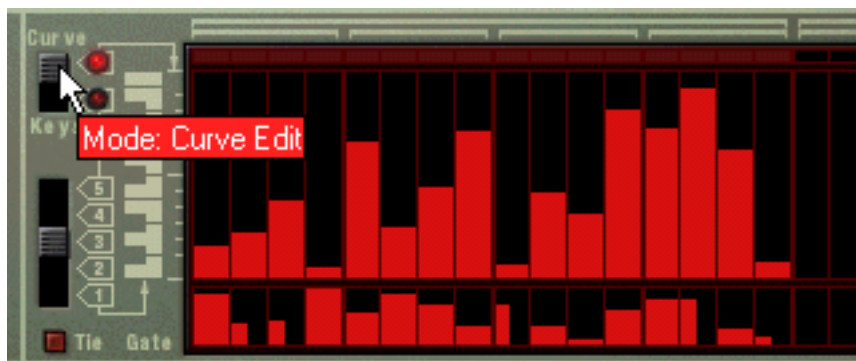

*Curve CV values (upper window).*

This is useful for programming CV curves that control other parameters other than note pitch (although you could do this too). This way you could control the note pitch and triggering from the Key and Gate outputs for a device, then add a second independent pattern using the Curve CV output that could control filter cutoff for example.

It should be stressed that all three outputs can be used in any number of ways. For example, you could use the Gate CV to trigger a drum in Redrum, or let the Curve CV control the feedback parameter of a delay, etc.

## Programming patterns

### Pattern basics

Matrix contains a built-in pattern sequencer. Unlike the main sequencer in Reason, the Matrix sequencer repeatedly plays back a pattern of a specified length. The typical example in the “real world” (as well as in Reason) is a drum machine which plays drum patterns, usually one or two bars in length.

Having the same pattern repeat throughout a whole song may be fine in some cases, but most often you want some variations. The solution is to create several different patterns and program pattern changes (automatic switching from one pattern to another) at the desired positions in the song.

### How the Matrix pattern sequencer integrates with the main Sequencer

The built-in pattern sequencer in the Matrix interacts with the main Reason sequencer in the following ways:

- **The tempo set on the transport panel is used for all playback.**  
If the Tempo track (see “Recording tempo automation”) is used, Matrix will follow this.
- **If you start playback for the main sequencer (on the transport panel), the Matrix will automatically start as well (provided the pattern sequencer hasn’t been disabled - see below).**
- **You can mute and solo Matrix tracks in the sequencer.**  
If the Matrix has a track in the sequencer and you mute this track, Matrix will automatically be muted as well. This is indicated by a Mute indicator on the device panel. If there are several note lanes on the Matrix track, their respective mute status will not be indicated on the device panel.
- **You can also run Matrix separately (without starting the main sequencer) by clicking the Run button on the device panel.**  
This starts the built-in pattern sequencer in the device. To stop playback, click the Run button again or click the Stop button on the Transport panel.
- **If you are running Matrix separately and start playback of the main sequencer, the pattern device will automatically restart in sync with the sequencer.**

- **Pattern changes can be controlled by a pattern lane in the main sequencer.**

In other words, you can record or create pattern changes in the main sequencer, and have them occur at the correct position on playback.

## Selecting Patterns

The Matrix has 32 pattern memories, divided into four banks (A, B, C, D).



*The Bank and Pattern buttons for the Matrix pattern sequencer.*

- **To select a pattern in the current bank, click on the desired Pattern button (1-8).**
- **To select a pattern in another bank, first click the desired Bank button (A, B, C, D) and then click the Pattern button.**

Nothing happens until you click the Pattern button.

The pattern change takes effect on the next downbeat according to the time signature set in the transport panel or on the transport track.

## The Pattern Enable switch



*The Pattern Enable switch.*

Next to the Bank and Pattern buttons you will find an additional switch, which is normally activated. If you click this to turn it off, the pattern playback will be disabled, starting at the next downbeat - exactly as if you had selected an empty (silent) pattern. For example, this can be used for bringing Matrix patterns in and out of the mix during playback.

## Steps

Matrix patterns consist of a number of discrete steps. For each step, you can enter a note, a CV value and a Curve value. When you run the pattern, each step will be played back in turn and will play a sound or send out the information programmed for this step. If you have ever used a drum machine, this will be obvious to you.

## Clearing a Pattern

To clear (empty) a pattern, select it and use the Clear Pattern command on the Edit menu or device context menu.

! **Note that clearing a pattern doesn't affect the pattern length, resolution or shuffle settings!**

## Using Cut, Copy and Paste

By using the Cut, Copy and Paste Pattern commands on the Edit menu or device context menu, you can move or duplicate patterns. The following rules apply:

- **Copy Pattern makes a copy of the currently selected pattern and places the copy on the clipboard.**
- **Cut Pattern moves the currently selected pattern to the clipboard.**  
This is the same as first performing Copy Pattern and then Clear Pattern.
- **Paste Pattern copies the pattern on the clipboard to the selected pattern location in the selected device.**  
This overwrites the selected pattern with the one on the clipboard.

## Transferring patterns between Reason songs

If you want to copy patterns between different Reason songs, you use copy and paste:

- 1. Open both songs.**
- 2. Select the pattern you want to copy.**
- 3. Select Copy Pattern from the Edit menu or the device context menu.**  
You can also hold [Ctrl](Win) or [Cmd](Mac) and press [C] to copy.
- 4. Make the other song active.**  
This is done by clicking in the song window or by selecting the song from the Windows menu.
- 5. Select the bank and pattern location to which you want to copy the pattern.**  
Note that any pattern already stored in that location will be overwritten!
- 6. Select Paste Pattern from the Edit menu or the device context menu.**  
You can also hold [Ctrl](Win) or [Cmd](Mac) and press [V] to copy.

# Tutorial

The programming procedure of the Matrix is to input note and gate values into the upper and lower fields of the pattern window respectively. You can input values by clicking or dragging in the pattern window. Proceed as follows:

## 1. Create a Subtractor synth.

You don't have to use the Subtractor device to use the Matrix, in fact you don't have to use an instrument device at all, but for this basic tutorial we will use a "standard" setup.

## 2. With the Subtractor selected, create a Matrix Pattern Sequencer.

The Matrix Note and Gate CV outputs will now be auto-routed to Subtractors Sequencer Control Gate and CV inputs, as you can see if you flip the rack around.



## 3. Make sure that the switch to the left of the pattern window is set to "Keys" position.

As you can see, there are two rows of red rectangles. The one with horizontal rectangles at the bottom of the upper field in the pattern window represent note pitch, for each step in a pattern. At the moment they are all set to the same note pitch. The row of vertical rectangles in the lower field represent Gate velocity values - currently these are all set to a velocity value of 100 for all steps.

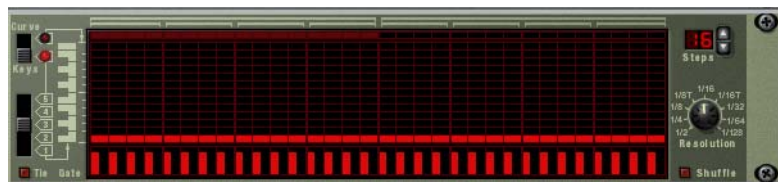

**4. Click inside the upper grid section of the Matrix pattern window.**

An orientation line is displayed in the grid to make it easier for you to find the desired note, and the red rectangles are placed according to where you click. You can drag to input continuous note values.



**5. Click and drag in the lower area of the pattern window.**

You can create vertical Gate velocity strips of varying heights. The higher the strip, the higher the velocity value.



**6. Press the Play button on the Matrix.**

The pattern you "programmed" in the previous steps is now repeated. At the top of the pattern window, a red rectangle indicates every step of the pattern.

- **If you now click or drag in the upper grid section with the pattern playing, you can hear how the note pitches change.**  
The note pitch corresponds to the keyboard printed to the left of the pattern window, in a one octave range, and as previously mentioned, an orientation line is visible when clicking or dragging, making it easy to find the note pitch on the keyboard.
- **If you now click or drag in the lower gate section while the pattern is playing, you can hear how the timbre and volume changes.**
- **If you drag some of the vertical rectangles down so that they disappear from view, the corresponding steps of the pattern are completely silenced.**
- **By using the 5-way switch below the "Keys/Curve" switch you can input notes in other octave ranges (over five octaves).**

Note that there can only be one note for each step in the pattern.



**7. By using a combination of the methods described in the above steps, you can program suitable note values for each step, decide which steps should be played and set their velocity with the gate values.**

## Using Curve Patterns

Curve patterns are independent patterns that can be applied separately to the note pattern programmed in “Keys” mode. If you switch the Keys/Curve switch to “Curve”, the note, but not the gate steps, disappear from view, and leaves the upper area of the pattern window empty. You can now start programming a curve pattern. Proceed as follows:

**1. Draw a curve, using the same method as for notes or gates.**

As you can see, the Curve pattern looks like large vertical gate steps.

→ **If you play the pattern, nothing has changed, i.e. the pattern sounds exactly like it did before the Curve pattern was drawn.**

This is because the Curve CV output hasn't been connected to any parameter yet.

**2. Flip the rack around so you can see the back panel of the Matrix.**

**3. Connect the Curve CV output to the Filter Cutoff Modulation Input on the Subtractor.**

Now the curve pattern controls the filter frequency of the Subtractor.

– **If the effect isn't very noticeable, try raising the filter Q parameter, and lowering the filter frequency.**

→ **The Curve CV output can be connected to any device CV or Modulation input.**

Actually, Curve CV signals can also produce Gate triggers (used for triggering samples or envelopes for example).

→ **A Gate trigger is produced for each curve pattern step that follows a value of “0”.**

If you look at the picture below, steps 2,4 and 6 will produce a trigger, because steps 1, 3 and 5 are set to zero, but the rest of the pattern would not.



## About Unipolar and Bipolar Curves



On the back panel of the Matrix you will find a switch, allowing you to select between “Unipolar” or “Bipolar” Curves. The difference is as follows:

→ **A unipolar curve has values starting from “0” and up.**

“0” is the value produced by all steps when they are “empty” (not visible). Unipolar is the default setting of this switch when a new Matrix is created.

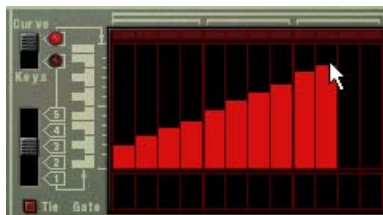

*Unipolar curve*



- **A bipolar curve is divided in the “middle”, with the middle representing a value of “0”.**

The curve reflects this. If no curve has been drawn and you switch to bipolar mode, all steps go from the bottom up to the middle of the scale printed to the left of the pattern window. Thus, all steps are at “0”, and the curve can be drawn both up and down from the middle.

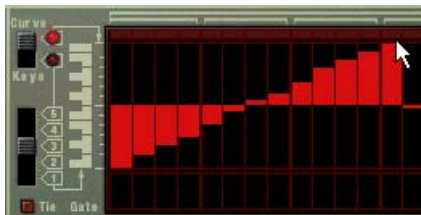

*Bipolar curve*

Bipolar curves are essential in some instances. If you want to use the Matrix to CV control the Pan parameter for a mixer channel for example, a unipolar curve would start at zero - which for Pan equals center position. This means that you would only be able to use the curve to pan in *one direction* from this center position. A bipolar curve however, will have the zero value in the middle, allowing you to draw pan curves in both directions. Bipolar curves can also be used for controlling parameters with positive and negative values.

## Setting Pattern Length



You may want to make settings for Pattern length, i.e. the number of steps the pattern should play before repeating:

- **The “Steps” spin controls are used to set the number of steps you wish the pattern to play.**

The range is 1 to 32. You can always extend the number of steps at a later stage, as this will merely add empty steps at the end of the original pattern. You could also make it shorter, but that would (obviously) mean that the steps you remove won't play back. The steps you remove aren't erased though, if you set the step number back again, anything recorded in the previously removed step locations will be played back.

## Using Tied Notes

If you activate “Tie” to the left of the Gate pattern window, you can create longer notes (eighth notes, quarter notes etc.). A quick way to draw tied gates is to hold down [Shift] when you input the gate values.



*Entering tied gate values.*

- **Each step that has one tied gate value will be twice the length compared to a normal step.**  
Tied gate steps are indicated by being twice as wide in the pattern window.
- **If two or more notes of the same pitch are tied together, the result will be even longer notes.**

Tied notes are also essential if you want to create typical TB-303 “Acid”-type lead lines - see [“Programming “Acid Style” lead lines”](#).

## Setting Pattern Resolution

Matrix always follows the tempo setting on the transport panel, but you can also make Matrix play in different tempo “resolutions” in relation to the tempo setting.

## Pattern Shuffle

Shuffle is a rhythmic feature, that gives the music a more or less pronounced swing feel. It works by delaying all sixteenth notes that fall in between the eighth notes.



*Straight sixteenth note pattern (viewed in the sequencer).*



*The same sixteenth note pattern with shuffle applied.*

In Reason, you can activate or deactivate shuffle individually for each pattern in a pattern device. However, the amount of shuffle is set globally with the Global Shuffle control in the ReGroove Mixer. The ReGroove Mixer is described in [“The ReGroove Mixer”](#).



*The Shuffle on/off switch in Matrix and the Pattern Shuffle control on the transport panel.*

## Pattern Mute

If you deactivate the “Pattern” button above the Pattern select buttons, the pattern playback will be muted, starting at the next downbeat (exactly as if you had selected an empty (silent) pattern). For example, this can be used for bringing different pattern devices in and out of the mix during playback.

If you mute the Matrix track in the sequencer, it is muted instantly and the Mute indicator lights up on the panel. Note that all tracks connected to the Matrix must be muted for this to work.

## Pattern Functions

When a pattern device is selected, you will find some specific pattern functions on the Edit menu (and on the device context menu).

### Shift Pattern Left/Right

The Shift Pattern functions move the notes and corresponding gate values in a pattern one step to the left or right.

### Shift Pattern Up/Down

**! This function does not alter the Curve CV. This is because the values produced by the Curve CV do not necessarily correspond to semitone note steps at all.**

The Shift Pattern functions will transpose all the notes in a pattern one semitone up or down.

### Randomize Pattern

The Randomize Pattern function create random patterns. These can often be great starting points and help you get new ideas. Both Note, Gate and Curve CV values will be created.

### Alter Pattern

The Alter Pattern function modifies existing patterns. Note that there must be something in the pattern for the function to work on - using an Alter function on an empty pattern will not do anything.

**! Note that Randomize and Alter affects both the Gate, Note and Curve CV!**

## Chaining Patterns

When you have created several patterns that belong together, you will most probably want to make these play back in a certain order.

→ **Simply activate record for the track with the Matrix as the destination in the sequencer and use the Pattern and Bank buttons to determine the playback order as the Song is playing.**

The Patterns play to the end before changing, so you won't have worry too much over the "timing" of the pattern changes you input manually. When you are done, the sequencer track will contain pattern change data, and the patterns will automatically switch according to the order set while recording. More on recording pattern changes on "[Recording pattern automation](#)".

→ **An alternative way to do this is editing directly in the Pattern Edit lane in the sequencer.**

Editing in the Pattern lane is described in the Sequencer chapter.

# Converting Pattern data to notes in the main sequencer

You can convert Matrix Patterns to notes in the main sequencer. This allows you to edit the notes freely, create variations or use Groove quantizing.

## The “Copy Pattern to Track” function

This function is useful when you have created a single pattern in the Matrix device and want to render individual note events on a sequencer track.

**! Curve patterns cannot be converted to sequencer data! Only the note pattern and the gate values will be converted.**

Proceed as follows:

**1. Set the Left and Right Locators to encompass the section you want to “fill” with the notes in the pattern.**

You may want to make sure that the space between the locators is a multiple of the pattern length, to avoid “cutting off” the pattern.

**2. Select the track you wish to copy the rendered notes to.**

You should not copy the notes to the Matrix track, but to the track for the device controlled by the Matrix (since the Matrix doesn't produce any sound in itself). You can also copy the notes to any other instrument track if you like.

**3. Select the Matrix device in the rack and select “Copy Pattern to Track” from the Edit menu or the device context menu.**

The pattern is converted to a single note clip on the track, with Note and Gate (Velocity) values. If the space between the locators is greater than the pattern length, the pattern will be repeated in the clip to fill up the space.

When you use the “Copy Pattern to Track” function with the Matrix, you should note the following:

- **A note will be created for each pattern step which has a Gate value greater than zero.**

The notes will have the pitch according to the key CV value for the step, and the velocity according to the Gate value.

- **The Curve CV is not copied.**

- **You may want to disconnect or even remove the Matrix device after performing this function.**

This is because you probably don't want both the Matrix and the sequencer notes to play the device at the same time and thus cause “note doubling”.

- **The procedure above copies a single pattern to notes in the sequencer. If you have automated pattern changes, you can copy a complete pattern track to notes, taking all pattern changes into account.**

## The “Convert Pattern Automation to Notes” function

If you have recorded or drawn pattern automation on a Matrix track, you can have the whole track converted to notes, in the following way:

**1. Select the track with the pattern automation.**

**2. Select “Convert Pattern Automation to Notes” from the Edit menu or the context menu for the track.**

For each pattern clip, the corresponding pattern is converted to note clips on the track (following the same rules as for the “Copy Pattern to Track” function). The track will play back just the same as when you played the pattern device with the pattern changes.

- **After the operation, the Pattern Select lane is switched off.**

The Pattern (Enable) button on the device is automatically turned off.

- **When you use this with a Matrix, you need to move the note clips to the track of an instrument device (typically the device to which the Matrix is connected).**

This is because the Matrix doesn't make any sound itself.

# Example usage

As mentioned previously, the Matrix is a very flexible device. Here follows a few examples of how you can use the Matrix Pattern Sequencer.

## Using the Matrix for modulation

You can effectively use the Matrix as a modulation source, much like an LFO. Just like the LFOs in Reason's instrument devices, the Matrix can generate modulation that is synchronized to tempo, which has many advantages. Proceed as follows:

- 1. Create a Synthesizer (e.g. a Subtractor or Malström).**
- 2. Create a Matrix Pattern Sequencer, or if one already exists, set it to an empty pattern.**
- 3. Flip the rack around and disconnect the Gate and Note CV outputs.**  
Gate/Note CV is not used in this example
- 4. Flip the rack around and connect the Curve CV output on the Matrix back panel to the "Amp Level" Modulation input on the synthesizer.**  
This parameter is used for modulating the output level (volume) of the synthesizer. Volume modulation is often referred to as Tremolo. You can use a unipolar curve (see "[About Unipolar and Bipolar Curves](#)") for this example.
- 5. Flip the rack back again, and switch the Matrix to display the Curve pattern window.**
- 6. Draw a curve like the one shown in the illustration below.**  
If you use fewer or more steps than 16 (as shown in the picture), just draw the curve so that it roughly matches the shape in the picture.

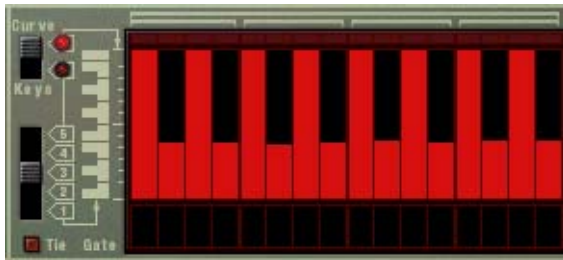

- 7. Activate Click on the Transport Panel.**
- 8. Select the track that is routed to the synthesizer, so that you can play it from your MIDI keyboard.**
- 9. Activate Play on the transport panel, and hold a chord down on your keyboard.**  
You should now hear the volume being modulated by the Curve pattern.
- 10. While still in play mode, you can use the Resolution knob to change the modulation "rate" in relation to the tempo.**  
For each clockwise resolution step the modulation speed is doubled and vice versa, but it will always stay in sync with the tempo.

## Programming “Acid Style” lead lines

By “acid style” lead lines we mean patterns that use a combination of Legato and slide (or portamento) effects to produce the widely used hypnotic “wavy” sound produced by the original Roland TB-303, and recreated in the Propellerhead Software product ReBirth. To approximate this typical sound using Reason, proceed as follows:

1. **Create a Synthesizer (Subtractor or Malström).**
2. **Create a Matrix Pattern Sequencer, or if one already exists, set it to an empty pattern.**
3. **Make sure that the Note and Gate CV outputs are connected to the synthesizers Sequencer Control CV and Gate inputs, respectively.**
4. **For Subtractor, select either a Init Patch, or use the “TB Synth” patch in the Monosynth category of the Reason Factory Sound Bank.**
  - **If you use an Init patch, it is important that you make the following settings:**
    - **Set Polyphony to “1”.**
    - **Switch Trigger Mode to “Legato”.**
    - **Set Portamento to a value around “50”.**
5. **Create a pattern in Matrix, and keep it playing back.**
  - **If “Tie” (see “Using Tied Notes”) now is activated for a step, the note will be tied to the next and the pitch will continuously “glide” to the pitch of the following step.**

Please note that Tie should be activated on the note you wish to slide from, and not the note you slide to.
  - **If you have several tied notes, one after the other, they will play as one long legato phrase. This can be used to create “wavy” lead lines with pitch bend effects.**
6. **Experiment with different Note, Tie and Gate values.**

If you have ever used a TB-303 or ReBirth, you should now begin to get the hang of how you can create patterns in that particular style by using the Matrix together with a synthesizer.

  - **Adding a DDL-1 (delay), and a D-11 (distortion) effect device will make it sound even more “ReBirth”-like, but of course you are also able to get a much wider range of timbres by utilizing Reason’s other sound and modulation capabilities.**

## Triggering samples

The Gate CV output can be used to trigger samples, either in Redrum or in the NN-19 or NN-XT Sampler.

- **Connect the Matrix Gate CV out to the Gate (Sequencer Control) in on the NN-19/NN-XT or to one of the individual Gate Channel inputs of Redrum.**

Gate values will now trigger the sample on each step with Gate values above “0”.

# **Chapter 49**

## **RPG-8 Arpeggiator**

# Introduction



An arpeggiator generates rhythmic note patterns (arpeggios) from notes or chords. The RPG-8 Arpeggiator doesn't generate sound on its own, but has to be connected to another instrument device (just like the Matrix). It works by converting MIDI note data (input to the RPG-8) to Note CV (pitch) and Gate CV (note on/off plus velocity) signals. These CV/Gate signals are sent to the corresponding Sequencer Control inputs of an instrument device.

In addition to standard arpeggiator features the RPG-8 is equipped with a 16 step pattern editor for creating rhythmic variations.

The RPG-8 is monophonic and can control one voice in a connected instrument device.



# Using the RPG-8

## Setting up

The basic procedure is to input note data, either live or recorded, to the RPG-8 device. This note data is in turn sent to a target device via its Sequencer Control CV/Gate inputs. The resulting output from the target device can either be arpeggiated notes or simply mirror what is played on your control surface device. Proceed as follows:

**1. Create an instrument device, e.g. a Subtractor.**

Select a suitable patch, preferably one with a short attack time.

**2. With the instrument device selected, create an RPG-8 Arpeggiator.**

A sequencer track with MIDI focus named “Arp 1” is created for the RPG-8. The RPG-8 Note and Gate CV outputs will be auto-routed to the instrument device Sequencer Control Gate and CV inputs, as you can see if you flip the rack around. In addition, the Mod Wheel and Pitch Bend CV outs are also auto-routed to the corresponding modulation inputs on the target device.

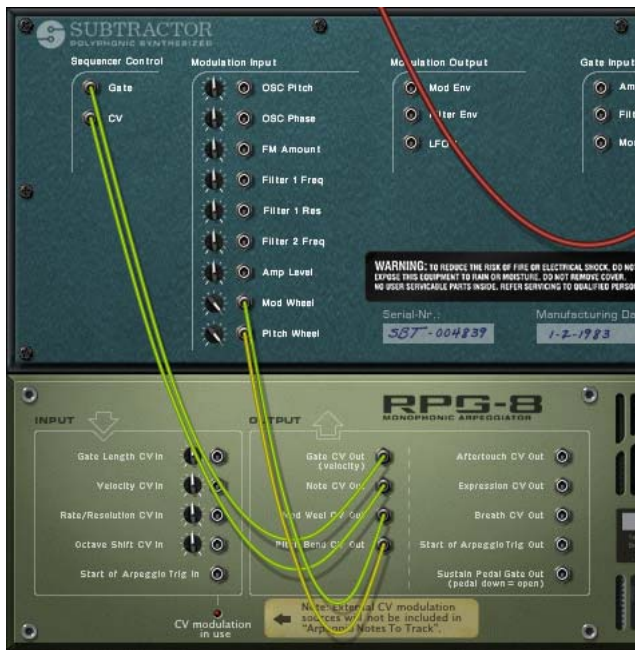

**3. Make sure the Arpeggiator Enable (“On”) button on the upper part of the panel is activated.**



#### 4. With Master Keyboard input set to the **Arp 1** sequencer track, play a few notes.

The notes in the chord you play are now arpeggiated for as long as you hold down the keys. The arpeggio will change directly if you release all notes and play another note or chord. If you add notes while holding down a chord, the arpeggio will continue with the added notes.



- **The display shows the notes played by the arpeggio pattern, with small bars indicating pitch for each step. The display is continuously updated as you play.**
- **The arpeggio will play in sync with song tempo by default in new RPG-8 devices.**
- **You do not need to start playback to generate arpeggios.**
- **Try changing the arpeggiator mode using the Mode knob.**  
The various modes govern how the notes are arpeggiated. For example “Up” means from lowest note to highest note, Up+Down from lowest to highest note, then back down to lowest note again. For a description of all the modes see “[Mode switch](#)”.
- **By activating the Hold button the arpeggio will continue to play even if you release the keys.**  
If you play a new chord the arpeggio will continue to play, using the new notes. To stop the arpeggio, deactivate the Hold button or hit Stop on the transport. See “[Hold On/Off](#)”.
- **The “Insert” buttons can be used to introduce further variations to the arpeggio.**  
See “[Insert buttons](#)”.
- **If you change the Rate parameter the rate of the arpeggiated notes will follow the song tempo at the selected note value resolution.**  
Straight, triplet and dotted note values are available. The arpeggiator can also be free running, i.e. not synced to tempo - see “[Rate](#)”.
- **The Gate Length knob allows you to adjust the length of the arpeggiated notes.**  
If the knob is turned fully clockwise (“Tie”), the gate is always open (the notes will be played legato). If it is turned fully counter-clockwise, the gate is closed (no sound). See “[Gate Length](#)”.
- **By using the Octave buttons beside the Mode knob you can increase or decrease the octave range of the arpeggio.**  
With “1 Oct” selected the arpeggiated notes will be those that you press down on the keyboard. If “2 Oct” is selected the range will be expanded so that the arpeggiated notes play over two octaves, and so on - see “[Octave range buttons](#)”.
- **You can transpose the arpeggio up or down in octave steps using the Octave Shift buttons.**  
See “[Octave Shift](#)”.
- **By using the Velocity knob you can set the arpeggio to play with a fixed velocity value (selectable between 1 to 127) for all notes. Turning the knob fully clockwise to the “Manual” position means that the arpeggio notes will use the same velocity as the MIDI notes you input.**  
By using the Manual mode and varying the velocity for individual notes the arpeggio will become more animated and rhythmic. See “[Velocity](#)”.

That covers the basic principles of how to set up and use the RPG-8 to arpeggiate notes that you play in real time. But to make full use of the RPG-8 there are many further applications:

→ **You can of course record and edit the notes you input.**

You can also render the arpeggio output “to track” for full sequencer edit control of the notes generated by the RPG-8 - see [“Rendering arpeggio notes to track”](#).

→ **You can introduce rests for more complex rhythmical arpeggios by using the Pattern editor.**

See [“Pattern editor”](#) for a description.

→ **You can use the RPG-8 as a MIDI to CV converter which allows you to freely assign common performance MIDI controllers like Mod Wheel and Aftertouch to control parameters - see [“Using the RPG-8 as a MIDI to CV converter”](#).**

## Recording MIDI note data for the RPG-8 - simple tutorial

The notes that you feed into the Arpeggiator can be recorded and edited in the sequencer. This works pretty much like recording/editing normally, but with a few exceptions which will be duly noted.

In this section we will go through the basic principles of recording MIDI data. As several functions are described later in this chapter (e.g. the Pattern editor) we will keep things simple in this tutorial.

To record the notes you play into the RPG-8 you proceed as follows:

**1. Set Master Keyboard input to the “Arp” track.**

Make sure the RPG-8 is connected to a target instrument as described in [“Setting up”](#).

**2. Make sure the “On” button for the Arpeggiator is activated.**

If you play a chord, this will now be arpeggiated.

**3. Set up the RPG-8 as you want it to play arpeggios.**

For detailed descriptions of all the parameters, see [“RPG-8 Parameters”](#).

- **Note that if an arpeggio is playing before you enter recording, the notes that generated this arpeggio will not be recorded! This is because the note-ons have already occurred before recording commenced - only the notes that you enter after recording has started will be recorded.**

**4. Click the Record button in the main sequencer and start playing.**

**5. Hit stop when you are done recording.**

A clip has now been added to the Arp track containing the notes you just recorded. If you play back the clip from the top the arpeggio will play back as you recorded it.

- **If you switch to Edit mode for the Arp track, you will see that only the notes that you input to the RPG-8 were recorded - not the actual arpeggio notes generated by the RPG-8 and sent to the target device.**

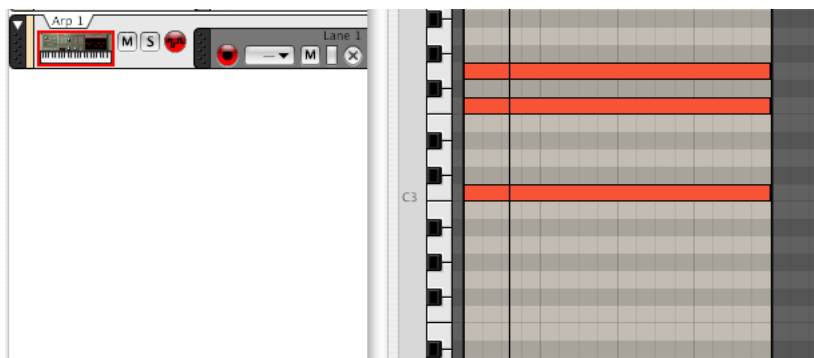

The arpeggio you “recorded” is actually still being generated rather than played back. The only difference is that now the arpeggio is generated from the notes you recorded on the track rather than from the notes you played live. Thus, if you change any RPG-8 parameters like Rate or Mode this will change the arpeggio you hear.

When using this method the following points should be noted:

- **It will not be possible to edit the individual notes generated by the arpeggiator, only the source notes you play.**  
This may be fine, depending on the situation. If you simply played some wrong notes you can easily edit them in the sequencer as usual.
- **If you used Hold when recording (or if you activate Hold during playback) the arpeggio will play for as long the sequencer is in Play mode or until Hold is deactivated.**  
It is generally better to have Hold off when recording.

Depending on the situation, the above limitations may or may not be of concern. But there is a quick and effective solution to all above mentioned issues; the “Render Arpeggio Notes to Track” function (see “[Rendering arpeggio notes to track](#)”).

## Using multiple Lanes

You can record note data on several Lanes of the RPG-8 (Arp) track. If you do this, any overlapping note data will be merged and will not play separate arpeggios. The Arp track will always produce a monophonic output regardless of how many overlapping Lanes there are.

If you want to use separate simultaneous arpeggios, with each controlling one voice in a device, you have to use the “Arpeggio Notes to Track” function (see “[Rendering arpeggio notes to track](#)”) to separate Lanes in the target device track.

## Generating arpeggios from already recorded tracks

The RPG-8 can also be used to arpeggiate notes copied/moved from other tracks:

- 1. Copy the clip(s) containing the notes you wish to arpeggiate.**  
You can also drag and drop clips between tracks to do this.
- 2. Paste the clip(s) to the “Arp” track.**
- 3. Activate Arpeggio On and activate playback.**
- 4. If you only wish to hear the arpeggio, mute the sequencer track/lane you copied the source data from.**  
If you leave it unmuted you will hear both the original chords and the arpeggio.

## Rendering arpeggio notes to track

This function allows you to render the arpeggio generated by RPG-8 to the target device track. The arpeggio output - rather than just the source notes that generate the arpeggio - will be rendered as notes allowing for full sequencer edit control.

After rendering, the target device track will have a clip with the arpeggio notes and the RPG-8 track should be muted, so no arpeggiator parameter settings can be changed - only the actual notes can be edited. You can of course always go back to the original Arp track, change arpeggiator parameters and perform the rendering again at any time. To perform the rendering, proceed as follows:

**1. First, record some notes in the sequencer.**

The Arp track should be selected when recording as usual.

**2. Set the left and right locators to the desired range or length.**

If the range set is longer than the arpeggio pattern(s), the data will be repeated to fit the range.

**3. Select the sequencer track that the RPG-8 is connected to, i.e. the target track, not the “Arp” track.**

**4. Select the RPG-8 device you wish to copy the arpeggio(s) from in the rack.**

**5. Select “Arpeggio Notes to Track” from the Edit menu or the RPG-8 device context menu.**

Now notes will be created on the target device track between the left and right locators, according to the selected arpeggio.

**6. Mute the Arp track originally used to generate the arpeggio. If you now activate playback from the transport the arpeggio will play back as note data (the RPG-8 is inactive).**

If you enter sequencer Edit mode for the target device track, you can freely edit the arpeggio notes.

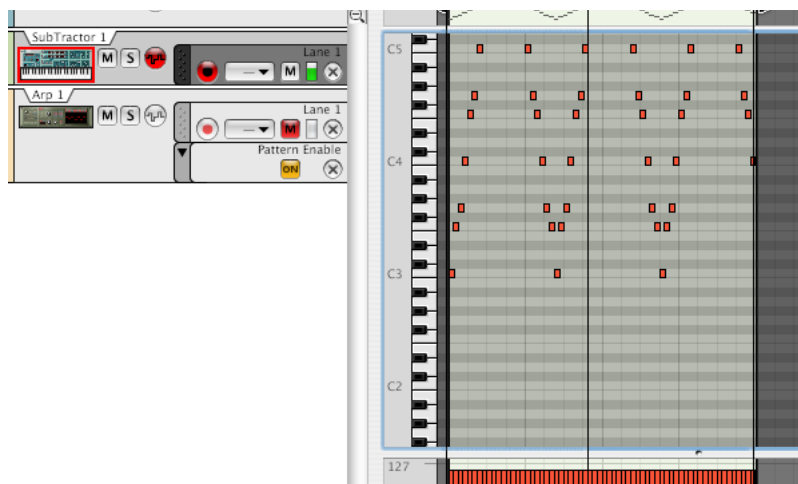

→ **Performance data (e.g. Pitch Bend or Mod Wheel) recorded on the Arp track are not included in the “Arpeggio Notes to Track” operation.**

If you have performance data that should be played back with the arpeggio, you need to copy it manually to the rendered note clip.

# RPG-8 Parameters

## MIDI-CV Converter parameters



The MIDI-CV Converter section to the left contains parameters that affect the CV output from the RPG-8, regardless of whether the Arpeggiator section is activated or not. The following parameters are available:

### Velocity

The Velocity knob can be used to set a fixed velocity value for the notes that are output via the Gate CV Out jacks on the back of the RPG-8. If you set the Velocity knob to a value between “0” and “127”, the Gate CV Out will be fixed (at the set value) regardless of the velocity of the incoming MIDI notes.

Turning the knob fully to the right activates Manual (“Man.”) mode (a LED is lit when activated). In Manual mode the velocity levels will be sent out via the Gate CV Out with the same velocity value as they are input, i.e. “what goes in, will come out”. Manual mode is on by default in new devices.

There is also a “Velocity CV” input at the back. If this is connected to a controller source (a LFO modulation output for example), the output will be a merge between the Velocity setting and the applied CV modulation by the LFO - see [“CV Inputs”](#).

### Hold On/Off

If the Hold parameter is activated (lit button), an arpeggio will continue to run even if you release all keys. It will continue to arpeggiate the last notes played until a new note-on is received.

- **If you continue to hold down at least one key when Hold is on, any new notes will be added to the existing arpeggio as opposed to starting a new arpeggio.**
- **If the Arpeggiator section is off, and the Hold function is activated, there will be no note-offs for incoming notes played (i.e. the CV Gate stays open).**
- **The Hold On/Off status responds to Sustain Pedal messages - as long as the pedal is pressed down, Hold will stay activated.**

### Octave Shift

This allows you to transpose the RPG-8 Note CV output in octave steps. You can octave shift up or down 3 octaves. Octave Shift can also be CV controlled.

# Arpeggiator parameters



The middle section contains the Arpeggiator parameters that govern how the arpeggio is played. The following parameters are available:

## Arpeggiator “On” button

This switches the Arpeggiator on or off.

## Mode switch

This determines the direction of the arpeggio notes.

Mode	Description
Up	This will generate an arpeggio that plays from the lowest note to the highest note.
Up+Down	Notes are played from lowest note to highest, then from highest back down to the lowest. The very lowest and the highest arpeggio notes are not repeated. I.e. the arpeggiator will play the lowest note to the second highest note, then the highest note to the second lowest note.
Down	Notes are played from the highest note to the lowest note.
Random	The notes you input will be arpeggiated randomly.
Manual	Notes are arpeggiated in the same order they are played when input.

## Octave range buttons

The Octave buttons allow you to set the octave range of the arpeggio.

Use as follows:

Octave range	Description
1 Oct	The arpeggiated notes will be those that you press down on the keyboard.
2 Oct	If you select this, the arpeggio will be extended to a two octave range, i.e. the arpeggio pattern is played then repeated one octave up. In Random mode, the notes you input are played in random order over 2 octaves.
3 Oct	Same as 2 Oct but extended to a three octave range.
4 Oct	Same as 2 Oct but extended to a four octave range.

## Insert buttons

Insert can be used to add variations to the arpeggio by repeating certain notes in a predetermined order. It works as follows:

Insert mode	Description
Off	No Insert repeat.
Low	The lowest note is repeated in between every second note in the arpeggio.
Hi	The highest note is repeated in between every second note in the arpeggio.
3-1	The arpeggio will play 3 notes forward, then step 1 note back and from there play 3 notes forward etc.
4-2	The arpeggio will play 4 notes forward, then step 2 notes back and from there play 4 notes forward etc.

## Rate

This sets the rate of the arpeggio. There are two basic modes for the Rate parameter:

- **If Sync is activated, the Arpeggiator will play in sync with the sequencer tempo. By changing the Rate you can make the Arpeggiator play in different tempo resolutions in relation to the tempo setting.**  
Straight, dotted or triplet note values are available in 1/2 to 1/16 resolutions. In addition, there are also 1/32, 1/64 and 1/128 (straight) note resolutions.
- **If the “Free” button is activated, the arpeggio rate is free running, and not synced to tempo.**  
The Rate is then selectable from 0.1 to 250Hz.

## Gate Length

This determines the length of the arpeggio notes. Minimum value is 0 (Gate closed - no output). Maximum value is “Tie”, meaning the gate is open all the time. This parameter can be controlled via CV.

## Single Note Repeat

Single Note repeat governs how the arpeggiator behaves when the user plays single keys or monophonic lines.

- **When Single Note Repeat is on, a single key will retrigger the gate, meaning the note will repeat.**  
If the Octave setting is 1 Oct, the note will simply repeat (given the Gate Length setting is not set to “Tie”). If the Octave setting is set to anything else, the note will repeat according to the Octave, Mode and Insert settings.
- **When this is off, single notes will not repeat and RPG-8 will play arpeggios when the user plays more than one key (chords).**



## Shuffle

Shuffle is a rhythmic feature, that gives the arpeggio a more or less pronounced swing feel. It works by delaying all sixteenth notes that fall in between the eighth notes.

In the RPG-8 you can switch Shuffle on or off using the corresponding button. However, the amount of shuffle can be set globally (for all devices that incorporate this feature) with the Global Shuffle control in the ReGroove Mixer.



*The Shuffle on/off switch in RPG-8 and the Global Shuffle control in the ReGroove Mixer.*

## Pattern editor



The Pattern editor allows you to introduce rests for arpeggio steps which can produce more rhythmic results. The Pattern editor has 16 step buttons at the top, and a main grid display where the arpeggio notes are represented as horizontal bars for each step in the arpeggio. The pitch of the arpeggio notes are shown on the vertical axis. Notes within the C-1 to C7 octave range are shown. Notes cannot be edited in the display, they are only a visual representation of the arpeggio.

→ **The Pattern editor is activated with the “Pattern” button.**

When activated, the Pattern button and the 16 Step buttons light up.

- **When you play a chord (or in case you have recorded notes, when you start playback) the arpeggio will play according to the current Arpeggiator parameter settings, as normal.**

The only difference is that a pattern will be repeated in the display so that all 16 steps play the pattern.



*A three note chord with Pattern off..*



*...and with Pattern on.*

- **If you click on a step button it goes dark. This means that this step will insert a rest in the arpeggio pattern.** Note that no arpeggio notes are “skipped”. Inserting a rest means that the step will be silent and the next active step will play the next note in the arpeggio pattern.
- **The “Steps +/-” buttons can be used to set the number of steps in the Pattern editor.** E.g. if you press the “Steps minus” button four times the last four step buttons will go dark and the Pattern editor cycle will start over after step 12.

## Pattern functions

When the Pattern editor is activated, you will find some specific pattern functions on the Edit menu (and on the device context menu). These are as follows:

Function	Description
Alter Pattern	The Alter Pattern function modifies existing step patterns. Note that there has to be a pattern to start with - using the Alter function if all step buttons are active (or inactive) won't do anything.
Randomize Pattern	The Randomize Pattern function creates random patterns.
Invert Pattern	This will invert the pattern, i.e. active steps will become rests and vice versa.
Shift Pattern L/R	The Shift Pattern functions move the pattern one step to the left or right.

## Automating the Pattern editor

To automate the RPG-8 step buttons a little planning is necessary.

- **In the sequencer, each automation point represents all the possible combinations of each of the 16 step buttons on/off status, so the numbers become slightly bewildering (there are 65535 possible variations).** This makes it difficult to control the automation by drawing events in the sequencer as each position represents a different combination of *all* the button's on/off status.
- **You can of course automate the buttons manually while recording but this is not always a solution as you may wish to change the on/off status of several buttons simultaneously.**

The solution to both these issues is to record “snapshots” of the Pattern editor:

**1. Set up the buttons as you want them from the start of the song, e.g. all buttons “on”.**

This will be your “static value” which is active from the start.

**2. Right-click the buttons and select “Edit Automation” from the context menu.**

A Pattern automation lane is created and the Pattern buttons will have a green rectangle around them to indicate that they are automated.



**3. Start the sequencer in play mode, and set up the buttons as you want them (except one - see below) for the new pattern combination.**

Note that the Automation override indicator on the transport will light up, but this is as it should be.

To record the button's status, you need to press at least one button after entering record mode. Thus, you need to save one “last” button to press during record to automate the Pattern editor to an exact combination of the 16 button's on/off status.

**4. Enter record mode and press the “last” step button where you want the automation to happen. Continue recording for as long as you wish the pattern to play, then click stop.**

A clip has been added on the Pattern automation lane.

**5. If you open the clip by double-clicking on it in the Arrange view you can see that the clip has one automation point.**

Note that it is the clip that governs the start and duration of the automation, not the point itself.

**→ If the snapshot automation is not in the right time position, you can simply reposition the clip so that it starts where you want the change to occur using the usual methods.**

When the clip you recorded ends, the buttons will revert to the static value you set up in step 1.

**6. By using this general method you can continue to add further clips to the Pattern lane, each containing a “snapshot” of the Pattern editor buttons.**

# CV connections



On the back of the RPG-8 you can find a number of useful CV connectors. These are as follows:

## CV Inputs

There are five CV inputs, of which four can be used to control RPG-8 parameters that have associated controls on the front panel. These parameters are Gate Length, Velocity, Rate and Octave Shift.

If you use an external source to modulate these parameters, the incoming CV is merged with the setting on the front of the device.

An example: Velocity is set to 50 on the front panel. A Matrix (bi-polar curve) that varies between  $\pm 20$ , with the voltage trim pot set to 64 (50%) is connected to the Velocity CV input. The resulting Velocity should then vary between 40-60.

In addition to the above CV inputs, there is a "Start of Arpeggio Trig In" connector. This restarts the arpeggio figure from step 1 when this input receives a gate trigger. See "[Triggering arpeggios](#)" for a tip on how this can be used. If something is connected to this input the RPG-8 will not generate arpeggios unless a Gate trigger is received.

Note: If you are modulating the arpeggio using the CV Input jacks, this will not affect the rendered arpeggio notes.

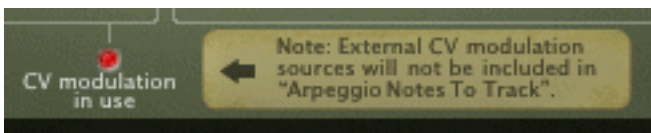

## CV Outputs

The following CV outputs are available:

- **Gate CV Out (Velocity) transmits a gate/velocity value that corresponds to the Velocity parameter setting.**  
This is normally auto-routed to the Sequencer Control Gate input on an instrument device.
- **Note CV Out transmits the notes generated by the Arpeggiator (or if this is off, the notes you input to the RPG-8).**  
This is normally auto-routed to the Sequencer Control CV input on an instrument device.
- **Mod Wheel/Pitch Bend Outputs will normally connect to the corresponding inputs of the instrument device controlled by RPG-8.**
- **The common MIDI performance controllers Aftertouch/Expression/Breath can be used to control any parameters using these CV outputs.**
- **Start of Arpeggio Trig Out - every time the arpeggio figures start over this output will send a gate signal.**  
This can be used to trigger filter, amp and mod envelopes in other devices, e.g. Subtractor. The length of this gate is the same as the length of the first note in the arpeggio.
- **Sustain Pedal Gate Out - the sustain pedal can be used to trigger envelopes in other devices.**  
If you plug a cable into the “Sustain Pedal Gate Out” the normal pedal to the Hold parameter connection is broken and the sustain pedal function is changed to send out a gate signal with velocity equalling the Velocity setting knob (if Manual mode is on then velocity defaults to a value of 100).

# Tips and tricks

## Using the RPG-8 for modulation

You can use the RPG-8 as a modulation source, much like an LFO. The RPG-8 can generate stepped modulation that is both synchronized to tempo and controlled by note input. In this and in following examples we assume you already have a RPG-8 connected to an instrument device.

→ **With the RPG-8 selected in the rack, create a Spider CV Merger/Splitter.**

The RPG-8 Note and Gate CV outputs are auto-routed to the Spider Split A and B inputs, and the Spider first split Note and Gate outputs are connected to the instrument device (as they were before creating the Spider).

You now have 2 (and 1 Inverted) additional Note and Gate CV outputs via the Spider.

→ **Try using the Note CV split outputs to modulate other parameters in the instrument device, e.g. filter frequency.**

The filter frequency will then track the notes generated by the Arpeggiator.

→ **You can of course also connect the Note CV out to various parameters in any device, not just the device connected to the RPG-8.**

→ **You can connect the Spider split CV/Gate outputs to the corresponding Sequencer Control CV inputs to another instrument device so that the RPG-8 controls two (or more) devices. (This can of course also be done by connecting the RPG-8 to a Combinator device.)**

## Triggering arpeggios

On the back panel there is a “Start of Arpeggio Trig In” CV connector. This restarts the arpeggio figure from step 1 when this input receives a gate trigger. You could use this in the following way:

→ **One or more Redrum channels Gate out can reset the step pattern to create rhythmic patterns in sync.**

→ **You could use the Matrix in the same way - each positive Gate signal will restart the arpeggio figure.**

! **Note that no arpeggio will be generated unless a Gate trigger is received when something is plugged in to the “Start of Arpeggio Trig In” CV connector.**

## Triggering samples

The Gate CV output can be used to trigger samples, either in Redrum or Kong or in the NN-19 or NN-XT Sampler.

→ **Connect the RPG-8 Gate CV out to the Gate (Sequencer Control) in on the NN-19/NN-XT or to one of the individual Gate Channel inputs of Kong or Redrum.**

Gate values will now trigger the sample on each step with Gate values above “0”.

## Using the RPG-8 as a MIDI to CV converter

You can also use the RPG-8 as a stand-alone MIDI to CV converter without generating arpeggios. In this mode (Arpeggiator Off) you can play instrument devices just like as if MIDI input was directly connected to the target device.

The main benefit of this mode is that you can use note pitch and velocity to control parameters, not only in the target device but in any device.

# **Chapter 50**

## **ReBirth Input Machine**

# Information about ReBirth Input Machine

**!** The ReBirth Input Machine is a device for receiving audio via ReWire from the Propellerhead “ReBirth RB-338” program (version 2.01 and later). Since the ReBirth RB-338 program is no longer supported, and doesn’t work under 64-bit Windows operating systems, the ReBirth Input Machine does not work anymore. The only reason it is still available is that you might have old Reason songs that contain the ReBirth Input Machine.



**Chapter 51**  
**Menu and Dialog**  
**Reference**

# Reason menu (Mac OS X)

## About Reason...

This menu item opens up a dialog that informs you about the version of the program and the people behind it.

## Preferences...

This menu item opens up the Preferences dialog. See “[Preferences – General](#)”, “[Preferences – Audio](#)”, “[Preferences – Control Surfaces](#)”, “[Preferences - Sync](#)”, “[Preferences – Advanced](#)” and “[Preferences - Language \(Windows only\)](#)” for detailed descriptions about the functions and settings in this dialog.

## Your Profile...

This menu item launches your default web browser and brings you to your Profile page on Propellerhead. There you can log in, make settings and manage your music.

## Check for Updates...

This checks for recent Reason updates on the Propellerhead server.

## Services

The Reason menu contains the standard Mac OS X Services item. Please consult the Macintosh Help for descriptions about these.

## Show/Hide

These are the standard Mac OS X Hide/Show options which lets you choose what to view.

## Quit Reason

This allows you to quit the program. If there are any documents open with unsaved changes you will be asked whether you want to save those changes before quitting.

# File menu

## New

When you select this, a new song appears. The exact contents of this song is determined by your Preferences settings (see [“Default Song”](#)).

## New from Template

On the sub-menu you can create a new song based on the selected Template Song. The selected Template Song appears in a new document window.

On Windows platforms, the document will be named “Document n” where “n” is an incremental number.

On Mac OS X platforms, the document will be named “untitled n” where “n” is an incremental number.

You can then save your song with a new name. See [“Creating a new Song from a template”](#) for more details.

## Open...

**! The “Open...” item is only available if you run Reason in Authorized Mode (see [“Registering Reason”](#)).**

To open a Song, proceed as follows:

**1. Pull down the File menu and select Open.**

The Reason Browser appears (if hidden).

**2. Navigate to the desired folder on disk or within a ReFill.**

**3. When you have located the song file, select it and click Open in the Browser (or double click the file).**

The song appears in its own document window.

- **You can have several songs open at the same time if you like. This allows you to copy and paste audio, note and automation clips, tracks, devices, mixer channels and patches between songs. However, all open songs consume some memory and performance, so you may want to close songs you don't need.**

See [“Opening a Reason or Record Song”](#) for more details.

## Open Demo Song

**! The “Open Demo Song” item replaces the “Open...” item if you run Reason in Demo Mode (see [“Running Reason in Demo Mode”](#)).**

**→ Choose the Demo Song to open by selecting it from the sub-menu that appears.**

The song appears in its own document window.

See [“Opening a Reason Demo Song”](#) for more information.

## Close

**→ Select “Close” to close the active window.**

If the window is a song document window and has unsaved changes, you will be asked whether you want to save those changes.

Closing the last open song document window will quit Reason (Windows only).

## Save

This saves the active song document to disk.

- **If the song document hasn't yet been saved, the "Save As" dialog appears, requesting you to enter a file name and specify a location for the file on disk (see "Save As...").**
- **If the document has already been saved at least once, the document will simply be saved without any questions.**

## Save As...

This saves the active song document to disc. A standard Save As dialog appears requesting you to enter a file name and specify a location for the file on disk. The "Save As" command will also automatically optimize the song file size when applicable (see "Save and Optimize").

- **You can set things up so that any samples used in the song are included in the song file itself by specifying self-contained settings (see "About Self-Contained Songs").**

## Save and Optimize

When you record audio in the sequencer, the recordings are stored in your song document. If you remove recordings in your song, there might be "empty" areas left in the document, similar to a fragmented hard disk. To "defragment" the song document, and thus reduce the file size, you can use the "Save and Optimize" command.

See "Saving and optimizing a Song" for more details.

## Song Information...

This brings up a dialog that allows you to add contact information and comments etc. about your song.

See "Including Song Information" for information.

## Song Self-contain Settings...

If you want to open your song on another computer, or send it to another Reason user, you would also have to bring all samples and REX files used by the Reason devices in the Song. To make this easier, Reason allows you to create "self-contained" songs. A self-contained song contains not only the references to the used samples and REX files, but also the files themselves. By selecting the "Song Self-Contain Settings", you can choose what files to include in your song.

See "About Self-Contained Songs" for more information.

## Import Audio File...

Selecting "Import Audio File..." opens the Browser (if hidden), which displays compatible audio files. Select audio files to import to audio tracks in Reason.

See "Importing audio to the sequencer" for more information.

## Import MIDI File...

Reason can import standard MIDI files (SMF). This allows you to import MIDI data to Reason from other applications. Selecting "Import MIDI Files..." opens the Browser (if hidden), which displays compatible MIDI files. Select MIDI files to import to ID8 tracks in Reason.

See "Importing Standard MIDI Files" for more information.

## Export MIDI File...

Reason can export standard MIDI files (SMF). Selecting “Export MIDI Files...” brings up the Export MIDI File dialog from which you can export all instrument tracks and automation tracks from the Reason sequencer as a Standard MIDI File (SMF).

See “[Exporting Standard MIDI Files](#)” for more information.

## Export Insert FX Patch...

This item is available for a selected Audio Track device, Mix Channel device or their corresponding channel strips in the Main Mixer. Selecting “Export Insert FX Patch” brings up the Save Insert FX Patch dialog from which you can save the Insert FX patch used in the selected Audio Track/Mix Channel device as a Combinator (\*.cmb) Patch File.

## Save Device Patch As...

This item is available for a selected device that can save patches. The menu item name reflects the type of device selected (for example “Save Combinator Patch As...”).

Even though the device settings are stored in the song, you may want to save any settings you have made for a device as a separate patch file. This allows you to use the patch in other songs, and lets you try out other patches in your song without risking to lose your original sound.

- **The different types of patch files have different file extensions.**

These are:

“.cmb” (Combinator patch files)

“.zyp” (Subtractor patch files)

“.thor” (Thor patch files)

“.xwv” (Malström patch files)

“.smp” (NN-19 patch files)

“.sxt” (NN-XT patch files)

“.drp” (Redrum patch files)

“.drex” (Dr. Octo Rex patch files)

“.drum” (Kong drum patch files)

“.kong” (Kong kit patch files)

“.rv7” (RV7000 patch files)

“.sm4” (Scream 4 patch files)

“.l6t” (Line 6 Amp Tone)

“.pulver” (Pulveriser patch files)

“.gator” (Alligator patch files)

“.echo” (The Echo patch files)

“.repatch” (Rack Extension patch files)

- **If you have selected a patch, modified it and want to save it with the modifications, you could either save a separate, modified version of the patch (with a new name) or simply overwrite the old patch file on disk.**

As usual, you will be asked whether you really want to replace the existing patch file.

– **You can also save a patch by clicking the floppy disk button on the device panel.**

- You can save a patch under the same name and location (without having the save dialog appear) by holding down [Alt](Win) or [Option](Mac) and clicking the floppy disk button on the device panel. Note that this overwrites the original patch!

## Export Song/Loop as Audio File...

When you have created a complete song, you will want to mix it down to a WAV or AIFF audio file to make it playable for other people (who don't use Reason). You can either export the whole song, or only the loop (the region between the left and right locator in the sequencer).

See ["Exporting Songs or parts of Songs"](#) for more information.

## Bounce Mixer Channels...

Bouncing Mixer Channels basically means "recording" the audio outputs from individual Audio Track Channels and/or Mix Channels to audio files. The audio files can then be saved to disk or placed on new Audio Tracks in your song.

See ["Bouncing Mixer Channels"](#) for information on how to bounce mixer channels.

## Drop to Propellerhead...

The Drop to Propellerhead function lets you export a song, or part of a song (loop), in a proprietary Propellerhead format and automatically upload it to your Propellerhead account. The dropped (uploaded) audio can then be imported into other applications, such as the Propellerhead Take iOS app, and you can also share your exported files with others if you like.

See ["Drop to Propellerhead"](#) for more information.

## Export REX as MIDI File...

This item is only available if a Dr. Octo Rex device is selected in the rack. If you have loaded a REX file into a Dr. Octo Rex device and wish to play back the loop via MIDI (typically from another sequencer), proceed as follows:

1. **Select the Dr. Octo Rex device in the rack.**
2. **Select "Export REX as MIDI File..." from the File menu.**
3. **Save the MIDI File to disk.**
4. **In the other application, open the MIDI file you just created.**
5. **Set up the other application to play back the MIDI File on the correct MIDI Output and MIDI Channel (the output and channel on which the Dr. Octo Rex device receives data).**

## Recent Songs list

Here is a list of the eight most recently opened Reason Songs. Select any of these songs to open them in new, separate document windows.

## Exit (Windows)

This allows you to quit and exit the program. If there are any song documents open with unsaved changes you will be asked whether you want to save those changes before quitting.

# Edit menu

## Undo

Virtually any actions in Reason can be undone. This includes creation, deletion and reordering of devices in the rack, parameter value adjustments, recording and editing in the sequencer and tempo/time signature adjustments. You can undo hundreds of actions.

! **Sequencer Transport commands are not “undoable”.**

→ **To undo the latest action, select “Undo” from the Edit menu or hold [Ctrl](Win) or [Cmd](Mac) and press [Z].**

The action to be undone is indicated next to the Undo command on the Edit menu. For example, if your latest action was to delete some device(s) from the rack, the Edit menu will say “Undo Delete Devices”.

See “Undo and Redo” for more detailed information.

## Redo

→ **To redo an undone action (“undo the undo operation”), select “Redo” from the Edit menu or hold [Ctrl](Win) or [Cmd](Mac) and press [Y].**

The action to be redone is indicated next to the Redo command on the Edit menu. You can undo/redo hundreds of actions.

See “Undo and Redo” for more detailed information.

## Cut/Cut Tracks and Devices/Cut Channels and Tracks

This command takes the selected item(s), removes them and places them on the clipboard (an invisible storage location) from where they can later be pasted in.

Cutting applies to devices/channels and their sequencer tracks, sequencer clips, notes and automation points.

! **If “Auto-group Devices and Tracks” is selected in the Options menu, all devices in the Device Group will be cut - see “About Device Groups”.**

## Copy/Copy Tracks and Devices/Copy Channels and Tracks/Copy Patch

This command takes the selected item(s), copies them and places the copies on the clipboard (an invisible storage location) from where they can later be pasted in.

Copying applies to devices/channels and their sequencer tracks, sequencer clips, notes, automation points and device patches. Also individual Kong Drum patches can be copied and pasted from one selected pad to another.

! **If “Auto-group Devices and Tracks” is selected in the Options menu, all devices in the Device Group will be copied - see “About Device Groups”.**

## Paste/Paste Tracks and Devices/Paste Channels and Tracks/Paste Patch

This command takes the items that you have cut or copied to the clipboard and pastes them back into the document.

• **When you paste a sequencer track, its device will be pasted at the same time (and vice versa, if the device has a track).**

Pasted tracks and devices are inserted below the currently selected track in the track list and below the selected device in the rack, respectively.

! **If “Auto-group Devices and Tracks” is selected in the Options menu, all devices in the Device Group will be pasted - see “About Device Groups”.**

If nothing is selected, the pasted items will appear at the bottom of the track list/rack.

- **If you copy and paste several devices, the connections between these are preserved.**
- **If you hold down [Shift] when you paste a device, Reason will attempt to auto-route it.**  
For example, [Shift]-pasting an instrument device typically connects it to the first free Mix Channel device input(s) above it in the rack.
- **You can also paste the device(s), channel(s) and track(s) into another song, including all sequencer data and device settings.**
- **When you paste sequencer clips, they appear at the song position, on their original track(s).**  
If you have deleted the original tracks, or if you paste into another Reason song document, the clip will be pasted at the song position on the selected track (if the track type is the same as the original). Otherwise new tracks will be created. If the clip is a note clip, a new ID8 instrument track will be created.
- **Notes or automation points will be pasted at the song position on the selected track (if the track types are compatible).**
- **Individual Kong Drum patches can be copied and pasted from one selected pad to another.**

## Delete/Delete Tracks and Devices/Delete Channels and Tracks

This menu item is used for deleting selected items. If you delete a sequencer track with this menu item (then called "Delete Tracks and Devices"), its device is also deleted.

! **If "Auto-group Devices and Tracks" is selected in the Options menu, an alert appears asking you if you want to delete only the selected device or the entire Device Group - see "About Device Groups".**

### Delete Tracks

This deletes the currently selected sequencer track(s) without removing the corresponding rack device(s) or mixer channels.

### Duplicate Tracks and Devices/Duplicate Channels and Tracks

This creates a duplicate of the selected device and track, or channel and track, complete with all parameters and recordings/events. The duplicated items will appear below the selected device and track, respectively.

! **If "Auto-group Devices and Tracks" is selected in the Options menu, all devices in the Device Group will be duplicated - see "About Device Groups".**

### Select All/Select All Devices/Select All Tracks/Select All Channels

This selects all devices in the rack, all tracks in the track list, all channels in the Main Mixer, or all clips or all notes or automation points in an open clip. The result depends on which area (rack, track list, Main Mixer etc.) has focus. This is indicated by a thin frame around an area in the document window.

→ **To set focus to the desired area, click somewhere in it.**

You can use this menu item to quickly apply a command to all items you are working on, for example deleting all devices in the rack (select Select All Devices and then press [Delete]) or for Quantizing all notes in an open clip (select Select All and then click the Quantize button in the Tool window).

### Select All in Device Group

This will select all devices within the selected device's Device Group. See "About selecting all devices in a Device Group".



## Sort Selected Device Groups

This function should be used if you want to rearrange devices, channel strips or sequencer tracks according to the order of the current selection. For example, if you want to rearrange the rack devices according to the current sequencer track order, you can select all sequencer tracks and then choose “Sort Selected Device Groups” to rearrange the rack devices. See [“About the “Sort Selected Device Groups” function”](#) for more examples.

## Auto-route Device

Auto-routing is when devices' audio and CV/gate connections are automatically routed according to default rules. Auto-routing is normally performed when:

- **A new device is created.**
- **Moving, duplicating or pasting devices with [Shift] pressed.**

However, if a device is already in the rack, you can “force” it to be auto-routed by selecting it and then select this menu item.

For more information about auto-routing rules, see [“Automatic routing”](#).

## Disconnect Device

This disconnects all audio and CV/gate connections from the selected device(s).

## Combine/Uncombine

- **By selecting several devices in the rack and selecting “Combine”, a Combinator device will be created containing the selected devices.**
- **By selecting the Combinator (or one or several devices contained in a Combinator) and then selecting “Uncombine” will remove the devices from the Combinator and into the rack.**

In case the whole Combinator is selected, this will be removed and the devices it contains will be moved into the rack.

See [“The Combinator”](#) for more details.

## Copy/Paste Channel Settings (Main Mixer channel strips)

This function allows you to copy and paste the parameters of different sections of a Main Mixer channel strip and paste into another channel strip. The available parameter groups are:

- **Dynamics**
- **Filters and EQ**
- **Insert FX**  
This will copy the entire Effect Combi patch (with all Combinator devices included)
- **FX Sends**  
This will only copy the FX Send parameters in the channel strip - not any FX devices or patches.
- **All**  
This will copy all channel strip parameters, including any Insert FX devices.

## Route to (Main Mixer channel strips)

This allows you to create, and automatically route, one or several selected Main Mixer channel strips to a new or existing Output Bus for sub-mixing purposes. See [“Creating an Output Bus”](#).

## Create Parallel Channel (Main Mixer channel strips)

This allows you to create a parallel mixer channel for parallel processing purposes. See [“Creating Parallel Channels”](#).

## Clear Insert FX

This disconnects and removes all Insert FX devices of a selected Mix Channel or Audio Track device in the rack, or of a selected channel in the Main Mixer. See [“Deleting Insert effects”](#) for more details.

## Reset All Channel Settings (Main Mixer channel strips)

This will reset all channel strip parameters to their default values. Any Insert FX Combinator patches will be removed.

## Reset Device

Sometimes it is useful to start with a “clean slate” when creating a sound or effect. This is done by selecting Reset Device from the device context menu or Edit menu. This sets all parameters to their default values. Resetting NN-19, NN-XT, Dr. Octo Rex, Redrum or Kong devices also removes samples from the device, allowing you to start from scratch.

## Cut Pattern

Moves the current pattern in the selected Redrum or Matrix to the clipboard. The pattern is then cleared.

## Copy Pattern

Copies the current pattern in the selected Redrum or Matrix to the clipboard.

## Paste Pattern

Copies the pattern on the clipboard to the current pattern location in the selected Redrum or Matrix device. This overwrites the current pattern with the one on the clipboard. Note that this can be used to transfer patterns between different Reason songs.

## Clear Pattern

This menu item clears (empties) the current pattern on the selected pattern device (Redrum or Matrix).

## Browse Patches.../Browse Insert FX Patches...

This menu item allows you to select a new Patch for a device or an Insert FX Patch for a selected channel strip. The menu item reflects which device is selected - in other words, you must select the device for the corresponding Browse Patches item to appear on the Edit menu.

When you select the menu item, the Browser appears (if hidden), allowing you to locate and select the patch, on disk or within a ReFill.

When you load a patch, the device's parameters will be set according to the values stored in the patch, and the name of the patch will be shown in the patch name display. As with any change you make, this operation can be undone.

**! Any parameter adjustments you make on the device panel after selecting a patch will not affect the actual patch file (for this you need to re-save the patch).**

- **If referenced samples are missing**

Patches for the Redrum, Combinator (if any sampler devices are part of the Combi), NN-19, NN-XT Kong and Dr. Octo Rex devices contain references to samples. Just like patches, samples can be independent files on the hard disk or elements within a ReFill or a SoundFont. However, if sample files have been moved or renamed after a patch was saved, the sample file references in the patch will not be accurate.

If this is the case when you select a patch, the program will tell you so. You can then choose to either manually locate the missing files, to have the program search for them in all stored locations and ReFills or to proceed without the missing sounds.

## Browse Loops...

This menu item is used to add a loop to the selected Dr. Octo Rex Loop Slot. Files to be imported can be in REX, RCY or RX2 file format.

Loading a new REX file will replace any currently loaded file in the selected Loop Slot.

## Browse Samples...

This menu item lets you load samples into the devices that use them; the Redrum, the NN19, the NN-XT and the NN-Nano drum module in Kong. The following sample formats can be loaded:

- **In Windows 7:**  
.wav, .aif, .mp3, .aac, .m4a and .wma.
- **In Mac OSX 10.7:**  
.wav, .aiff, .3g2, .3gp, .mp1, .mp2, .mp3, .mpeg, .mpa, .snd, .au, .sd2, .ac3, .aac, .adts, .amr, .caf, .m4a .m4r and .mp4.
- **SoundFonts (.sf2)**  
SoundFonts are an open standard for wavetable synthesized audio, developed by E-mu systems and Creative Technologies.
- **REX file slices (.rx2, .rex, .rcy)**  
REX files are music loops created in the ReCycle program or when editing audio clips inline in Reason (see [“Bounce Clip to REX Loop”](#)). The NN19 and NN-XT let you load REX files either as complete patches or individual REX slices as separate samples. The NN-Nano lets you load separate slices from REX files as individual samples.
- **Any sample rate and practically any bit depth.**

Redrum:

To use this menu item to load a new drum sound into Redrum, proceed as follows:

- 1. Select a channel in the drum machine, by clicking its Select button.**
- 2. Select Browse Samples.**  
The Redrum channel gets Browser focus and displays compatible files.
- 3. Navigate to a location containing any of the sample formats listed above, select one and click Load.**

NN19:

This menu item can also be used to add a sample to a key zone in a key map in the NN19 sampler.

- 1. Select a key zone.**  
This can be empty, or contain a sample - it doesn't matter for now.
- 2. Use the Browser to add one or several (see below) sample(s).**

The following will happen:

- **If the zone contained a sample prior to loading, this will be replaced, both in the zone and in the sample memory, unless the sample was also used by another key zone.**
- **If you loaded several samples, one of the samples (the sample that was selected furthest down in the Browser list) will be loaded into the key zone, and the other samples will be loaded into the sample memory.**

NN-XT:

This menu item is used for adding one or more sample(s) to a key zone in the NN-XT:

- 1. Make sure the Remote Editor panel is folded out, by clicking the small arrow in the bottom left corner.**

If the remote editor panel is folded in, you will only be able to browse for NN-XT *patches*.

- 2. Use the Browser to add one or several sample(s).**

The sample(s) will be placed in separate zones and mapped across the same key range.

- **If a zone is selected when you browse for samples, the sample will be loaded into that zone, replacing any previous sample.**

Replacing samples this way is only possible when you load a single sample.

## Automap Samples

This menu item applies to the NN19 Sampler. If you have a number of samples that belong together but haven't been mapped to key zones, you can use the "Automap Samples" function. This is used in the following way:

- 1. Select all samples that belong together and load them in one go, using the sample browser.**

One of the samples will be loaded to a key zone spanning the whole range, and the rest will reside in the sample memory.

- 2. Select Automap Samples from the Edit menu.**

Now the samples currently in memory will be arranged automatically so that:

- **Each sample will be placed correctly according to its root note, and will be tuned according to the information in the sample file.**

Most audio editing programs can save root key information as part of the file.

- **Each sample will occupy half the note range to the next sample's root note.**

The root key will always be in the middle of each zone, with the zone extending both down and up in relation to the root position. Hence, no key zone high or low limits have to be manually set!

Mapping Samples Without Root Key or Tuning Information:

Some samples may not have any information about root key or tuning stored in the file (nor indicated in the file name). If this is the case, you can still make use of the Automap function:

- 1. Select all samples that belong together and load them in one go, using the sample browser.**

One of the samples will be loaded to a key zone spanning the whole range, and the rest will reside in the sample memory.

- 2. Manually set the root key, and adjust the tune knob if the sample needs pitch fine-tuning.**

Without any information stored in the file, or if the file name doesn't indicate the root key, you will have to use your ears for this step. Play the sample across different areas of the keyboard and listen to where it sounds the most "natural". As long as you are in the general area of the correct root key, the result should be o.k. You can always adjust this later.

- 3. Select the next sample using the Sample knob, and repeat the previous step.**

Proceed like this until you have set a root key for all the samples.

- 4. Select "Automap Samples" from the edit menu.**

The samples will be automatically mapped according to their set root key positions!

## Delete Sample/Remove Sample

Redrum:

- **To remove a sample from a Redrum drum machine, select its drum sound channel and then select “Delete Sample” from the Edit menu.**

The sample is removed from the drum sound channel and from sample memory.

NN19:

- **To remove a sample from an NN19 Sampler’s memory, select the zone it belongs to, and then select “Delete Sample” from the Edit menu.**

The sample is removed from the zone and from sample memory.

NN-XT:

- **To remove a sample from an NN-XT Sampler’s memory, select the zone it belongs to, and then select “Remove Samples” from the Edit menu.**

The sample is removed from the zone and from sample memory. The zone still remains though. To delete a zone, you must use the option “Delete Zones”.

## Delete Unused Samples

This menu item is used for the NN19 Sampler. When you select it, all samples that are not assigned to a key zone are deleted from sampler memory.

This way you can make sure that you are not wasting any sample memory for samples that are not actually used.

## Split Key Zone

This menu item is used for the NN19 Sampler. It splits the currently selected key zone in the middle. The new zone is the upper half of the split, and is empty. The dividing point has a “handle” above it.

## Delete Key Zone

This menu item is used for the NN19 Sampler. It deletes the currently selected key zone from the key map.

## Reload Samples

This menu item is used with the NN-XT sampler. When you select this, any changes you have made on a loaded sample using the sample parameters (root key, loop settings, etc.) are immediately undone, and the settings revert back to the original.

## Add Zone

This menu item is used with the NN-XT sampler. It is used for adding an empty zone to the key map. An empty zone can be resized, moved and edited in the same way as zones that contain samples.

An empty zone is indicated with the text “\*\*No Sample\*\*”. After you have added an empty zone, you can assign a sample to it.

## Copy Zones

This menu item is used with the NN-XT sampler. It copies the selected zone(s), and all of its settings - including references to any sample it may contain - and places it in the clipboard buffer. You can then select "Paste Zones" to create a new zone that is an exact replica of the copied zone(s). Note that copying/pasting zones can also be performed between separate NN-XT devices.

## Paste Zones

This menu item is used with the NN-XT sampler. If you have used the "Copy Zones" command, with any number of selected zones, you can create exact duplicates of these by using the "Paste Zones" command. The pasted zones will then be added below any existing zones in the key map.

## Duplicate Zones

This menu item is used with the NN-XT sampler. It lets you duplicate any number of already existing zones (containing samples or empty).

### 1. Select the zone(s) you want to copy.

### 2. Select "Duplicate Zones".

The selected zones will now be copied and automatically inserted below the last one in the key map display.

The duplicated zones will contain references to the same samples as the original zones. They will also have the exact same key ranges and parameter settings.

## Delete Zones

This menu item is used with the NN-XT sampler. Selecting this option will remove both the selected zones, and any samples they may contain.

## Select All Zones

This menu item is used with the NN-XT sampler. This option will automatically select all zones in a key map.

## Copy Parameters to Selected Zones

This menu item is used with the NN-XT sampler. It lets you easily copy parameter settings from one zone to any number of other zones. Proceed as follows:

### 1. Select all the zones you want to involve in the operation.

By this we mean the zone with the settings you wish to copy, and the zone(s) to which you want to copy the settings.

### 2. Make sure the zone that contains the settings you want to copy has edit focus by clicking on it.

Focus is indicated by a thick border.

### 3. Select "Copy Parameters to Selected Zones".

All the selected zones will now get the exact same parameter settings.

**! Observe that this only applies to the synth parameters (LFOs, envelopes etc.). Sample parameters (root key, velocity range etc.) can not be copied.**

## Sort Zones by Note

This menu item is used with the NN-XT sampler. This option lets you automatically sort the selected zones within a Group in descending order according to their key ranges. When you invoke this option, the selected zones will be sorted from top to bottom in the display starting with the one with the lowest range. If two or more zones have the same key range, they are instead sorted by velocity range.

## Sort Zones by Velocity

This menu item is used with the NN-XT sampler. This option lets you automatically sort the selected zones within a Group in descending order according to their set low or high velocity values.

When you invoke this option, the selected zones will be sorted from top to bottom starting with the one with the highest “Lo Vel” value.

If two or more zones have the same velocity range, they are instead sorted by key range.

## Group Selected Zones

This menu item is used with the NN-XT sampler. It lets you put any number of selected zones together in a group.

Grouping zones is good for two things:

→ **To allow you to quickly select a number of zones that “belong together.”**

For example if you have created a layered sound consisting of piano and strings, you could put all string samples in one group and all piano samples in one group. Then you can quickly select all piano samples and make an adjustment to them by trimming a parameter.

→ **To group zones that need to share group settings together.**

For example, you may want to set a group to legato and monophonic mode and add some portamento so that you can play a part where you slide between notes.

Proceed as follows:

**1. Select the zones you want to group together.**

The zones don't have to be contiguous in order to be grouped. Regardless of their original positions in the samples column, they will all be put together in succession.

**2. Select “Group Selected Zones”.**

The zones are grouped.

Note that there is always at least one group, since the zones you create are always grouped together by default.

## Set Root Notes from Pitch Detection

This menu item is used with the NN-XT sampler. All instrument sounds have an inherent pitch. When playing a sample of such a sound on the keyboard, the keys you play must correspond to that pitch. For example, you may have recorded a piano playing the key “C3”. When you map this onto the NN-XT key map, you must set things up so that the sampler plays back the sample at original pitch when you press the key C3, and this is done by adjusting the root note.

The NN-XT features a pitch detection function to help you set the root keys of loaded samples. This is useful if you for example load a sample that you haven't recorded yourself, and you don't have any information about its original pitch.

Proceed as follows:

**1. Select all the zones you want to be subject to pitch detection.**

**2. Select “Set Root Notes from Pitch Detection”.**

The samples in all the selected zones will now be analyzed, and the detected root keys will automatically be set for you.

**! Note that for this to work properly, the samples must have some form of perceivable pitch. If it is sampled speech, or a snare drum for example, it probably doesn't have any discernible pitch.**

## Automap Zones

This menu item is used with the NN-XT sampler. The automap function can be used as a quick way of creating a key map, or as a good starting point for further adjustments of a key map.

Automap works under the assumption that you intend to create a key map for a complete instrument, for example a number of samples of a piano, all at different pitches.

### 1. Load the samples you want to Automap.

Now you have three options:

- **Trust that the root note information in the files is already correct.**
- **Manually adjust the root notes (and tuning) for all the samples.**
- **Use "Set Root Notes from Pitch Detection" to automatically set up the root notes.**

### 2. Select all zones you want to automap.

### 3. Select Automap Zones.

All the selected zones will now be arranged automatically in the following way:

- **The zones will be sorted in the display (from top to bottom - lowest key first) according to the root keys.**
- **The zones will be assigned key ranges according to the root keys.**

The key ranges are set up so that the split between two zones is exactly in the middle between the zones' root notes. If two zones have the same root key they will be assigned the same key range.

## Automap Zones Chromatically

This menu item is used with the NN-XT sampler. It will map the selected zones chromatically (one zone per semitone) from C2 and up. This is useful if you are mapping non-pitched material (e.g. drum or percussion samples) and want one sample per key. Before you select Automap Zones Chromatically, you may want to adjust the order of the zones, since this determines which zone is mapped to which key.

## Create Velocity Crossfades

This menu item is used with the NN-XT sampler. This is used for automatically setting up velocity crossfades for smooth transitions between overlapping zones. To set up crossfades, you adjust the fade out and fade in values for the overlapping zones.

An example:

- **Two zones are both set to play in the full velocity range of 1-127.**
- **Zone 1 has a fade out value of 40.**

This means that this zone will play at full level with velocity values below 40, With higher velocity values, it will gradually fade out.
- **Zone 2 has a fade in value of 80.**

This has the effect that as you play velocity values up to 80, this zone will gradually fade in. With velocity values above 80, it will play at full level.

Instead of manually setting up a crossfade, you can let NN-XT do it for you. Proceed as follows:

- 1. Set up the zones so that their velocity ranges overlap, as desired.**
- 2. Select the zones.**

You can select as many zones as you wish, not just one pair of overlapping zones.



### 3. Select “Create Velocity Crossfades”.

NN-XT will analyze the overlapping zones and automatically set up what it deems to be appropriate fade in and fade out values for the zones.

Note the following important points:

- **This operation will not work if both zones have full velocity ranges.**  
At least one of the zones must have a partial velocity range (see “[Setting crossfading for a Zone](#)”).
- **This operation will not work if the zones are completely overlapping.**

## Copy Loop to Track

This menu item is used for the Dr. Octo Rex loop player device. To be able to make your REX loop start at the same time as other sequencer or pattern data, you “convert” the slices in the loop to note clips in the sequencer:

### 1. Select the sequencer track for the Dr.Rex device.

### 2. Set the locators to encompass the section you want to fill with REX clips.

You may want to make sure that this area doesn't contain any note clips already, to avoid overlapping clips.

### 3. Select desired Loop Slot in the Dr. Octo Rex player.

### 4. Pull down the Edit menu and select “Copy Loop to Track”.

Now, the program will create a note for each slice, positioned according to the timing of the slices. The notes will be laid out in semitone steps, with the first note on C1, the second on C#1 and so on, with one semitone for each slice. If the range between the locators is longer than the loop length, the loop notes will be repeated to fill out the loop.

Now you can reorder, overdub onto, and otherwise edit the note data on the edit lanes in the sequencer.

## Copy Pattern to Track

This menu item is used for the Redrum drum machine and Matrix pattern sequencer. It converts the selected pattern to notes on a sequencer track. Proceed as follows:

### 1. Select a sequencer track.

When working with a Redrum, you want to select the track for the Redrum device. For the Matrix, you would typically select the track for the Matrix' target device (the instrument device to which the Matrix is connected). This is because the Matrix itself produces no sound, so the notes won't do any good on the Matrix track.

### 2. Set the locators to the desired range or length.

If the range set is longer than the pattern(s), the data will be repeated to fit the range.

### 3. Select the pattern device.

### 4. Pull down the Edit menu and select “Copy Pattern to Track”.

Note clips will be created between the left and right locators, according to the selected pattern.

### ! When copying Matrix patterns, only the Gate and Keys values will be included!

- **If you copied a Redrum pattern, you may want to turn off the “Enable Pattern Section” before playing back the new track data.**

Otherwise, both the main sequencer and the pattern sequencer will play the drum sounds, simultaneously.

- **If you copied a Matrix pattern, you may want to disconnect the Matrix (or even remove it), to avoid having both the Matrix and the sequencer notes playing at the same time.**

- **If you have automated pattern changes for your pattern device, you can render all patterns to notes in one go, using the “Convert Pattern Track to Notes” menu item instead.**

See “[Convert Pattern Automation to Notes](#)”.

## Shift Pattern Left/Right

These menu items are used for Redrum, Matrix, Thor (called "Shift Sequencer Pattern Left/Right") and the RPG-8 Arpeggiator (when the Pattern editor is activated).

The Shift Pattern functions move the notes in a pattern one step to the left or right.

## Shift Drum Left/Right

These menu items are used for Redrum.

The Shift Drum functions move the notes for the selected instrument one step to the left or right.

## Shift Pattern Up/Down

These menu items are used for the Matrix.

The Shift Pattern functions will transpose all the notes in a pattern one semitone up or down.

**! This function does not alter the Curve CV.**

## Random Sequencer Pattern

This menu item is used for the Thor synthesizer. It will assign random values to the pattern sequencer steps, but only for the property selected with the Edit knob. For example, if "Note" is the edited property, only the note pitches will be randomized; leaving velocity values, lengths, durations and curves intact.

- **Randomized note pitches will be kept within the range set with the Octave switch.**
- **The "Steps" setting (pattern length) will not be changed by randomizing.**
- **Steps outside the current pattern length will not be affected.**

## Randomize Pattern

This menu item is used for the Redrum, Matrix and RPG-8 Arpeggiator (when the Pattern editor is activated).

The Randomize Pattern function create random patterns. These can often be great starting points and help you get new ideas.

**! Note that for the Matrix, Randomize affects both the Gate, Note and Curve CV!**

## Randomize Drum

The Randomize Drum functions creates random patterns for the selected drum sound channel in the Redrum drum machine.

## Alter Pattern

This menu item is used for the Redrum, Matrix and RPG-8 Arpeggiator (when the Pattern editor is activated).

The Alter Pattern function modifies existing patterns. Note that there must be something in the pattern for the function to work on - using an Alter function on an empty pattern will not do anything.

**! Note that for the Matrix, Alter affects both the Gate, Note and Curve CV!**

## Alter Drum

This function modifies existing patterns for the selected drum sound in Redrum. Note that there must be something in the pattern for that channel for the function to work - using an Alter function on an empty pattern will not do anything.

## Invert Pattern

This menu item is used for the RPG-8 Arpeggiator device, when the Pattern editor is activated. This inverts the pattern, so that active steps become rests and vice versa.

## Arpeggio Notes to Track

This menu item is used for rendering the arpeggio from an RPG-8 to actual note clips. For this to work, you must have recorded chords or notes on the RPG-8 track and set the locators (so that an arpeggio is generated when you start playback from the left locator).

“Arpeggio Notes to Track” will create a note clip between the locators on the selected track, containing the generated arpeggio notes. You can then mute the original note clip(s) on the RPG-8 track and edit the rendered arpeggio notes as usual.

## Create Track for.../Delete Track for...

A rack device can have one sequencer track or no sequencer track. Instrument devices are by default created together with a sequencer track, while effect devices, mixers etc. are created without tracks.

- **If a device without sequencer track is selected, this menu item is called “Create Track for [device name]”.**  
Select it to create an empty sequencer track for the device.
- **If the selected device has a sequencer track already, this menu item is called “Delete Track for [device name]”.**  
It will remove the sequencer track and all its contents, but leave the device.

## Go To Track for

- **With a device selected in the rack, select “Go To Track for [device name]” to bring the corresponding sequencer track for the device into view.**

## Insert Bars Between Locators

**! The sequencer must have edit focus for this item to become available.**

This function inserts an empty area between the locators in the main sequencer. All events after the left locator are moved to the right to “make room” for the inserted area. See [“Inserting bars”](#) for more information.

## Remove Bars Between Locators

**! The sequencer must have edit focus for this item to become available.**

This function removes all material between the locators in the main sequencer. All events after the right locator are moved to the left to “fill out” the gap after the removed section. See [“Removing bars”](#) for more information.

## Stretch and Transpose Type

This function allows you to choose which Stretch and Transpose Type to use for a selected Audio Track. See [“Selecting Stretch and Transpose Type”](#) for more information.

## Bounce Clip to New Sample (Audio Clips)

It's possible to bounce an Audio Clip to a new Song Sample. You could then edit the sample in the Edit Sample window and then load into a sampler device for playback. See [“Bounce Clip\(s\) to New Sample\(s\)”](#).

## Bounce Clip to Disk (Audio Clips)

This function allows you to export a selected audio clip as a WAV or AIFF file to disk. See [“The “Bounce Clip to Disk” function”](#).

## Bounce Clip to New Recording (Audio Clips)

This function allows you to export the recording of a selected audio clip to an additional Comp Row. See [“Bounce Clip\(s\) to New Recording\(s\)”](#).

## Bounce Clip to REX Loop (Single Take Audio Clips)

This lets you bounce an open Single Take audio clip to a Rex file. The Rex file ends up on the Song Samples tab in the Tool Window. See [“Bounce Clip to REX Loop”](#).

## Revert Slices (Single Take Audio Clips)

This lets you undo all Slice Marker edits you made in an open Single Take audio clip and revert to the clip the way it was before you edited it. See [“Revert Slices”](#).

## Enable/Disable Stretch (Audio Clips)

This function lets you decide if a selected audio clip should stretch and follow tempo changes in the song. When disabled, the audio clip doesn't follow the song tempo. When enabled, the audio clip is stretched and follows the song tempo of the sequencer. See [“About tempo changes and tempo automation of audio tracks”](#).

## Delete Unused Recordings (Audio Clips)

This function deletes all recordings that are not used in the selected clip - or anywhere else in the song. By using this function, the file size of the song can be reduced. See [“Delete Unused Recordings”](#).

## Heal Clip Safe Clips (Audio Clips)

This function heals all selected audio clips that are affected by the Clip Safe function in the Propellerhead Balance audio interface. See [“Recording using the Clip Safe function in Propellerhead Balance”](#).

**! This function is only available when recording audio using the Propellerhead Balance audio interface!**

## Delete Clip Safe Audio (Audio Clips)

This function deletes the Clip Safe signal from selected audio clips. The clips revert to being ordinary clips (no clipped waveform indication, and no healing button). See [“Recording using the Clip Safe function in Propellerhead Balance”](#).

**! This function is only available when recording audio using the Propellerhead Balance audio interface!**

## Normalize Clips (Audio Clips)

This function increases the overall audio level of selected Audio Clip(s) so that the loudest peak touches 0 dB. See [“Normalizing Clips”](#).

## Reverse Clips (Audio Clips)

This function reverses selected Audio Clip(s) and plays them back backwards, from the end to the start. See [“Reversing Clips”](#).

## Split At Slices (Single Take Audio Clips)

This lets you split an open Single Take audio clip at the selected Slice Markers, and thus create several separate audio clips out of a bigger one. See ["Split at Slices"](#).

## Convert Pattern Automation to Notes

If you have recorded or drawn pattern changes on a Redrum or Matrix track, you can have the whole track converted to notes, in the following way:

**1. Select the track with the pattern changes.**

**2. Select "Convert Pattern Automation to Notes" from the Edit menu or the context menu for the track.**

For each pattern clip, the corresponding pattern is converted to note clips on the track (following the same rules as for the "Copy Pattern to Track" function). The track will play back just the same as when you played the pattern device with the pattern changes.

→ **After the operation, the Pattern Select lane is switched off.**

"Enable Pattern Section" (Redrum) and the Pattern Enable switch (Matrix) are automatically turned off.

→ **When you use this with a Matrix, you need to move the note clips to the track of an instrument device (typically the device to which the Matrix is connected).**

This is because the Matrix doesn't make any sound itself.

## Convert Block Track to Song Clips

This item is available only when the Blocks Track is on. Selecting this item will convert all Block Automation Clips on the Block Track to regular clips on the respective tracks and lanes in the song.

## Commit to Groove

This function is available if the track list has focus and one or several note lanes on the selected track have ReGroove Mixer channels assigned.

Commit to Groove will move all notes (on all note lanes on the selected track) to their grooved positions and then reset the groove settings to "No Channel" for the note lanes. In other words, this makes the groove "permanent" - the track will play back exactly as before, but you can now view and edit the grooved notes.

## New Note Lane

Adds a new note lane to the selected track(s). This is the same as clicking the "+ Lanes" button above the track list.

## Merge Note Lanes on Tracks

If there is more than one note lane on the selected track, this menu item will merge all note clips on all lanes into a single lane.

→ **If there are several clips containing the same performance controllers (e.g. mod wheel) on the same positions in the song, only the performance controller data from the topmost lane will be kept.**

This is the same rule as during playback - performance control data in the topmost lane has priority.

## Get Groove From Clip

This requires that a single note clip is selected. The function will look at the notes in the clip and extract a groove from these. You can apply this groove to other note lanes or save it as a groove patch for later use.

**1. Create or record a rhythmic note "pattern" of some kind.**

You may for example record a drum pattern, or use the notes playing the slices in a REX loop.

- For the groove to be useful in most common music styles, it's recommended that the note clip is an exact number of bars in length - preferably 1, 2, 4 or maybe 8 bars.
2. **Open the ReGroove Mixer from the transport panel and select a channel for editing (by clicking its Edit button).**  
This is where your custom groove will end up - choose an unused channel if you don't specifically want to replace a groove.
  3. **With the note clip selected, select "Get Groove From Clip" from the Edit menu or sequencer context menu.**  
The groove is assigned to the ReGroove Mixer channel as "User". By selecting that ReGroove Mixer channel for other note lanes, you can make the music fit with your custom groove.
  4. **Select the Groove tab in the Tool window.**  
Here you can adjust how the groove should affect note timing, velocity and length and also save the groove as a ReGroove Patch (including the settings of the sliders in the window).

Read more in ["The ReGroove Mixer"](#).

## Join Clips

This requires that more than one clip is selected on the same lane. Join Clips will join the selected clips together.

- ! **If note or automation clips contain masked-out events in the range between the clips, these events will be deleted. Also, if note or automation clips overlap, any hidden events are deleted - see ["Joining clips"](#).**
- **If joined audio clips contain masked recordings, these will not be deleted but moved and masked on a new Comp Row - see ["About joining audio clips"](#).**

## Mute Clips/Unmute Clips

If there are one or several unmuted clips selected, this menu item is called "Mute Clips". Muted clips (shown with angled stripes and dimmed borders) will not play back but can be edited and arranged as usual.

If only muted clips are selected, the menu item is called "Unmute Clips". The keyboard shortcut for Mute/Unmute Clips is [M].

## Crop Events to Clips

Notes or automation events can be positioned outside the start or end of a clip. For example, this would happen if you have resized a clip after recording. Notes outside the clip become masked and won't be heard on playback, but you can view and edit them if you open the clip.

Selecting "Crop Events To Clips" removes all such outside events from the selected clip(s). If tracks are selected in the track list, this function is performed on all clips on the selected track(s). See ["About masked recordings and events"](#) for more details.

## Add Labels to Clips/Remove Labels from Clips

This allows you to name the selected clips.

- **Clips with name labels (and their lanes) are shown slightly taller, to make room for the labels.**
- **If you select "Add Labels to Clips" with a single clip selected, this adds an "untitled" label and opens a text box for editing the label.**  
If you have several clips selected, the "untitled" label will be added to all selected clips. To edit the names of the clips, you need to double click each label.
- **If all selected clips have labels already, the menu item is called "Remove Labels from Clips".**

See ["Naming clips"](#) for more information.

## Clip Color

Allows you to select a color for the selected clip(s). See [“Coloring clips”](#) for more details.

## Channel Color

Allows you to select a color for the selected channel(s) and track(s). The selected color is shown in the track list and will be assigned to all new clips you create on the track. However, clips that are already on the track will not be affected - to change color of existing clips, select the clips and use the “Clip Color” setting.

- If **“Auto-color New Sequencer Tracks”** is activated on the Options menu, tracks will get colors assigned automatically when they are created.

See [“Coloring tracks”](#).

## Set Loop to Selection

This command sets the Left and Right Loop Locators to encompass all selected clips in the arrangement.

## Set Loop to Selection and Start Playback

This command sets the Left and Right Loop Locators to encompass all selected clips in the arrangement. Then, sequencer playback is automatically started in Loop Mode. This function also has a keyboard shortcut: press [P].

## Adjust Alien Clips to Lane

If an automation clip has been moved to a lane for a parameter with a different range (for example if you cross-browse to another device type), it will be shown as alien and won't play back. Depending on the data, you may be able to fix this by selecting the clip and selecting “Adjust Alien Clips to Lane”. This scales the automation data in the clip to fit the range of the current lane.

- ! **If it's not possible to scale the data, an alert will appear to tell you this.**

See [“About alien clips”](#) for more information.

## Quantize

This lets you quantize note clips and Single Take audio clips, as well as selected notes in note clips or selected Slices in Single Take audio clips. See [“Quantizing audio”](#) and [“Quantize”](#).

## Edit Sample

This command is available when a sample is selected in the Song Samples location. Selecting Edit Sample opens the sample in the Edit Sample window. See [“Editing samples”](#) for more information.

## Duplicate Sample(s)

This command is available when one or several samples are selected in the Song Samples location. Select this to create a duplicate of the selected sample. The duplicated sample is placed in the All Self-contained Samples and Un-assigned Samples folders. Several selected samples can be duplicated in one go. See [“Duplicating samples”](#) for more details.

## Export Sample(s)

This command is available when one or several samples are selected in the Song Samples location. Select this to export the selected sample to disk. A dialog appears where you can select file format. Several selected samples can be exported in one go. See [“Exporting samples”](#) for more details.

## Delete Sample(s)

This command is available when one or several samples are selected in the Song Samples location. Select this to permanently delete the selected sample(s) from the song. Note that samples from the Factory Soundbank and from ReFills will not be deleted from their original locations - only from the song document. Several selected samples can be deleted in one go. See ["Deleting samples from a song"](#) for more details.

## Edit Keyboard Control Mapping...

This menu command is available when Keyboard Control Edit Mode is selected. It will open a dialog where you can assign a Keyboard Control for a selected parameter. See ["Editing Keyboard Control"](#) for more information.

## Clear Keyboard Control Mapping

This menu command is available when Keyboard Control Edit Mode is selected. It will remove the Keyboard Control mapping for a selected assigned parameter. See ["Editing Keyboard Control"](#) for more information.

## Clear All Keyboard Control Mappings for Device

This menu command is available when Keyboard Control Edit Mode is selected. It removes all keyboard mapping you have set up for the selected device. See ["Editing Keyboard Control"](#) for more information.

## Edit Remote Override Mapping...

This menu command is available when Remote Override Edit Mode has been activated on the Options menu. It opens a dialog where you can assign a Remote Override for the selected parameter. See ["Remote Override mapping"](#).

## Clear Remote Override Mapping

This menu command is available when Remote Override Edit Mode has been activated on the Options menu. It will remove the Remote Override mapping for a selected assigned parameter. See ["Remote Override mapping"](#).

## Clear All Remote Override Mappings for Device

This menu command is available when Remote Override Edit Mode has been activated on the Options menu. It removes all Remote Override mapping you have set up for the selected device. See ["Remote Override mapping"](#).

## Copy/Paste Remote Override Mappings

These menu commands are available when Remote Override Edit Mode has been activated on the Options menu. You can use them to copy override mappings from one device and paste them into a device of the same type.

If the device you paste into is in the same song as the device you copied from, the operation will replace the existing overrides. See ["Remote Override mapping"](#).

## Go to Product Page...

With a Rack Extension device selected in the rack, selecting this item will start up your default web browser, which will take you to the product page for the R.E. at the Propellerhead web site.



# Preferences – General

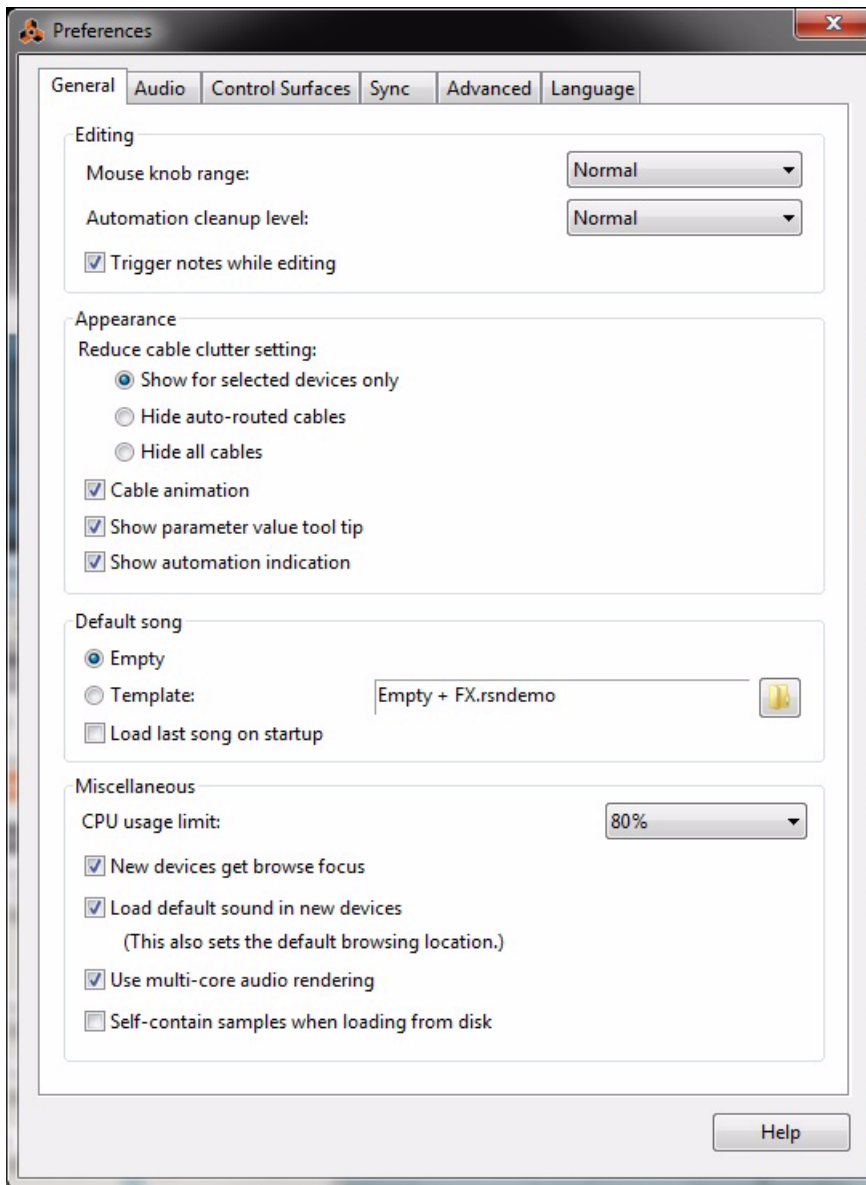

## Mouse Knob Range

This lets you adjust the response sensitivity of the various knobs in Reason when manipulating them with the mouse. A higher sensitivity gives a higher degree of precision. You can choose between Normal, Precise and Very Precise.

## Automation Cleanup Level

The Automation Cleanup setting reduces the number of automation points when you record or draw automation. Adjust this setting if you find that recording or drawing results in too many or too few automation points.

- **This can also be done manually from the Tool window (Sequencer Tools tab) - see “The “Automation Cleanup” function in the Tool Window”.**

## Trigger Notes while Editing

When this is selected, transposing notes, by manually moving them with the Selection Tool, will make the notes trigger - and sound. This is useful since you will hear when the notes reach the correct pitches.

## Reduce Cable Clutter Setting

The selected alternative determines how cables on the back of the rack should be displayed when “Reduce Cable Clutter” is selected on the Options menu:

- **Select “Show For Selected Devices Only” to only display the cables for selected devices.**  
All other (non-selected) devices will have “transparent” cables to make it easier to distinguish the cables of selected devices.
- **Select “Hide Auto-Routed Cables” to only display manually routed cables.**  
All devices with auto-routed cables will have “transparent” cables to make it easier to distinguish the manually routed cables.
- **Select “Hide All Cables” to hide all auto-routed and manually routed cables.**  
All cable connections on devices will be indicated with colored dots in the jacks, and no cables will be displayed.

See “[Cable appearance](#)” for more details.

## Cable Animation

Cables in Reason are animated in a lifelike fashion when flipping the Rack and making connections. Should you so wish, you can choose to disable the cable movement animation by deactivating this checkbox.

## Show Parameter Value Tool Tip

Normally, if you hold the mouse pointer over a parameter on a device panel for a moment, a Tool Tip appears displaying the name and the current value of the parameter. If you uncheck this option, Tool Tips will not be displayed.

## Show Automation Indication

If a parameter is automated in the sequencer, this is by default indicated by a green frame around the parameter on the device panel. If you uncheck this option, automation will not be indicated.

## Default Song

It's possible to specify a certain song document which will automatically open as a “template” each time you select “New” from the File menu. The Default Song could be an empty document, a song you have created earlier, or a factory made Template song. See “[Setting up a Default Song](#)” for information on how to select Default Song.

## Load Last Song On Startup

Checking this automatically opens the last saved song each time you launch Reason.

- **Tick the checkbox to open the last saved song the next time you launch Reason.**

## CPU Usage Limit

Reason is a very powerful program which was designed to be as light on processing power as possible - without compromising on sound quality. Nevertheless, the more devices and audio processing functions you use in your song, the more of your computer's resources it will use.

The CPU Usage Limit setting allows you to set a limit on how much of the CPU (computer processor) that should be used for creating audio. The remaining capacity is reserved for the user interface and the graphics.

Set this so that you feel comfortable using the program, even when a very demanding song document is played back.

### **New devices get browse focus**

When this is active, Browse focus is automatically set to new devices as soon as they have been created. This means that you can immediately start to browse for, and load, compatible patches for the devices you just created. Browse focus is indicated by orange sidebars and an orange patch section on the devices. The top section of the Browser also gets an orange label with the device's current patch name printed on it.

### **Load default sound in new devices**

When this is activated and you create a new device (of a device type that supports patches), a default patch will be loaded. This way you can be sure that a new device generates sound right away. The default sound will also determine the default location in the Factory Sound Bank when you browse for patches for the new device.

If you turn this off, new devices will be initialized - parameters are reset to their default values and no samples are loaded in sample-based devices.

**! Note that “Sound” also implies patches for effect devices such as the RV7000, the Line 6 Amps and Scream 4.**

### **Use multi-core audio rendering**

Reason fully supports MultiCore Audio Rendering. This means that if your computer has multiple CPU cores (dual-core or quad-core, for example), or multiple CPUs, Reason takes advantage of this to significantly enhance the performance. If your computer has a multi-core CPU, or multiple CPUs, MultiCore Audio Rendering is active by default. See [“Audio Basics”](#) for more information on how Reason handles audio.

### **Self-contain samples when loading from disk**

When this is activated, any samples you load into a sampler device from disk will automatically become self-contained and saved together with the rest of the song data when you save your Song.

# Preferences – Audio

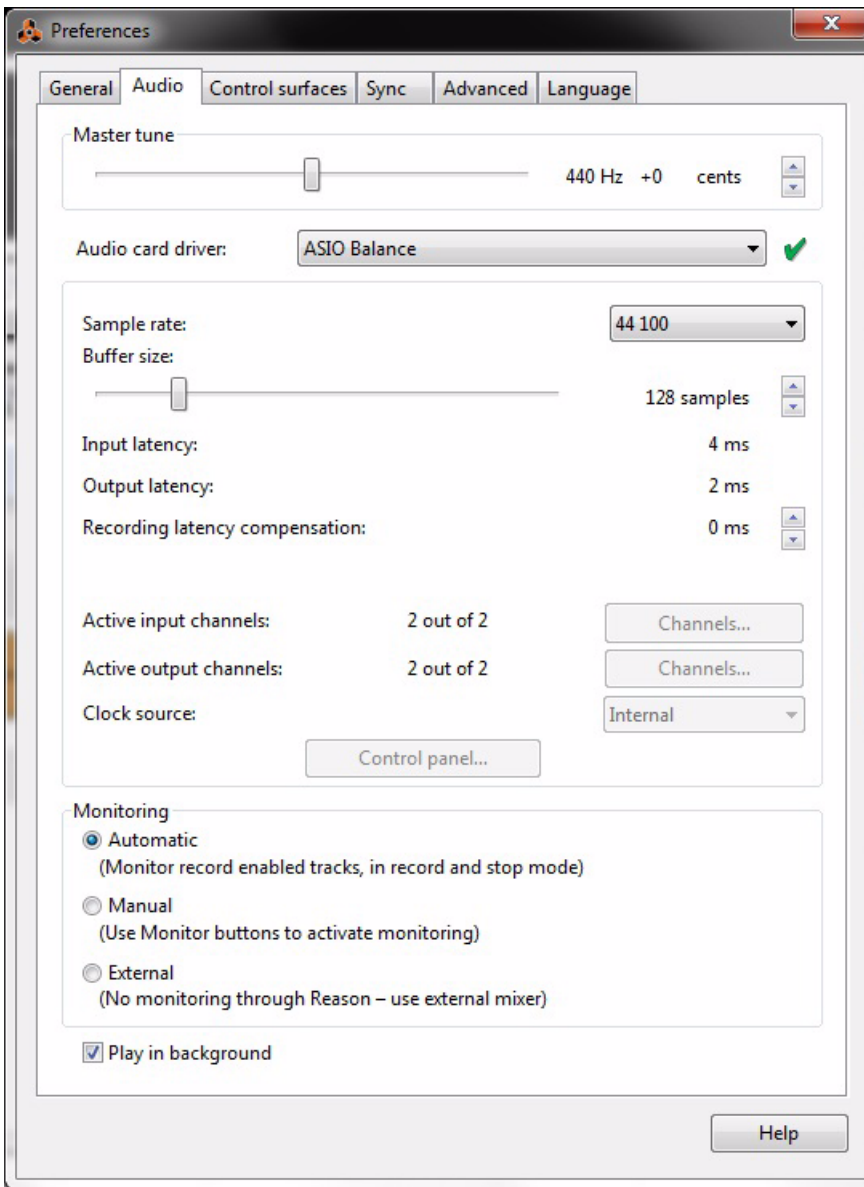

## Master tune

This lets you adjust the global tuning in Reason. Standard tuning is “middle A” at 440 Hz. You can adjust this by +/- 100 cents. The Master Tune setting affects the tuning of all sound sources in Reason, including the Tuner function on the Audio Tracks. It also affects the tuning of the Redrum and Dr. Octo Rex loop player.

**! Note that the Master Tune setting does not affect the pitch of the audio on audio tracks!**

## Audio card driver – Windows

This menu lists all the available Audio Card Drivers on your system, and lets you select which one Reason should use. Which option to select depends on the audio hardware:

- **If you are using audio hardware for which there is a specific ASIO driver, you should select this.**  
With an ASIO driver written specifically for the audio hardware you will get lower latency (see below), support for higher sampling frequencies (up to 192 kHz in 24 bit/32 bit float resolution), and possibly better support for additional hardware features such as multiple outputs.
- **If there is no specific ASIO driver, you could select a generic ASIO driver for the audio hardware.**
- ! **Reason requires that the audio card uses an ASIO driver on Windows systems, if you want to use both audio in and audio out. Direct X and MME drivers only support audio out.**

## Audio device – Mac OS X

This menu lists all the available Audio Devices on your system, and lets you select which one Reason should use. Which option to select depends on the audio hardware:

- **If you are using audio hardware for which there is a specific Core Audio driver, you should select this.**  
With a Core Audio driver written specifically for the audio hardware you will get lower latency (see below), support for higher sampling frequencies (up to 192 kHz in 24 bit/32 bit float resolution), and possibly better support for additional hardware features such as multiple outputs.

## Sample rate

Reason handles all internal audio processing in 32-bit floating point resolution, with 64-bit summing in the mix bus in the Main Mixer Master Section. However, the resolution of the input and output audio is determined by the hardware audio interface. That is, if you have a 24-bit audio card, Reason will record and output audio in 24-bit resolution, and if you have a 20-bit audio card, audio will be recorded and played back in 20-bit resolution.

The Sample Rate can be specified on the Audio tab in the Preferences dialog. See [“Sample Rate settings for recording and playback”](#) for more details.

## Buffer size

The Buffer Size determines the Input and Output Latency of the audio. Generally, the smaller the Buffer Size, the lower the latency. However, too low a Buffer Size setting could result in clicks, pops, dropouts, etc. in the audio. Therefore, the Buffer Size should be set to an “optimal” value rather than to the lowest value. See [“Buffer Size settings”](#) for more information.

## Input and Output latency

The Input latency is the delay between when the audio is “sent” from a connected microphone or instrument and when it’s received and detected by Reason. Output latency is the delay between when audio is “sent” from Reason and when you actually hear it. The latencies in an audio system depends on the audio hardware, its drivers and their settings.

When you select a driver, its latency values are automatically reported by the audio card and displayed in the Preferences-Audio dialog. Depending on the audio hardware and the driver, you may be able to adjust these values:

- **If you are using an ASIO driver specifically written for the audio hardware under Windows, you can in most cases make settings for the hardware by clicking the Control Panel button.**  
This opens the hardware’s ASIO Device Control Panel, which may or may not contain parameters for adjusting the latency. Usually this is done by changing the number and/or size of the audio buffers - the smaller the audio buffers, the lower the latency. Please consult the documentation of your audio hardware and its ASIO drivers for details!

OK, so why not just set the latency to the lowest possible value? The problem is that selecting too low a latency is likely to result in playback problems (clicks, pops, dropouts, etc.). There are several technical reasons for this, the main one being that with smaller buffers (lower latency), the average strain on the CPU will be higher. This also means that the more CPU-intensive your Reason song (i.e. the more tracks and devices you use), the higher the minimum latency required for avoiding playback difficulties.

See [“About latency”](#) for more information.

## Recording latency compensation

If you are monitoring via an external mixer, and have selected “External” in the “Monitoring” section on the “Audio” page in Preferences (see [“Monitoring”](#)), there might be situations where you experience that the recorded audio is generally played back too early - or too late - in the song. This could be because the latency values reported to Reason by the audio card were not completely accurate.

If you should experience that your audio recordings are played back too early or too late compared to the instrument tracks in your song, you can adjust this by editing the Recording Latency Compensation parameter.

See [“Recording Latency Compensation”](#) for information.

## Active input and output channels

This displays the number of audio input and output channels the currently selected audio hardware supports. If your audio card has multiple inputs and/or outputs, and an audio driver that supports this is selected, the “Channels...” button will be enabled. Clicking this will bring up a window with check boxes for all available inputs and outputs. By ticking these boxes, you are able to select which input and/or output channels should be active.

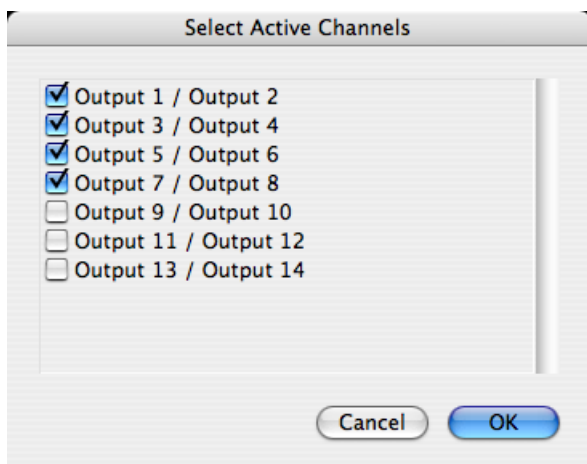

Active inputs and outputs will be also indicated with yellow and green LEDs in the Reason Hardware Interface - see [“How Reason communicates with your audio hardware”](#).

## Clock source (ASIO Only)

If you are using an ASIO driver for your audio hardware, you have the possibility of selecting a Clock Source. This is used for determining the source to which audio playback should synchronize its sample rate. If you have an audio card and a driver that supports it, you can choose to synchronize to external sources.

## Control panel

If you have selected an ASIO or Core Audio driver, this button brings up a control panel window specifically for that audio hardware. This may contain buffer settings, routing options, synchronization alternatives etc.

## Monitoring

In the Monitoring section you can choose how you want monitoring of the input signals to work on audio tracks.

- **Select “Automatic” to automatically monitor the input signals on all record enabled audio tracks when recording and when the sequencer is stopped.**

Record enabling of audio tracks is done by clicking the Record Enable button on the track in the track list - see [“Record enabling”](#).

- ! **Note that if you have selected “Standard” in the “Master Keyboard Input” section on the “Keyboards and Control Surfaces” page in Preferences (see [“The Master Keyboard Input setting”](#)), selecting an audio track also automatically record enables it - and consequently enables monitoring in “Automatic” mode.**

- **Select “Manual” to manually activate monitoring by clicking the Monitor button on the track in the track list.**
- **Select “External” if you are monitoring directly through your audio interface outputs (and not via the Reason application) - or via an external mixer.**

In “External” mode it's not possible to monitor in Reason.

## Play in background

When this is activated, Reason will not “release its grip” on the audio hardware when another application is active.

- **The advantage is that Reason will keep playing while you work in the other application.**
- **The disadvantage is that other audio applications may not be able to play any audio, depending on the type of driver used.**

## Preferences – Control Surfaces

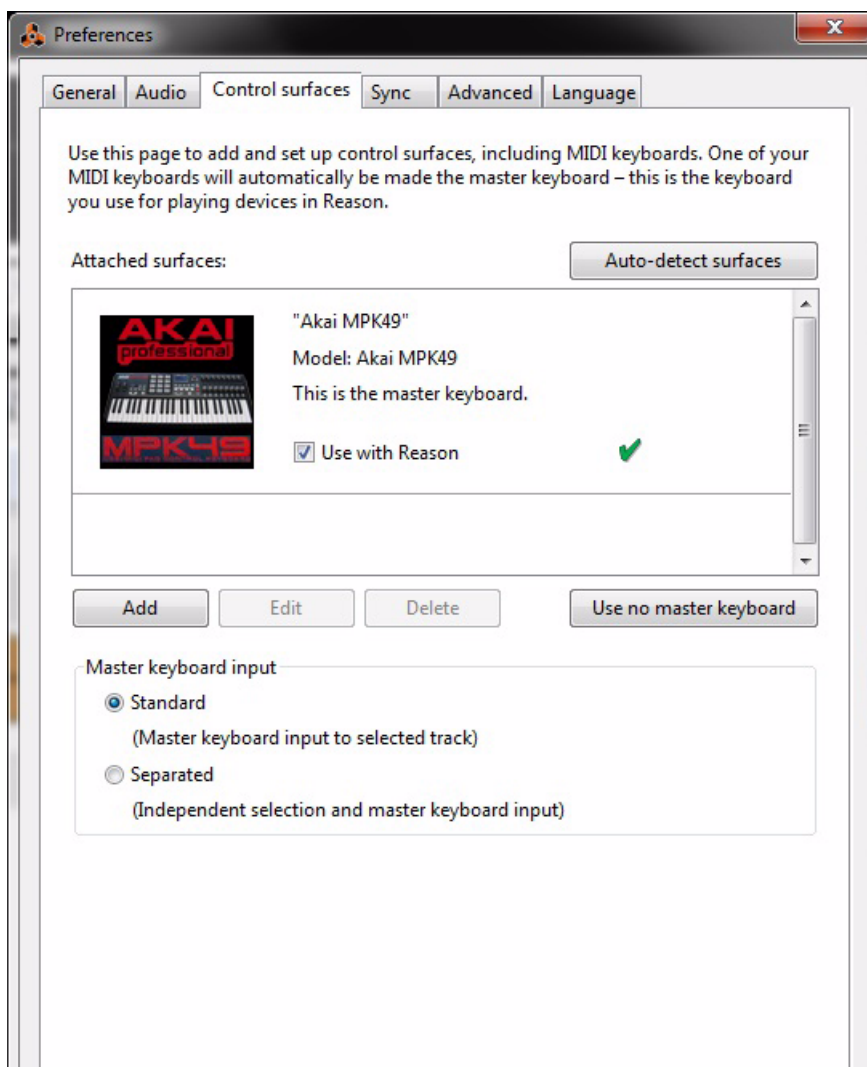

This is where you set up your MIDI hardware; keyboards and control surfaces.

- **The “Attached surfaces” list in the middle shows the currently added surfaces/MIDI keyboards.**  
Selecting a surface in the list allows you to edit its settings or delete it from the list, by clicking the corresponding “Edit” or “Delete” button.
- **Clicking the “Auto-detect surfaces” button will scan for connected control surfaces.**  
This requires a USB connection or a two-way MIDI connection. Note that not all control surfaces support auto-detection - but you can always add control surfaces manually.
- **If you have surfaces added in the “Attached surfaces” list that you do not wish to use with Reason, you can uncheck the “Use with Reason” checkbox.**
- **The “Use no master keyboard” button allows you to disable MIDI note input in the sequencer.**  
The surface designated as Master Keyboard cannot be locked to a specific device - it always follows the sequencer Master Keyboard Input. By selecting the Master Keyboard surface in the Attached Surfaces list and clicking this button allows you use Surface locking, although you will not be able to play the device. See [“Locking a surface”](#) in the Remote chapter for details.



## Adding or editing a control surface

To add a control surface, click the “Add” button to open the Control surfaces dialog. If you want to edit the settings for an existing control surface, click the “Edit” button. Then proceed as follows:

**1. Select the manufacturer of your control surface from the Manufacturer pop-up menu.**

If you can't find it on the menu, see below.

**2. Select the model of your control surface from the Model pop-up menu.**

If you can't find it on the menu, see below.

**3. An image of the selected control surface model is shown, often along with some information text - read this carefully.**

For some control surfaces, you need to select a specific preset to use the surface with Reason - this is noted here.

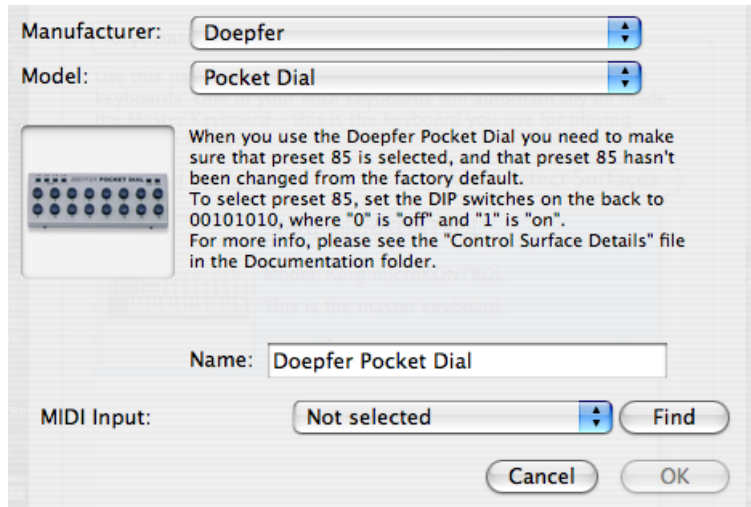

**4. Use the MIDI Input pop-up to select the input port to which you have connected the surface.**

If in doubt, you can click the “Find” button and then tweak a control or play a key on the control surface to have Reason find the correct input port for you.

**• Some control surfaces may have more than one MIDI Input pop-up menu.**

You need to select ports on all MIDI Input pop-up menus.

**• Some control surfaces will have a MIDI Output pop-up menu.**

In some cases this is labeled “Optional” - then you don't have to make a selection. In other cases, a MIDI Output is required. This is the case if the control surface uses MIDI feedback - motor fader, displays, etc.

**5. If you like, you can rename your control surface in the Name field.**

**6. Click OK to add the surface.**

→ **Depending on the surface model, alerts may appear, reminding you to select a specific preset etc.**

In some cases, Reason can restore a preset in the control surface to factory settings for you. If so, you will be informed about this.

Finally you return to the Control Surfaces Preferences page, where your added surface is now listed.

## If your control surface model isn't listed

If you can't find your control surface listed on the Manufacturer or Model pop-up menus when you try to add it, this means that there's no native support for that model. However, the program supports generic keyboards and controllers. Here's what to do:

→ **Select “Other” on the Manufacturer pop-up menu and then select one of the three options on the Model pop-up menu.**

or, if the Manufacturer is listed but not your specific model:

→ **Select one of the three “Other” options on the Model pop-up menu:**

In both cases, the options are:

- **MIDI Control keyboard**

Select this if you have a MIDI keyboard with programmable knobs, buttons or faders. You need to set up your control surface so that the controllers send the correct MIDI CC messages, depending on which Reason device you want to control - check out the MIDI Implementation Chart in the Reason documentation. If your control surface has templates or presets for different Reason 2.5 devices, these can be used.

- **MIDI Control Surface**

Select this if you have a MIDI controller with programmable knobs, buttons or faders (but without keyboard). Again, you need to set your controllers to send the right MIDI CCs.

- **MIDI Keyboard (No Controls)**

Select this if you have a MIDI keyboard without programmable knobs, buttons or faders. This is used for playing only (including performance controllers such as pitch bend, mod wheel, etc.) - you cannot adjust Reason device parameters with this type of control surface.

→ **Under the “Other” Manufacturer, there are also two options called “MIDI Multichannel Control Keyboard” and “MIDI Multichannel Control Surface”. Use these if the controls on your keyboard/control surface send the same MIDI message but on different MIDI channels. Read more in “[Adding a control surface or keyboard](#)” in the Remote chapter.**

After selecting a model, proceed with selecting MIDI input as described above.

## About the Master Keyboard

One of the control surfaces can be the Master Keyboard. This is like any other control surface, but it must have a keyboard and it cannot be locked to a specific Reason device (in other words, it always follows the MIDI input to the sequencer). This is the surface you use to play the instrument devices in Reason.

→ **The first surface with a keyboard that is added (or found by auto-detect) is automatically selected to be the Master Keyboard.**

This is shown in the Attached Surfaces list on the Preferences page.

→ **If you want to use another surface as Master Keyboard, select it in the list and click the “Make Master Keyboard” button.**

There can only be one Master Keyboard.

→ **If you don’t want to use any Master Keyboard at all, select the current Master Keyboard surface and click the same button (which is now labeled “Use No Master Keyboard”).**

## The Master Keyboard Input setting

This determines how you set Master Keyboard Input in the sequencer: to which track and device the Master Keyboard should be directed (which track to play from your keyboard):

- **In “Standard” mode, the selected track automatically gets Master Keyboard Input.**

This way you can just click anywhere on a track in the track list to select it for playing (or use the arrow keys to step up and down in the track list).

- **In “Separated” mode, you need to click directly on the device icon to the left in the track list to set Master Keyboard Input.**

This is useful if you’re working with multiple selections in the track list, or if you want to select different tracks for editing without changing which device you play from your keyboard.

- **Master Keyboard Input is indicated by a red border around the device icon in the track list.**

On instrument tracks, a small keyboard is also shown below the device icon. On other track types, a small control surface is shown below the device icon.

## Preferences - Sync

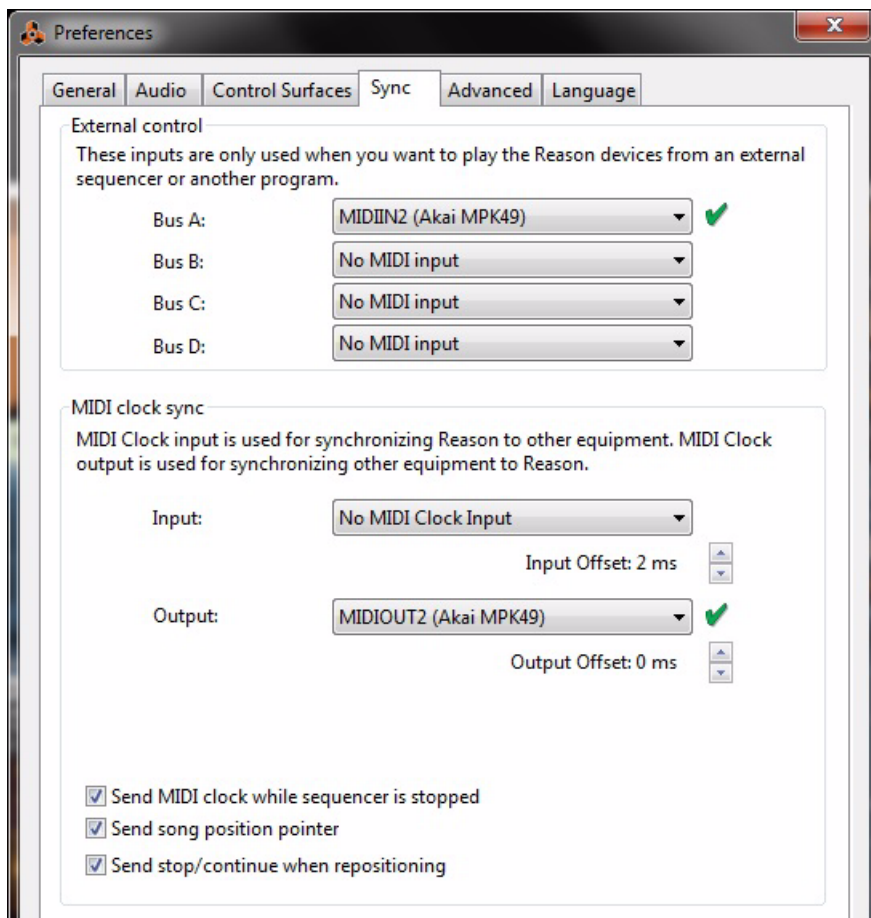

### External control

The External Control inputs provide up to 64 MIDI input channels divided into four buses, each with 16 channels.

- **These MIDI inputs are for individual control of Reason Devices from an external sequencer.**  
This could be an external hardware sequencer or sequencer software that is installed on the same computer as Reason. See the chapter [“Synchronization and Advanced MIDI”](#) for more details.

### MIDI clock sync

Using the MIDI Clock Input, you can slave (synchronize) Reason to external devices (tape recorders, drum machines, stand alone sequencers, workstations etc.) and other computer programs running on the same or another computer.

By using the MIDI Clock Output, Reason can act as MIDI Clock Sync Master for external equipment and applications.

As part of the MIDI Clock standard there are also options for sending out Start, Stop, Continue and Song Position Pointers, see [“Using Reason as MIDI Clock master”](#).

- **By first selecting the appropriate MIDI input and/or Output using the MIDI Clock Input/Output pop-ups and then selecting “MIDI Clock Sync” on the Options menu, Reason is ready to receive or send MIDI Clock sync.**  
See the [“Synchronization and Advanced MIDI”](#) chapter for more information.
- **There are also controls for adjusting the Input and Output Offsets.**  
See [“Adjusting for Latency”](#) for more information.

# Preferences – Advanced

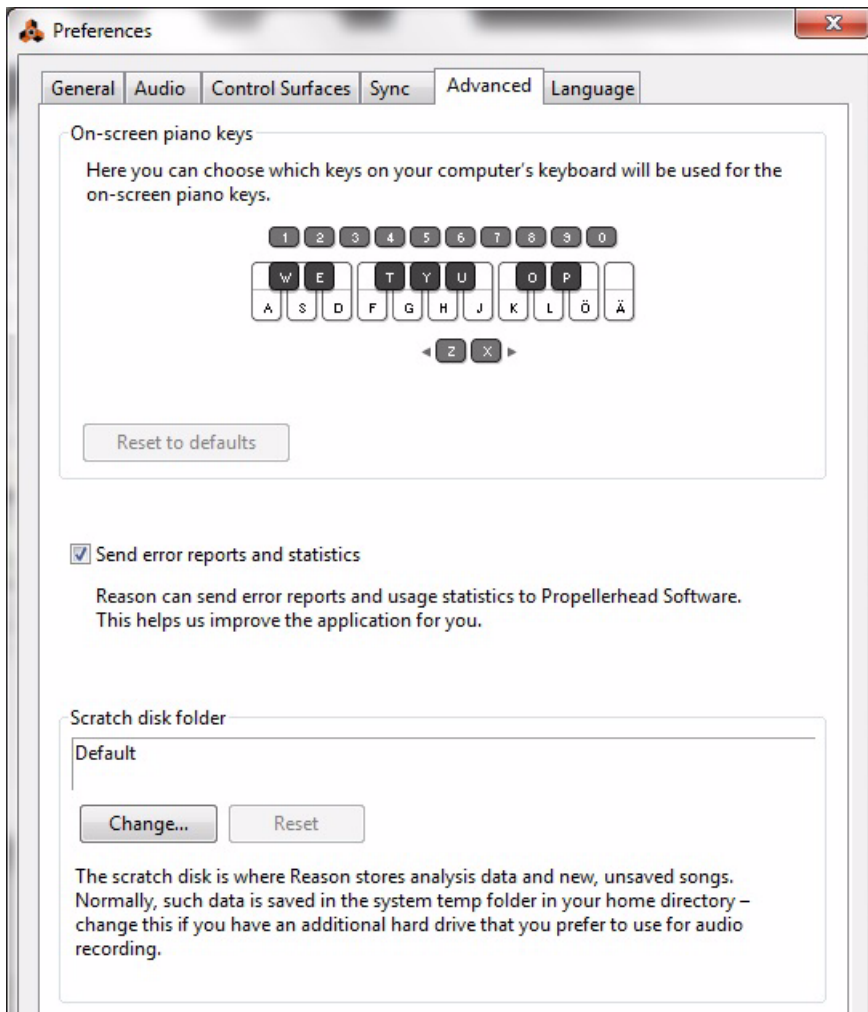

## On-screen piano keys

In this section you can specify what computer keyboard keys should be used for the On-Screen Piano Keys function.

- **To change key assignment, click on a key in the window and then press another available key on the computer keyboard to assign it.**

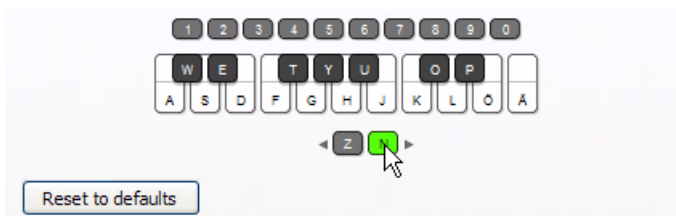

- Since many keyboard keys are already “locked” to other functions and commands in Reason, it’s not really applicable to reassign all the actual “play” keys. It’s more useful to reassign the Octave and Velocity (numeric) keys.
- **Click the Reset to Defaults button to revert to the preset keyboard keys assignment.**

See the “[On-screen Piano Keys](#)” chapter for information on how to use the On-screen Piano Keys.

## Send error reports and statistics

With this checkbox ticked you allow Reason to send error reports and usage statistics to Propellerhead to help us improve the program. These reports can also be extremely valuable, should we need to help you out with any support cases.

- ! **This function requires that your computer has access to the Internet.**
- ! **The data sent to Propellerhead does NOT contain any musical contents that you have recorded or created.**
- ! **This function does NOT affect the Reason performance negatively at all.**

## Scratch disk folder

Here you can select where you want to locate the Scratch Disk Folder. The Scratch Disk Folder is a temporary storage for recorded audio files before they have been manually saved in a song document file. By default, Reason places the Scratch Disk folder in the system temp folder in your home directory. You can manually change the Scratch Disk folder location if you like. See ["Changing Scratch Disk folder location"](#) for more information.

## Preferences - Language (Windows only)

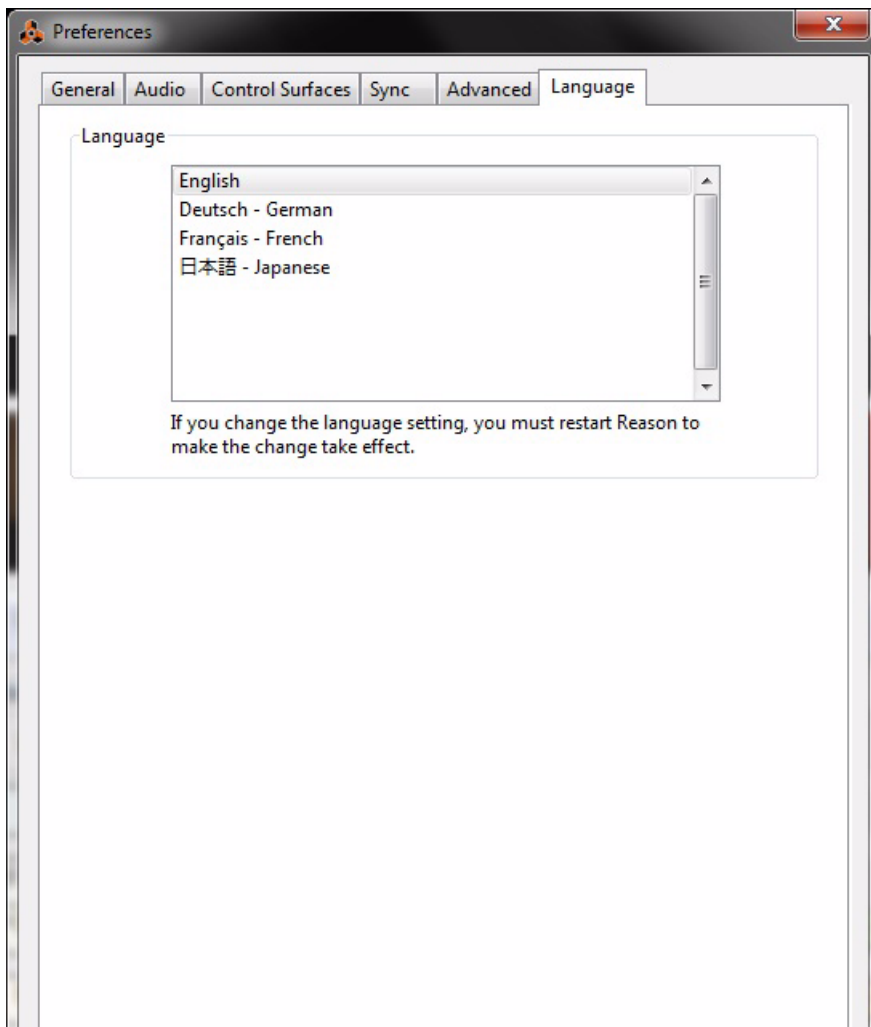

### Language (Windows only)

Reason is localized to several different languages. The language setting affects menus, dialogs, tool tips and some display texts, but generally not the texts on the device panels. If you run Reason under Windows, you can select preferred language on this page.

- ! **Note that you need to restart Reason for a language change to take effect.**
- ! **Under Mac OS X, Reason will use the language selected in the operating system.**

# Create menu

## Create Audio Track

Select this to create a new audio track in the sequencer, its associated Audio Track Device in the rack with its corresponding channel strip in the Main Mixer. The audio track, device and channel strip will be automatically named “Audio Track n”, where “n” is an incremental number.

You could then rename the track, device and channel strip afterwards if you like - see [“Naming tracks”](#).

## Create Instrument.../Create Effect...

Selecting this will open the corresponding device palette in the Browser, where you can add new devices to the rack. Depending on which menu item you selected, the browser will be set to show instrument or effect devices only.

## Create Send FX

Selecting this will open the Effect device palette in the Browser. If you create an effect device now, this will be automatically routed as a Send Effect to the first available FX Send and FX Return connector pair on the main mixer Master Section device.

## Instruments/Effects/Utilities

→ **To create a new device, select the desired item from one of the sub-menus.**

Depending on what type of device you create, the result can be different. See [“Creating devices”](#) for a complete description of what happens when you create different device types.

Rack Extension devices are sorted below the Reason devices, in alphabetical order per manufacturer. However, Propellerhead Rack Extension devices are always shown at the top of the Rack Extension section.

# Options menu

## Internal/MIDI Clock/ReWire/Send MIDI Clock

These four options are used to specify which type of tempo synchronization you want to use:

- **Internal**  
When this is activated, the program is not synchronized to any external source. It plays in the tempo set on the Transport Panel.
- **MIDI Clock**  
When this is activated, the program is synchronized to external MIDI Clock, as set up in the Preferences|Advanced dialog. The tempo setting on the Transport Panel is of no relevance; Reason plays in the tempo of the incoming MIDI Clock signals. See [“Synchronization and Advanced MIDI”](#) for more details.
- **ReWire**  
When this is activated, Reason is synchronized to another application via ReWire. This is not a setting that you can activate yourself, it is automatically enabled when the program is in ReWire slave mode. See [“ReWire”](#) for more details.
- **Send MIDI Clock**  
When this is activated, the program is MIDI Clock Sync Master and can control external applications/equipment. See [“Synchronization and Advanced MIDI”](#) for more details.

## Enable Keyboard Control

When this is activated, the computer's keyboard keys can be used to control devices, as set up with the Keyboard Control Edit feature. See [“Editing Keyboard Control”](#) for more information.

## Keyboard Control Edit Mode

- **To get an overview of which parameters are keyboard controllable select “Keyboard Control Edit Mode” from the Options menu.**  
Each device you select will show a yellow arrow symbol next to every parameter that can be assigned.
- **If you click on an assignable parameter to select it, you can then select “Edit Keyboard Control Mapping” from the Edit menu.**  
This opens a dialog allowing you to select a key command for that parameter.  
You may use any key or a combination of [Shift] + any key.
- **Simply press the key (or key combination) you wish to use to remote control the parameter.**  
The “Key Received” field momentarily indicates that it is “learning” the keystroke(s), and then the dialog displays the name of the key you have pressed. If [Shift] was used, the box beside the word Shift in the dialog is ticked.

You can also double-click on the arrow for an assignable parameter to set up keyboard control:

- **A rotating yellow rectangle appears, indicating Learn mode. Press the key (or key combination) you wish to use to remote control the parameter.**  
The rotating stops and the rectangle will now display the key or key combination you used.
- ! **Note that the transport panel uses the numeric keypad for various commands. If you assign a parameter to a single numeric key, the corresponding transport functionality will be overridden!**
- **Another way to assign keyboard control commands is to have “Keyboard Control Edit Mode” deselected on the Options menu, and to right-click (Win) or [Ctrl]-click (Mac) the parameter you wish to keyboard control.**  
This opens a pop-up menu, where one of the options will be “Edit Keyboard Control Mapping”. Selecting this opens the Keyboard Control dialog. Thus, you do not have to enable/disable Edit mode from the Options menu if you know that a parameter is assignable.



**! If you try to assign a key control that is already in use, you will get an alert asking if you wish to change the current assignment.**

See [“Editing Keyboard Control”](#) for more information.

## Remote Override Edit Mode

All supported control surface devices have “standard remote mappings” for each Reason device. If you wish to override this standard mapping, you can do so in the following way:

**1. To get an overview of which parameters can be assigned remote overrides, select “Remote Override Edit Mode” from the Options menu.**

Each device you select will show a blue arrow symbol beside every parameter that can be assigned a remote override. Standard mappings are marked with yellow knob symbols (only shown when the device has MIDI input). Assigned overrides are marked with a lightning bolt symbol.

**2. If you click on an assignable parameter to select it (selected parameters are orange in color), you can then select “Edit Remote Override Mapping...” from the Edit menu.**

This opens a dialog where you can assign override mappings.

**3. Make sure that the “Learn from Control Surface Input” box is ticked.**

**4. Simply turn the knob (or slider etc.) that you wish to use to assign Remote Override for the parameter.**

The “MIDI Received” field momentarily flickers as you turn the knob, and then the dialog shows the control surface device and the control you used.

You can also make override mappings manually:

→ **Select a device from the Control Surface pop-up in the dialog, and then select a control from the Control pop-up.**

On the Control pop-up, all the controls on the selected control surface are listed.

**5. Click “OK” to exit the dialog.**

The selected parameter is now tagged with a lightning bolt symbol, indicating Remote Override mapping.

**6. To exit Remote Override Edit mode, deselect it from the Options menu.**

You do not always have to use this method - see below.

If Remote Override Edit Mode is enabled on the Options menu, mapped parameters are “tagged”, and the arrow indicators show the assignable parameters. In this mode, however, you cannot operate Reason normally. Remote Override Edit mode is primarily for overview of available parameters and the current assignments.

→ **Another way to assign keyboard remote commands is to have “Remote Override Edit Mode” deselected on the Options menu, and to simply right-click (Win) or [Ctrl]-click (Mac) the parameter you wish to control.**

This opens a pop-up menu, where one of the options will be “Edit MIDI Remote Override Mapping”. Selecting this opens the “Edit Remote Override Mapping” dialog. Thus, you do not have to select Edit mode from the Options menu if you already know that a parameter is assignable.

See [“Remote Override mapping”](#) for more information.

## Additional Remote Overrides...

Selecting this opens a dialog with remote functions that cannot be assigned using Remote Override Edit mode, such as switching target tracks, Undo/Redo etc.

See [“Additional Remote Overrides...”](#) for details.

## Surface Locking...

This opens a dialog where you can lock a control surface to a specific device.

This means that the locked device is always “tweakable”, regardless of which track has MIDI input in the sequencer. This enables you to play and record notes for one device and at the same time control parameters for another device from a control surface.

For example, you could lock a control surface to control the main mixer, so you can always control overall levels while playing/tweaking other devices.

### → **The Master Keyboard device cannot be locked!**

If you select the Master Keyboard in the Preferences, you can click the “Use No Master Keyboard” button. You can then lock this control surface to a device and use its controllers to tweak parameters, but you will not be able to play the device.

### → **Each control surface can be locked to one device at a time (but you can lock several control surfaces to the same device).**

This locked device will always be controlled by the selected control surface, until you unlock the device or lock the surface to another device. You can lock as many devices you wish, as long as you have enough control surfaces.

### → **Locked devices can use remote overrides, just like unlocked devices.**

In other words, even if a device is locked to a control surface, some parameters could be overridden so they are controlled by another control surface, or some controls on the locked surface could be override-mapped to another device.

See the [“Locking a surface”](#) for more details.

## Toggle Rack Front/Rear

This switches the rack view between the front and rear panels. A quicker way to do this is to press [Tab].

## Reduce Cable Clutter

If there are many connections in Reason, the cables can sometimes obscure the view, making it difficult to read the text printed on the back panels of the devices. Cables can be displayed in “normal” mode and in “Reduced Cable Clutter” mode.

### → **Select “Reduce Cable Clutter” on the Options menu to “hide” the cables according to the setting you have made in the “Appearance” section on the “General” page in Preferences.**

See [“Cable appearance”](#) for information on how to use this function.

## Auto-group Devices and Tracks

A Device Group is a series of interconnected devices that “belong together”. A Device Group could, for example, be an instrument device connected via an effect device to a Mix Channel device. With the “Auto-group Devices and Tracks” option selected, moving/cutting/copying/duplicating and pasting a device in a device group will perform the operation on all devices in the device group.

See [“About Device Groups”](#) for more details.

## Show Navigators

Selecting “Show Navigators” will show the Channel Strip Navigator in the Main Mixer and the Rack Navigator in the rack.

Deselecting the “Show Navigators” option will hide the Channel Strip Navigator in the Main Mixer and the Rack Navigator in the rack.

## Follow Song

When this is activated, the sequencer Arrangement and Edit Panes will automatically scroll along with the song position pointer on playback. When this item is deactivated, the Arrangement and Edit Panes will remain stationary.

## Show Block Clip Content in Song View

When this is activated, the content of the Block Automatic Clip is displayed in a “ghosted” fashion on the arrangement pane. When deactivated, only the Block Automation Clip is displayed on the Blocks Track.

## Keep Events in Clip while Editing

This function determines how note and automation events behave if they are drawn, moved or pasted outside the boundaries of the open clip in Edit mode in the sequencer.

- **With “Keep Events in Clip while Editing” selected, events drawn, moved or pasted outside the boundaries of the open clip will still belong to the original clip - but will be masked.**
- **With the “Keep Events in Clip while Editing” deselected, the open clip will expand to contain the drawn, moved or pasted events - or, if this is not possible, the events will be placed in an existing, or new, clip.**

See [“About drawing notes outside an open clip”](#), [“About moving notes outside or between clips”](#) and [“Pasting events outside an open clip”](#) for detailed examples.

## Auto-color Tracks and Channels

When this option is activated, a color will automatically be assigned to a new sequencer track or mixer channel when you create it. Any new clips created on a track will get the same color as the track.

## Record Automation into Note Clip

With this option activated, any device parameter automation will be automatically recorded into the note clips as “Performance Controllers” instead of on separate Parameter Automation Lanes.

## Number of Precount Bars

Here you select the number of pre-count bars to use when the “Pre” button on the Transport Panel is on. When you record in the sequencer with the “Pre” button active, the recording will begin after the set number of precount bars.

→ **Select “One”, “Two”, “Three” or “Four” bars from the sub-menu that appears.**

## MIDI: Send All Notes Off

This sends an All Notes Off MIDI command on the MIDI Out ports used by Reason. This function can be used if you are experiencing hanging notes when you are controlling external MIDI instruments from Reason. See [“External MIDI Instrument”](#) for more information about MIDI controlling external equipment.

## Enter/Exit Edit Mode

This allows you to toggle the sequencer between Song/Blocks View and Edit Mode.

## Enable Blocks

This enables the Blocks function in the Sequencer. See [“Working with Blocks in the Sequencer”](#).

## Switch to Block View/Song View

This allows you to toggle the sequencer Arrangement between Blocks View and Song View.

# Window menu (Windows version)

## Stay on top

When this is activated, the Reason window will always stay on top of other program's windows.

## View Main Mixer

Selecting this, or pressing [F5], will maximize the Main Mixer area and bring it into view.

## View Racks

Selecting this, or pressing [F6], will maximize the Rack area and bring it into view.

## View Sequencer

Selecting this, or pressing [F7], will maximize the Sequencer area and bring it into view.

## Detach/Attach Main Mixer

Selecting this, or pressing [Ctrl]+[F5], will detach the Main Mixer from the Song document window, and open it in a separate window. When the Main Mixer is detached, the menu item text changes from Detach to Attach. Selecting this will then reattach the Main Mixer to the Song document window again.

## Detach/Attach Rack Window

Selecting this, or pressing [Ctrl]+[F6], will detach the Rack from the Song document window, and open it in a separate window. When the Rack is detached, the menu item text changes from Detach to Attach. Selecting this will then reattach the Rack to the Song document window.

## View All

Selecting this, or pressing [Ctrl]+[F7], will reattach any separate windows to the Song document window and show all areas equally sized.

## Rack Extensions

Selecting this starts up the Authorizer application, which displays the currently installed Rack Extension devices on your computer. Here you can also delete Rack Extension devices from your computer.

## Show/Hide Browser

Selecting this, or pressing [F3], will show or hide the Browser area.

## Show/Hide Transport

Selecting this will show or hide the Transport Panel.

## Show/Hide ReGroove Mixer

Selecting this will show or hide the ReGroove Mixer.

## Show/Hide Tool Window

Selecting this, or pressing [F8], will show or hide the floating Tool window. This window contains the Sequencer Tools tab (for editing sequencer data) and the Groove Settings tab (for fine-tuning and saving ReGroove patches).

## Show/Hide On-screen Piano Keys

Selecting this, or pressing [F4], will show or hide the floating On-screen Piano Keys window. See [“On-screen Piano Keys”](#) for information on how to use the On-screen Piano Keys window.

## Show Spectrum EQ Window

Selecting this, or pressing [F2], will show or hide the Spectrum EQ Window. See [“The Spectrum EQ Window”](#) for more information.

## Show/Hide Recording Meter

Selecting this, or pressing [Ctrl]+[F3], will show or hide the floating Recording Meter Window. See [“The Recording Meter Window”](#) for more information.

## Open Song Windows list

This lists all open song document windows. Selecting one makes it the active window. If songs have detached areas in separate windows, these will be included as separate items in the Open Documents list. The currently active window is indicated with a tick to the left of the window name:

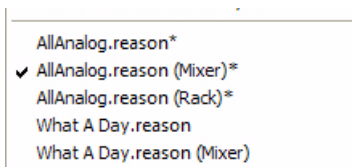

In the picture above, the “AllAnalog.reason (Mixer)” window is the currently active window, and consequently the “AllAnalog.reason” song is the currently active song. The Mixer and Rack areas of this song are currently detached in separate windows. The asterisks (\*) to the right of some of the windows show that the song currently contains unsaved edits.

# Window menu (Mac OS X version)

## Minimize

This minimizes the selected song document window.

## Zoom

This toggles the selected window between the default and the user defined size and position, according to the Apple guidelines. For detached Mixer and rack windows, the default state equals maximized across the screen.

## Bring All to Front

This will bring all open Reason windows in front of any other open application's window(s).

## View Main Mixer

Selecting this, or pressing [F5], will maximize the Main Mixer area and bring it into view.

## View Racks

Selecting this, or pressing [F6], will maximize the Rack area and bring it into view.

## View Sequencer

Selecting this, or pressing [F7], will maximize the Sequencer area and bring it into view.

## Detach/Attach Main Mixer

Selecting this, or pressing [Cmd]+[F5], will detach the Main Mixer from the Song document window, and open it in a separate window. When the Main Mixer is detached, the menu item text changes from Detach to Attach. Selecting this will then reattach the Main Mixer to the Song document window again.

## Detach/Attach Rack Window

Selecting this, or pressing [Cmd]+[F6], will detach the Rack from the Song document window, and open it in a separate window. When the Rack is detached, the menu item text changes from Detach to Attach. Selecting this will then reattach the Rack to the Song document window.

## View All

Selecting this, or pressing [Cmd]+[F7], will reattach any separate windows to the Song document window and show all areas equally sized.

## Rack Extensions

Selecting this starts up the Authorizer application, which displays the currently installed Rack Extension devices on your computer. Here you can also delete Rack Extension devices from your computer.

## Show/Hide Browser

Selecting this, or pressing [F3], will show or hide the Browser area.

## Show/Hide Transport

Selecting this will show or hide the Transport Panel.

## Show/Hide ReGroove Mixer

Selecting this will show or hide the ReGroove Mixer.

## Show/Hide Tool Window

Selecting this, or pressing [F8], will show or hide the floating Tool window. This window contains the Sequencer Tools tab (for editing sequencer data) and the Groove Settings tab (for fine-tuning and saving ReGroove patches).

## Show/Hide On-screen Piano Keys

Selecting this, or pressing [F4] will show or hide the floating On-screen Piano Keys window. See [“On-screen Piano Keys”](#) for information on how to use the On-screen Piano Keys window.

## Show Spectrum EQ Window

Selecting this, or pressing [F2], will show or hide the Spectrum EQ Window. See [“The Spectrum EQ Window”](#) for more information.

## Show/Hide Recording Meter

Selecting this, or pressing [Cmd]+[F3], will show or hide the floating Recording Meter Window. See [“The Recording Meter Window”](#) for more information.

## Open Song Windows list

This lists all open song document windows. Selecting one makes it the active window. If songs have detached areas in separate windows, these will be included as separate items in the Open Documents list. The currently active window is indicated with a tick to the left of the window name:

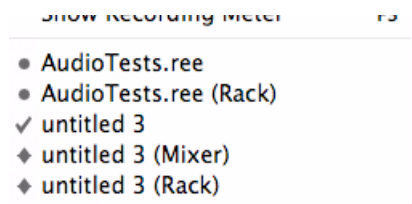

In the picture above, the “untitled 3” sequencer window is the currently active window, and consequently also the currently active song. The Mixer and Rack areas of this song are currently detached in separate windows and Minimized, as indicated by the symbols to the left. The round dots to the left of some of the windows show that the song currently contains unsaved edits.

# Help menu

## Reason Help...

This menu item opens up the on-line Help system in your default web browser. The Reason Help contains detailed information about all functions in Reason. You can choose to browse for information, either from the Table of Contents (TOC), Index or Search tabs in the Help system.

## Documentation in pdf format...

This takes you to the support section on Propellerhead, where you can download manuals in pdf format.

## Tutorials on the Propellerhead Webpage...

Selecting this item will open up your default web browser and direct you the Reason Video Tutorials page on the Propellerhead web site.

## Download more Demo Songs...

This takes you to our archives of song files that you can download and use.

## Download more Template Songs...

This takes you to our archives of song files that you can download and use.

## Go to the Propellerhead Website...

This takes you to the main entrance on the Propellerheads web site.

## Check for Updates...

This checks for recent Reason updates on the Propellerhead server.

## Your Profile... (Windows only)

This menu item launches your default web browser and brings you to your Profile page on Propellerhead. There you can log in, make settings and manage your music.

## Get more Instruments, Sounds & Effects

This item starts up your default web browser and takes you to the Propellerhead Shop, where you can get more Rack Extension devices for your Reason rack and also purchase additional ReFills.

## Go to Product Page...

With a Rack Extension device selected in the rack, selecting this item will start up your default web browser, which will take you to the product page for the R.E. at the Propellerhead web site.

## About Reason (Windows only)

This menu item opens up a dialog that informs you about the version of the program and the people behind it.



# **Chapter 52**

## **Key Commands**

# About the Key Commands chapter

This chapter contains compiled lists of all keyboard shortcuts and modifier keys available in Reason - and in all Reason devices. Keyboard shortcuts are keys or combinations of keys that can be pressed to execute various functions. Modifier keys are keys that can be used in combination with the mouse, to execute additional functions.

**! In most cases, which key(s) to use is different on Mac OS X and Windows. The keys to use are listed in the right column of the tables below, with the Mac key(s) to the left and the Windows key(s) to the right of the slash, i.e. [Mac key(s)]/[Windows key(s)].**

## General keyboard shortcuts

Function	Key(s)
Maximize/restore Main Mixer	[F5]
Maximize/restore Rack	[F6]
Maximize/restore Sequencer	[F7]
Maximize Main Mixer and Rack in one window	[F5]+[F6]
Maximize Main Mixer and Sequencer in one window	[F5]+[F7]
Maximize Rack and Sequencer in one window	[F6]+[F7]
Detach/Attach Main Mixer	[Command]/[Ctrl]+[F5]
Detach/Attach Rack	[Command]/[Ctrl]+[F6]
View All in one window	[Command]/[Ctrl]+[F7] or [F5]+[F6]+[F7]
Show/hide Spectrum EQ Window	[F2]
Show/hide Browser	[F3]
Show/Hide Recording Meter	[Command]/[Ctrl]+[F3]
Show/hide On-screen Piano Keys window	[F4]
Show/hide Tool window	[F8]
Toggle Rack front/rear	[Tab]
Create new Song	[Command]/[Ctrl]+[N]
Open Song	[Command]/[Ctrl]+[O]
Save Song	[Command]/[Ctrl]+[S]
Save Song As	[Shift]+[Command]/[Shift]+[Ctrl]+[S]
Close active detached Rack or Mixer window	[Command]/[Ctrl]+[W]
Close Song (if the window containing the Sequencer is active)	[Command]/[Ctrl]+[W]
Import Audio File	[Command]+[Option]/[Shift]+[Ctrl]+[I]
Quit (Mac OS X only)	[Command]+[Q]
Exit (Windows only)	[Alt]+[F4]
Undo	[Command]/[Ctrl]+[Z]
Redo	[Command]/[Ctrl]+[Y]
Delete Devices and Tracks	[Del] or [Backspace]
Delete Devices and Tracks (without warning).	[Command]/[Ctrl]+[Del] or [Command]/[Ctrl]+[Backspace]
Duplicate Devices and tracks, or selected clip(s), or selected comp row(s) in open audio clips, or selected note(s) in note clips, or selected automation point(s) in automation clips.	[Command]/[Ctrl]+[D]
Select All	[Command]/[Ctrl]+[A]
Route to > New Output Bus	[Command]/[Ctrl]+[G]
Create Audio Track	[Command]/[Ctrl]+[T]

Function	Key(s)
Create Instrument	[Command]/[Ctrl]+[I]
Create Instrument (Windows only)	[Insert]
Create Effect	[Command]/[Ctrl]+[F]
Browse Patches for selected device.	[Command]/[Ctrl]+[B]
Toggle the "Reduce Cable Clutter" option	[K]
Toggle the "Auto-group Devices and Tracks" option	[Command]+[Shift]/[Ctrl]+[Shift]+[G]
Toggle the "Follow Song" option	[F]
Toggle the "Keep Events in Clip While Editing" option	[Shift]+[Command]/[Shift]+[Ctrl]+[K]
Toggle the Show Block/Song View option (when Blocks are on)	[B]
Hide Reason (Mac OS X only)	[Command]+[H]
Minimize Reason (Mac OS X only)	[Command]+[M]
Open Preferences (Mac OS X only)	[Command]+[,]
Cut Track & Device (track selected in Track List), Cut Clip or Event (depending on current selection).	[Command]/[Ctrl]+[X]
Copy Track & Device (track selected in Track List), Copy Clip or Event (depending on current selection).	[Command]/[Ctrl]+[C]
Paste Track & Device, Paste Clip or Event.	[Command]/[Ctrl]+[V]
Open Help	[Command]+[?]/[F1]
Switch to one of the 10 corresponding global Remote variations (or "keyboard shortcut variations").	[Command]+[Option]/[Ctrl]+[Alt]+[1]...[0]

## General modifier keys

Function	Key/Action
Duplicate (copy) the selected item and its corresponding components.	[Option]/[Ctrl]+drag and drop device/track/mixer channel
Disable auto-routing of device.	[Shift]+Create device
Fold/unfold all devices.	[Option]/[Alt]+Fold/unfold device
Fold/unfold all tracks.	[Option]/[Alt]+Fold/unfold track
Select multiple devices/tracks/channels	[Command]/[Ctrl]+Select
Select range of multiple devices/tracks/channels	[Shift]+Select
Select multiple clips/events in the Sequencer	[Shift]/[Ctrl]+Select (Windows only: [Shift]+Select to select a range of clips/events in the Sequencer)
Increase precision when making settings.	[Shift]+Move fader/knob
Reset parameter to default value.	[Command]/[Ctrl]+Click fader/knob
Prevent creation of Sequencer-track for devices that normally will get a track. Create Sequencer-track for devices that normally will <i>not</i> get a track.	[Option]/[Alt]+Create device
Create a parameter automation lane for the parameter.	[Option]/[Alt]+Click device fader/knob/button

## Transport keyboard shortcuts

Function	Key(s)
Play	Numeric keypad [Enter]
Stop, Go to start position, Go to start of Song.	[Shift]+[Return] or numeric keypad [0]
Go to start of Song	[,]/[.] on numeric keypad
Toggle Stop/Play	[Spacebar]

Function	Key(s)
Record	[Command]/[Ctrl]+[Return] or numeric keypad [*]
Rewind	Numeric keypad [4]
Fast Forward	Numeric keypad [5]
Go to Loop Start	[Option]/[Alt] and left arrow key. Numeric keypad [1]
Go to Loop End	[Option]/[Alt] and right arrow key. Numeric keypad [2]
Move forward one Bar	Numeric keypad [8]
Go back one Bar	Numeric keypad [7]
Tempo Up	Numeric keypad [+]
Tempo Down	Numeric keypad [-]

## Sequencer keyboard shortcuts

Function	Key(s)
Toggle Arrange/Edit Mode.	[Shift]+[Tab] or [Command]/[Ctrl]+[E]
Toggle Song/Blocks view.	[B]
Select Arrow tool.	[O]
Select Pencil tool.	[W]
Select Eraser tool.	[E]
Select Razor tool.	[R]
Select Mute tool	[T]
Select Magnifying Glass tool.	[Y]
Select Hand tool.	[U]
Open selected clip for editing	[Return]
Close open clip	[Return] or [Esc]
Quantize	[Command]/[Ctrl]+[K]
Duplicate Track & Device (device or track selected).	[Command]/[Ctrl]+[D]
Join selected Clips on the same lane.	[Command]/[Ctrl]+[J]
Merge Note Lanes on Tracks.	[Command]/[Ctrl]+[R]
Mute/Unmute selected Clips.	[M]
Snap on/off.	[S]
Toggle Metronome click on/off	[C] or numeric keypad [9]
Toggle Metronome Pre-count on/off	[Command]/[Ctrl] and [P]
New Dub	[.] or numeric keypad [3]
New Alt	[.] or numeric keypad [6]
Loop on/off	[L] or numeric keypad [/]
Set Loop Locators to encompass all selected clips	[Command]/[Ctrl]+[L]
Set the Left and Right Loop Locators to encompass selected clips and start play-back in Loop Mode.	[P]
Move Loop range one bar to the left	[Option]/[Alt]+[Shift] and up arrow key
Move Loop range one bar to the right	[Option]/[Alt]+[Shift] and down arrow key
Move current Loop range one loop length to the left.	[Option]/[Alt] and arrow up key.
Move current Loop range one loop length to the right.	[Option]/[Alt] and arrow down key.

Function	Key(s)
Horizontal zoom in	[H] or [Command]/[Ctrl]+[+]
Horizontal zoom out	[G] or [Command]/[Ctrl]+[-]
Vertical zoom in	[Command]+[Option]/[Ctrl]+[Alt]+[+]
Vertical zoom out	[Command]+[Option]/[Ctrl]+[Alt]+[-]
Zoom To Selection/Show All (e.g. selected clips)	[Z]
Follow Song on/off (auto-scrolling Arrange/Edit pane)	[F]

## Sequencer keyboard shortcuts in Audio Edit Mode

Function	Key/Action
Select Speaker tool	[I]
Change Comp Row assignment in the segment with focus in Comp Mode	[Command]+[Option]+[Shift]/[Ctrl]+[Alt]+[Shift] and up/down arrow keys
Change segment focus in Comp Mode.	[Command]+[Option]+[Shift]/[Ctrl]+[Alt]+[Shift] and left/right arrow keys
Exit inline editing for Single Take audio clips	[Esc]

## Sequencer modifier keys

Function	Key/Action
Select alternate tool in Toolbar	[Command]/[Alt]
Toggle Pencil/Line tool (velocity edit lane only).	[Option]/[Ctrl]
Edit velocity of selected notes only	[Shift]+click/draw with Pencil tool on Velocity lane
Create automation lane for parameter. If device has no track, a track will also be created.	[Option]/[Alt]+Click knob/fader/button
Restrict movement direction to either horizontal or vertical.	[Shift]+Move events/clips
Zoom in/out horizontally on the Edit/Arrange pane.	[Shift]+Drag any of the Song Navigator handles sideways
Zoom in/out horizontally on the Edit/Arrange pane. (Drag sideways to scroll horizontally at the same time)	[Shift]+Drag up/down in Song Navigator frame
Copy data instead of moving it.	[Option]/[Ctrl]+Move data
Set Left Locator in ruler.	[Option]/[Ctrl]+Click
Set Right Locator in ruler.	[Command]/[Alt]+Click
Set End Marker in ruler.	[Shift]+Click
Switch to zoom out with the Magnifying Glass tool instead of zoom in (with either the Magnifying Glass- or the Hand tool selected).	[Option]/[Ctrl]+Click
Limit movement to one direction only. Horizontal or vertical.	[Shift]+Drag with Hand tool or Eraser tool
Disable vertical zooming. Horizontal zoom only.	[Shift]+Zoom with Magnifying Glass tool

## Sequencer modifier keys with mouse wheel

Function	Key/Action
Scroll horizontally.	[Shift]+Mouse wheel
Zoom in/out vertically.	[Command]/[Ctrl]+Mouse wheel
Zoom in/out horizontally.	[Shift]+[Command]/[Shift]+[Ctrl]+Mouse wheel

## Sequencer modifier keys in Audio Edit Mode

Function	Key/Action
Switch from Arrow tool to Cut (Razor) tool on the comp rows in an open audio clip	[Command]/[Alt]
Switch from Arrow tool to Speaker tool on the comp rows in an open audio clip	[Command]+[Shift]/[Alt]+[Shift]
Duplicate the Comp Row and create a new Cut or Segment in the duplicated Comp Row.	[Command]+[Option]/[Ctrl]+[Alt] and click or swipe on Comp Row

## Arrow keys

Function	Key/Action
Select next device up or down (rack selected), select next track up or down (track list selected), select clip on next/previous lane (Arrange view selected).	Arrow up/down keys
Select next/previous clip on lane (Arrange view selected), select next/previous value field (Position displays).	Arrow left/right keys
Nudge selection one Snap unit back/forward in the sequencer.	[Command]/[Ctrl]+Arrow left/right keys
Nudge selection one Beat back/forward in the sequencer.	[Shift]+[Command]/[Shift]+[Ctrl]+Arrow left/right keys
Nudge selection one Tick back/forward in the sequencer.	[Option]+[Command]/[Alt]+[Ctrl]+Arrow left/right keys
Transpose selected notes in Edit mode	[Command]/[Ctrl]+ up/down arrow keys

## Save dialog keyboard shortcuts

These key commands can be used in the save dialog that appears if you close a song document that contains unsaved changes:

Function	Key(s)
Cancel	[Command]+[.] [Esc]
Yes (save song)	[Return]/[Y]
No (do not save song)	[Command]+[D]/[N]

## On-screen Piano Keys keyboard shortcuts

These keyboard shortcuts are valid only when the On-screen Piano Keys window is open and set to “Computer Keys” mode.

Function	Key(s)
Sustain	[Shift]
Octave Down	[Z]
Octave Up	[X]
Velocity value = 1	[1]
Velocity value = 14	[2]
Velocity value = 28	[3]
Velocity value = 42	[4]
Velocity value = 56	[5]
Velocity value = 70	[6]
Velocity value = 84	[7]
Velocity value = 98	[8]
Velocity value = 112	[9]
Velocity value = 127	[0]

## NN-19 modifier keys

Function	Key/Action
Audition sample.	[Option]/[Alt]+Click in keyboard display
Edit selected sample	[Option]/[Alt]+Click the Sample button

## NN-XT keyboard shortcuts

Function	Key(s)
Remove zone(s) from key map.	[Delete] or [Backspace]
Select All Zones	[Command]/[Ctrl]+[A]
Copy selected Zone(s)	[Command]/[Ctrl]+[C]
Paste currently copied Zone(s)	[Command]/[Ctrl]+[V]

## NN-XT modifier keys

Function	Key/Action
Audition sample. In sample column, at root pitch and unprocessed. In keyboard column, at corresponding pitch and with processing applied.	[Option]/[Alt]+Click in sample column or keyboard column
Set root note of sample with edit focus.	[Command]/[Ctrl]+Click in keyboard column
Edit selected sample	[Option]/[Alt]+Click the Sample button

## Dr. Octo Rex keyboard shortcuts

Function	Key(s)
Cut Loop.	[Command]/[Ctrl]+[X]
Copy Loop.	[Command]/[Ctrl]+[C]
Paste Loop.	[Command]/[Ctrl]+[V]

## Dr. Octo Rex modifier keys

Function	Key/Action
Audition slice.	[Option]/[Alt]+Click slice in overview
Reset slice(s) to default parameter value in Slice Edit Mode	[Command]/[Ctrl]+ click/click and drag in overview.

## Redrum keyboard shortcuts

Function	Key(s)
Cut Pattern.	[Command]/[Ctrl]+[X]
Copy Pattern.	[Command]/[Ctrl]+[C]
Paste pattern.	[Command]/[Ctrl]+[V]
Shift Pattern Left.	[Command]/[Ctrl]+[J]
Shift Pattern Right.	[Command]/[Ctrl]+[K]
Randomize Pattern.	[Command]/[Ctrl]+[R]
Alter Pattern.	[Shift]+[Command]/[Shift]+[Ctrl]+[P]

## Redrum modifier keys

Function	Key/Action
Enter "Hard" note when programming Pattern.	[Shift]+Click Pattern Step button
Enter "Soft" note when programming Pattern.	[Option]/[Alt]+Click Pattern Step button
Edit selected sample	[Option]/[Alt]+Click a Sample button

## Kong modifier keys

Function	Key/Action
Audition slice in Nurse Rex.	[Option]/[Alt]+Click slice in overview
Toggle "Trig" for slice(s) in Nurse Rex	[Command]/[Ctrl]+ click in overview.
Edit selected sample	[Option]/[Alt]+Click the Sample button in the NN-Nano

## Matrix keyboard shortcuts

Function	Key(s)
Cut Pattern.	[Command]/[Ctrl]+[X]
Copy Pattern.	[Command]/[Ctrl]+[C]
Paste Pattern.	[Command]/[Ctrl]+[V]
Shift Pattern Left.	[Command]/[Ctrl]+[J]
Shift Pattern Right.	[Command]/[Ctrl]+[K]
Shift Pattern Up.	[Shift]+[Command]/[Shift]+[Ctrl]+[U]
Shift Pattern Down.	[Shift]+[Command]/[Shift]+[Ctrl]+[D]
Randomize Pattern.	[Command]/[Ctrl]+[R]
Alter Pattern.	[Shift]+[Command]/[Shift]+[Ctrl]+[P]

## Matrix modifier keys

Function	Key/Action
Allows you to draw lines and ramps.	[Shift]+Draw Key/Curve values
Temporarily toggle Tie mode on/off.	[Shift]+Draw Gate

## RPG-8 keyboard shortcuts

Function	Key(s)
Shift Pattern Left.	[Command]/[Ctrl]+[J]
Shift Pattern Right.	[Command]/[Ctrl]+[K]
Randomize Pattern.	[Command]/[Ctrl]+[R]
Alter Pattern.	[Shift]+[Command]/[Shift]+[Ctrl]+[P]

## External MIDI Instrument keyboard shortcuts

Function	Key/Action
MIDI: Send All Notes Off	[!]



# **Index**

## A

- Active Input Channels (in Preferences) 1038
- Active Output Channels (in Preferences) 1038
- Add Labels To Clips 177, 1030
- Additional Remote Overrides... 505
  - Assigning 506
- Adjust Alien Clips to Lane 175, 1031
- ADSR 588
- Advanced MIDI (Hardware Interface) 521
- Advanced MIDI Device (Hardware Interface) 534
- Alien Clips 175
- All Notes Off (MIDI) 827
- Alligator 872
  - Dry Ducking 880
  - Effects 878
  - Filters 876
  - Mix Controls 880
  - Patterns 874
- Allround (Stretch and Transpose Type) 223
- Alt
  - On Audio Tracks 140
  - On Instrument Tracks 151
- Alt Button (Transport Panel) 119
- Alt Group (Dr. Octo Rex) 749
- Alter
  - Pattern (Redrum) 774
  - Pattern (RPG-8) 1002
- Alter Notes (Tool Window function) 250
- Alter Pattern (Matrix) 987
- Alternate Tools 113
- Analyzer 378
- Anchor Point (ReGroove Mixer) 476
- Appearance (Cables) 351
- Arpeggio Notes to Track 1027
- ASIO Control Panel 525
- Assigned Samples 465
- Attach Main Mixer
  - Mac OS X Version 1054
  - Windows Version 1052
- Attach Rack Window
  - Mac OS X Version 1054
  - Windows Version 1052
- Audio
  - Formats 434
  - Importing to Sequencer Track 435
  - Quantizing 196
- Audio Clipping 70
- Audio Clips
  - Adding Crossfades 215
  - Adding Cuts 214
  - Adding Segments 215
  - Bounce Clip to REX Loop 197
  - Bounce Clip(s) to New Recording(s) 218
  - Bounce Clip(s) to New Sample 211
  - Changing Comp Row Assignments 217
  - Comping 219
  - Deleting Cuts 216
  - Editing Fades 165, 167
  - Editing Levels 165, 167
  - Importing Audio to... 437
  - Joining 180
  - Matching to Tempo 227
  - Moving Cuts 216
  - Normalising 212
  - Opening 189
  - Quantizing 196
  - Reversing 213
  - Scale to Tempo 223
  - Transpose Display (Inspector) 165
  - Transposing 225
  - Transposing in Tool Window 256
- Audio Hardware 66
- Audio In (to Application) 66
- Audio Input List (Audio Tracks) 103
- Audio Levels 70
- Audio Out (from Reason) 66
- Audio Quality 67
- Audio Settings 68
- Audio Track Channel Strip 363
- Audio Track Device 363
- Audio Tracks
  - Creating 93
  - Monitoring 134
  - Mono or Stereo 93, 132
  - Record Enabling 125
  - Recording 137
    - From Mix Channels 142
    - In Loop Mode 139
    - Mixdown 144
    - Over Existing Clips 141
  - Recovering 430
  - Selecting Audio Inputs 132
  - Setting Input Levels 133
  - Setting Up 132
- Auditioning
  - Samples and REX Files (in the Browser) 339
- Auto-color Tracks and Channels 1051
- Auto-group Devices and Tracks 301, 302, 306
- Automap Samples 675, 1020

- Automap Zones 716, 1024
- Automap Zones Chromatically 1024
- Automation
  - Deleting Events 267
  - Drawing Events 266
  - Editing 263
  - Editing in Edit Mode 265
  - Editing in the Song/Block View 263
  - Matching 279
  - Showing in Device Panels 1034
  - Tempo 273
  - Time Signature 275
    - Deleting Clips 276
    - Moving, Resizing and Duplicating Clips 276
- Automation As Perf Ctrl 154
- Automation Cleanup
  - About 269
  - In Preferences 269
  - Tool Window function 269
- Automation Cleanup Level 1033
- Automation Clips
  - Opening 234
- Automation Override Reset 157
- Auto-route Device 355
- Auto-routing 353
  - Audio Input Signals 353
  - CV/Gate Signals 355
  - Effect Devices 354
  - Instrument Devices 354
- B**
- Back Panel (Rack) 357
- Bank Select (External MIDI Instrument device) 828
- Bars
  - Inserting (in the Sequencer) 184
  - Removing (in the Sequencer) 184, 185
- BELL mode (EQ in the Main Mixer) 378
- Big Waveform Zoom Mode 46
- Bipolar Curves (Matrix) 984
- Blend (Pulveriser) 868
- Block Automation Clips
  - Combining with Song Clips 293
  - Converting to Song Clips 291
  - Creating 286
  - Muting Lanes in... 289
  - Resizing 288
- Blocks
  - Coloring 285
  - Defining Length of... 285
  - Overview 283
  - Renaming 285
  - Selecting for Editing 284
- Bounce
  - Audio Clips 442
  - Mixer Channels 440
- Bounce Button (Comp Editor) 223
- Bounce Clip to Disk 442
- Bounce Clip to REX Loop 197
- Bounce Clip(s) to New Recording(s) (Audio Clips) 218
- Bounce Clip(s) to New Sample (Audio Clips) 211
- Bring All to Front (Mac OS X) 1054
- Browse Focus
  - Clearing 324
  - Setting 322, 324
- Browse Loops 1019
- Browse Patches 1018
- Browse Samples 1019
- Browser 35, 300
  - About 328
  - Favorites Lists 336
  - Locations and Favorites 336
  - Open and Close 328
  - Search 342
- Buffer Size
  - Settings 69
  - Slider 525
- Bus FX Parameter 1 & 2 815
- Bypass/On/Off Switch (on Effect Devices) 954
- C**
- Cables
  - Appearance 351
  - Automatic Routing 353
  - Checking Connections 352
  - Color 353
  - Connecting by Dragging 358
  - Connecting using Pop-up Menus 358
  - Deactivating Animation 1034
  - Disconnecting 359
  - Hiding and Showing 351
  - Manual Routing 357
  - Scroll to Connected Device 352
- Calc (Audio Stretching) 194
- Calc Indicator 274, 434, 439
- Catch Zone Size (Neptune) 937
- CC Assign (External MIDI Instrument device) 828
- CF-101 Chorus/Flanger 957
- Channel 8 & 9 Exclusive 779
- Channel Color 372, 1031
- Channel Strips
  - Sort Selected Device Groups 308
- Chorus 957
- Chunk Trig (Kong) 805
- Clear All Keyboard Remote 1032

- Clear Insert FX 394
- Clear Keyboard Control Mapping 1032
- Click
  - Button 117
  - Level 117, 129
- Click and Pre-count 128
- Clip Color 177, 1031
- Clip Level Handle (Audio Clips) 200
- Clip Overview
  - Audio Clips 199
  - Note Clips 236
- Clip Safe (with Propellerhead Balance Interface) 133
- Clipping (Audio) 70
- Clips
  - About Overlapping... 176
  - Adjust Alien Clips to Lane 175
  - Alien 175
  - Coloring 177
  - Creating 164, 240
  - Cropping 1030
  - Cut, Copy and Paste 176
  - Deleting 168
  - Duplicating 176
  - Duplicating Parts of Clips 179
  - Joining 179, 1030
  - Length Display 165
  - Level and Fades in Audio Clips 167
  - Masking Recordings or Events in... 170
  - Match Values 182
  - Moving 174
  - Muting 181, 1030
  - Naming 177, 1030
  - Nudging 174
  - Position Display 165
  - Remove Label from... 177
  - Renaming 177
  - Repeating 177
  - Resizing 169
  - Scaling Tempo 172
  - Selecting 164
    - Multiple 165
  - Selecting with the Arrow Keys 166
  - Splitting 178
- Clock Source (Preferences - Audio) 1038
- Close (Songs) 424, 1011
- Close Button (In Comp Editor) 200
- Combi Patches 538
- Combinator
  - Adding Devices 543
  - Bypass All FX 547
  - Combining Devices 539
  - Creating 539
  - Creating by Browsing Patches 539
  - Creating New Devices 543
  - External Routing 541
  - Insertion Line 543
  - Internal CV Connections 555
  - Key Mapping 550
  - Receive Notes 551
  - Run Pattern Devices 547
  - Select Backdrop 548
  - Setting Velocity Ranges for Devices 551
  - Uncombining Devices 546
  - Using Modulation Routing 552
  - Using the Programmer 549
- Commit to Groove 487, 1029
- Comp Clips in the Comp Editor (Audio Clips) 201
- Comp Row 200, 202
  - Adjusting Level 209
  - Adjusting Recording Offset 210
  - Cut, Copy and Paste 209
  - Deleting 208
  - Duplicating 208
  - Level Matching 230
  - Moving 208
  - Selecting in a Single Take clip 206
  - Selecting in Comp Mode 207
  - Transpose Matching 230
- Comp Row Handle (Audio Clips) 200
- Comp Row Level Fader (Audio Clips) 200
- Comp Rows
  - Transpose 226
- Comp-01 Compressor 975
- Compatible EQ (Mixer 14-2) 560
- Comping Audio 219
- Compressor (Kong) 817
- Computer
  - Authorizing 27
  - Deauthorizing 28
- Context Menus 53
  - For Channels Strips 55
  - For Devices 54
  - For Parameters 53
  - For the Main Mixer 56
  - For the Rack 56
  - For the Sequencer 56
- Control Panel (Preferences - Audio) 1039
- Control Surfaces
  - Adding and setting up 1040

- Convert Pattern Automation to Notes 273
  - Matrix 988
  - Redrum 775
- Convolution Algorithm (RV7000 Mk II) 895
- Copy Channel Settings 371
- Copy Devices and Tracks 310
- Copy Loop to Track 1025
- Copy Loop To Track (Dr. Octo Rex) 745
- Copy Original Channel Settings 442
- Copy Parameters to Selected Zones 1022
- Copy Patch 326
- Copy Pattern 981
- Copy Pattern to Track 1025
  - Matrix 988
  - Redrum 775
- Copy Zones 706
- Correction Speed (Neptune) 938
- CPU Usage Limit 69, 1034
- Create Audio Track 93
- Create Audio Track (Create Menu Item) 1047
- Create Button (in Browser) 198
- Create Effect 341
- Create Effect... (Create Menu Item) 1047
- Create Instrument 341
- Create Instrument... (Create Menu Item) 1047
- Create Menu 1047
- Create Send FX 396
- Create Send FX (Create Menu Item) 1047
- Create Track for... 1027
- Create Velocity Crossfades 1024
- Crop (Edit Sample Window) 460
- Crop Events to Clips 172, 1030
- Cross-browsing
  - Patches 340
  - Samples and REX files 341
- Crossfade Loop 464
- Crossfades (Audio Clips) 222
  - Adding 215
  - Matching 230
- CS 133
- Curve (Matrix) 984
  - About 978
- Cut Crossfade Zones (Audio Clips) 201
- Cut Devices and Tracks 310
- Cut Handles (Audio Clips) 202
- Cut Lines (Audio Clips) 202
- Cut Pattern 981
- Cut Row (Audio Clips) 201
- Cut Tool (Audio Clips) 111, 205
- Cuts
  - Adding (Audio Clips) 214
  - Deleting (Audio Clips) 216
  - Moving (Audio Clips) 216
- CV
  - About 350
  - Merging 961
  - Routing 360
  - Splitting 964
  - Trim Knobs 360
  - vs. Gate 984
- D**
  - D-11 Foldback Distortion 967
  - DDL-1 Delay Line 956
  - Decay/Gate Switch 777
  - Default Song 424, 1034
  - Delay 956
    - The Echo 902
  - Delete Track for... 1027
  - Delete Unused Recordings (Audio Clips) 210
  - Delete Unused Samples 673
  - Demo Mode 29
  - Demo Songs
    - Opening 423
  - Detach Main Mixer
    - Mac OS X Version 1054
    - Windows Version 1052
  - Detach Rack Window
    - Mac OS X Version 1054
    - Windows Version 1052
  - Device Groups
    - About 300
    - Cut, Copy and Paste 310
    - Duplicating 310
    - Sort Selected Device Groups 308

- Devices
  - Creating 302
  - Cut, Copy and Paste 310
  - Deleting 306
  - Deleting with their Tracks 98
  - Device Groups 300
  - Disconnecting 359
  - Duplicating 310
  - Duplicating and Copying with their Tracks 99
  - Folding/Unfolding 49, 312
  - Moving to a New Rack Column 308
  - Naming 311
  - Re-ordering in the Rack 306
  - Replacing 309
  - Re-routing in the Rack 308
  - Routing 353
  - Routing Master Keyboard Input to 304
  - Selecting 304
  - Sort Selected Device Groups 308
- Diffusion (The Echo) 905
- Direct Out (on Mix Channel and Audio Track Devices) 417
- Dirt (Pulveriser) 864
- Disable Stretch (Audio Clips) 274
- Disconnect
  - Cables 359
  - Device 355, 359
- Distortion
  - D-11 967
  - Scream 4 854
- Dither (Audio Export) 438, 443
- Dr. Octo Rex
  - About 740
  - Adding REX Loops 743
  - Copy Loop To Track 745
  - Editing Slices 748
  - Panel Parameters 754
  - Playing from Sequencer 745
  - Playing REX Loop Slices 744
  - Playing REX Loops 742
- Dr.Rex Loops
  - Opening in Dr. Octo Rex 741
- Drop to Propellerhead 444
- Drum Assignment (Kong) 789
- Drum Edit Mode (Note Clips) 238
- Drum Output (Kong) 794
- Drum Room Reverb (Kong) 816
- Dub
  - On Instrument Tracks 150
- Dub Button (Transport Panel) 119
- Ducking
  - Alligator 880
  - The Echo 908
- Duplicate Devices and Tracks 310, 1016
- Dynamics 771
- E**
  - E button (EQ in the TTM Mixer) 377
  - ECF-42 Envelope Filter 968
  - Edit Focus 384
  - Edit Menu 1015
  - Edit Mode
    - For Automation Clips 232
    - For Note Clips 232
  - Edit Remote Override Mapping 502
  - Editing
    - Buttons 48
    - Buttons (Multi Mode) 49
    - Display Values 50, 51
    - Faders and Sliders 48
    - Knobs 47
  - Effect Combi Patches 392
  - Effects 302
    - Creating 341
    - Recording with... 418
  - Empty (Default Song) 1034
  - Enable Blocks 1051
  - Enable Keyboard Control (Remote) 507
  - Enable Loop Playback (Dr. Octo Rex) 753
  - Enable Pattern Section 775
  - Enable Pattern Section (Redrum) 773
  - Enter Edit Mode 1051
  - Envelope Controlled Filter 968
  - Envelopes 588
  - EQ
    - Main Mixer 377
    - Mixer 14-2 559
    - Parametric 976
    - RV7000 Mk II Advanced Reverb 898
  - Eraser Tool 111
  - Exit (Windows) 1014
  - Exit Edit Mode 1051
  - Explode 259
  - Export Insert FX patch 1013
  - Export Loop as Audio File 438
  - Export MIDI File 431, 1013
  - Export REX as MIDI File 1014
  - Export Song as Audio File 438
  - Ext Mod (Subtractor) 596
  - External Effect (Kong) 824
  - External MIDI Instrument 826
    - Setting up 826
  - External Sync Offset 519

## F

Factory Sound Bank 327  
Fade Handles (Audio Clips) 200  
Fade In/Out (Edit Sample Window) 461  
Fade In/Out Displays (Audio Clips) 165  
Fade In/Out Handles (Audio Clips) 167  
Fast Forward Button (Transport Panel) 118  
Favorite Lists (Browser) 336  
Favorites Lists 336  
FFT (Vocoder) 912  
File Formats 346  
Filter  
    Dr. OctoRex 757  
    Effect Device 968  
    Malström 647  
    NN-19 677  
    NN-XT 730  
    Pulveriser 865  
    Subtractor 583  
Filter (Kong) 818  
Filters To Dynamics Sidechain (Main Mixer) 375  
Flam (Redrum) 772  
Flanger 957  
FM 581  
Folding/Unfolding Device Panels 49  
Follow Selection (in Spectrum EQ) 379  
Follow Song 1051  
Follower (Pulveriser) 867  
Formant (Neptune) 942  
Freezing Pitch Adjustments 951

## G

Gain Knob (Main Mixer) 373  
Gain Reduction CV Out 376  
Gate  
    About 350  
    Programming in Matrix 983  
    Routing 360  
    vs. CV 984  
Gate (Alligator) 872  
Gate (Matrix) 978  
Gate (RV7000 Mk II Advanced Reverb) 899  
Gate mode (Redrum) 777  
Get Groove From Clip 1029  
Global Shuffle 476  
Go To Left/Right Locator (Transport Panel) 119  
Go to Product Page... 1032, 1056  
Go To Track for... 1027

## Groove

Assigning to Note Lanes 484  
Committing to 1029  
Creating from Clips 488  
Extracting 1029  
Factory Patches 490  
Making Permanent 487  
Mixer Parameters 475  
Settings in Tool Window 481  
Groove Button (Transport Panel) 116  
Group Selected Zones 1023  
Groups  
    NN-XT 706

## H

Hand Tool 113  
Hardware Device 66  
Hardware Interface 532  
Help 1056  
Help Menu 1056  
Hide All Cables 352  
Hide Auto-Routed Cables 352  
Hide Browser  
    Mac OS X Version 1054  
    Windows Version 1052  
Hide On-screen Piano Keys  
    Mac OS X Version 1055  
    Windows Version 1053  
Hide Recording Meter  
    Mac OS X Version 1055  
    Windows Version 1053  
Hide ReGroove Mixer  
    Mac OS X Version 1055  
    Windows Version 1052  
Hide Tool Window  
    Mac OS X Version 1055  
    Windows Version 1053  
Hide Transport Panel  
    Mac OS X Version 1055  
    Windows Version 1052  
High Quality Interpolation  
    NN-XT 693  
    Redrum 780  
Hit Type (Kong) 790  
Host Application (ReWire) 511

## I

ID8 Instrument Device 570  
    Controlling Sounds 571  
    Selecting Sounds 571

- Ignition Key
  - Authorizing 27
  - Deauthorizing 28
- Ignition Key hardware
  - Running Reason with... 28
- Import Audio File... 435
- Import MIDI File 430
- Improved EQ (Mixer 14-2) 560
- Impulse Response Samples
  - Loading 896
  - Sampling Your Own 897
- Init Patch
  - Kong 788
- Init patch
  - Redrum 767
  - Subtractor 574
- Input Focus Button (Hardware Interface) 520
- Input Level
  - Setting for Audio Track 133
- Input Meter (Audio Tracks) 103
- Input Meter (Effect Devices) 954
- Insert Bars Between Locators 184, 1027
- Insert FX
  - Adding 392
  - Copying Between Mixer Channels 395
  - Deleting 394
  - Editing and Saving 393
- Inspector
  - Audio Editing in the... 228
  - Automation Editing in the... 277
  - Note Editing in the... 277
- Instrument Tracks
  - Creating 95
  - Record Enabling 126, 127
  - Setting Up 148
- Instruments
  - Creating 341
- Interpolation
  - Dr. OctoRex 761
- Invert
  - Pattern (RPG-8) 1002

**J**

- Join Clips 179, 1030

**K**

- Keep Events in Clip While Editing 244, 249, 250, 252
- Keep Pitch (The Echo) 904
- Key Commands
  - Syntax in Manual 24
- Key Edit Mode (Note Clips) 238

- Key Maps
  - NN-19 672
  - NN-XT 703
- Key Zones
  - NN-19 670
  - NN-XT 689
- Keyboard Control (Remote) 507
  - Editing 507
- Keyboard Control Edit Mode (Remote) 507, 1048
- Keyboard Shortcuts
  - Transport Panel 119
- Keyboards (MIDI) 1040
- Keys (Matrix) 978
- Keys Button (Transport Panel) 116
- Kit Patches 786
- Kit Patches (Kong) 786
- Knobs 47
- Kong 786
  - Copying and Pasting Drums 790
  - MIDI Note Assignment 787

**L**

- Lag (Pulveriser) 866
- Lanes
  - Adding/Creating 106
  - Deleting 108
  - Muting 110
- Latency 75
  - Compensation 525
  - Optimization and Reduction 524
- Legato Adjustments (Tool Window function) 246
- Length Display (Clips) 165
- Level Display (Audio Clips) 165
- Level Handle (Audio Clips) 167
- Level/Pan CV (on Channel Strip) 383
- Levels (Audio) 70
- LFO Sync
  - Dr. OctoRex 760
  - NN-19 680
  - Subtractor 592
- Line 6 Amp Tones 846
- Line 6 Amps
  - About 846
- Line Mixer 6-2
  - About 566
  - AUX Send and Return 567
  - Channel Parameters 566
  - Connections 567
- Line Tool (Velocity Editing) 261
- Live Mode (Neptune) 934
- Load Button (in Browser) 333
- Load Default Sound in New Devices 1035



- Load Last Song On Startup 423
- Locations and Favorites (Browser) 336
- Locator Displays (Transport Panel) 119
- Loop Locators 115
- Loop Mode 130
  - Recording Audio Track in... 139
  - Recording Instrument Track in... 148
  - Recording Parameter Automation in... 156
- Loop Mode (Edit Sample Window) 462
- Loop On/Off Button (Transport Panel) 119
- Loop Trig (Kong) 804
- Loops
  - In Drum Samples 778
  - In Samples 674
- Low BW 683
- Low BW (Dr. OctoRex) 761
- Low Freq (Neptune) 934, 944

**M**

- Magnifying Glass Tool 112
- Main Mixer
  - Channel Strip Sections 373
  - Coloring Channel Strips 372
  - Compressor Sidechaining 416
  - Control Room Out (in Master Section) 390
  - Copy Channel Settings 371
  - Copying and Duplicating Channel Strips 370
  - Dynamics Section 374
  - Edit Focus 384
  - EQ Section 377
  - Fader Section (in Master Section) 390
  - Fader Section (on channel strip) 383
  - FX Return Section (in Master Section) 389
  - Input Section 373
  - Insert FX Section (in Master Section) 388
  - Insert FX Section (on Channel Strip) 381
  - Level/Pan CV 383
  - Master Compressor 386
  - Master Section 385
  - Moving Channel Strips 370
  - Naming Channel Strips 371
  - Navigating in the... 366
  - Overview 362
  - Remote Controlling 411
  - Reset Channel Strip Settings 371
  - Selecting Channels 369
  - Send FX Section (in Master Section) 387
  - Send FX Section (on Channel Strip) 382
  - Showing/Hiding Channel Strip Sections 367
  - Signal Path Section 373
- Main Mixer Area 36

- Malström
  - About 640, 930
  - Filters 647
  - Grainables 643
  - Modulators 645
  - Oscillators 642
  - Routing 653
  - Routing external audio to 663
  - Shaper 651
- Manual Rec 127
- Mapping Variations (Remote) 497
- Master Compressor (Main Mixer) 386
- Master FX Parameter 1 & 2 815
- Master Keyboard Input 90, 304, 1042
  - Bypassing 522
- Master Section Device 365
- Master Section Mixer Strip 365
- Master Tune 70, 1036
- Matrix
  - About 978
  - Application Examples 989
  - Programming 979
- MClass Compressor 841
- MClass Effects
  - About 838
- MClass Equalizer 839
- MClass Maximizer 844
- MClass Stereo Imager 840
- Melody (Stretch and Transpose Type) 223
- Merge Note Lanes on Tracks 181, 1029
- Metronome (Click) 128
- MIDI
  - Send All Notes Off 827
- MIDI CC Automation (External MIDI Instrument device) 828
- MIDI Clock 516
- MIDI Controller Recording
  - from Control Surface 829
  - from External Instrument 830
  - from External MIDI Instrument Device 828
- MIDI Files
  - Exporting 431, 1013
  - Importing 430
- MIDI Focus Button (Hardware Interface) 520
- Minimize (Mac OS X) 1054
- Missing Device (Rack Extensions) 318
- Missing Line 6 Models 852
- Missing Sounds 344
  - Window 422

- Mix Bus 399
    - Creating 399
    - Deleting 401
    - Rerouting 401
  - Mix Channel Device 364
  - Mix Channel Strip 364
  - Mixdown
    - Recording in the Sequencer 144
  - Mixer 14-2
    - About 558
    - Auxiliary Return Section 561
    - Chaining 563
    - Channel Strip 558
    - Channel Strip Controls 559
    - Connections 561
    - Signal Flow 560
  - Monitor Button (Audio Tracks) 102
  - Monitoring Audio Tracks 134
  - Mono
    - Considerations 528
  - Mono or Stereo on Audio Track 93, 132
  - More Audio (Hardware Device) 534
  - Mouse Knob Range 47, 1033
  - Mouse Mode (On-screen Piano Keys) 61
  - MultiCore Audio Rendering 69
  - Mute
    - Mixer 566
    - Mixer 14-2 559
    - Redrum 776
  - Mute (M) Buttons 101
  - Mute Clips 181, 1030
  - Mute Tool 112
- N**
- Navigating in the Song Window 40
  - Neptune
    - Mixer Section 946
    - Panel Parameters 943
    - Pitch Display 932
    - Pitch Processing of Live Audio 933
    - Pitch Processing of Recorded Audio Tracks 932
    - Setting up 932
  - New (Song) 424, 1011
  - New Devices get Browse Focus 1035
  - New Dub
    - On Audio Tracks 140
  - New from Template (Songs) 425, 1011
  - NN-19
    - About 666
    - Loading Samples 669
    - Parameters 676
  - NN-Nano Sampler (Kong) 800
  - NN-XT
    - About 688
    - Group Parameters 724
    - Groups 706
    - Loading Samples 690
    - Main Panel 692
    - Remote Editor Panel 695
    - Sample Parameters 722
    - Synth Parameters 726
    - Velocity Ranges 717
  - Noise Generator (Kong) 813
  - Normal Waveform Zoom Mode 46
  - Normalize (Edit Sample Window) 460
  - Note Clips
    - Merging Note Lanes on Tracks 181
    - Opening for Editing 233
  - Note Edit Lane (Note Clips) 236
  - Note Edit Mode Selector (Note Clips) 236
  - Note Edit Modes 237
  - Note Lanes
    - Adding/Creating 106
    - Deleting 108
    - Duplicating/Copying 109
    - Moving 109
    - Muting 110
  - Note Lengths (Tool Window function) 246
  - Note To Slot (Dr. Octo Rex) 751
  - Note Velocity (Tool Window function) 262
  - Notes
    - Altering 250
    - Cut, Copy and Paste 252
    - Deleting 245
    - Drawing 243
      - Outside a Closed Clip 244
      - Outside an Open Clip 244
    - Duplicating 251
    - Editing Velocity 261
    - Extracting to Lanes 257
    - Matching 278
    - Moving 248
      - Outside or Between Clips 249
    - Nudging 250
      - Outside an Open Clip 250
    - Pasting Outside an Open Clip 252
    - Quantizing 253
      - Random 255
      - To Shuffle 255
    - Recording in the Sequencer 148
      - In Loop Mode 148
      - Over Existing Clips 149
    - Resizing 245
    - Selecting 242
    - Transposing 249, 256

- Nudging
  - Note Positions 250
  - Recordings (Audio) 210
- Nudging Slices 196
- Nurse Rex Loop Player (Kong) 804
- O**
- Offset R
  - Delay (The Echo) 904
  - Feedback (The Echo) 905
- On-screen Piano Keys Window 61
  - Opening 60
  - Resizing 60
- Open (Songs) 422, 1011
- Open Demo Song 423, 1011
- Open Song Windows List
  - Mac OS X Version 1055
  - Windows Version 1053
- Optimizing RAM Usage 530
- Optimizing Songs 528
- Optimizing Your Computer 526
- Options Menu 1048
- Orphan Audio Streams 430
- Output Bus 399
  - Creating 399
  - Deleting 401
  - Rerouting 401
- Overdrive/Resonator (Kong) 821
- Overdubbing Audio in the Sequencer 140
- P**
- P Button (Mixer 14-2) 559
- Pad Group (Kong) 792
- Pad Settings (Kong) 789, 791
- Pads (Kong) 787
- Parallel Channels (Parallel Processing) 403
- Parallel Output Bus 404
- Parameter Automation
  - Record Enabling 128
  - Recording in the Sequencer 155
    - In Loop Mode 156
    - On Multiple Tracks 158
    - Over Existing Clips 157
- Parameter Automation Lanes 236
  - Adding/Creating 107
  - Deleting 108
  - Folding/Unfolding 104
  - Muting 110
- Parameter Automation Track
  - Creating 96
- Parametric EQ 976
- Parametric EQ (Kong) 818
- Paste Devices and Tracks 310
- Paste Patch 326
- Paste Pattern 981
- Paste Zones 706
- Patch Cables 353, 357
- Patches
  - About 320
  - Alligator 872
  - Browsing 1018
  - Copy and Paste 326
  - Cross-browsing 340
  - Exporting 1013
  - File Formats 346
  - Initializing 326, 1018
  - Kong 786
  - Line 6 Amps 846
  - Loading 321, 342
  - Missing Sounds 323, 1019
  - NN-XT 690
  - Pulveriser 862
  - Redrum 766
  - RV7000 Mk II 888
  - Saving 325
  - Scream 4 854
  - Subtractor 574
  - The Echo 902
- Pattern Automation
  - Deleting Clips 272
  - Drawing 271
  - Editing 270
  - Moving, Resizing and Duplicating Clips 272
  - Record Enabling 128
  - Recording in the Sequencer 159
- Pattern Automation Lanes
  - Creating 107
  - Deleting 109
- Pattern Changes
  - Converting Patterns to Notes 273
- Pattern Controlled Filter - an Example 969
- Pattern Shuffle 772
- Patterns
  - Alligator 874
  - Cut, Copy and Paste 981
  - Muting in Matrix 980
  - Muting in Redrum 773
  - Redrum 768
  - Running 768
  - Selecting in Matrix 980
  - Selecting in Redrum 769
- PEAK (Big Meter) 535
- Pencil Tool 111
  - Drawing Notes 243

- PEQ-2 EQ 976
- Performance Controller Automation
  - Creating New Lanes 268
  - Deleting Lanes 268
  - Editing 267
  - Recording in the Sequencer 153
    - Over Existing Clips 154
- Performance Controller Automation Selector 236
- Performance Controller Edit Lanes (Note Clips) 236
- PH-90 Phaser 972
- Phase Controls (Subtractor) 579
- Phaser 972
- Physical Bass Drum (Kong) 809
- Physical Snare Drum (Kong) 809
- Physical Tom Tom (Kong) 809
- Ping-Pong Delay (The Echo) 905
- Pitch (in Tool Window) 256
- Pitch Adjust (Neptune) 933
- Pitch Adjustments
  - Freezing on Audio Track 951
- Pitch Bend Range (Kong) 799
- Pitch Correction
  - Automatic 935
  - Manual via MIDI 939
- Pitch Processing of Live Audio (Neptune) 933
- Pitch Processing of Recorded Audio Tracks (Neptune) 932
- P-LAN signals 351
- Play Button (Transport Panel) 118
- Play in Background (Preferences - Audio) 1039
- Polyphony
  - Dr. OctoRex 761
  - Malström 658
  - NN-19 683
  - NN-XT 724
  - Subtractor 596
- Position Display (Clips) 165
- Post-fader Sends (Mixer 14-2) 559
- PPM (Big Meter) 535
- Pre-Align (ReGroove Mixer) 479
- Preferences
  - Advanced Control 1044
  - Audio 1036
  - General 1033
  - Keyboards and Control Surfaces 1040
  - Language 1046
- Preserve Expression (Neptune) 939
- Preview (Dr. Octo Rex) 743
- Program Change (External MIDI Instrument device) 827
- Programmer CV In (Combinator) 553, 555

- Pulveriser 862
  - Dirt 864
  - Filter 865
  - Follower 867
  - Squash 864
  - Tremor (LFO) 866

## Q

- Q Rec button 256
- Q Record Button (Transport Panel) 116
- Quantize 1031
  - Audio 196
  - Random 255
  - To Shuffle 255
- Quantize (Tool Window) 253
- Quantize Button (Transport Panel) 116
- Quantize Notes During Recording 256
- Quantize Value (Transport Panel) 116
- Quit (Mac OS X) 1010

## R

- Rack
  - Creating New Rack Columns 308
  - Detaching 299
  - Device Groups 300
  - Flipping Around 357
  - Navigating 298
  - Resizing 299
  - Scrolling in the... 298
- Rack Area 37
- Rack Extensions 314
  - Deleting 315, 1052, 1054
  - Installing 315
  - Managing 315
  - Missing Device 318
  - Trying and Buying 314
  - Using 316
- Rack Extensions (Window Menu)
  - Mac OS X Version 1054
  - Windows Version 1052
- RAM 530
- Random Sequencer Pattern 1026
- Random Timing (ReGroove Mixer) 483
- Randomize
  - Pattern (Redrum) 774
  - Pattern (RPG-8) 1002
- Randomize Notes (in Tool Window) 257
- Randomize Pattern (Matrix) 987
- Rattler (Kong) 820
- Razor Tool 111
- RCY files 741
- Reason Menu (Mac OS X) 1010

- Record Automation as Performance Controllers 1051
- Record Automation into Note Clip 154, 1051
- Record Button (Transport Panel) 118
- Record Enable Button (Audio Tracks) 102
- Record Enabling
  - Audio Track 125
  - Instrument Track 126, 127
  - Parameter Automation 128
  - Pattern Automation 128
  - Sequencer Tracks 124
- Recording in the Sequencer
  - Audio 137
    - From Mix Channels 142
    - In Loop Mode 139
    - Over Existing Clips 141
  - General Procedure 131
  - Mixdown 144
  - Notes 148
    - In Loop Mode 148
    - Over Existing Clips 149
  - Parameter Automation 155
    - In Loop Mode 156
    - On Multiple Tracks 158
    - Over Existing Clips 157
  - Pattern Automation 159
  - Performance Controller Automation 153
    - Over Existing Clips 154
  - Tempo Automation 160
  - Undoing 132
- Recording Latency Compensation 525
- Recording Meter Window 136
- Recording Offset (Audio Clips) 210
- Recording Offsets
  - Matching 229
- Recording with Effects 418
- Recordings
  - Nudging 210
- ReCycle 740
- Redo 57, 1015
  - Multiple 57
- Redrum
  - Individual Outputs 781
  - MIDI Notes for 780
  - Parameters 776
  - Patches 766
  - Programming Patterns 768
- Reduce Cable Clutter 351
- ReFills
  - About 327
- Registering Reason 26
- ReGroove Mixer
  - Assigning to Note Lanes 484
  - Creating ReGroove Patches 488
  - Factory Patches 490
  - Making Grooves Permanent 487
  - Parameters 475
  - Settings in Tool Window 481
- Reload Samples 1021
- Remote
  - About 492
  - Adding a Control Surface/Keyboard 493
  - Basics 496
  - Example Setups 495
  - Locking a Control Surface 498
  - Mapping Variations 497
  - Standard vs Remote Override Mapping 497
  - Surface Locking 498
  - Surface Locking Dialog 498
  - Unlocking a Control Surface 500
- Remote Base Channel
  - Setting 411
- Remote Override
  - Additional 505
    - Assigning 506
  - Edit Mode 501, 1049
  - Mapping 502
- Remove Bars Between Locators 184, 185, 1027
- Remove Labels From Clips 177
- Replacing Devices 309
- Reset (Automation) 157
- Reset Band Levels (Vocoder) 918
- Reset Device 326, 1018
- Resizing Areas in Song Window 43
- Resolution (Redrum Pattern) 771
- Reverb
  - RV-7 965
  - RV7000 Mk II 888
- Reverse (Edit Sample Window) 460
- Revert 323
- Revert Slices 198
- Rewind Button 118
- ReWire
  - Audio Routing in Host 513
  - Audio Routing Preparations in Reason 512
  - Converting ReWire Channels to Audio Tracks 514
  - Latency 76
  - MIDI Routing in Host 513
  - Setting Up 511
  - Synchronization to Host 511
  - Transport and Tempo Controls 512
- REX Edit Mode (Note Clips) 239

- REX Files
    - Auditioning (in the Browser) 339
    - Loading 342
  - REX files 347
    - Loading in Dr.Rex 741
    - Loading in NN-19 668
    - Loading in NN-Nano 800
    - Loading in NN-XT 691
    - Loading in Nurse Rex Loop Player 804
    - Loading in Redrum 767
  - REX Loops
    - Creating Sequencer Notes 745
    - Editing Slices 748
    - Editing Sound 754
    - Loading 743
    - Playing in Dr. Octo Rex 742, 744
  - Ring Modulation (Subtractor) 582
  - Ring Modulator (Kong) 819
  - Roll (The Echo) 903
  - Root and Scale (Neptune) 935
  - Routing (Cables)
    - Automatic 353
    - Manual 357
  - RPG-8
    - About 992
    - Arpeggiator parameters 999
    - Arpeggio Notes to Track 997
    - MIDI-CV Converter Parameters 998
    - Setting up 993
  - Ruler 115
  - Run button 770
  - Run Button (Redrum) 768
  - Run with Internet Verification 27
  - RV-7 Digital Reverb 965
  - RV7000 Mk II Advanced Reverb 888
- S**
- S1/S2 controls (Redrum) 776
  - Sample Rate
    - For Playback 527
    - Settings 68
  - Samples
    - Auditioning (in the Browser) 339
    - Browsing 1019
    - Cropping 460
    - Cross-browsing 341
    - Crossfading 464
    - Deleting 466
    - Duplicating 468
    - Editing 456
    - Exporting 469
    - Extracting from Self-contained Songs 428
    - Fading In/Out 461
    - File Formats 346
    - Importing 342
    - Including in Self-contained Songs 427
    - Kong 785
    - Looping 462
    - Missing 344
    - NN-19 669
    - NN-XT 697
    - Normalizing 460
    - Redrum 765
    - Renaming 464
    - Reversing 460
    - Saving 464
    - Sampling 451
      - About 448
      - Kong 798
      - Setting up 449
    - Save (Songs) 425, 1012
    - Save Device Patch As... 1013
    - Scale Memory (Neptune) 935
    - Scale Tempo
      - Audio Clips 223
    - Scale Tempo (Tool Window function) 260
    - Scratch Disk Folder 429
    - Scream 4 854
    - Scroll to Connected Device 352
    - Scrolling and Zooming with Wheel Mouse 46
    - Scrolling in the Song Window 44
    - Search (in Browser) 342
    - Segment Focus Indicator (Audio Clips) 201
    - Segments (Audio Clips) 201
      - Adding 215
    - Select All in Device Group 306
    - Select Slice Via MIDI (Dr. OctoRex) 748
    - Selection Tool 111
    - Self-contain Samples When Loading From Disk 1035
    - Self-contained Songs 427

- Send FX
  - Chaining from Devices to Main Mixer 414
  - Creating 396
  - Deleting 398
  - Editing and Saving 398
  - Muting 398
- Send Out (Redrum) 776
- Sends
  - Mixer 14-2 559
  - Redrum 776
- Sequencer
  - Adjust Alien Clips to Lane 175
  - Bypassing Master Keyboard Input 522
  - Inspector 228, 277
- Sequencer Area 38
- Sequencer Tools (Tool Window) 241
- Set Loop (Edit Sample Window) 463
- Set Loop to Selection 1031
- Set Loop to Selection and Start Playback 1031
- Set Root Notes from Pitch Detection 1023
- Set Sample Start/End (Edit Sample Window) 459
- Shift
  - Pattern (Matrix) 987
  - Pattern (Redrum) 774
  - Pattern (RPG-8) 1002
- Show Browser
  - Mac OS X Version 1054
  - Windows Version 1052
- Show For Selected Devices Only (Cables) 352
- Show Navigators 40, 1050
- Show On-screen Piano Keys
  - Mac OS X Version 1055
  - Windows Version 1053
- Show Parameter Value Tool Tip 1034
- Show Recording Meter
  - Mac OS X Version 1055
  - Windows Version 1053
- Show ReGroove Mixer
  - Mac OS X Version 1055
  - Windows Version 1052
- Show Tool Window
  - Mac OS X Version 1055
  - Windows Version 1053
- Show Transport Panel
  - Mac OS X Version 1055
  - Windows Version 1052
- Shuffle
  - Global 476
  - ReGroove Mixer 478
  - Setting for Pattern Devices 476
- Shuffle (Redrum) 772
- Sidechaining (Main Mixer Compressor) 416
- Signal Flow Graphs (on Effect Devices) 955
- Signal Paths
  - Audio Track 73
  - Instrument Track 74
- Signature Display (Transport Panel) 118
- Silence
  - Inserting in Audio Clips 214, 220
- Silence Row (Audio Clips) 202
- Single Take Clips in the Comp Editor (Audio Clips) 199
- Slice Edit Mode (Dr. Octo Rex) 750
- Slice Markers
  - Moving Several 195
  - Moving Single 194
- Slice Trig (Kong) 806
- Slices
  - About 740
  - Creating Sequencer Notes 745
  - Making Settings for (Dr. Octo Rex) 749
  - Nudging 196
  - Reposition Slice Markers 194
  - Selecting 192, 748
  - Stretching 194
- Slide (ReGroove Mixer) 478
- Small Waveform Zoom Mode 46
- SMF (Standard MIDI Files) 430
- Snap 114
- Snap Sample Start/End To Transients (Edit Sample Window) 459
- Solo
  - Mixer 566
  - Mixer 14-2 559
  - Redrum 776
- Solo (S) Button (in Sequencer) 101
- Song End Marker 115
- Song Information 1012
  - Including 426
- Song Position Display (Transport Panel) 117
- Song Position Pointer 115
- Song Samples Location (in Browser) 454
- Song Window 34
  - Navigating in the... 40
  - Resizing Areas 43
  - Scrolling in the... 44

- Songs
    - Closing 424, 1011
    - Creating 424, 1011
    - Creating New from Template 425, 1011
    - Default... 424
    - Exporting as Audio Files 438
    - File Formats 346
    - Opening 342, 422, 1011
    - Optimizing 528
    - Saving 425
    - Self-contained... 427
    - Setting up the Default Song 1034
    - Splash Picture 427
  - Sort Selected Device Groups 308
  - Sort Zones by Note 1023
  - Sort Zones by Velocity 1023
  - Soundfont files 348
  - SoundFonts
    - NN-19 670
    - NN-XT 691
  - Sounds
    - Missing 344
  - Source Device (In Device Group) 300
  - Speaker Tool 113
  - Speaker Tool (Audio Clips in Comp Editor) 205
  - Speaker Tool (Audio Clips Inline) 192
  - Spectrum Analyzer 378
  - Spectrum EQ Window 378
  - Spider
    - Audio Merger and Splitter 959
    - CV Merger and Splitter 961
  - Splash Picture 427
  - Split at Slices 197
  - Split Clips 178
  - Spread (Pulveriser) 866
  - Squash (Pulveriser) 864
  - Startup Song 423
  - Static Value (For Automated Parameter) 264, 265
  - Static Value Handles 236
  - Stay on Top 1052
  - Stems
    - Recording in the Sequencer 144
  - Stereo
    - Considerations 528
  - Stereo or Mono on Audio Track 93, 132
  - Stop Button (Transport Panel) 118
  - Stop Hit Type (Kong) 807
  - Stretch and Transpose Type 223, 274
  - Stretching Audio 194
  - Sub-Mix
    - Recording in the Sequencer 144
  - Sub-mixer 399
  - Subticks
    - In the Inspector 121
    - In the Position Display (Transport Panel) 117
  - Subtractor
    - About 574
    - External Modulation 596
    - Filter 583
    - Oscillators 575
    - Waveforms 576
  - Support Generators (Kong) 813
  - Surface Locking (Remote) 498, 1050
  - Swiping (Audio Clips) 215
  - Switch to Block View 1051
  - Switch to Song View 1051
  - Sync
    - About 516
    - Internal/MIDI Clock/ReWire/Send MIDI Clock 1048
    - Latency 519
    - Setting Up as Master 516
    - Setting Up as Slave 518
  - Synth Bass Drum (Kong) 811
  - Synth Hi-Hat (Kong) 812
  - Synth Snare Drum (Kong) 811
  - Synth Tom Tom (Kong) 811
- T**
- Tap Tempo Button (Transport Panel) 118
  - Tape Echo (Kong) 820
  - Template (Default Song) 1034
  - Template Songs 425
    - Creating Your Own 428
  - Tempo
    - Scaling 260
  - Tempo Automation
    - Drawing Events 273
    - Editing 273
    - Recording in the Sequencer 160
  - Tempo Data
    - In Exported Audio Files 439
    - In Imported Audio Files 434
  - Tempo Display (Transport Panel) 117
  - The Echo 902
    - Color Section 906
    - Delay Section 904
    - Diffusion 905
    - Ducking 908
    - Feedback Section 905
    - Mode 903
    - Modulation Section 907



- Thor
    - Assignable Controls 603
    - Oscillator section 608
    - Using the Programmer 604
  - Tie Switch (Matrix) 985
  - Time Position Display (Transport Panel) 117
  - Time Signature Automation 275
    - Deleting Clips 276
    - Moving, Resizing and Duplicating Clips 276
  - Toggle Rack Front/Rear 357, 1050
  - Tone Generator (Kong) 814
  - Tool Tips 52, 1034
  - Tool Window 41
  - Tool Window Sequencer Tools 241
  - Toolbar Tools 111
    - Alternate 113
    - Keyboard Shortcuts 115
  - Tracks
    - Coloring 100
    - Creating 93
    - Deleting 98
    - Duplicating and Copying 99
    - Folding/Unfolding 100
    - Moving 98
    - Muting 101
    - Naming 100
    - Record Enabling 124
    - Routing Master Keyboard Input to 90
    - Selecting 97
    - Soloing 101
    - Sort Selected Device Groups 308
    - Types 91
  - Transient Shaper (Kong) 816
  - Transport Panel
    - Keyboard Shortcuts 119
  - Transpose
    - Audio Clips 225
    - Audio Clips (in Tool Window) 256
    - Comp Rows 226
    - Notes 256
  - Transpose (Neptune) 940
  - Transpose (Semitones) (in Tool Window) 257
  - Transpose Display (Audio Clips) 165
  - Tremor (Pulveriser) 866
  - Trig Next Loop (Dr. Octo Rex) 742
  - Trigger Buttons (Redrum) 766
  - Trigger Notes while Editing 1034
  - Trim Knobs 360
  - Tuner
    - Using on Audio Track 135
  - Tuner Button (Audio Tracks) 102
  - Tuning 70
- 
- U**
    - UN-16 Unison 974
    - Unassigned Samples 465
    - Undo 57, 1015
      - Multiple 57
    - Unipolar Curves (Matrix) 984
    - Unison 974
    - Unmute Clips 1030
    - Use MultiCore Audio Rendering 69
    - Use MultiCore Audio Rendering (Preferences) 526
    - Utilities 302
  - V**
    - Velocity
      - Editing 261
    - Velocity Edit Lane (Note Clips) 236
    - Velocity Lane 261
    - View All
      - Mac OS X Version 1054
      - Windows Version 1052
    - View Main Mixer
      - Mac OS X Version 1054
      - Windows Version 1052
    - View Racks
      - Mac OS X Version 1054
      - Windows Version 1052
    - View Sequencer
      - Mac OS X Version 1054
      - Windows Version 1052
    - Vocal (Stretch and Transpose Type) 223
    - Vocoder
      - About 912
      - How it Works 912
      - Parameters 918
      - Setting up 913
      - Using as EQ 917
    - Voice Synth (Neptune) 942
    - VU (Big Meter) 535
    - VU Offset (Big Meter) 535
  - W**
    - Warping Audio 194
    - Waveform Zoom Mode 46
    - Wheel Mouse
      - Scrolling and Zooming with... 46
    - Wide Vibrato (Neptune) 934, 944
    - Window Menu
      - Mac OS X Version 1054
      - Windows Version 1052

## **Y**

Your Profile

Mac OS X 1010

Windows 1056

## **Z**

Zoom (Mac OS X) 1054

Zoom To Selection 46

Zooming in the Sequencer 45